



US00D875166S

(12) **United States Design Patent**  
**Beghelli**

(10) **Patent No.:** **US D875,166 S**

(45) **Date of Patent:** **\*\* Feb. 11, 2020**

(54) **PROJECTOR EMBEDDED IN WALLS AND CEILINGS**

D740,344 S \* 10/2015 Li ..... D16/225  
D750,691 S \* 3/2016 Hu ..... D16/230  
2004/0066495 A1\* 4/2004 Yu ..... G03B 21/14  
353/84

(71) Applicant: **BEGHELLI S.P.A.**, Monteveglio (IT)

(72) Inventor: **Gian Pietro Beghelli**, Monteveglio (IT)

(73) Assignee: **BEGHELLI S.P.A.**, Monteveglio (IT)

(\*\*) Term: **15 Years**

(21) Appl. No.: **29/637,554**

(22) Filed: **Feb. 20, 2018**

(30) **Foreign Application Priority Data**

Nov. 30, 2017 (EM) ..... 004528743-0001

(51) **LOC (12) Cl.** ..... **16-02**

(52) **U.S. Cl.**

USPC ..... **D16/230**

(58) **Field of Classification Search**

USPC ..... D16/221, 225, 230-231, 234; D21/514,  
D21/308, 362; D14/506, 508-509, 168,  
D14/195; D32/21; 353/119, 122

CPC ..... G03B 21/14; G03B 21/145; G03B 21/12;  
G03B 21/16; G03B 21/00; G03B 21/001;  
G03B 21/003

See application file for complete search history.

(56) **References Cited**

**U.S. PATENT DOCUMENTS**

6,598,977 B1\* 7/2003 Chen ..... G03B 21/14  
348/743  
D555,184 S \* 11/2007 Rodriguez, Jr. .... D16/225

**FOREIGN PATENT DOCUMENTS**

CN 304222215 \* 12/2016

\* cited by examiner

*Primary Examiner* — Wan Laymon

(74) *Attorney, Agent, or Firm* — Maier & Maier, PLLC

(57) **CLAIM**

The ornamental design for a projector embedded in walls and ceilings, as shown and described.

**DESCRIPTION**

FIG. 1 is a perspective view of a projector embedded in walls and ceilings;

FIG. 2 is a top view thereof;

FIG. 3 is a bottom view thereof;

FIG. 4 is a front view thereof;

FIG. 5 is a rear view thereof;

FIG. 6 is left side view thereof;

FIG. 7 is a right side view thereof; and,

FIG. 8 is bottom perspective view thereof.

The broken lines showing portions of the projector embedded in walls and ceilings form no part of the claimed design.

**1 Claim, 8 Drawing Sheets**

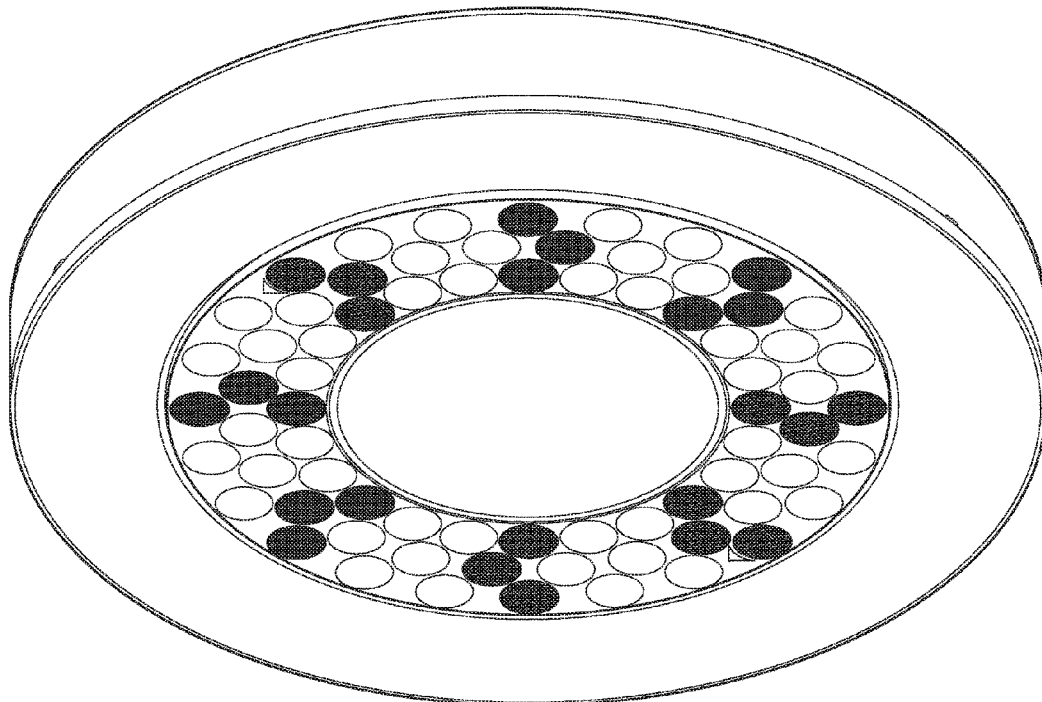

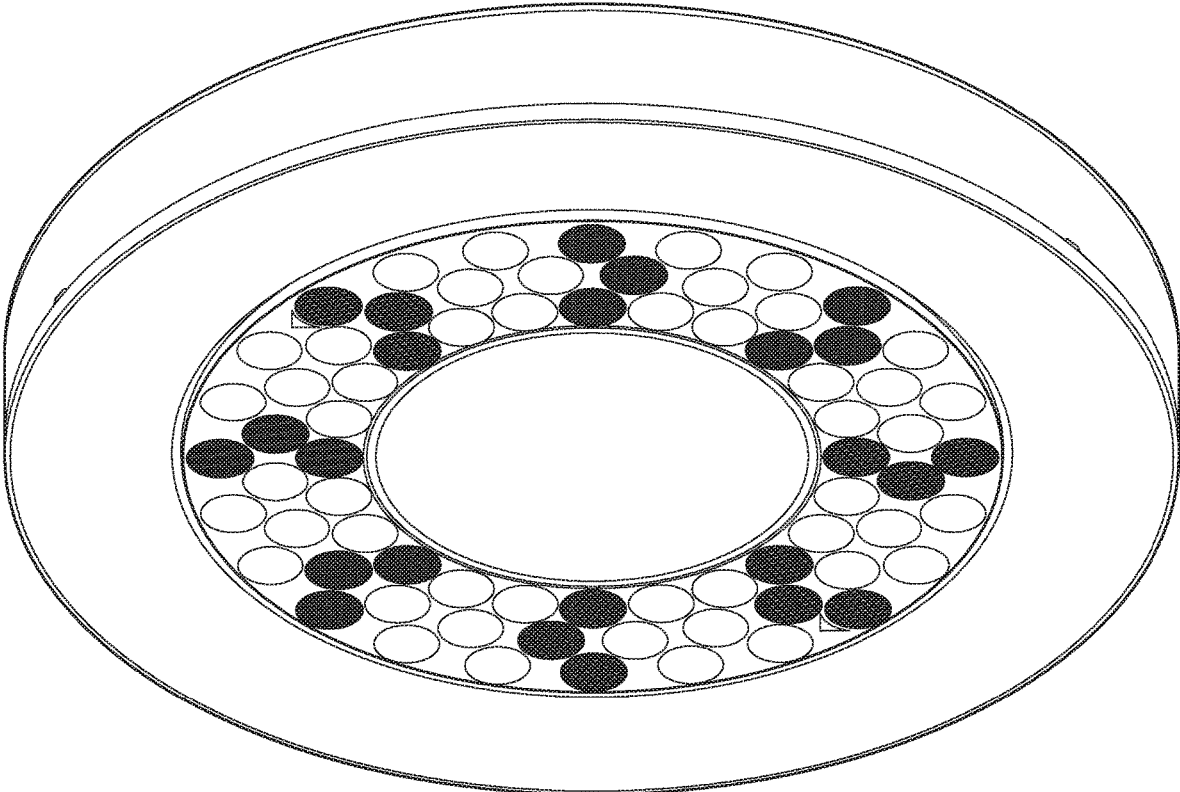

FIG. 1

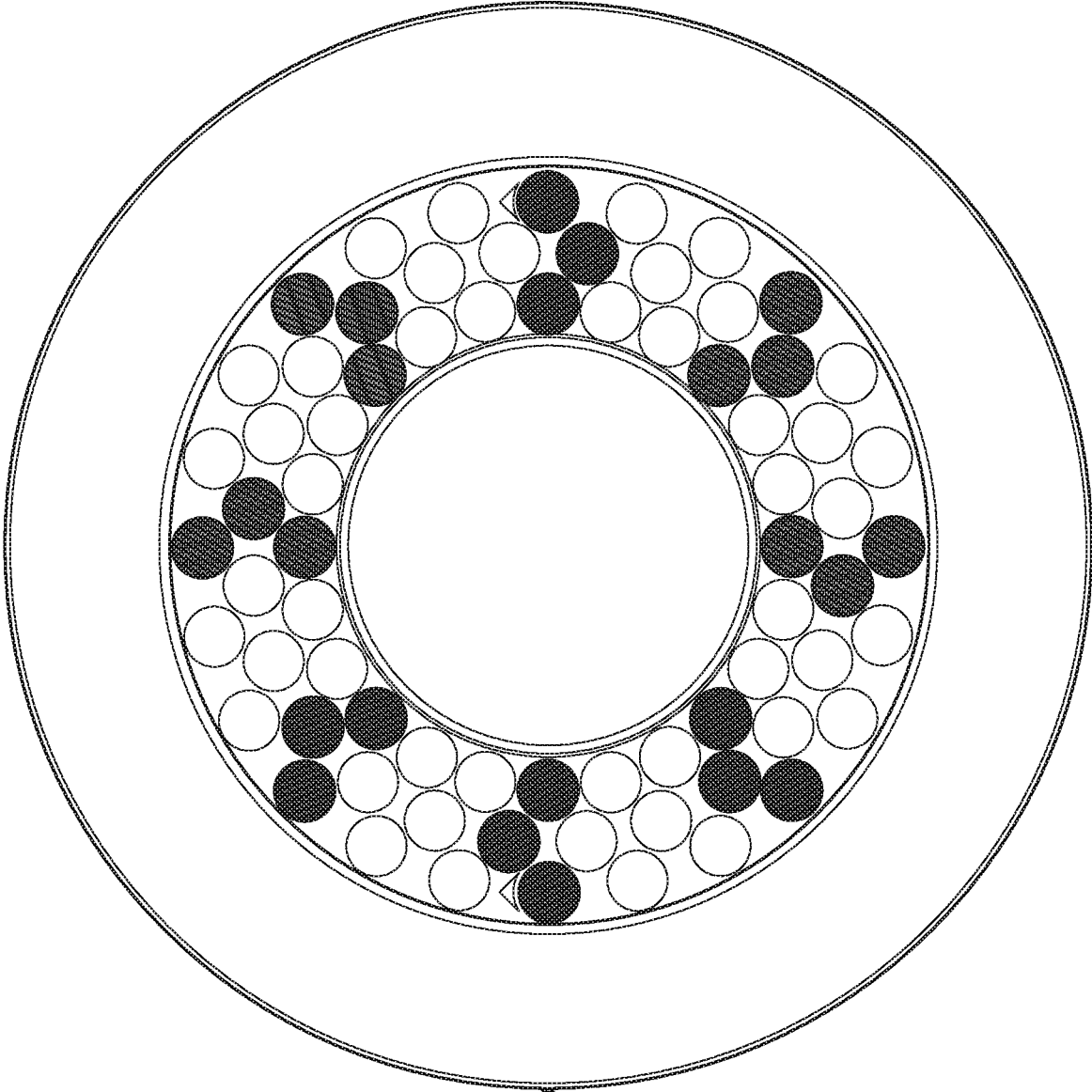

FIG. 2

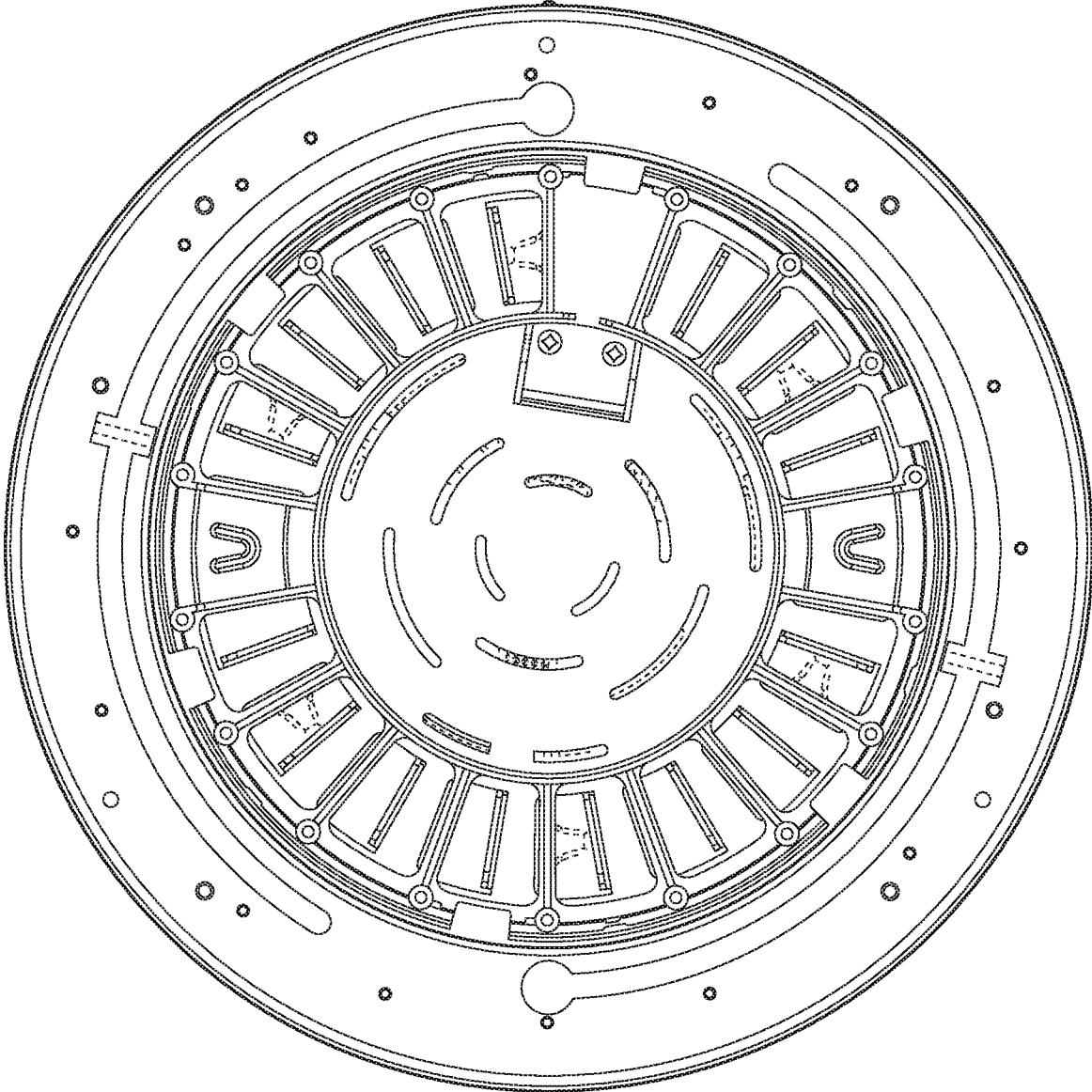

FIG. 3

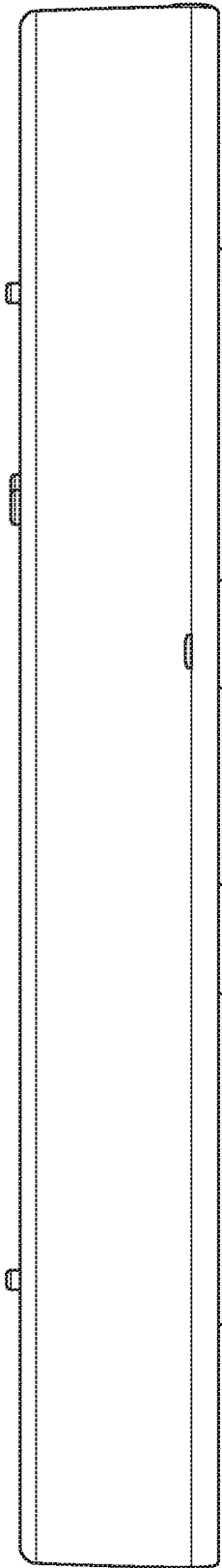

FIG. 4

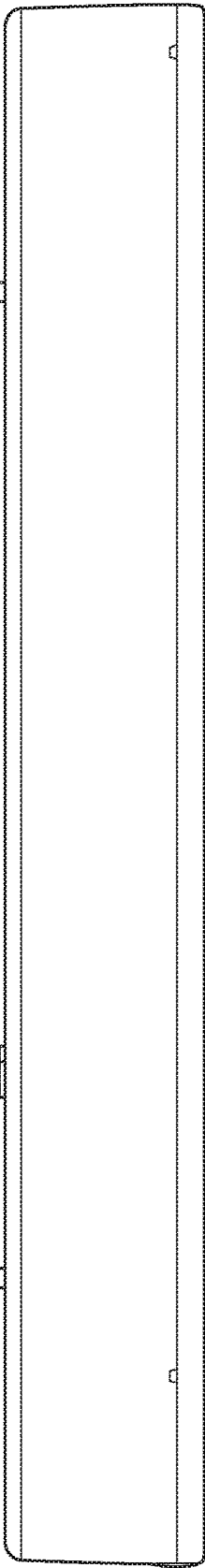

FIG. 5

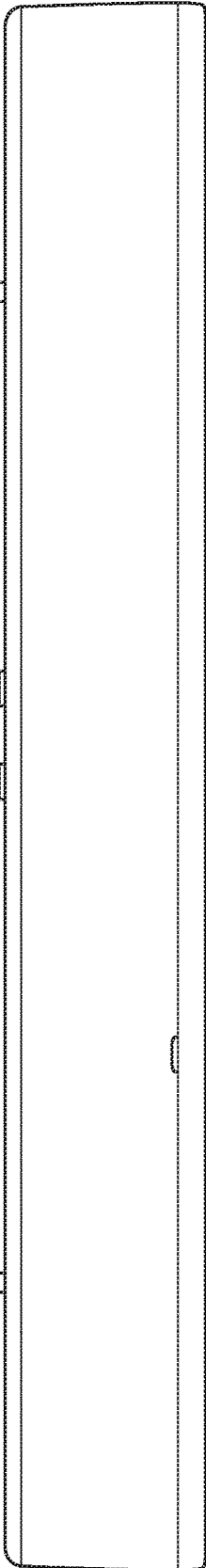

FIG. 6

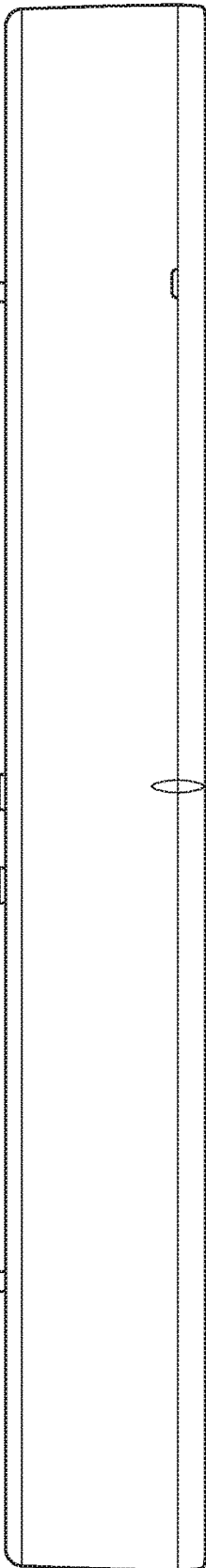

FIG. 7

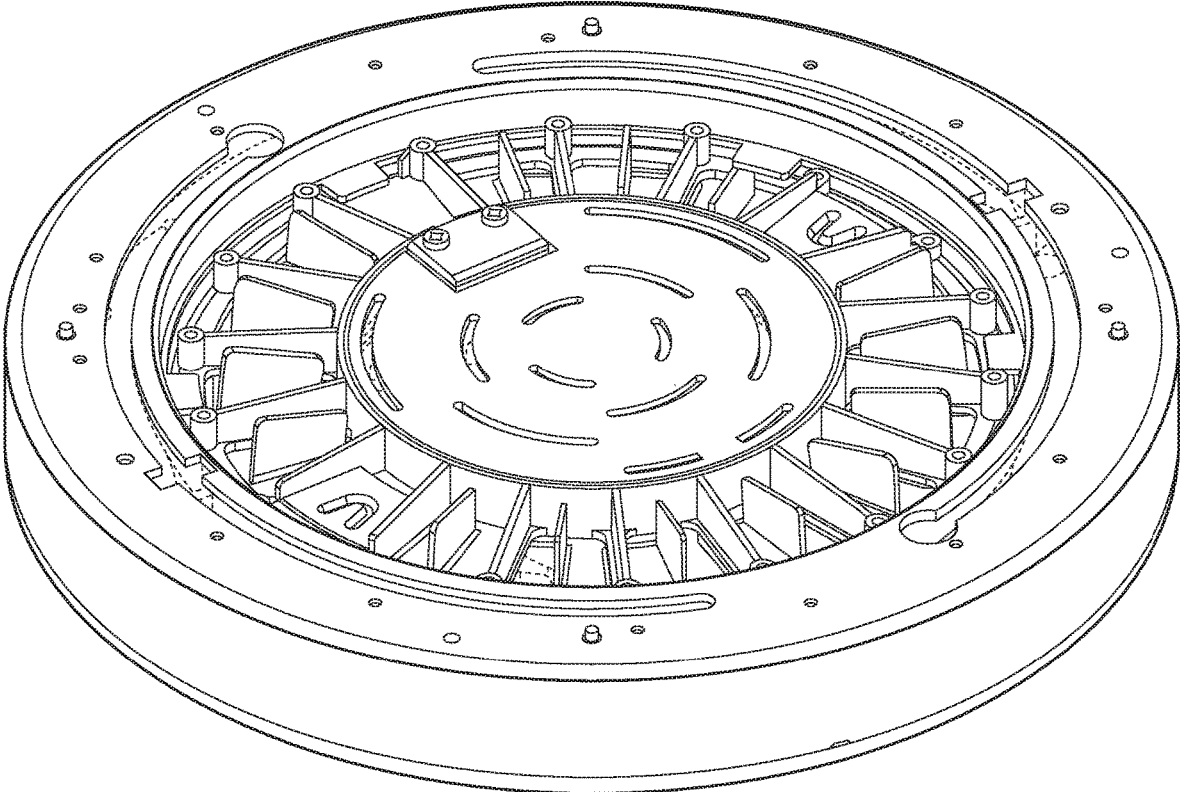

FIG. 8