



US00D985477S

(12) **United States Design Patent**  
**Guilford et al.**

(10) **Patent No.:** **US D985,477 S**

(45) **Date of Patent:** **\*\* May 9, 2023**

(54) **TIRE**

(71) Applicant: **The Goodyear Tire & Rubber Company**, Akron, OH (US)

(72) Inventors: **John Stephen Guilford**, Spencer, OH (US); **Daniel Thomas Murphy**, Mogadore, OH (US); **Jeffrey Leon Severt**, Cuyahoga Falls, OH (US)

(73) Assignee: **The Goodyear Tire & Rubber Company**, Akron, OH (US)

(\*\*) Term: **15 Years**

(21) Appl. No.: **29/772,028**

(22) Filed: **Feb. 26, 2021**

(51) **LOC (14) Cl.** ..... **12-15**

(52) **U.S. Cl.**  
USPC ..... **D12/600**

(58) **Field of Classification Search**  
USPC ..... D12/568-605, 900  
CPC ..... Y10T 152/10027; B60C 1/0016; B60C 11/0306; B60C 11/0302; B60C 3/06; B60C 9/17

See application file for complete search history.

(56) **References Cited**

**U.S. PATENT DOCUMENTS**

D364,135 S *	11/1995	Sulkowski	.....	D12/603
D394,034 S	5/1998	Feider et al.	.....	D12/147
D448,707 S	10/2001	Maziarka et al.	.....	D12/147
D461,162 S	8/2002	Young et al.	.....	D12/595
D527,339 S	8/2006	Lassan et al.	.....	D12/600
D531,115 S	10/2006	Ikeda	.....	D12/588
D541,737 S	5/2007	Cazin-Bourguignon et al.	.....	D12/600
D554,576 S	11/2007	Suzuki	.....	D12/588
D588,984 S	3/2009	Lee	.....	D12/588
D604,228 S *	11/2009	Le	.....	D12/596

(Continued)

**OTHER PUBLICATIONS**

U.S. Appl. No. 29/707,771, filed Oct. 1, 2019, Benvenuti.  
U.S. Appl. No. 29/709,600, filed Oct. 16, 2019, Pingnat.  
U.S. Appl. No. 29/748,979, filed Sep. 2, 2020, Pingnat.

*Primary Examiner* — John A Voytek

(74) *Attorney, Agent, or Firm* — June E. Rickey; Robert N. Lipsik

(57) **CLAIM**

The ornamental Design for a tire, as shown and described.

**DESCRIPTION**

FIG. 1 is a perspective view of a tire showing our new design, it being understood that the pattern repeats uniformly throughout the circumference of the tread; FIG. 2 is a front elevational view thereof; FIG. 3 is a right side elevational view thereof; the left side elevational view being identical thereto; FIG. 4 is an enlarged fragmentary front elevational view thereof taken along line 4-4 of FIG. 2; FIG. 5 is a perspective view of a second embodiment of a tire showing our new design, it being understood that the interior of the tire forms no part of the claim, that the pattern repeats uniformly throughout the circumference of the tread and that the opposite side view is identical thereto; and, FIG. 6 is a front elevational view of a second embodiment, it being understood that an enlarged fragmentary view thereof would be substantially identical to that shown in FIG. 4, with the exception of the inclusion of the sidewall in the claim.

In the drawings, the broken lines immediately adjacent to the outer edges of the tire shoulder represent boundaries of the claim, and the broken lines depict environmental subject matter only and form no part of the claimed design. The dashed broken lines indicating an enlargement portion of the design form no part of the claimed design.

**1 Claim, 6 Drawing Sheets**

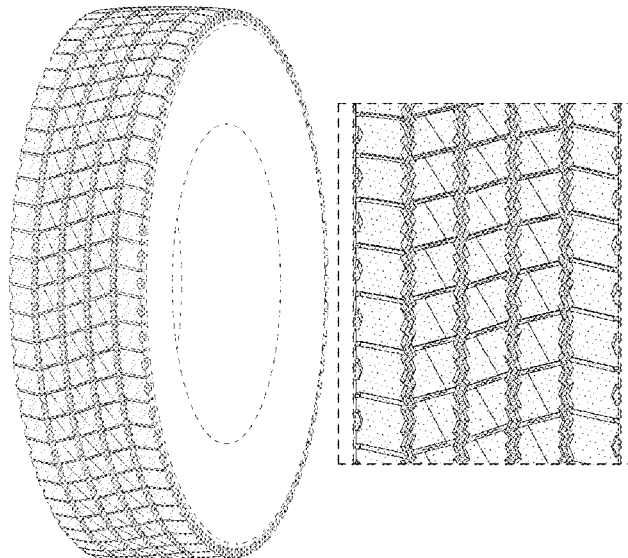

(56)

**References Cited**

## U.S. PATENT DOCUMENTS

D637,152 S	5/2011	Maus et al. ....	D12/602
D645,810 S *	9/2011	Le .....	D12/600
D648,264 S	11/2011	Le et al. ....	D12/588
D674,740 S	1/2013	Mathonet et al. ....	D12/588
D715,216 S	10/2014	Dixon et al. ....	D12/600
D715,217 S	10/2014	Dixon et al. ....	D12/600
D728,462 S	5/2015	Mathonet et al. ....	D12/588
D737,756 S	9/2015	Mathonet et al. ....	D12/601
D764,393 S	8/2016	Madar et al. ....	D12/588
D773,386 S	12/2016	Fujioka .....	D12/595
D820,778 S *	6/2018	Mansuy .....	D12/600
D823,782 S	7/2018	Bortolet et al. ....	D12/583
D837,137 S	1/2019	Becker et al. ....	D12/601
D842,231 S	3/2019	Becker et al. ....	D12/588
D851,025 S	6/2019	Wang et al. ....	D12/601
D855,011 S	7/2019	Le et al. ....	D12/588
D874,391 S	2/2020	Wang et al. ....	D12/588
D886,030 S *	6/2020	Le .....	D12/565
D900,719 S *	11/2020	Dixon .....	D12/583
D908,600 S	1/2021	Reygrobelle et al. ....	D12/588
D917,377 S *	4/2021	Reygrobelle .....	D12/600
D935,383 S *	11/2021	Sadananda .....	D12/584
D935,987 S *	11/2021	Benvenuti .....	D12/600
D935,988 S *	11/2021	Pingenat .....	D12/600

\* cited by examiner

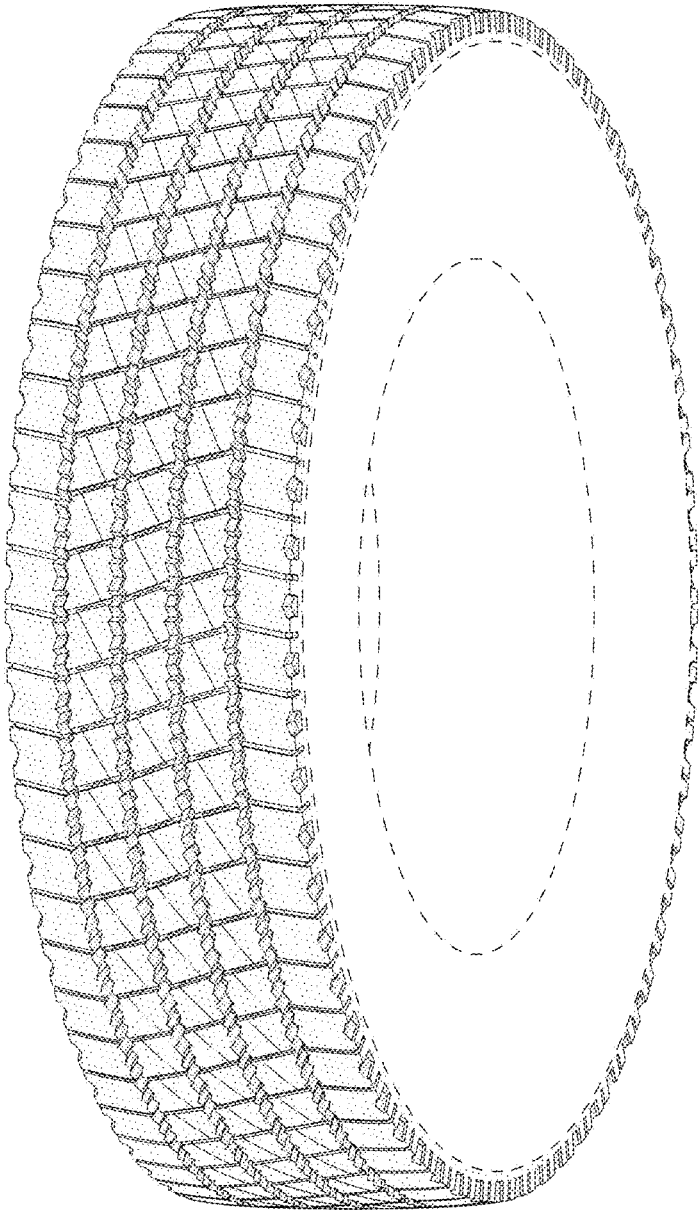

FIG - 1

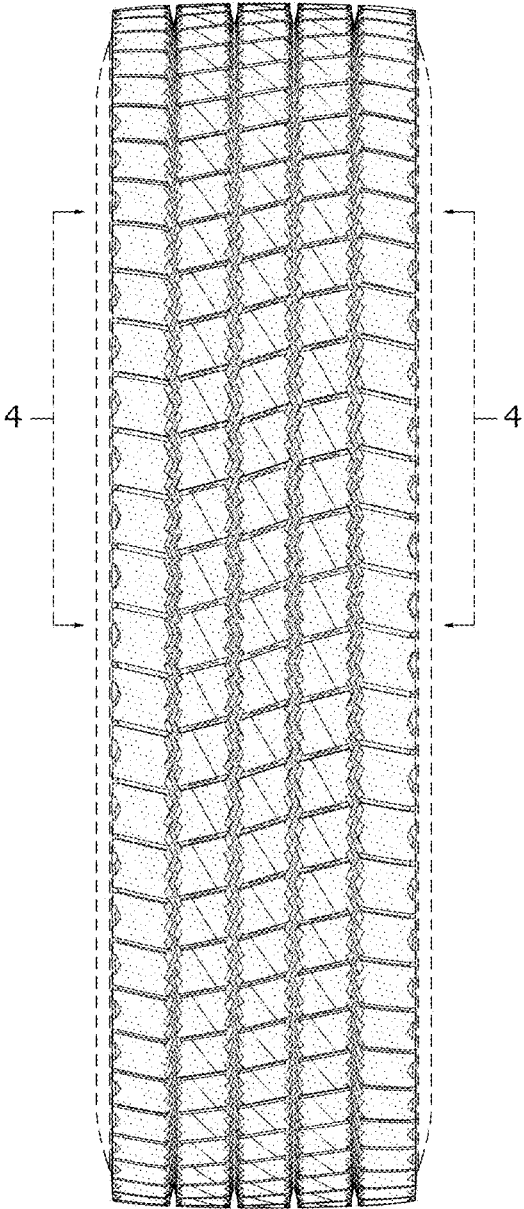

FIG - 2

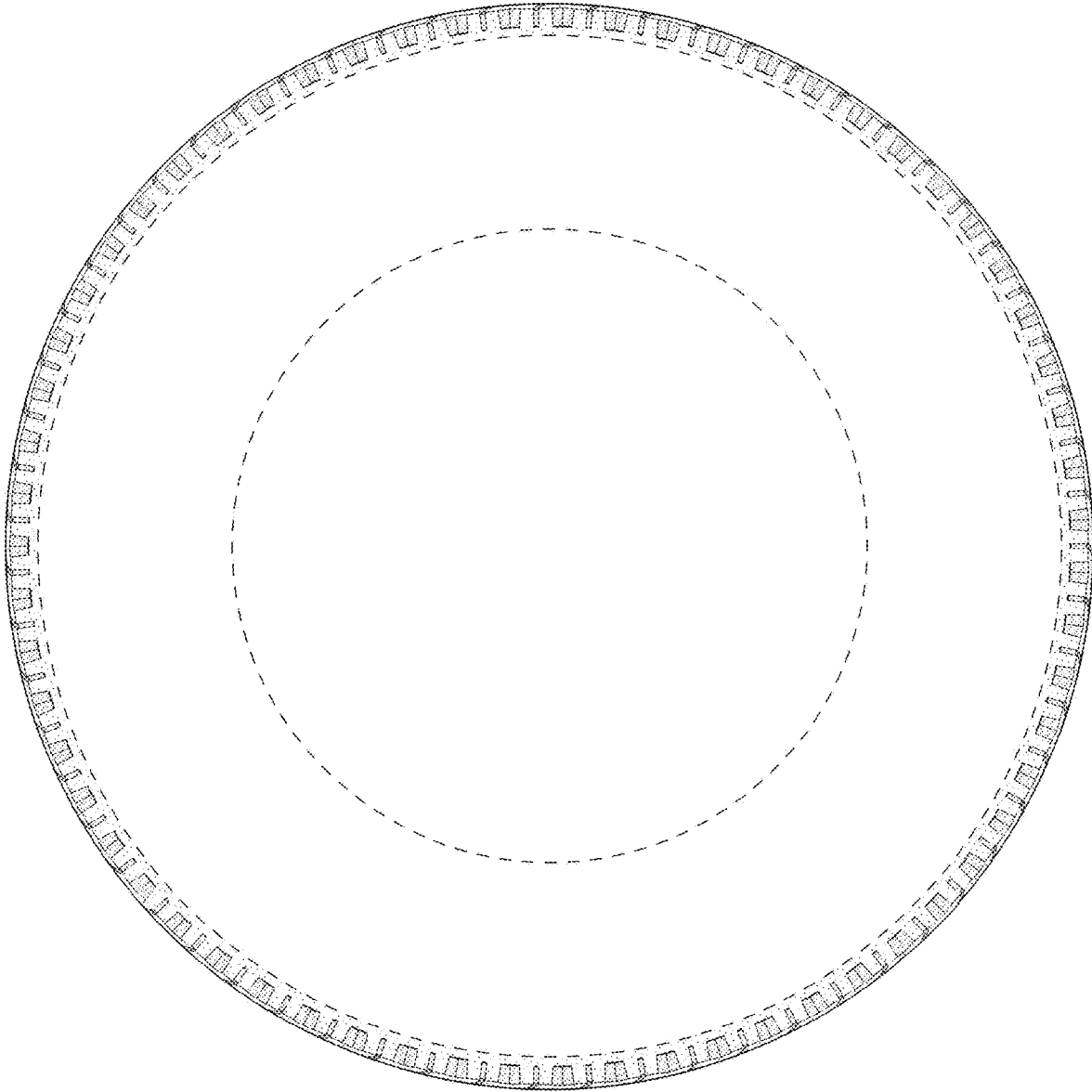

FIG - 3

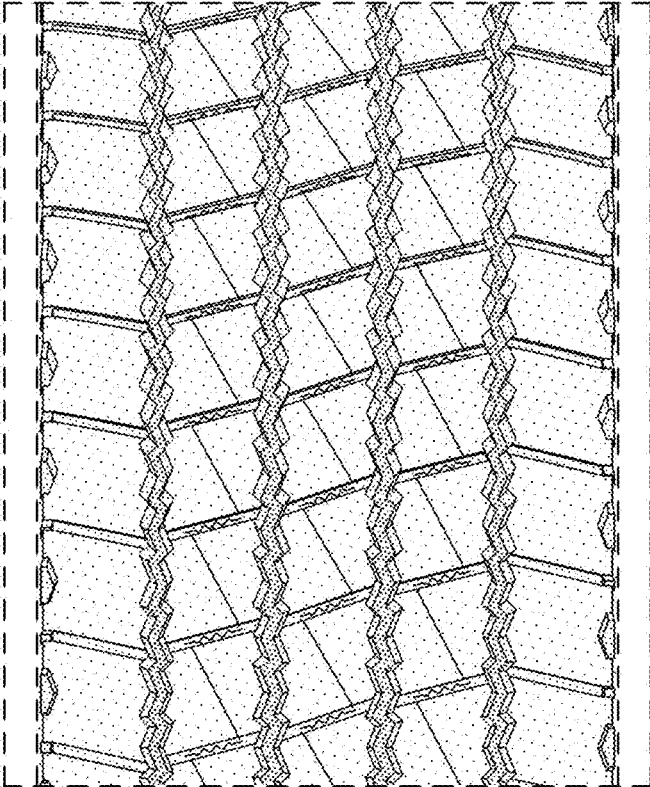

FIG - 4

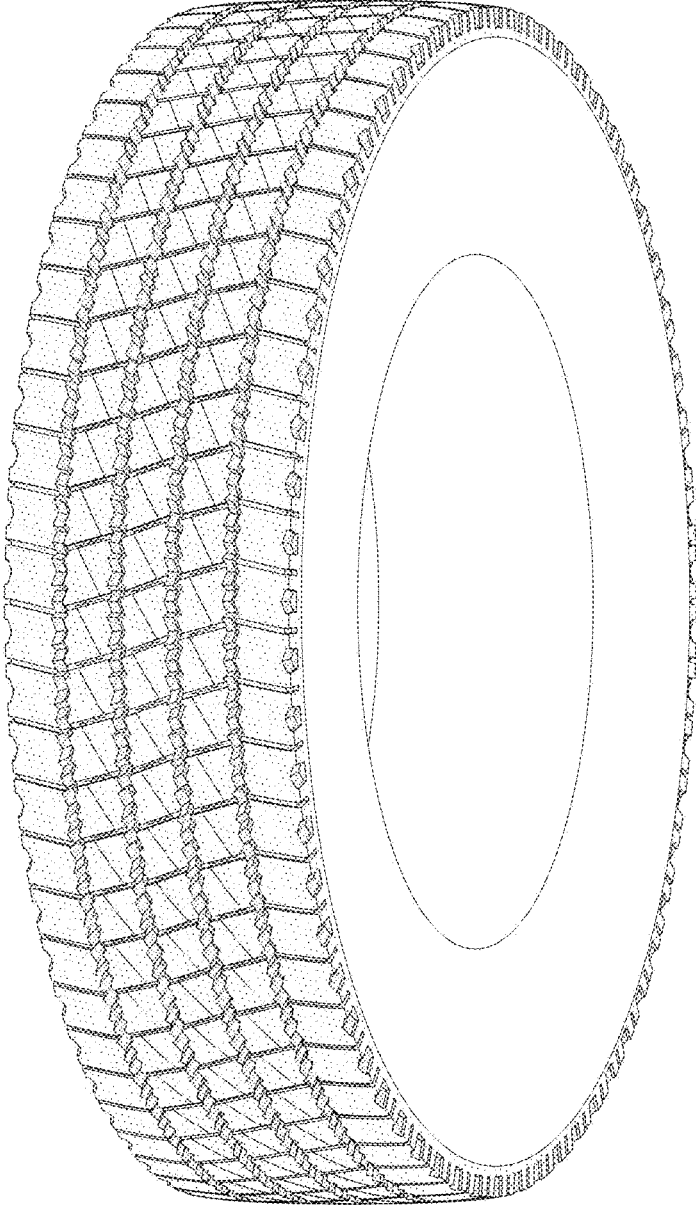

FIG - 5

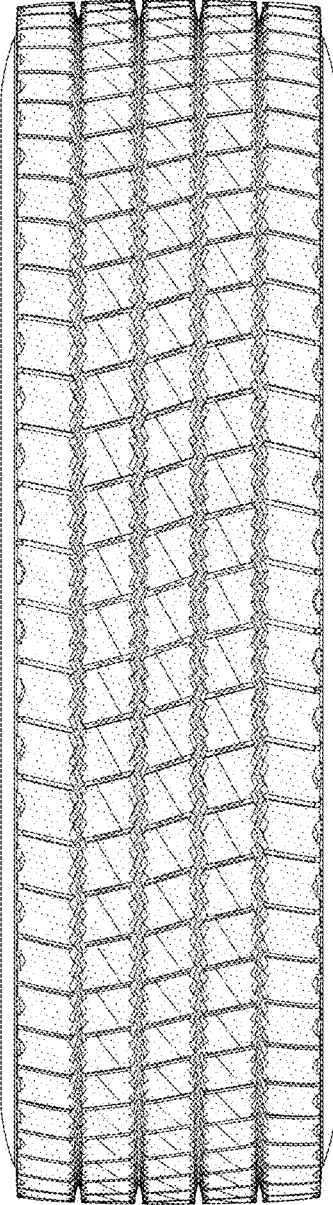

FIG - 6