



US00D746131S

(12) **United States Design Patent**  
**Astorga et al.**

(10) **Patent No.:** **US D746,131 S**

(45) **Date of Patent:** **\*\* Dec. 29, 2015**

(54) **CONTAINER**

(71) Applicant: **Peninsula Packaging Company, LLC,**  
Exeter, CA (US)

(72) Inventors: **Ricardo Astorga,** Whittier, CA (US);  
**Stephen Day,** Hollister, CA (US)

(73) Assignee: **PENINSULA PACKAGING**  
**COMPANY, LLC,** Exeter, CA (US)

(\*\*) Term: **14 Years**

(21) Appl. No.: **29/516,548**

(22) Filed: **Feb. 3, 2015**

(51) **LOC (10) Cl.** ..... **09-03**

(52) **U.S. Cl.**  
USPC ..... **D9/425**

(58) **Field of Classification Search**  
USPC ..... D9/414, 415, 416, 417, 418, 419, 420,  
D9/421, 422, 423, 424, 425, 426, 427, 428,  
D9/429, 431, 432, 433; D7/619.1, 629;  
229/401, 406, 407, 904, 906, 909;  
220/656, 657, 659, 662, 665, 669-675,  
220/912, 915.1, 4.21-4.25; 206/139, 214,  
206/217, 431, 528, 530, 538, 541, 553, 557  
CPC ..... A47G 21/14; A47J 47/14; B65D 1/22;  
B65D 1/34; B65D 1/36; B65D 1/40; B65D  
1/46; B65D 21/083; B65D 21/0234; B65D  
43/162; B65D 77/245; B65D 2543/00092;  
B65D 2543/00101; B65D 2543/00296; B65D  
3/28; B65D 5/4204; B65D 7/46; B65D 85/12;  
B65D 85/34; B21D 51/2646; A45C 11/20

See application file for complete search history.

(56) **References Cited**

U.S. PATENT DOCUMENTS

2,939,603 A	6/1960	Young	
D197,584 S *	2/1964	Nascher et al	206/499
D198,764 S *	7/1964	Bostrom	D9/425
3,351,227 A	11/1967	Collie	
3,351,270 A	11/1967	Hohnjec	
3,356,277 A	12/1967	Hohnjec	
3,396,867 A	8/1968	Garriga	
3,412,889 A	11/1968	Eicholtz et al.	
3,416,690 A	12/1968	Michael	
3,421,682 A	1/1969	Eisenbach	
3,655,110 A	4/1972	Eisenbach	
3,786,982 A	1/1974	Rakes et al.	
3,933,296 A	1/1976	Ruskin et al.	
D272,595 S	2/1984	Chase et al.	
4,494,650 A	1/1985	Cullen	
4,512,474 A	4/1985	Harding	
4,576,330 A	3/1986	Schepp	

(Continued)

*Primary Examiner* — Karen S Acker  
*Assistant Examiner* — Wendy Arminio  
(74) *Attorney, Agent, or Firm* — Loza & Loza, LLP; Heidi Eisenhut

(57) **CLAIM**  
The ornamental design for a container, as shown and described.

**DESCRIPTION**

FIG. 1 is a front top left side perspective view of a container of the present invention;  
FIG. 2 is a bottom rear right side perspective view of the container of FIG. 1;  
FIG. 3 is a front elevation view of the container of FIG. 1;  
FIG. 4 is a rear elevation view of the container of FIG. 1;  
FIG. 5 is a right side elevation view of the container of FIG. 1;  
FIG. 6 is a left side elevation view of the container of FIG. 1;  
FIG. 7 is a top plan view of the container of FIG. 1; and,  
FIG. 8 is a bottom plan view of the container of FIG. 1.

**1 Claim, 7 Drawing Sheets**

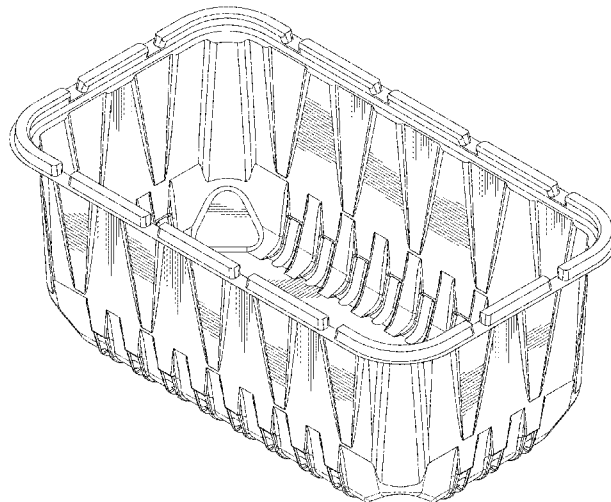

(56)

References Cited

U.S. PATENT DOCUMENTS

4,593,816 A	6/1986	Langenbeck		D514,389 S	2/2006	Luna et al.	
4,886,204 A	12/1989	Kalmanides		D531,802 S	11/2006	Zimmerman	
4,892,220 A	1/1990	Foos		7,204,388 B2	4/2007	Galland et al.	
5,012,928 A	5/1991	Proffitt et al.		D544,755 S	6/2007	Diesman	
D318,420 S	7/1991	Amelse		7,243,813 B2	7/2007	Krueger	
5,031,774 A	7/1991	Morris et al.		7,246,714 B2	7/2007	Garg et al.	
5,046,659 A	9/1991	Warburton		7,255,231 B2	8/2007	Andrews et al.	
5,071,026 A	12/1991	Apps		D566,483 S	4/2008	Tucker et al.	
5,092,479 A	3/1992	Wells		D569,243 S	5/2008	Kidd et al.	
5,156,267 A	10/1992	Yates, Jr. et al.		D579,326 S	10/2008	Chen	
5,169,014 A	12/1992	Hexamer		7,441,672 B2	10/2008	Cadiente et al.	
D341,461 S *	11/1993	Davidson	D3/312	7,472,799 B2	1/2009	Cadiente et al.	
D343,576 S	1/1994	Krupa		D591,148 S	4/2009	Parikh et al.	
5,377,860 A	1/1995	Littlejohn et al.		7,597,206 B2	10/2009	Atkins et al.	
D361,035 S	8/1995	Krupa		D604,604 S	11/2009	Strange	
D361,036 S	8/1995	Krupa		D606,811 S	12/2009	Furlong	
5,456,379 A	10/1995	Krupa et al.		D607,282 S	1/2010	Furlong	
D363,879 S	11/1995	Krupa et al.		D621,222 S	8/2010	Heiberg et al.	
5,497,894 A	3/1996	Krupa et al.		7,784,615 B2	8/2010	Stahl	
5,515,993 A	5/1996	McManus		7,819,279 B2	10/2010	Galland et al.	
5,584,408 A	12/1996	Orkisz		D628,472 S *	12/2010	Strange	D9/425
D378,192 S	2/1997	Krupa et al.		7,866,502 B2	1/2011	Maxwell	
D382,112 S	8/1997	Egan		D663,525 S *	7/2012	Rhoades	D3/314
D382,795 S	8/1997	Abayhan et al.		D668,537 S *	10/2012	Sanfilippo	D9/423
5,653,345 A	8/1997	Knoss et al.		D678,050 S	3/2013	Birchmeier et al.	
5,711,978 A	1/1998	Breen et al.		D688,941 S	9/2013	Sifuentes et al.	
5,730,311 A *	3/1998	Curtis	B65D 21/0222 206/508	D696,938 S	1/2014	BeVier et al.	
				8,895,092 B1 *	11/2014	Field	B65B 25/06 206/497
5,758,791 A	6/1998	Mangla		D720,990 S	1/2015	Jacobs et al.	
5,833,116 A	11/1998	Guillin		D723,339 S	3/2015	Maxwell et al.	
5,860,549 A	1/1999	Allers et al.		D723,340 S	3/2015	Maxwell et al.	
D409,485 S	5/1999	Christy, Jr.		2003/0052133 A1	3/2003	Hayes et al.	
5,979,687 A	11/1999	Hayes et al.		2003/0121917 A1 *	7/2003	Fore	B65D 1/26 220/4.22
5,992,628 A	11/1999	Vermilion et al.		2003/0152670 A1	8/2003	Shih	
D419,375 S *	1/2000	Mangla	D7/387	2003/0192888 A1	10/2003	Chang	
6,079,554 A	6/2000	Hammett et al.		2003/0198714 A1	10/2003	Cadiente et al.	
6,085,930 A	7/2000	Curtis		2005/0040068 A1	2/2005	Palder	
D438,100 S	2/2001	Cekota		2005/0167317 A1	8/2005	Barrett et al.	
D446,719 S *	8/2001	Garraway	D9/425	2005/0247709 A1	11/2005	Atkins et al.	
D451,278 S	12/2001	Cooper		2006/0289550 A1	12/2006	Guardigli	
D461,123 S *	8/2002	Hayes	D9/425	2007/0045631 A1	3/2007	Endo et al.	
D467,496 S	12/2002	Hayes et al.		2007/0095848 A1	5/2007	Galland et al.	
6,508,395 B2	1/2003	McLeod		2008/0000800 A1	1/2008	LaMarche et al.	
6,588,612 B1	7/2003	Dorn et al.		2008/0023472 A1	1/2008	Brandt	
D478,282 S	8/2003	Hayes et al.		2008/0135556 A1	6/2008	Bontrager et al.	
6,644,494 B2	11/2003	Hayes et al.		2009/0065514 A1	3/2009	Vovan	
6,666,348 B2	12/2003	Fore et al.		2009/0134179 A1	5/2009	Kidd et al.	
D490,278 S	5/2004	Welsh		2009/0134180 A1	5/2009	Kidd et al.	
D493,672 S	8/2004	Jalet et al.		2009/0223966 A1	9/2009	Kidd et al.	
6,845,878 B2	1/2005	Hayes et al.		2011/0189355 A1 *	8/2011	Field	B65D 81/2069 426/129
D506,147 S	6/2005	Hall					
D509,106 S	9/2005	de Groot et al.					

\* cited by examiner

FIG. 1

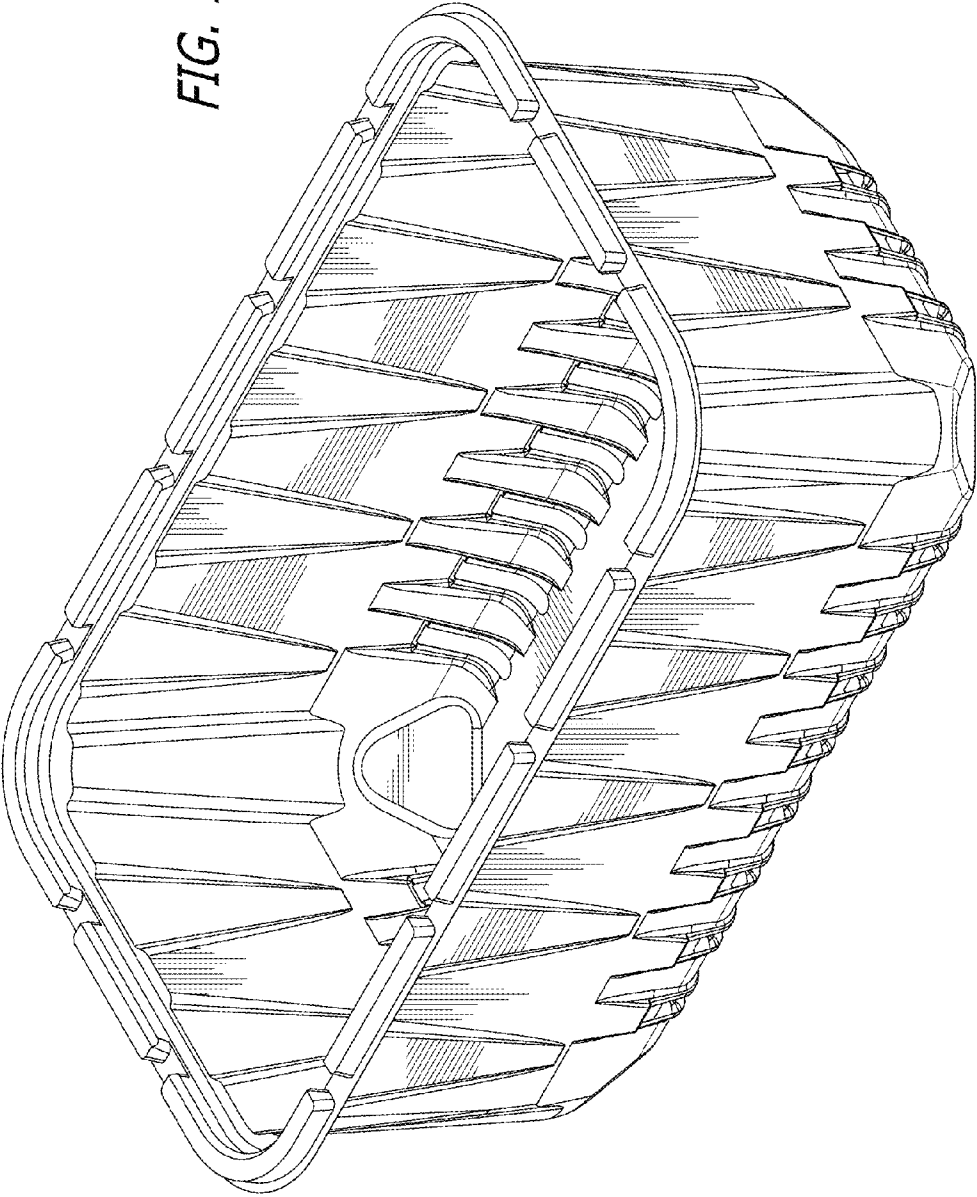
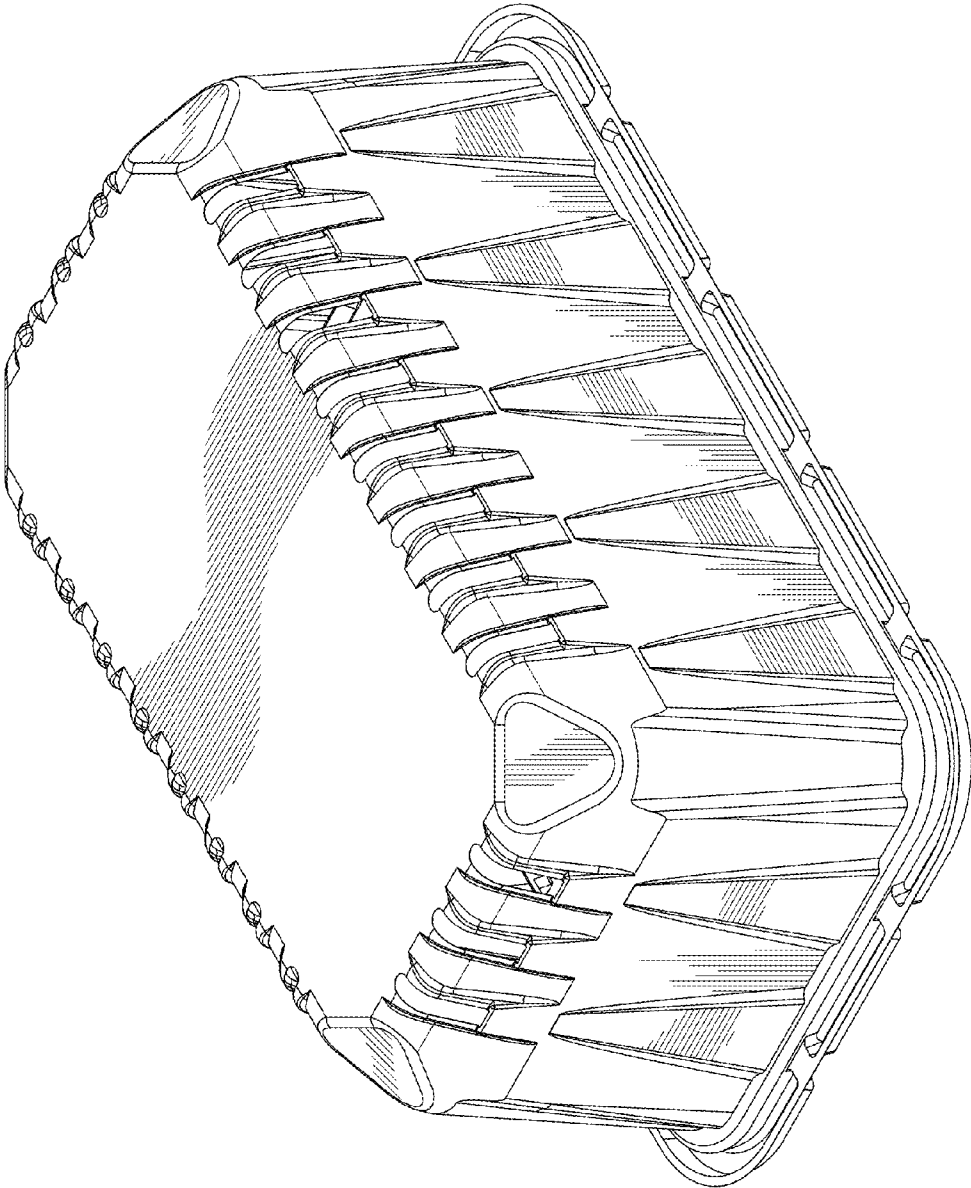

FIG. 2



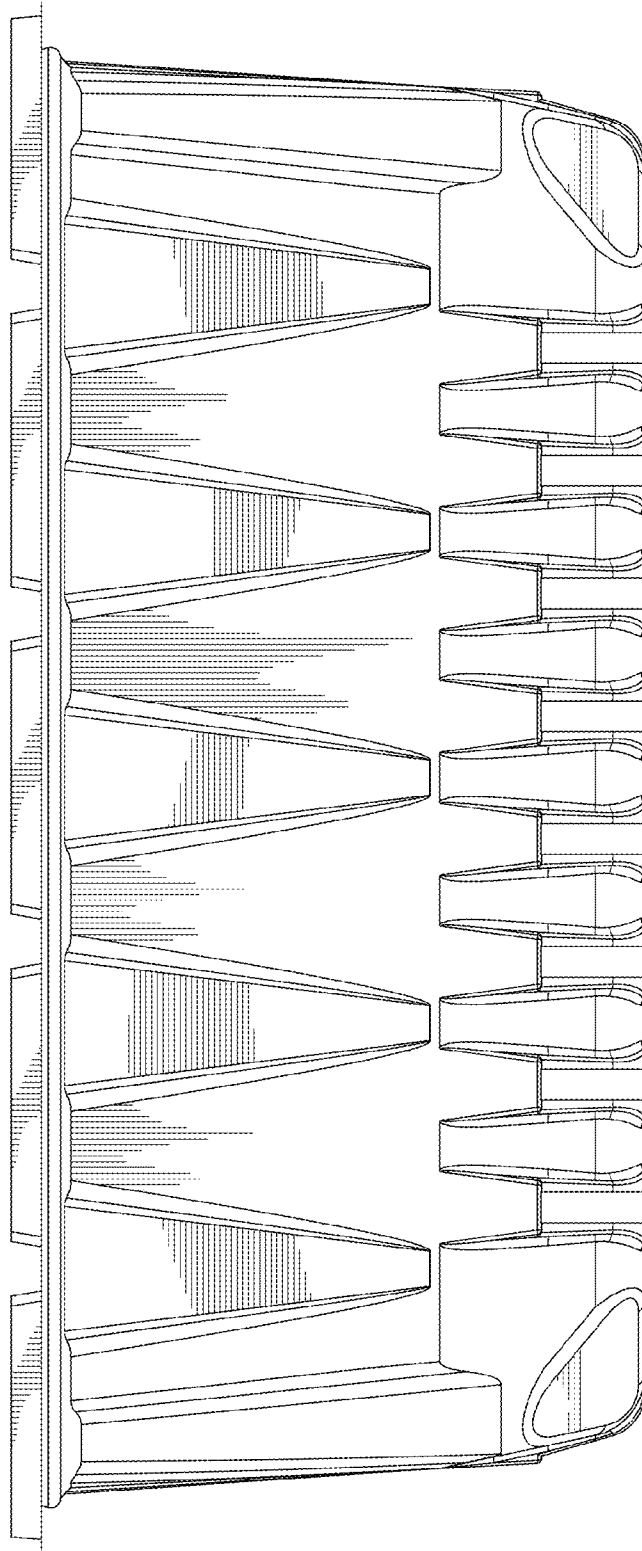

FIG. 3

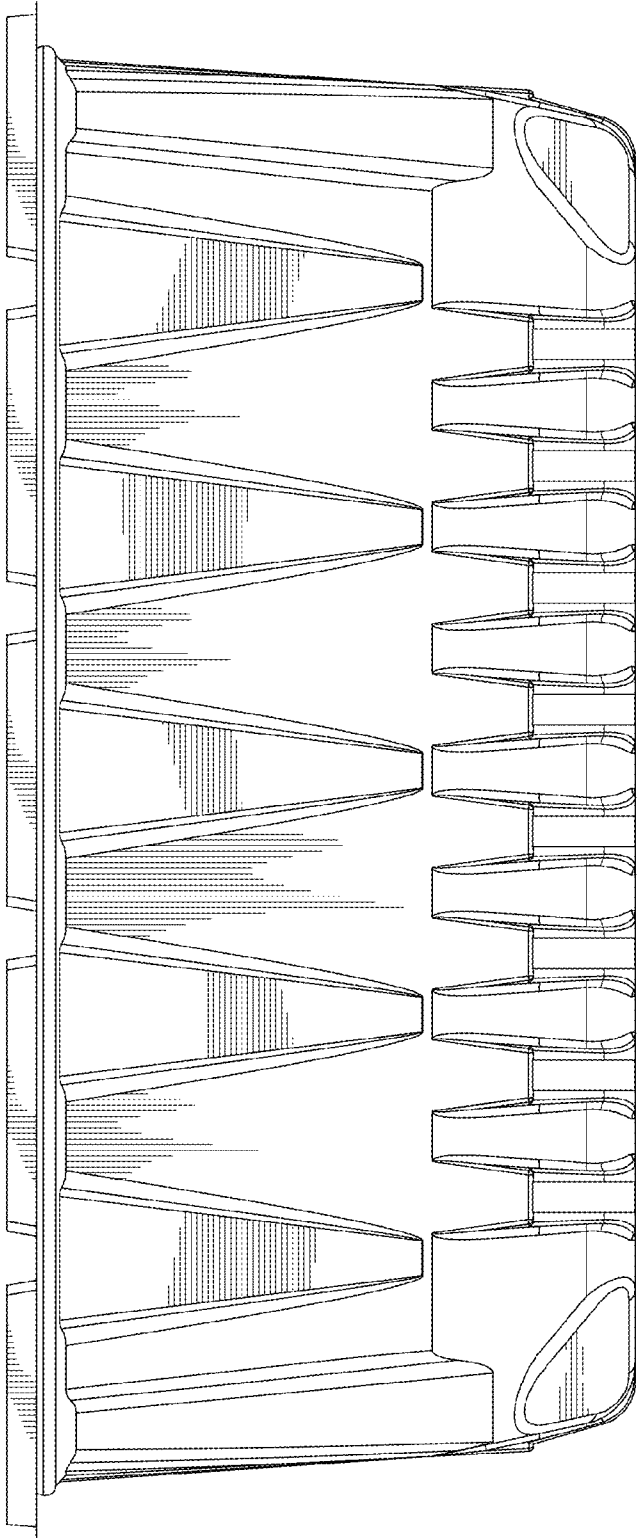

FIG. 4

FIG. 5

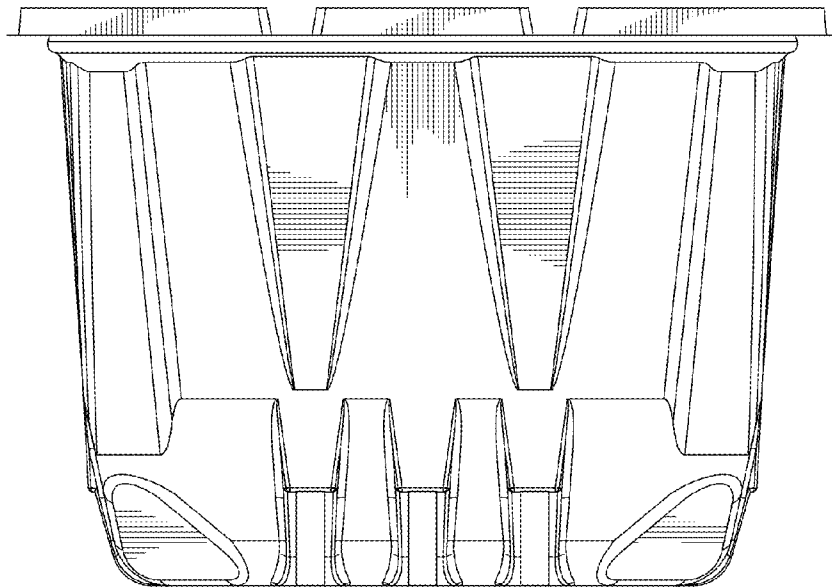
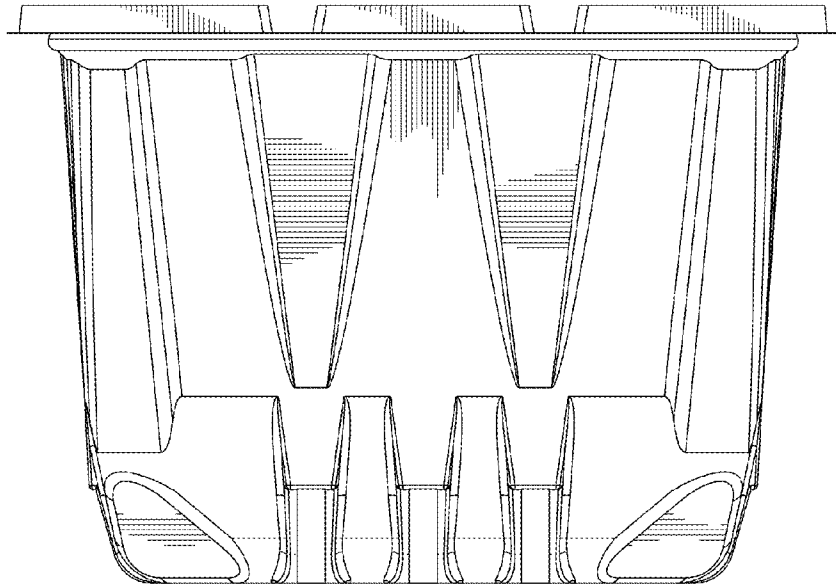

FIG. 6

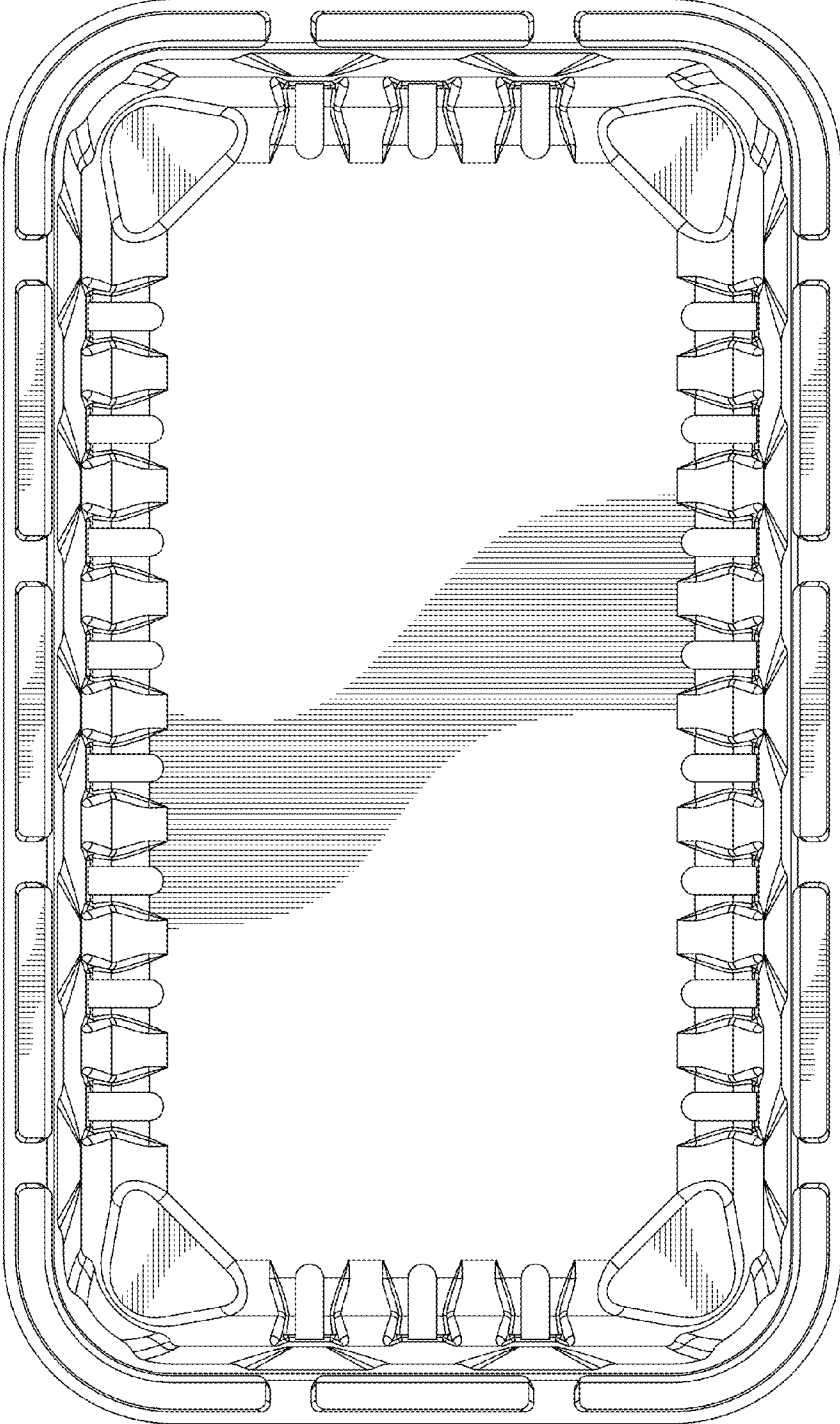

FIG. 7



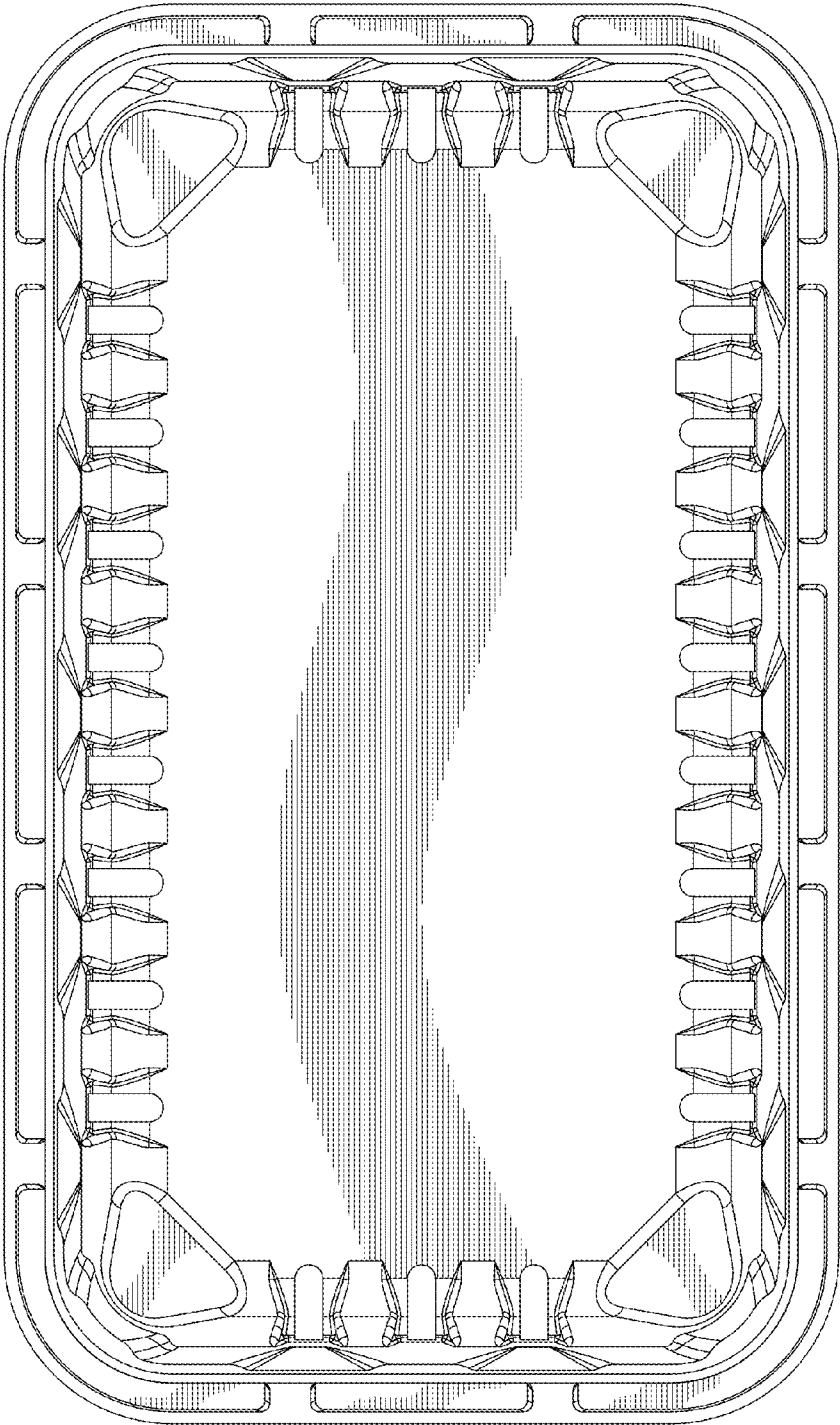

FIG. 8