



(51) International Patent Classification:

H01M 2/16 (2006.01)

(21) International Application Number:

PCT/US2018/058347

(22) International Filing Date:

31 October 2018 (31.10.2018)

(25) Filing Language:

English

(26) Publication Language:

English

(30) Priority Data:

62/579,443 31 October 2017 (31.10.2017) US

(71) Applicant: **GEORGIA TECH RESEARCH CORPORATION** [US/US]; 505 10th Street, NW, Atlanta, Georgia 30332 (US).

(72) Inventors: **LOSEGO, Mark D.**; 339 Deering Rd NW, Atlanta, Georgia 30309 (US). **LIVELY, Ryan P.**; 1080 Peachtree St NE Unit 1212, Atlanta, Georgia 30309 (US). **MCGUINNESS, Emily K.**; 1940 Northside Drive NW, Atlanta, Georgia 30318 (US). **ZHANG, Fengyi**; 251 10th ST NW, Apt 706, Atlanta, Georgia 30318 (US).

(74) Agent: **NEAR, Rachel D.** et al.; Meunier Carlin & Curfman LLC, 999 Peachtree Street NE, Suite 1300, Atlanta, Georgia 30309 (US).

(81) Designated States (unless otherwise indicated, for every kind of national protection available): AE, AG, AL, AM, AO, AT, AU, AZ, BA, BB, BG, BH, BN, BR, BW, BY, BZ, CA, CH, CL, CN, CO, CR, CU, CZ, DE, DJ, DK, DM, DO,

DZ, EC, EE, EG, ES, FI, GB, GD, GE, GH, GM, GT, HN, HR, HU, ID, IL, IN, IR, IS, JO, JP, KE, KG, KH, KN, KP, KR, KW, KZ, LA, LC, LK, LR, LS, LU, LY, MA, MD, ME, MG, MK, MN, MW, MX, MY, MZ, NA, NG, NI, NO, NZ, OM, PA, PE, PG, PH, PL, PT, QA, RO, RS, RU, RW, SA, SC, SD, SE, SG, SK, SL, SM, ST, SV, SY, TH, TJ, TM, TN, TR, TT, TZ, UA, UG, US, UZ, VC, VN, ZA, ZM, ZW.

(84) Designated States (unless otherwise indicated, for every kind of regional protection available): ARIPO (BW, GH, GM, KE, LR, LS, MW, MZ, NA, RW, SD, SL, ST, SZ, TZ, UG, ZM, ZW), Eurasian (AM, AZ, BY, KG, KZ, RU, TJ, TM), European (AL, AT, BE, BG, CH, CY, CZ, DE, DK, EE, ES, FI, FR, GB, GR, HR, HU, IE, IS, IT, LT, LU, LV, MC, MK, MT, NL, NO, PL, PT, RO, RS, SE, SI, SK, SM, TR), OAPI (BF, BJ, CF, CG, CI, CM, GA, GN, GQ, GW, KM, ML, MR, NE, SN, TD, TG).

Published:

— with international search report (Art. 21(3))

(54) Title: HYBRID MEMBRANES AND METHODS OF MAKING AND USE THEREOF

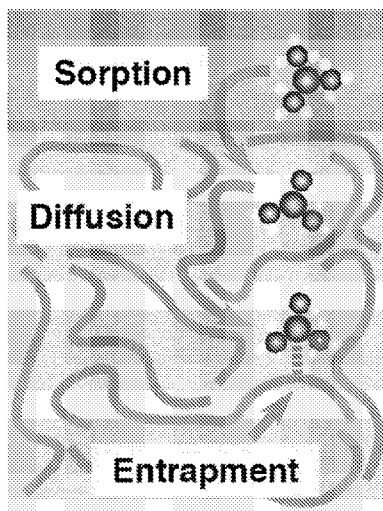

Figure 4

(57) Abstract: Disclosed herein are hybrid membranes comprising: a microporous polymer, the microporous polymer comprising a continuous polymer phase permeated by a continuous pore phase; and an atomic scale inorganic material dispersed throughout the microporous polymer within the continuous pore phase. Methods of making and use of the hybrid membranes are also disclosed.



HYBRID MEMBRANES AND METHODS OF MAKING AND USE THEREOF

CROSS-REFERENCE TO RELATED APPLICATIONS

This application claims the benefit of U.S. Provisional Application No. 62/579,443,
5 filed October 31, 2017, which is hereby incorporated herein by reference in its entirety.

STATEMENT OF GOVERNMENT SUPPORT

This invention was made with government support under Grant No. CBET 1653153
and Grant No. ECCS-1542174 awarded by The National Science Foundation. The
government has certain rights in this invention.

10

BACKGROUND

Advances in chemical separations are sorely needed, as these processes have an
outsized energy and carbon footprint. In fact, 10-15% of worldwide energy consumption
has been attributed to these processes. Membrane-based organic solvent separations
promise a low-energy alternative to traditional thermal separations. Membranes thus have
15 the potential to revolutionize energy and carbon savings in separations. However, because
many of these separations must occur in challenging organic solvent environments, scalable
and robust membrane materials that operate reliably in chemically aggressive environments
are needed (Lively et al. *Nature Materials*, 2017, 16, 276-279). While inorganic membranes
can withstand demanding conditions, they are costly and difficult to scale. Polymeric
20 membranes can be easily manufactured into form factors consistent with large-scale
separations (e.g., hollow fibers), but perform poorly in aggressive solvents. Membrane
scientists and engineers have addressed this problem by either creating cross-linked
polymer networks (Jimenez-Solomon et al. *Nature Materials*, 2016, 15, 760-767) or by
carbonizing precursor membranes (Zhang et al. *Advanced Materials*, 2017, 29(33),
25 1701631; Koh et al. *Science*, 2016, 353(6301), 804-807). While somewhat effective, these
methods also increase manufacturing complexity due to the need to process excess chemical
waste or to operate high temperature pyrolysis equipment. Therefore, a need still exists for
membranes that can be used in challenging separations. The compositions and methods
described herein address these and other needs.

SUMMARY

In accordance with the purposes of the disclosed compositions and methods, as embodied and broadly described herein, the disclosed subject matter relates to hybrid membranes and methods of making and use thereof.

5 Additional advantages of the disclosed compositions and methods will be set forth in part in the description which follows, and in part will be obvious from the description. The advantages of the disclosed compositions and methods will be realized and attained by means of the elements and combinations particularly pointed out in the appended claims. It is to be understood that both the foregoing general description and the following detailed
10 description are exemplary and explanatory only and are not restrictive of the disclosed compositions, as claimed.

The details of one or more embodiments of the invention are set forth in the accompanying drawings and the description below. Other features, objects, and advantages of the invention will be apparent from the description and drawings, and from the claims.

15 BRIEF DESCRIPTION OF THE FIGURES

The accompanying figures, which are incorporated in and constitute a part of this specification, illustrate several aspects of the disclosure, and together with the description, serve to explain the principles of the disclosure.

20 Figure 1 is a plot of chamber pressure (as measured by a Baratron Capacitance Manometer) as a function of time in an exemplary VPI process.

Figure 2 is an illustration of conducting VPI in a hollow fiber membrane module.

Figure 3 is a schematic diagram of a vapor phase infiltration (VPI) reactor.

Precursors were dosed into a static vapor environment. The chamber was pumped and purged with nitrogen between the precursor and co-reactant doses.

25 Figure 4 is a schematic depiction of VPI process: precursor sorption, diffusion, and entrapment (coordination or chemical reaction).

Figure 5 is a schematic depiction of metal-organic precursors sorbing into the PIM-1 microporosity and becoming trapped.

30 Figure 6 is a schematic depiction of water vapor sorbing into the structure and reacting with the metal-organic to form an interpenetrating metal oxide network. Infiltration of precursors and co-reactants are often cycled twice to increase the inorganic loading.

Figure 7 is an EDX elemental map of a defect-free PIM-1 membrane of 70 μm thickness after 10 cycles of infiltration of ZnO_x with a hold time of 2 hours at 90 $^\circ\text{C}$.

Figure 8 is the zinc loading profile across the membrane shown in Figure 7.

Figure 9 is a plot of the infiltration depth of aluminum into thick PIM-1 membranes as a function of hold time.

Figure 10 is a SEM image with an EDX map of a section of the PIM-1 membrane after infiltration with trimethylaluminum and water (2 cycles). White pixels in EDX map show aluminum distribution throughout the hybrid membrane.

Figure 11 is a higher magnification SEM image with an EDX map of the section of the PIM-1 membrane after infiltration with trimethylaluminum and water (2 cycles) indicated by the box in Figure 10. White pixels in EDX map show aluminum distribution throughout the hybrid membrane.

Figure 12 is a TEM image of the section of the PIM-1 membrane after infiltration with trimethylaluminum and water (2 cycles) indicated by the box in Figure 11.

Figure 13 is the XRD patterns of pristine PIM-1, ZnO_x/PIM-1, TiO_x/PIM-1, and AlO_x/PIM-1.

Figure 14 is the C^{1s}, N^{1s}, and O^{1s} XPS spectra for pristine PIM-1 and PIM-1 infiltrated with AlO_x, ZnO_x, and TiO_x. * Broad hydroxyl peaks are induced by absorbed water.

Figure 15 is the Al^{2p} XPS spectra of Al₂O₃ and AlO_x/PIM-1.

Figure 16 is the Zn^{2p} XPS spectra of ZnO and ZnO_x/PIM-1.

Figure 17 is the Ti^{2p} XPS spectra of TiO₂ and TiO_x/PIM-1.

Figure 18 is the O^{1s} XPS spectra of Al₂O₃, ZnO, TiO₂ and pristine PIM-1.

Figure 19 is the solid-state ¹H NMR spectra of pristine PIM-1, ZnO_x/PIM-1, TiO_x/PIM-1, and AlO_x/PIM-1. All these samples exhibit identical ¹³C and ¹H signals, which indicates the identical chemical environments of carbon and hydrogen atoms. PIM-1 powders used for NMR were obtained via grinding PIM-1 hollow fiber membranes. All PIM-1/metal oxide hybrids are infiltrated twice with 5-hour hold time. In AlO_x/PIM-1, 92.6% of infiltrated aluminum atoms take octahedral coordination, which is hypothetically favored for the AlO_x nanostrand growth within tortuous micropores of the PIM-1 skeleton.

Figure 20 is the solid-state ¹³C NMR spectra of pristine PIM-1, ZnO_x/PIM-1, TiO_x/PIM-1, and AlO_x/PIM-1.

Figure 21 is the logarithmic FTIR spectra for pristine PIM-1 and PIM-1 infiltrated with AlO_x, ZnO_x, and TiO_x. *Broad hydroxyl peaks are induced by absorbed water.

Figure 22 is the proposed mechanism for metal oxide network formation via TMA VPI of PIM-1.

Figure 23 is a two-dimensional view of the solid-state ^{27}Al NMR spectrum of $\text{AlO}_x/\text{PIM-1}$.

5 Figure 24 is a plot of the AlO_x loading for a control and long-duration purging experiment. PIM-1 hollow fiber membranes were methanol pre-treated, dried, and VPI treated with 1 cycle of TMA/ H_2O with 5 hour exposure times at 90°C . For one membrane (“no additional purging”), the typical procedure of N_2 purging five minutes and pumping five minutes was followed prior to the final 5-hour water vapor exposure. For the other
10 membrane, an additional 25-hour purge step was placed between TMA and water vapor exposures, to determine whether TMA would diffuse out of the membrane during this time. Both methods resulted in similar weight percent loadings of AlO_x in PIM-1. This result suggests that the binding state between TMA and PIM-1 is semi-permanent (irreversible) and does not significantly desorb during the VPI process.

15 Figure 25 is a photograph of alumina hollow fiber membranes obtained by annealing $\text{AlO}_x/\text{PIM-1}$ hybrid hollow fiber membranes in air (900°C). Heat treating in air combusts the polymer and leaves just an AlO_x nanoporous structure. The intact alumina hollow fiber membrane indicates the thorough infiltration of metal oxide into PIM-1 hollow fiber membranes. The porosity exhibited by the alumina hollow fiber membrane is consistent
20 with our hypothesis that metal oxide nanostrands reside in the micropores of PIM-1, which is a porous template. The reduced porosity is likely due to sintering of the structure during heating.

Figure 26 is a SEM image of the portion of the alumina hollow fiber membrane after burn out indicated by the box in Figure 25.

25 Figure 27 is a higher magnification SEM image of the portion of the alumina hollow fiber membrane after burn out indicated by the box in Figure 26.

Figure 28 is the cryogenic nitrogen physisorption of the alumina hollow fiber membranes compared with that of pristine PIM-1 hollow fiber membranes and $\text{AlO}_x/\text{PIM-1}$ hollow fiber membranes.

30 Figure 29 is the pore size distribution of alumina hollow fiber membranes compared that of pristine PIM-1 hollow fiber membranes and $\text{AlO}_x/\text{PIM-1}$ hollow fiber membranes.

Figure 30 is the metal oxide loading (bar graph) and BET surface area (dot plots, errors are smaller than markers) of PIM-1/metal oxide hybrids as a function of metal-organic chemistry.

Figure 31 is the metal oxide loading (bar graphs) and BET surface area (dot plots, errors are smaller than markers) of AlO_x /PIM-1 hybrid membranes as a function infiltration time and number of infiltration cycles.

Figure 32 is the nitrogen isotherms at 77 K for neat and infiltrated PIM-1 membranes showing the influence of VPI chemistry and processing conditions on microporosity of the membranes.

Figure 33 is the pore size distribution calculated using N_2 DFT model.

Figure 34 is a plot that shows that methanol pretreatment effectively increased metal oxide loading. PIM-1 hollow fiber membranes with and without methanol pretreatment were VPI treated with 2 cycles of TMA/ H_2O with 5 hour exposure times at 90°C . Methanol pretreatment successfully increased the AlO_x loading from 13 wt% to 30 wt%.

Figure 35 is the toluene adsorption isotherms measured at 25°C which show the influence of interpenetrating metal oxide networks on the interaction between toluene and PIM-1 membranes.

Figure 36 is the H_2O sorption isotherms measured at 25°C showing the influence of interpenetrating metal oxide networks on the interaction between water and PIM-1 membranes.

Figure 37 is the contact angle measurements showing the influence of interpenetrating metal oxide networks on the interaction between water and PIM-1 membranes.

Figure 38 is the dissolution of PIM-1 and AlO_x /PIM-1 membranes in THF determined via UV-Vis showing the influence of VPI chemistry on the chemical stability of the hybrid membranes. The dashed lines are included to guide the eye.

Figure 39 is a schematic diagram of a cross-flow organic solvent permeation system.

Figure 40 is a photograph illustrating the organic solvent nanofiltration performance of PIM-1 and AlO_x /PIM-1 hybrid membranes. 10 ppm Rose Bengal ethanol permeate before (left) and after filtration by PIM-1 (center) and AlO_x /PIM-1 (right) hollow fiber membranes.

Figure 41 is a plot of the dye rejection in ethanol by PIM-1 and AlO_x /PIM-1 hollow fiber membranes. Owing to stronger affinity to untreated PIM-1, bulkier Rose Bengal

(973.67 g/mol) is retained less than Solvent Blue 38 (782.18 g/mol) and Oil Red (408.505 g/mol). The deviation from polystyrene retention curve is attributed to the strong interactions between dye molecules and PIM-1. In contrast, AlO_x/PIM-1 membranes achieve more than 80% rejection for all three dyes, indicating the infiltrated metal oxide interrupts the interaction between the dye molecules and the membrane.

Figure 42 is a plot of the organic solvent nanofiltration performance of PIM-1 and AlO_x/PIM-1 hybrid membranes. Molecular weight cut-off curves of PIM-1 and AlO_x/PIM-1 thin film composites in ethanol and n-heptane using polystyrene oligomers as markers. The dashed lines are included to guide the eye.

Figure 43 is a plot of the organic solvent nanofiltration performance of PIM-1 and AlO_x/PIM-1 hybrid membranes. Steady-state ethanol and n-heptane permeance of PIM-1 and AlO_x/PIM-1 thin composite films under 10-bar transmembrane pressure.

Figure 44 is a plot of the long-term ethanol and heptane permeance of PIM-1 and AlO_x/PIM-1 thin composite films. Transmembrane pressure is 10 bar. The rapid reduction of permeance during initial period may contribute to the deformation of support membranes. The grey lines are included to guide the eye.

Figure 45 is a schematic diagram and plot of the porosity in the polymer of intrinsic microporosity 1 (PIM-1).

Figure 46 shows the synthesis and structure of the polymer of intrinsic microporosity 1 (PIM-1).

Figure 47 is a schematic diagram of the steps in the VPI process.

Figure 48 is an EDX diagram of an infiltrated PIM-1 sample.

Figure 49 is the zinc loading profile across the membrane shown in Figure 48, showing that some level of infiltration was achieved throughout the entire.

Figure 50 is a graph of the amount of metal oxide loaded for an infiltration of PIM-1 at 90°C with 300 minute holds and 2 cycles with precursors of diethylzinc (DEZ), trimethylaluminum (TMA), and titanium tetrachloride (TiCl₄).

Figure 51 is a graph of the amount of metal oxide loaded for an infiltration of PIM-1 with TMA and H₂O at 90°C with various cycle numbers and hold times.

Figure 52 is a plot of the water uptake for various PIM-1 samples, showing the effect of the VPI parameters on the hydrophilicity of PIM-1.

Figure 53 shows the contact angle for various PIM-1 samples, showing the effect of the VPI parameters on the hydrophilicity of PIM-1.

Figure 54 shows the effect of ethanol on the swelling of various PIM-1 samples.

Figure 55 shows that the VPI parameters can be used to balance the metal oxide loading with the effect on BET surface area of the hybrid samples.

Figure 56 shows the effect of immersing various PIM-1 samples in THF for 30
5 seconds.

Figure 57 shows the effect of immersing various PIM-1 samples in THF for 2 hours.

Figure 58 shows that a DEX infiltrated PIM-1 sample was stable after being immersed in THF for one week.

Figure 59 shows that a TMA infiltrated PIM-1 sample was stable after being
10 immersed in THF for one week.

Figure 60 shows the effect of immersing various PIM-1 samples in THF for one week.

DETAILED DESCRIPTION

The compositions and methods described herein may be understood more readily by
15 reference to the following detailed description of specific aspects of the disclosed subject matter and the Examples included therein.

Before the present compositions and methods are disclosed and described, it is to be understood that the aspects described below are not limited to specific synthetic methods or specific reagents, as such may, of course, vary. It is also to be understood that the
20 terminology used herein is for the purpose of describing particular aspects only and is not intended to be limiting.

Also, throughout this specification, various publications are referenced. The disclosures of these publications in their entireties are hereby incorporated by reference into this application in order to more fully describe the state of the art to which the disclosed
25 matter pertains. The references disclosed are also individually and specifically incorporated by reference herein for the material contained in them that is discussed in the sentence in which the reference is relied upon.

In this specification and in the claims that follow, reference will be made to a number of terms, which shall be defined to have the following meanings.

30 Throughout the description and claims of this specification the word “comprise” and other forms of the word, such as “comprising” and “comprises,” means including but not limited to, and is not intended to exclude, for example, other additives, components, integers, or steps.

As used in the description and the appended claims, the singular forms “a,” “an,” and “the” include plural referents unless the context clearly dictates otherwise. Thus, for example, reference to “a composition” includes mixtures of two or more such compositions, reference to “an agent” includes mixtures of two or more such agents, reference to “the component” includes mixtures of two or more such components, and the like.

“Optional” or “optionally” means that the subsequently described event or circumstance can or cannot occur, and that the description includes instances where the event or circumstance occurs and instances where it does not.

Ranges can be expressed herein as from “about” one particular value, and/or to “about” another particular value. By “about” is meant within 5% of the value, e.g., within 4, 3, 2, or 1% of the value. When such a range is expressed, another aspect includes from the one particular value and/or to the other particular value. Similarly, when values are expressed as approximations, by use of the antecedent “about,” it will be understood that the particular value forms another aspect. It will be further understood that the endpoints of each of the ranges are significant both in relation to the other endpoint, and independently of the other endpoint.

It is understood that throughout this specification the identifiers “first” and “second” are used solely to aid in distinguishing the various components and steps of the disclosed subject matter. The identifiers “first” and “second” are not intended to imply any particular order, amount, preference, or importance to the components or steps modified by these terms.

Hybrid Membranes

Disclosed herein are hybrid membranes comprising: a microporous polymer, the microporous polymer comprising a continuous polymer phase permeated by a continuous pore phase; and an atomic scale inorganic material dispersed throughout the microporous polymer within the continuous pore phase.

“Phase,” as used herein, generally refers to a region of a material having a substantially uniform composition which is a distinct and physically separate portion of a heterogeneous system. The term “phase” does not imply that the material making up a phase is a chemically pure substance, but merely that the chemical and/or physical properties of the material making up the phase are essentially uniform throughout the material, and that these chemical and/or physical properties differ significantly from the chemical and/or physical properties of another phase within the material. Examples of

physical properties include density, thickness, aspect ratio, specific surface area, porosity and dimensionality. Examples of chemical properties include chemical composition.

“Continuous,” as used herein, generally refers to a phase such that all points within the phase are directly connected, so that for any two points within a continuous phase, there
5 exists a path which connects the two points without leaving the phase.

As used herein, an “atomic scale inorganic material” means that substantially no particles or crystals of the inorganic material are formed as determined by XRD and/or TEM. The hybrid membranes described herein comprise 1 wt% or less (e.g., 0.75 wt% or less, 0.5 wt% or less, 0.25 wt% or less, or 0.1 wt% or less) of particles comprising the
10 inorganic material. The hybrid membranes described herein comprise 1 wt% or less (e.g., 0.75 wt% or less, 0.5 wt% or less, 0.25 wt% or less, or 0.1 wt% or less) of particles comprising the inorganic material, the particles having an average particle size of 1 nm or more.

Microporous polymers include, but are not limited to, polymers of intrinsic
15 microporosity (PIMs), hypercrosslinked microporous polymers (HCPs), covalent organic frameworks (COFs), conjugated microporous polymers (CMPs), porous aromatic frameworks (PAFs), porous organic cages (POCs), and the like, for example as described in “Porous Polymers: design, synthesis and applications” by Qiu et al. (Qiu et al. “Porous Polymers: design, synthesis and applications,” Royal Society of Chemistry, 2015).

20 In some examples, the microporous polymer can comprise a polymer of intrinsic microporosity. The polymer of intrinsic microporosity can comprise any suitable polymer of microporosity. For example, the polymer of intrinsic microporosity can comprise any of those described in “Polymers of Intrinsic Microporosity” by Neil B. McKeown (International Scholarly Research Network, volume 2012, article ID 513986, 16 pages, doi:
25 10.5402/2012/513986); US8623928; WO2003000774; and/or WO2005012397, each of which is hereby incorporated by reference herein in its entirety for its teaching on polymers of intrinsic microporosity. In some examples, the polymer of intrinsic microporosity can comprise PIM-1, PIM-2, PIM-3, PIM-4, PIM-5, PIM-6, PIM-7, PIM-8, PIM-9, PIM-10, KAUST-PI-X (e.g., KAUST-PI-1, KAUST PI-2), triptycene based polymers of intrinsic
30 microporosity, derivatives thereof, or combinations thereof. In some examples, the polymer of intrinsic microporosity can comprise PIM-1 or a derivative thereof.

The inorganic material can, for example, comprise an inorganic oxide, and inorganic nitride, and inorganic carbide, and inorganic oxynitride, and inorganic oxycarbide, or

combinations thereof. In some examples, the inorganic material can comprise a metal compound, a metalloid compound, or a combination thereof. For example, the inorganic material can comprise a metal oxide, a metal nitride, a metal carbide, a metal oxynitride, a metal oxycarbide, a metalloid oxide, a metalloid nitride, a metalloid carbide, a metalloid oxynitride, a metalloid oxycarbide, or combinations thereof.

For example, the inorganic material can comprise a metal selected from the group consisting of Mg, Al, Ca, Sc, Ti, V, Cr, Mn, Fe, Co, Ni, Cu, Zn, Ga, Sr, Y, Zr, Nb, Mo, Tc, Ru, Rh, Pd, Ag, Cd, In, Sn, Ba, Hf, Ta, W, Re, Os, Ir, Pt, Au, Hg, Tl, Pb, Bi, La, Ce, Pr, Nd, Pm, Sm, Eu, Gd, Tb, Dy, Ho, Er, Tm, Yb, and combinations thereof. In some examples, the inorganic material can comprise a metalloid selected from the group consisting of Si, Ge, As, Sb, Te, and combinations thereof. In certain examples, the inorganic material can comprise a metal or a metalloid selected from the group consisting of Al, Zn, Ti, Hf, Zr, Ta, Y, Si, and combinations thereof.

In some examples, the inorganic material can comprise a metal oxide, a metalloid oxide, or a combination thereof. In certain examples, the metal oxide, metalloid oxide, or combination thereof can comprise a metal or metalloid selected from the group consisting of Al, Zn, Ti, Hf, Zr, Ta, Y, Si, and combinations thereof. For example, the inorganic material can comprise ZnO, Al₂O₃, TiO₂, HfO₂, ZrO₂, Ta₂O₅, Y₂O₅, SiO₂, Ir₂O₃, RuO₂, WO₃, Ni₂O₃, or a combination thereof.

The inorganic material can, in some examples, be dispersed substantially homogeneously throughout the hybrid membrane. In some examples, the inorganic material is not chemically bound to microporous polymer.

In some examples, the inorganic material can form a continuous inorganic phase within the continuous pore phase. In certain examples, the hybrid membrane can comprise an interpenetrative network of the continuous polymer phase, the continuous inorganic phase, and the continuous pore phase.

The hybrid membrane can comprise any suitable amount of the inorganic material. For example, the hybrid membrane can comprise 0.1 wt% or more of the inorganic material based on the weight of the hybrid membrane (e.g., 0.5 wt% or more, 1 wt% or more, 1.5 wt % or more, 2 wt % or more, 2.5 wt % or more, 3 wt % or more, 3.5 wt % or more, 4 wt % or more, 4.5 wt % or more, 5 wt % or more, 5.5 wt % or more, 6 wt % or more, 6.5 wt % or more, 7 wt % or more, 7.5 wt % or more, 8 wt % or more, 8.5 wt % or more, 9 wt % or more, 9.5 wt % or more, 10 wt % or more, 11 wt % or more, 12 wt % or more, 13

wt % or more, 14 wt % or more, 15 wt % or more, 20 wt % or more, 25 wt % or more, or 30 wt % or more). In some examples, the hybrid membrane can comprise 35 wt% or less of the inorganic material based on the weight of the hybrid membrane (e.g., 30 wt% or less, 25 wt% or less, 20 wt% or less, 15 wt% or less, 14 wt% or less, 13 wt% or less, 12 wt% or less, 11 wt% or less, 10 wt% or less, 9.5 wt% or less, 9 wt% or less, 8.5 wt% or less, 8 wt% or less, 7.5 wt% or less, 7 wt% or less, 6.5 wt% or less, 6 wt% or less, 5.5 wt% or less, 5 wt% or less, 4.5 wt% or less, 4 wt% or less, 3.5 wt% or less, 3 wt% or less, 2.5 wt% or less, 2 wt% or less, or 1 wt% or less). The amount of inorganic material in the hybrid membrane can range from any of the minimum values described above to any of the maximum values described above. For example, the hybrid membrane can comprise from 0.1 wt% to 35 wt% of the inorganic material based on the weight of the hybrid membrane (e.g., from 0.1 wt% to 30 wt%, from 0.1 wt% to 20 wt%, from 0.1 wt% to 13 wt%, from 0.1 wt% to 10 wt%, from 1 wt% to 10 wt%, from 0.1 wt% to 8.5 wt%, or from 1 wt% to 8.5 wt%).

In some examples, the microporous polymer can comprise a polymer of intrinsic microporosity and the inorganic material can comprise a metal oxide. In some examples, the microporous polymer can comprise a polymer of intrinsic microporosity and the inorganic material can comprise a metal oxide comprising a metal selected from the group consisting of Al, Zn, and Ti. In some examples, the microporous polymer can comprise a polymer of intrinsic microporosity and the inorganic material can comprise a metal oxide selected from the group consisting of ZnO, Al₂O₃, and TiO₂.

In some examples, the microporous polymer can comprise polymer of intrinsic microporosity-1 (PIM-1) and the inorganic material can comprise a metal oxide. In some examples, the microporous polymer can comprise PIM-1 and the inorganic material can comprise a metal oxide comprising a metal selected from the group consisting of Al, Zn, and Ti. In some examples, the microporous polymer can comprise PIM-1 and the inorganic material can comprise a metal oxide selected from the group consisting of ZnO, Al₂O₃, and TiO₂.

In some examples, the inorganic material can comprise a metal oxide and the hybrid membrane can comprise from 0.1 wt% to 10 wt% or from 0.1 wt% to 8.5 wt% of the atomic scale metal oxide. In some examples, the inorganic material can comprise a metal oxide comprising a metal selected from the group consisting of Al, Zn, and Ti, and the hybrid membrane can comprise from 0.1 wt% to 10 wt% or from 0.1 wt% to 8.5 wt% of the atomic scale metal oxide. In some examples, the inorganic material can comprise a metal oxide

selected from the group consisting of ZnO, Al₂O₃, and TiO₂ and the hybrid membrane can comprise from 0.1 wt% to 10 wt% or from 0.1 wt% to 8.5 wt% of the atomic scale metal oxide.

5 In some examples, the microporous polymer can comprise a polymer of intrinsic microporosity, the inorganic material can comprise a metal oxide, and the hybrid membrane can comprise from 0.1 wt% to 10 wt% or from 0.1 wt% to 8.5 wt% of the atomic scale metal oxide. In some examples, the microporous polymer can comprise a polymer of intrinsic microporosity, the inorganic material can comprise a metal oxide comprising a metal selected from the group consisting of Al, Zn, and Ti, and the hybrid membrane can
10 comprise from 0.1 wt% to 10 wt% or from 0.1 wt% to 8.5 wt% of the atomic scale metal oxide. In some examples, the microporous polymer can comprise a polymer of intrinsic microporosity, the inorganic material can comprise a metal oxide selected from the group consisting of ZnO, Al₂O₃, and TiO₂, and the hybrid membrane can comprise from 0.1 wt% to 10 wt% or from 0.1 wt% to 8.5 wt% of the atomic scale metal oxide.

15 In some examples, the microporous polymer can comprise polymer of intrinsic microporosity-1 (PIM-1), the inorganic material can comprise a metal oxide, and the hybrid membrane can comprise from 0.1 wt% to 10 wt% or from 0.1 wt% to 8.5 wt% of the atomic scale metal oxide. In some examples, the microporous polymer can comprise polymer of intrinsic microporosity-1 (PIM-1), the inorganic material can comprise a metal oxide
20 comprising a metal selected from the group consisting of Al, Zn, and Ti, and the hybrid membrane can comprise from 0.1 wt% to 10 wt% or from 0.1 wt% to 8.5 wt% of the atomic scale metal oxide. In some examples, the microporous polymer can comprise polymer of intrinsic microporosity-1 (PIM-1), the inorganic material can comprise a metal oxide selected from the group consisting of ZnO, Al₂O₃, and TiO₂, and the hybrid membrane can
25 comprise from 0.1 wt% to 10 wt% or from 0.1 wt% to 8.5 wt% of the atomic scale metal oxide.

In some examples, the hybrid membrane can have a BET surface area of 200 m²/g or more (e.g., 250 m²/g or more, 300 m²/g or more, 350 m²/g or more, 400 m²/g or more, 450 m²/g or more, 500 m²/g or more, 600 m²/g or more, 700 m²/g or more, 800 m²/g or more,
30 900 m²/g or more, 1000 m²/g or more, 1100 m²/g or more, 1200 m²/g or more, 1300 m²/g or more, 1400 m²/g or more, 1500 m²/g or more, 1600 m²/g or more, 1700 m²/g or more, or 1800 m²/g or more). The hybrid membrane can, for example, have a BET surface area of 2000 m²/g or less (e.g., 1900 m²/g or less, 1800 m²/g or less, 1700 m²/g or less, 1600 m²/g

or less, 1500 m²/g or less, 1400 m²/g or less, 1300 m²/g or less, 1200 m²/g or less, 1100 m²/g or less, 1000 m²/g or less, 900 m²/g or less, 800 m²/g or less, 700 m²/g or less, 600 m²/g or less, 500 m²/g or less, 450 m²/g or less, 400 m²/g or less, 350 m²/g or less, or 300 m²/g or less). The BET surface area of the hybrid membrane can range from any of the
5 minimum values described above to any of the maximum values described above. For example, the hybrid membrane can have a BET surface area of from 200 m²/g to 2000 m²/g (e.g., from 200 m²/g to 1100 m²/g, from 1100 m²/g to 2000 m²/g, from 200 m²/g to 1400 m²/g, from 1400 m²/g to 2000 m²/g, from 200 m²/g to 900 m²/g, from 500 m²/g to 800 m²/g, or from 500 m²/g to 1200 m²/g).

10 In some examples, the inorganic material can comprise a metal oxide and the hybrid membrane can have a BET surface area of from 500 m²/g to 800 m²/g. In some examples, the inorganic material can comprise a metal oxide comprising a metal selected from the group consisting of Al, Zn, and Ti, and the hybrid membrane can have a BET surface area of from 500 m²/g to 800 m²/g. In some examples, the inorganic material can comprise a
15 metal oxide selected from the group consisting of ZnO, Al₂O₃, and TiO₂ and the hybrid membrane can have a BET surface area of from 500 m²/g to 800 m²/g.

In some examples, the inorganic material can comprise a metal oxide, the hybrid membrane can comprise from 0.1 wt% to 10 wt% or from 0.1 wt% to 8.5 wt% of the atomic scale metal oxide, and the hybrid membrane can have a BET surface area of from 500 m²/g
20 to 800 m²/g. In some examples, the inorganic material can comprise a metal oxide comprising a metal selected from the group consisting of Al, Zn, and Ti; the hybrid membrane can comprise from 0.1 wt% to 10 wt% or from 0.1 wt% to 8.5 wt% of the atomic scale metal oxide; and the hybrid membrane can have a BET surface area of from 500 m²/g to 800 m²/g. In some examples, the inorganic material can comprise a metal oxide selected
25 from the group consisting of ZnO, Al₂O₃, and TiO₂; the hybrid membrane can comprise from 0.1 wt% to 10 wt% or from 0.1 wt% to 8.5 wt% of the atomic scale metal oxide; and the hybrid membrane can have a BET surface area of from 500 m²/g to 800 m²/g.

In some examples, the microporous polymer can comprise a polymer of intrinsic microporosity, the inorganic material can comprise a metal oxide, and the hybrid membrane
30 can have a BET surface area of from 500 m²/g to 800 m²/g. In some examples, the microporous polymer can comprise a polymer of intrinsic microporosity, the inorganic material can comprise a metal oxide comprising a metal selected from the group consisting of Al, Zn, and Ti, and the hybrid membrane can have a BET surface area of from 500 m²/g

to 800 m²/g. In some examples, the microporous polymer can comprise a polymer of intrinsic microporosity, the inorganic material can comprise a metal oxide selected from the group consisting of ZnO, Al₂O₃, and TiO₂, and the hybrid membrane can have a BET surface area of from 500 m²/g to 800 m²/g.

5 In some examples, the microporous polymer can comprise a polymer of intrinsic microporosity, the inorganic material can comprise a metal oxide, the hybrid membrane can comprise from 0.1 wt% to 10 wt% or from 0.1 wt% to 8.5 wt% of the atomic scale metal oxide, and the hybrid membrane can have a BET surface area of from 500 m²/g to 800 m²/g. In some examples, the microporous polymer can comprise a polymer of intrinsic
10 microporosity; the inorganic material can comprise a metal oxide comprising a metal selected from the group consisting of Al, Zn, and Ti; the hybrid membrane can comprise from 0.1 wt% to 10 wt% or from 0.1 wt% to 8.5 wt% of the atomic scale metal oxide; and the hybrid membrane can have a BET surface area of from 500 m²/g to 800 m²/g. In some examples, the microporous polymer can comprise a polymer of intrinsic microporosity; the
15 inorganic material can comprise a metal oxide selected from the group consisting of ZnO, Al₂O₃, and TiO₂; the hybrid membrane can comprise from 0.1 wt% to 10 wt% or from 0.1 wt% to 8.5 wt% of the atomic scale metal oxide; and the hybrid membrane can have a BET surface area of from 500 m²/g to 800 m²/g.

 In some examples, the microporous polymer can comprise polymer of intrinsic
20 microporosity-1 (PIM-1), the inorganic material can comprise a metal oxide, and the hybrid membrane can have a BET surface area of from 500 m²/g to 800 m²/g. In some examples, the microporous polymer can comprise PIM-1, the inorganic material can comprise a metal oxide comprising a metal selected from the group consisting of Al, Zn, and Ti, and the hybrid membrane can have a BET surface area of from 500 m²/g to 800 m²/g. In some
25 examples, the microporous polymer can comprise PIM-1, the inorganic material can comprise a metal oxide selected from the group consisting of ZnO, Al₂O₃, and TiO₂, and the hybrid membrane can have a BET surface area of from 500 m²/g to 800 m²/g.

 In some examples, the microporous polymer can comprise PIM-1, the inorganic material can comprise a metal oxide, the hybrid membrane can comprise from 0.1 wt% to
30 10 wt% or from 0.1 wt% to 8.5 wt% of the atomic scale metal oxide, and the hybrid membrane can have a BET surface area of from 500 m²/g to 800 m²/g. In some examples, the microporous polymer can comprise PIM-1; the inorganic material can comprise a metal oxide comprising a metal selected from the group consisting of Al, Zn, and Ti; the hybrid

membrane can comprise from 0.1 wt% to 10 wt% or from 0.1 wt% to 8.5 wt% of the atomic scale metal oxide; and the hybrid membrane can have a BET surface area of from 500 m²/g to 800 m²/g. In some examples, the microporous polymer can comprise PIM-1; the inorganic material can comprise a metal oxide selected from the group consisting of ZnO, Al₂O₃, and TiO₂; the hybrid membrane can comprise from 0.1 wt% to 10 wt% or from 0.1 wt% to 8.5 wt% of the atomic scale metal oxide; and the hybrid membrane can have a BET surface area of from 500 m²/g to 800 m²/g.

The microporous polymer can be solution processed into a variety of configurations such that the hybrid membrane can have a variety of configurations. For example, the hybrid membrane can comprise a film, a fiber, a free-standing membrane, a spiral wound membrane, a 3D printed membrane, or a combination thereof. In some examples, the hybrid membrane can comprise a hollow fiber.

The hybrid membranes described herein can be more stable in a solvent than the corresponding microporous polymer in the absence of the atomic scale inorganic material. As used herein, "more stable" means that the hybrid membrane exhibits less swelling and/or dissolution than the corresponding microporous polymer in the absence of the atomic scale inorganic material over the same amount of time. Examples of suitable solvents include, but are not limited to ketones (e.g., acetone, methyl ethyl ketone, diethyl ketone, methyl *n*-propyl ketone, acetophenone, and cyclohexanone); linear, poly and cyclic ethers (e.g., diethyl ether, di-*n*-propyl ether, di-*n*-butyl ether, ethyl *n*-propyl ether, glyme, diglyme, tetrahydrofuran, 1,4-dioxane, 1,3-dioxolane); aromatic hydrocarbons (e.g., toluene, ethyl benzene, xylenes); alcohols (e.g., methanol, ethanol, 1-propanol, 2-propanol, isomers of butanol, isomers of pentanol, ethylene glycol, propylene glycol, glycerol); dimethylformamide (DMF); dimethoxyethane; dimethylacetamide; N-methylpyrrolidone; dimethylsulfoxide (DMSO); chloroform; dichloromethane; acetonitrile (MeCN); ethyl acetate; propylene carbonate; and combinations thereof.

For example, the hybrid membranes can be more stable in toluene, tetrahydrofuran, chloroform, dichloromethane, or a combination thereof than the corresponding microporous polymer in the absence of the atomic scale inorganic material. The hybrid membrane, for example, can have a lower toluene uptake at a P/P^{sat} of 0.25 or more, a lower ethanol permeance, a lower *n*-heptane permeance, or a combination thereof than the corresponding microporous polymer in the absence of the atomic scale inorganic material.

In some examples, the hybrid membrane can be stable in a solvent for 1 hour or more (e.g., 2 hours or more, 3 hours or more, 4 hours or more, 6 hours or more, 12 hours or more, 1 day or more, 2 days or more, 3 days or more, 4 days or more, 5 days or more, 6 days or more, 1 week or more, 2 weeks or more, 3 weeks or more, 1 month or more, 2 months or more, 3 months or more, 6 months or more, 9 months or more, 1 year or more, 2 years or more, 3 years or more, 4 years or more, or 5 years or more). As used herein, “stable” means that 10 wt% or less of the hybrid membrane dissolves in the solvent over the time frame. Examples of suitable solvents include, but are not limited to ketones (e.g., acetone, methyl ethyl ketone, diethyl ketone, methyl *n*-propyl ketone, acetophenone, and cyclohexanone); linear, poly and cyclic ethers (e.g., diethyl ether, di-*n*-propyl ether, di-*n*-butyl ether, ethyl *n*-propyl ether, glyme, diglyme, tetrahydrofuran, 1,4-dioxane, 1,3-dioxolane); aromatic hydrocarbons (e.g., toluene, ethyl benzene, xylenes); alcohols (e.g., methanol, ethanol, 1-propanol, 2-propanol, isomers of butanol, isomers of pentanol, ethylene glycol, propylene glycol, glycerol); dimethylformamide (DMF); dimethoxyethane; dimethylacetamide; N-methylpyrrolidone; dimethylsulfoxide (DMSO); chloroform; dichloromethane; acetonitrile (MeCN); ethyl acetate; propylene carbonate; and combinations thereof.

In some examples, the hybrid membrane can be stable in tetrahydrofuran, chloroform, dichloromethane, or a combination thereof for 1 hour or more (e.g., 2 hours or more, 3 hours or more, 4 hours or more, 6 hours or more, 12 hours or more, 1 day or more, 2 days or more, 3 days or more, 4 days or more, 5 days or more, 6 days or more, 1 week or more, 2 weeks or more, 3 weeks or more, 1 month or more, 2 months or more, 3 months or more, 6 months or more, 9 months or more, 1 year or more, 2 years or more, 3 years or more, 4 years or more, or 5 years or more).

25 ***Methods of Making***

Also described herein are methods of making any of the hybrid membranes described herein. For example, also described herein are methods of making any of the hybrid membranes described herein, the method comprising infiltrating the microporous polymer with the inorganic material using vapor phase infiltration. Vapor phase infiltration is described, for example, in US Patent Application No. 2018/0127870, which is hereby incorporated by reference herein in its entirety for its teaching on VPI.

In some examples, the vapor phase infiltration can comprise exposing the microporous polymer to a precursor, thereby forming an impregnated membrane. The

precursor can, for example, comprise a metal-organic precursor, a metalloid-organic precursor, or a combination thereof. The precursor can, for example, comprise a metal alkyl compound, a metalloid alkyl compound, a metal halide, a metalloid halide, a metal tetrakisalkylamido compound, a metalloid tetrakisalkylamido compound, a metal
5 cyclopentadienyl compound, a metalloid cyclopentadienyl compound, a metal ketonate, a metalloid ketonate, other similar metal-organic and/or metalloid-organic species with sufficient vapor pressure to be delivered in the gaseous phase, and combinations thereof. The vapor phase infiltration can, for example, further comprise exposing the impregnated membrane to a reactant, thereby forming the inorganic material. The reactant can, for
10 example, comprise an oxidant (e.g., oxygen, ozone, hydrogen peroxide, water, etc.), a nitrogen containing compound (e.g., ammonia, hydrazine, etc.), a carbonaceous compound (e.g., methane), or a combination thereof.

In certain examples, the vapor phase infiltration can comprise exposing the microporous polymer to a metal-organic precursor comprising trimethylaluminum (TMA),
15 diethylzinc (DEZ), titanium tetrachloride (TiCl₄), titanium isopropoxide, or a combination thereof, thereby forming an impregnated membrane. The vapor phase infiltration can, for example, further comprise exposing the impregnated membrane to an oxidant comprising water, oxygen, or a combination thereof, thereby forming the inorganic material which comprises a metal oxide.

20 The vapor phase infiltration can, in some examples, be conducted at a temperature of 0°C or more (e.g., 10°C or more, 20°C or more, 30°C or more, 40°C or more, 50°C or more, 60°C or more, 70°C or more, 80°C or more, 90°C or more, 100°C or more, 110°C or more, 120°C or more, 130°C or more, 140°C or more, 150°C or more, 175°C or more, 200°C or more, 225°C or more, 250°C or more, 300°C or more, 350°C or more, or 400°C or
25 more). In some examples, the vapor phase infiltration can be conducted at a temperature of 450°C or less (e.g., 400°C or less, 350°C or less, 300°C or less, 250°C or less, 225°C or less, 200°C or less, 175°C or less, 150°C or less, 140°C or less, 130°C or less, 120°C or less, 110°C or less, 100°C or less, 90°C or less, 80°C or less, 70°C or less, 60°C or less, 50°C or less, 40°C or less, 30°C or less, or 20°C or less). The temperature at which the
30 vapor phase infiltration can be conducted can range from any of the minimum values described above to any of the maximum values described above. For example, the vapor phase infiltration can be conducted at a temperature of from 0°C to 450°C (e.g., from 70°C to 250°C, from 80°C to 120°C, from 90°C to 110°C, from 85°C to 95°C, or from 105°C to

115°C). In certain examples, the vapor phase infiltration can be conducted at a temperature of 90°C or 110°C.

In some examples, the methods can comprise performing one or more cycles of vapor phase infiltration to make the hybrid membrane (e.g., 2 or more, 3 or more, 4 or
5 more, 5 or more, 6 or more, 7 or more, 8 or more, 9 or more, or 10 or more).

The methods can, in some examples, further comprise pre-treating the microporous polymer prior to performing the vapor phase infiltration. For example, pre-treating the microporous polymer can comprise contacting the microporous polymer with an alcohol (e.g., methanol, ethanol, 1-propanol, 2-propanol, isomers of butanol, isomers of pentanol,
10 ethylene glycol, propylene glycol, glycerol); dimethylfuran; n-methylpyrrolidone; or a combination thereof. In some examples, pre-treating the microporous polymer can comprise contacting the microporous polymer with methanol.

In some examples, the methods can be performed *in situ*, such that, for example, the hybrid membrane can be formed *in situ* in a membrane module.

15 ***Methods of Use***

Also disclosed herein are methods of use of the hybrid membranes described herein. For example, the hybrid membranes can be used in various articles of manufacture, such as, for example, gas storage devices and/or sensors. Such articles of manufacture can be fabricated by methods known in the art.

20 In some examples, the hybrid membranes described herein can be used as a sorbent, as a catalyst support, or a combination thereof.

In some examples, the hybrid membranes described herein can be used in a membrane separation. The hybrid membrane can, for example, exhibit better separation performance in the membrane separation than the corresponding microporous polymer in
25 the absence of the atomic scale inorganic material. In some examples, the hybrid membrane can exhibit a higher rejection of a solute (e.g., a sorptive solute) in a membrane separation than the corresponding microporous polymer in the absence of the atomic scale inorganic material. The hybrid membrane can, for example, reject more dye in a dye separation than the corresponding microporous polymer in the absence of the atomic scale inorganic
30 material.

The hybrid membrane can, for example, exhibit a better size-based separation performance in plasticizing solvents than the corresponding microporous polymer in the absence of the atomic scale inorganic material. For example, the hybrid membrane can

exhibit a lower molecular weight cutoff for a size-based separation than the corresponding microporous polymer in the absence of the atomic scale inorganic material.

A number of embodiments of the invention have been described. Nevertheless, it will be understood that various modifications may be made without departing from the spirit and scope of the invention. Accordingly, other embodiments are within the scope of the following claims.

The examples below are intended to further illustrate certain aspects of the systems and methods described herein, and are not intended to limit the scope of the claims.

EXAMPLES

The following examples are set forth below to illustrate the methods and results according to the disclosed subject matter. These examples are not intended to be inclusive of all aspects of the subject matter disclosed herein, but rather to illustrate representative methods and results. These examples are not intended to exclude equivalents and variations of the present invention which are apparent to one skilled in the art.

Efforts have been made to ensure accuracy with respect to numbers (e.g., amounts, temperature, etc.) but some errors and deviations should be accounted for. Unless indicated otherwise, parts are parts by weight, temperature is in °C or is at ambient temperature, and pressure is at or near atmospheric. There are numerous variations and combinations of measurement conditions, e.g., component concentrations, temperatures, pressures and other measurement ranges and conditions that can be used to optimize the described process.

Example 1

Modern chemical manufacturing depends on efficient chemical separations. Today, most separations are achieved with energy-intensive thermal approaches based on phase changes (e.g., distillation), which account for 10-15% of global energy usage (Sholl et al. *Nature* 2016, 532, 435–437). In contrast, membrane separations—which differentiate molecules based on variations in molecular size, shape, and physicochemical interaction parameters—require minimal energy input. For instance, membrane-based desalination uses 90% less energy than the most optimized thermally driven processes (Koros et al. *AIChE J.* 2012, 58, 2624–2633).

Most current commercial membrane separation technologies are deployed for gaseous chemicals or aqueous media (e.g., brine). However, membrane usage in organic solvent separation (e.g., xylene separation, organic solvent dehydration, product separation

of synthesis solution, etc.) is becoming more prevalent in the modern chemical industry due to its potential energy savings. For instance, the separation of benzene derivatives requires approximately 430 TWh of energy each year (Sholl et al. *Nature* 2016, 532, 435–437); membrane processes such as organic solvent nanofiltration (OSN) and organic solvent reverse osmosis (OSRO) can potentially drive this energy cost down by an order of magnitude (Koh et al. *Science* 2018, 353, 804–807). For successful integration into industrial processing, organic solvent nanofiltration processes require membranes that retain their mechanical integrity and microstructure when operating in aggressive organic solvents (Marchetti et al. *Chem. Rev.* 2014, 114, 10735–10806). While inorganic membranes, like zeolites, are inherently stable in organic solvents, they are costly and challenging to scale up in a defect-free manner (Kosinov et al. *J. Memb. Sci.* 2016, 499, 65–79). Polymer membranes can be mass-produced defect-free but lack the requisite levels of organic solvent stability.

One polymer membrane material of interest for organic solvent nanofiltration is polymer of intrinsic microporosity 1 (PIM-1). At ambient conditions, PIM-1 is a rigid, glassy polymer with high levels of microporosity that is solution-processable, but, like other polymer membranes, it has limited stability and selectivity when exposed to plasticizing solvents or highly sorptive solutes (Zhang et al. *Macromol. Rapid Commun.* 2018, 39, 1800274; Budd et al. *Adv. Mater.* 2004, 16, 456–459; Cook et al. *J. Memb. Sci.* 2018, 558, 52–63; Tsarkov et al. *J. Memb. Sci.* 2012, 423–424, 65–72). Several post-fabrication techniques have been developed to enhance the solvent stability of polymer membranes like PIM-1, including crosslinking to create interconnected polymer networks and thermal pyrolysis to create carbon molecular sieves (Koh et al. *Science* 2018, 353, 804–807; Marchetti et al. *Chem. Rev.* 2014, 114, 10735–10806; Koh et al. *Nat. Nanotechnol.* 2015, 10, 385–386; Ma et al. *J. Memb. Sci.* 2018, 564, 404–414). While these techniques show promise towards creating solvent-stable scalable membranes, both lead to dramatic changes in the membrane's microscopic structure and higher probability of defect formation. These post-fabrication techniques also require large amounts of chemicals or additional equipment that generate added costs.

Vapor phase infiltration (VPI) is a gas-phase, solvent-free process that has emerged from the atomic layer deposition (ALD) community to load polymer free volume with inorganics, frequently metal oxides (Leng et al. *Mater. Horizons* 2017, 4, 747–771; Azpitarte et al. *MRS Commun.* 2018, 8, 727–741; Subramanian et al. *JOM* 2018

doi:10.1007/s11837-018-3141-4; Ingram et al. *JOM* 2018 doi:10.1007/s11837-018-3157-9). VPI has been shown to strengthen spider silk and provide UV protection to Kevlar fibers (Lee et al. *Science* 2009, 324, 488–92; Azpitarte et al. *Chem. Mater.* 2017, 29, 10068–10074). Different from crosslinking or pyrolysis, VPI leaves the polymer microstructure and macroscale form factor unchanged (Obuchovsky et al. *Chem. Mater.* 2016, 28, 2668–2676; Padbury et al. *J. Phys. Chem. C* 2014, 118, 18805–18813). A further advantage of VPI is the ease of large-scale application. Whereas crosslinking requires processing of new solvents and chemicals and pyrolysis requires high temperatures (> 400 °C), VPI can be accomplished within the standard membrane modules with minimal investment in additional equipment. The mild reaction environment (rough vacuum and 90 °C) can be supplied by general vacuum pumps and heating media.

Herein, vapor phase infiltration (VPI) was used to synthesize hybrid membranes by infusing polymer of intrinsic microporosity 1 (PIM-1) with inorganic constituents. These hybrid membranes are fundamentally distinct from mixed matrix membranes because the organic and inorganic species form complex networks that interpenetrate at the atomic-scale. Spectroscopy, porosimetry, and microscopy experiments suggest that the metal oxide intercalates throughout the microporous polymer network, thus stabilizing these materials in aggressive solvent environments while still retaining the polymer's macroscale form factor and microporous internal structure. The atomic-scale metal oxide networks within these hybrid membranes protect PIM-1 from swelling or dissolving in organic solvents (e.g., plasticizing solvents) including: tetrahydrofuran, dichloromethane, and chloroform. This stability translates to significantly improved separation performance in such solvents. The hybrid membranes efficiently reject low molecular weight solutes in solvent environments that otherwise result in complete failure of “organic-only” uncrosslinked precursor membranes.

Polymer of intrinsic microporosity 1 (PIM-1) was synthesized via room-temperature condensation of tetrafluoroterephthalonitrile (TFTPN, Alfa Aesar) and 5,5',6,6'-Tetrahydroxy- 3,3,3',3'-tetramethyl-1,1'-spirobisindane (TTSBI, Alfa Aesar) in anhydrous dimethylformamide (DMF, Alfa Aesar) catalyzed by K₂CO₃ (Alfa Aesar) fine powders for 72 hours (Jue et al. *Macromolecules* 2015, 48, 5780–5790; Zhang et al. *Macromol. Rapid Commun.* 2018, 39, 1800274). Prior to synthesis, TTSBI and TFTPN were purified via vacuum sublimation and recrystallization respectively (Jue et al. *Macromolecules* 2015, 48, 5780–5790). Monomers and oligomers were removed by post-synthesis washing using

DMF and methanol. The purified PIM-1 ($M_n = 50,166$; $M_w/M_n = 1.65$) was then stored in sealed jars.

Unless declared, all organic solvents used herein were generic of ACS grade purchased from Sigma-Aldrich or Alfa Aesar without further treatment. Styrene dimers and polystyrene oligomers were purchased from Agilent. Torlon™ 4000 LV was supplied by
5 Solvay. p-Xylylenediamine was purchased from Sigma-Aldrich.

For flat PIM-1 membrane casting, the dry PIM-1 powder was first dissolved in anhydrous chloroform with a mass ratio of 1:200. After complete dissolution, the PIM-1 solution was filtered through a PTFE filter with 0.45 μm pores. The clear yellow PIM-1
10 solution was then transferred into a nitrogen glove bag that had been saturated with chloroform. The PIM-1 solution was then poured into a PTFE petri dish. After 48 hours of slow evaporation, the flat PIM-1 membrane was transferred into a vacuum oven (990 mbar, 80 °C) to dry thoroughly. The thickness of the flat PIM-1 membranes was controlled by varying the amount of PIM-1 solution poured into PTFE petri dishes. These flat PIM-1
15 membranes were then used to study VPI infiltration depth, contact angle, and transmission FTIR.

PIM-1 hollow fiber membranes were fabricated via dry-wet spinning as described by Jue et al. (Jue et al. *J. Memb. Sci.* 2017, 530, 33–41). As a result of phase inversion, PIM-1 hollow fiber membranes exhibit hierarchical porosity, which minimizes the
20 characteristic diffusion length of VPI precursors and results in thorough metal oxide infiltration.

Vapor phase infiltration was carried out in a 1 ft³ (0.028 m³) cubic hot-wall reactor. The reactor size (1 ft³) allows for large-scale processing. The reactor was temperature-controlled using PID controllers. Valves were actuated pneumatically using compressed air
25 and a custom control box. Nitrogen supply was 99.999% purity and was supplied at 250 sccm by a mass flow controller. Precursor bottles and water attachment served as reservoirs for reactive species. A trap was used prior to a rotary vane roughing pump to reduce the presence of reactive species and byproducts in the pump oil.

Prior to infiltration, PIM-1 materials (with the exception of the thin film composites)
30 were soaked in methanol for two hours and dried in a fume hood for 30 minutes. The VPI chamber was operated at 90°C and prior to infiltration was purged with 250 sccm ultrahigh purity nitrogen (Airgas, 99.999%) for between 5 and 15 hours (depending upon mass of PIM-1 in the chamber) to remove excess methanol and water (Figure 1). Following purging,

the chamber was pumped down to baseline (~90 mTorr) (Figure 1). Into the evacuated chamber, metal-organic precursors from Strem Chemicals (trimethylaluminum [98%], diethylzinc [95%], or titanium tetrachloride [97%]) were dosed from room temperature for 1 second (~300 mTorr) unless otherwise noted (Figure 1). The PIM-1 material within the chamber was exposed to the static precursor environment for varying amounts of time (5 hours, unless otherwise noted) to allow the precursor to sorb and diffuse (Figure 1). After the prescribed time, the chamber was purged and evacuated (Figure 1). Room temperature deionized water vapor (e.g., an oxidant) was then dosed for 5 seconds (~1.5 Torr) and exposed to the PIM-1 material for a time equivalent to precursor exposure to allow the water to sorb and diffuse (Figure 1). The chamber was purged and evacuated before repeating the cycle (two total cycles were used unless otherwise noted) (Figure 1). Materials were removed promptly once the process was completed. VPI recipes were automated via custom Labview control software (Piercy et al. *Mater. Process. Meas. Phenom.* 2015, 33, 043201).

Figure 2 is an illustration of conducting VPI in a hollow fiber membrane module. All ports of a typical membrane module were temporally connected to a rough vacuum pump, a metal-organic precursor container, and a water container. The temperature of all tubes and modules was maintained by heating pads or a water bath. By switching the valves, membranes in the module can be evacuated (open valve 1 but close valve 2 and 3), infiltrated with metal-organic precursors (open valve 2 but close valve 1 and 3) or infiltrated with water vapor (open valve 3 but close valve 1 and 2). After infiltration, pumps and reactant containers can be disassembled. The module containing hybrid membranes can then be integrated into separation processes.

Figure 3, Figure 4, Figure 5, and Figure 6 illustrate how the VPI process creates metal oxide / PIM-1 hybrid membranes. Pristine PIM-1 membranes (e.g., thin composite films, hollow fiber membranes, or free-standing membranes) were fabricated and then placed in a customized isothermal reaction chamber maintained at 90 °C (Figure 3). After evacuation to rough vacuum (60 mTorr), the membranes were sequentially exposed to metal-organic precursors (trimethylaluminum [TMA], diethylzinc [DEZ], or titanium tetrachloride [TiCl₄]) and water vapor. During exposure, precursor molecules sorbed and diffused into the PIM-1 membranes (Figure 4). After a purge-pump cycle, the membrane, which is now saturated with metal-organic precursors, was exposed to water vapor. The

metal-organic and water reacted within the membrane creating an interpenetrating metal oxide network (Figure 5 and Figure 6).

By varying the exposure times and the number of cycles in VPI, the amount and depth of inorganic infiltration can be engineered (Figure 7-Figure 9). The loading of metal atoms reaches the maximum on the edges of the membrane and decreases into the center of the membrane due to diffusion limitations (Figure 7 and Figure 8). Longer hold time can increase the infiltration depth (Figure 9). Metal oxide loading amounts and depths also depend on membrane morphology. Dense membranes with low free volume have large characteristic mass transfer lengths and require long diffusion times to achieve full infiltration. Since it is challenging to fully infiltrate dense thick PIM-1 membranes in reasonable timeframes, membranes with a thin PIM-1 selective layer (e.g., thin film composite [TFC] and hollow fiber membranes) are used in the following experiments to ensure thorough infiltration of the metal oxide.

Cross-section Scanning Electron Microscopy (SEM) images of the membranes were obtained with a Hitachi 8230 FE-SEM. Membranes were soaked in n-hexane for 10 minutes and fractured in liquid nitrogen to get clean cross sections. Crystallized hexane prevents the collapse of macropores during fracturing, and the low surface tension of hexane avoids the collapse of macropores and mesopores during evaporation. Fractured membranes were also sputtered with gold to reduce electron charging. Energy-dispersive X-ray (EDX) spectroscopy was used to obtain the element mapping of the membranes.

Transmission Electron Microscopy (TEM) was used to determine the homogeneity of the hybrid material. TEM grids with carbon lace were dip-coated in a 0.5 wt% PIM-1 chloroform solution and dried in a glove bag filled with nitrogen. After 24-hour slow evaporation, the PIM-1 coated grids were further dried in vacuum at 100°C for 24 hours. The PIM-1 coated grids were then thoroughly infiltrated with AlO_x , ZnO_x , and TiO_x (90°C, two cycles of VPI, 5-hour hold time). The microstructure of the hybrid membranes on these grids was then analyzed with a Hitachi HT7700 TEM.

The microstructure and chemical composition of pristine PIM-1 membranes and PIM-1 membranes infiltrated with aluminum oxide networks ($\text{AlO}_x/\text{PIM-1}$) were analyzed photographically and using electron microscopy. Infiltrated, hybrid membranes showed negligible change in macrostructure. At the micro-scale, the inorganic constituent was homogeneously dispersed throughout the entire polymer (Figure 10-Figure 11). Even at the nano- to atomic-scale, the inorganic constituent appeared to be homogeneously distributed:

no metal oxide nanoparticles were observed in TEM (Figure 12), and no metal oxide crystallinity is detected with XRD (Figure 13).

X-ray powder diffraction was used to analyze the crystallinity of the interpenetrating networks of metal oxide and PIM-1. PIM-1 hollow fiber membranes thoroughly infiltrated with AlO_x , ZnO_x and TiO_x (90°C, two cycles of VPI, 5-hour hold time) were ground into fine powders and then analyzed by Panalytical XPert PRO Alpha-1 XRD (Malvern Panalytical).

XRD patterns of pristine PIM-1 exhibited the characteristic peaks of PIM-1 at 13°, 18°, and 23° indicate the interlayer spacing of 6.8 Å, 4.92 Å and 3.85 Å (Figure 13). These peaks were also observed at the identical position in the XRD of $\text{ZnO}_x/\text{PIM-1}$, $\text{TiO}_x/\text{PIM-1}$, and $\text{AlO}_x/\text{PIM-1}$, which suggests that the infiltrated metal oxides do not interrupt the microporous structures of PIM-1 (Figure 13). None of the characteristic peaks corresponding to the crystal structures of metal oxides were found, which indicates that infiltrated metal oxides form amorphous structures due to confinement within PIM-1 (Figure 13). These results revealed that the PIM-1 membranes accommodated homogeneous inorganic loading without significant changes in microstructure.

X-ray Photoelectron Spectroscopy (XPS) was used to determine the existence and chemical bonding states of hybrid materials. PIM-1 hollow fiber membranes thoroughly infiltrated with AlO_x , ZnO_x and TiO_x (90°C, two cycles of VPI, 5-hour hold time) were ground into fine powders and analyzed with a Thermo K-Alpha XPS (Thermo Fisher Scientific). Since metal oxide/PIM-1 hybrids are nonconductive, electrons aggregated on the sample surface result in significant peak shifts. Peak position was calibrated via an internal standard method. For each hybrid material, two pools of sample powders were prepared, one of which was mixed with silver nanoparticles. C^{1s} peak position was firstly calibrated according to the Ag^{3d} peaks detected in the sample mixed with silver nanoparticles. The other peaks in the sample without additives was then calibrated according to the C^{1s} peak shifts. Metal oxides were also coated onto silicon wafers via atomic layer deposition and analyzed by XPS. O^{1s} peak positions of metal oxides were used as a comparison.

Solid-state NMR was used to identify chemical states of carbon, hydrogen and aluminum atoms in the hybrid materials. PIM-1 hollow fiber membranes thoroughly infiltrated with AlO_x , ZnO_x and TiO_x (90°C, two cycles of VPI, 5-hour hold time) were

ground into fine powders and packed into the zirconium NMR rotor. Solid-state NMR was then carried out via Bruker Avance III 400.

Fourier-transform infrared spectroscopy (FTIR) was used to characterize changes in the vibrational spectrum of PIM-1's functional groups after VPI. 10- μm flat PIM-1 films were thoroughly infiltrated with AlO_x , ZnO_x and TiO_x (90°C, two cycles of VPI, 5-hour holds) and characterized with a Thermo Scientific iS50 FT-IR Spectrometer (Thermo Fisher Scientific) using transmission mode.

Chemical characterization indicated that the PIM-1 backbone remains unchanged after infiltration with various metal oxides. XPS results (Figure 14) showed negligible changes in the binding energy of PIM-1's nitrogen and oxygen—the atoms most likely to react with the metal-organic precursors. The formation of unbound metal oxides was apparent in the O^{1s} spectra (Figure 14, 530.9 eV, 530.5 eV and 529.7 eV for AlO_x , ZnO_x , and TiO_x) and the corresponding metal atom spectra (Figure 15-Figure 18). These results were mirrored in solid-state ^{13}C NMR, solid-state ^1H NMR (Figure 19-Figure 20), and FTIR (Figure 21) in that no shifts in peak locations or intensities occurred for the polymer's structure. In total, these results imply that metal oxide clusters percolated throughout the hybrid structure but did not chemically bond to the PIM-1 polymer.

It was hypothesized that during VPI, metal-organic precursors formed semi-permanent adducts with the PIM-1's nitrile groups (Figure 22), similar to the interaction previously observed between TMA and amine or nitro functional groups in other VPI processes (Jue et al. *Macromolecules* 2015, 48, 5780–5790). Coordination of aluminum in the proposed VPI mechanism shown in Figure 22 was based on solid-state ^{27}Al NMR (Figure 23). Experiments with long-duration purging between precursor exposure and water dose (Figure 24) further supported the formation of these semi-permanent adducts as no loss in metal oxide loading was observed. Upon water exposure, the metal-organic was oxidized, the adduct released, and the inorganic became unbound metal oxide clusters (Figure 22). Further condensation reactions and repeated VPI cycling interconnected these metal oxide clusters into an inorganic network (Figure 22). This metal oxide network was detected by burning out the PIM-1 skeleton of the hybrid membrane and probing the residual microporous metal oxide structure via cryogenic N_2 physisorption (Figure 25-Figure 29).

To investigate the influence of different VPI parameters on the resulting hybrid materials, PIM-1 hollow fiber membranes were infiltrated with different metal oxides, for different hold times, and different VPI cycle numbers. Owing to the hierarchical porosity of

hollow fiber membranes, the effect of diffusion rate and infiltration depth can be neglected. Weight loading of metal oxides in PIM-1 membranes was determined by TGA Q500 (TA Instruments). Hollow fiber membranes were placed in platinum sample pans and heated in flowing air. During each thermal gravimetric analysis, the temperature was first maintained at 110°C for 1 hour to get rid of trapped moisture. After this *in situ* drying process, temperature was ramped to 900°C at 10°C /min. PIM-1 hollow fiber membranes treated with methanol and infiltrated with AlO_x (2-cycle VPI at 90°C with 5-hour hold time) were transformed into porous alumina hollow fibers (Figure 25-Figure 27) as byproducts of thermogravimetric analysis.

10 Nitrogen physisorption was conducted at 77 K using a BELSORP-max (MicrotracBEL). PIM-1 hollow fiber membranes infiltrated with metal oxides were ground into fine powders and then dried under vacuum at 110°C for 12 hours. BET surface areas were calculated from the low-pressure region ($p/p^{\text{sat}} < 0.3$) of the cryogenic nitrogen physisorption isotherm. Pore size distribution was calculated via a N₂ DFT model.

15 To optimize hybrid membrane performance, the amount of metal oxide loading must be controlled to balance the trade-off between chemical stability and loss of porosity. The amount of metal oxide loading was quantified with thermogravimetric analysis (TGA) and the microporosity was measured via N₂ physisorption. Results are presented in Figure 30-Figure 32 and were collected from PIM-1 hollow fiber membranes infiltrated with three
20 different metal-organic precursors: trimethyl aluminum (TMA), diethylzinc (DEZ), and titanium tetrachloride (TiCl₄). These data show that VPI chemistry and processing conditions affected the amount of metal oxide loading. The AlO_x/PIM-1 hybrid membrane showed significantly higher metal oxide loading than the other chemistries, yet exhibited nearly identical internal surface area, with only a 18% drop in surface area compared to neat
25 PIM-1 (Figure 30).

Infiltrated metal oxide significantly reduces the size of micropores created by PIM-1 backbones (Figure 33). Higher metal oxide loading results in a further reduction of pore sizes (Figure 33). To determine how the entanglement of metal oxides with PIM-1 molecules influenced membrane swelling, cryogenic nitrogen sorption isotherms were
30 created. In the resulting curves (Figure 32), pristine PIM-1 hollow fiber membranes show their typical dual-mode sorption behavior: Langmuir-type (flat) sorption behavior in the low pressure region due to nitrogen physisorption into micropores and Henry-type (linear) behavior at higher pressures ($p/p^{\text{sat}} > 0.2$) associated with nitrogen induced swelling.

Importantly, the hybrid membranes still possess the characteristically high initial nitrogen uptake of pristine PIM-1 membranes. The high initial sorption behavior of PIM-1 is just one of many attributes that make it an attractive membrane material. Additionally, hybrid PIM-1 membranes all exhibit a reduction in swelling and a more ideal (flat) Langmuir sorption behavior. The degree of swelling reduction is consistent with the metal oxide loading. AlO_x/PIM-1 hybrid membranes pre-treated with methanol have the highest metal oxide loadings and accordingly show nearly ideal (flat) Langmuir sorption (until $p/p^{\text{sat}} > 0.8$).

Generally, longer VPI exposure times or more VPI cycles increased metal oxide loading, deepened metal oxide penetration, and decreased BET surface area (Figure 31, Figure 32, Figure 7, Figure 9). Pretreatment of PIM-1 with methanol, which can reverse PIM-1's aging and increase free volume (Jue et al. *Macromolecules* 2015, 48, 5780–5790; Budd et al. *J. Memb. Sci.* 2008, 325, 851–860), also increased metal oxide loading (Figure 34). The interpenetrating metal oxide networks inhibited the swelling induced by guest molecules (Figure 35 and Figure 36) and resulted in more Langmuir-type N₂ isotherms as metal oxide loading increased (Figure 32, Figure 33).

Toluene and water isotherms were measured using Dynamic Vapor Sorption system (DVS Vacuum, Surface Measurement Systems) to investigate the influence of interpenetrating metal oxide networks on the interaction between toluene/water and PIM-1 membranes. PIM-1 hollow fiber membranes with and without VPI treatment were placed and in situ dried at 110°C in the sample chamber of DVS. The samples were then exposed toluene or water vapor of certain pressure at 25°C. Equilibrium criteria was set to less than 0.001 wt% change within 10 min. Each isotherm was determined for at least 3 times to calculate the standard deviation.

A reduction in swelling is observed in the toluene adsorption isotherms measured at 25 °C (Figure 35). The toluene isotherms can be well fitted by dual-mode sorption equations, which is a combination of Langmuir-type adsorption and Henry-type sorption. By comparing the change in the contribution of Henry-type sorption, it was found that the toluene-induced swelling in AlO_x/PIM-1 was reduced by 39%. These trends revealed that the interpenetrating metal oxide networks protect PIM-1 membranes from swelling while preserving their vital membrane characteristics.

The hybrid membranes also exhibited a change in hydrophilicity, which could open new pathways for aqueous separations (Figure 36, Figure 37). While pristine PIM-1 is hydrophobic, the metal-oxide-infiltrated PIM-1 hollow fiber membranes show significantly

higher water uptake (Figure 36). This increase in water molecule affinity results from additional adsorption sites provided by the interpenetrating metal oxide networks (Figure 36). The increase in hydrophilicity for ZnO_x and AlO_x/PIM-1 membranes is further supported by contact angle measurements (Figure 37). Contact angle measurements were
5 conducted on a Ramé-Hart Model 250 Goniometer/Tensiometer using drop size volumes of 10 microliters. Measurements and photos were taken 5 minutes after dispensing. TiO_x membranes, however, exhibit a more hydrophobic contact angle (Figure 37). This may be due to increases in surface roughness on the PIM-1 membranes. Generally, the more hydrophilic nature of ZnO_x and AlO_x/PIM-1 membranes may provide a pathway for the use
10 of PIM-1 based membranes in aqueous separations.

An Avantes Avaspec-2048 UV-vis spectrometer with a halogen light source was used to determine dissolution percentages of PIM-1 and AlO_x/PIM-1 in tetrahydrofuran over time. Short term experiments (up to several hours) were conducted where a treated or untreated hollow fiber membrane with known mass was placed directly in a cuvette with a
15 known amount of solvent. Measurements were taken automatically by the software over time. Absorption values were translated into concentrations using Beer's law and a set of reference standards. Long-term measurements (over a few hours) were conducted in vials containing a known mass of hollow fiber membrane and known volume of THF. Aliquots were taken from these vials and diluted prior to measurement with UV-Vis to ensure
20 absorption values in the range of Beer's law. For AlO_x/PIM-1 membranes, TGA results were used to calculate the mass of the membrane due to PIM-1. This mass was used to calculate percent dissolved.

Concurrent with an increase in metal oxide loading was an improvement in solvent resistance. When tested against strong solvents for PIM-1 (tetrahydrofuran [THF],
25 dichloromethane [DCM], and chloroform [CHCl₃])—all of which dissolve PIM-1 within minutes) all hybrid membranes showed improved stability, many remaining stable throughout 3 months of testing. Among the hybrid membranes studied here, AlO_x/PIM-1 membranes exhibited the highest solvent stability. Figure 38 illustrates this stability in THF. While PIM-1 membranes fully dissolve within one day, AlO_x/PIM-1 hybrid membranes
30 lose only 10% of their weight after 1 month of immersion in THF (Figure 38).

Based on this evaluation of physical properties, 2 VPI cycles of TMA-H₂O with 5-hour holds and a methanol pretreatment was determined to achieve the best trade-off between retaining microporosity and imparting chemical stability for the systems tested

herein. This VPI treatment was then applied to PIM-1 hollow fiber membranes and thin film PIM-1 membranes supported by cross-linked Torlon® for organic solvent nanofiltration performance testing. To increase infiltration of thin film composite PIM-1 membranes, a 3 second precursor dose time was used.

5 Torlon™ support membranes were fabricated via nonsolvent induced phase inversion. Torlon™, tetrahydrofuran, ethanol and N-Methyl-2-pyrrolidone were mixed with a mass ratio of 20:14:10:56 in a sealed container. Once the polymer was fully dissolved, the homogeneous solution was then cast into a liquid film via a blade on a clean glass plate. The liquid film was then transferred to a well-ventilated hood to assist the formation of a partial
10 skin layer. After 1 minute, the liquid film was immersed into a deionized water bath. Phase inversion completes within 1 hour resulting in an opaque porous Torlon™ membrane. The membrane was then stored in a new water bath for 12 hours, followed by three washing cycles in methanol and three washing cycles in n-hexane sequentially. During each washing step, the membrane was immersed in the solvent bath for 3 hours. After vacuum drying at
15 200 °C for 12 hours, these Torlon™ support membranes were stored in the ambient environment before cross-linking.

These Torlon™ membranes were crosslinked by p-xylylenediamine. Dry Torlon™ membranes were immersed in 10 wt% p-xylylenediamine methanol solution for 24 hours at room temperature. After cross-linking, the membranes were washed with methanol and n-
20 hexane three times respectively. After vacuum drying at 100°C for 12 hours, these cross-linked Torlon™ support membranes were stored in the ambient environment before spin coating.

PIM-1 thin films were coated onto these cross-linked Torlon™ support membranes via spin coating. 1 wt% PIM-1 in chloroform was dropped onto the cross-linked Torlon®
25 support membranes and spun at 500 rpm for 10 min. During the spin coating process, the membrane processing chamber was saturated with chloroform vapor to slow the drying process. After spin coating, the resulting PIM-1 thin film composite membranes were dried under vacuum at 100 °C for 24 hours.

Organic solvent nanofiltration was conducted in a cross-flow permeation system
30 (Figure 39). A HPLC pump delivers pressurized mixture solution into the feed side of the membrane cell. The feed solution contact with the membrane and then flow through the backpressure regulator into the mixture container. Permeate is directed by a three-way valve into the mixture container or a sampling vial. Feed solution circulates inside the feed-side

chamber of the membrane cell, disturbing the boundary layer near the membrane. Although a flat membrane cell is illustrated here, hollow fiber membrane modules can also be tested in this setup.

For the organic solvent nanofiltration tests, feed solution flowrate was set to at least ten times that of the permeation rate. Trans-membrane pressure was maintained at 10 bar for thin film composite membranes and 10 psi for hollow fiber membranes (pristine PIM-1 hollow fiber membranes cannot withstand higher pressure when exposed to ethanol). Permeates were collected in glass sample vials. The Thermo Evolution 220 UV-vis system (Thermo Fisher Scientific) was used to determine the dye rejection, and an Agilent 1200 High Performance Liquid Chromatography (HPLC) was used to determine the polystyrene oligomer rejection.

The organic solvent nanofiltration (OSN) separation performance of these solvent-resistant hybrid membranes was quantified using cross flow permeation experiments (Figure 39) with dye molecules (Figure 40, Figure 41) or polystyrene oligomers (Figure 42, Figure 43) as solutes and ethanol or heptane as solvents. Figure 43 and Figure 44 plot the permeance of the hybrid membranes versus neat PIM-1 films for ethanol and n-heptane solvents. The hybrid membranes showed lower permeance than the most advanced thin film PIM-1 membranes but all solvent flows were more than sufficient for chemical separations and future hybrid membrane designs can further optimize the selective layer thickness to offset for this loss in permeance (Cook et al. *J. Memb. Sci.* 2018, 558, 52–63; Gorgojo et al. *Adv. Funct. Mater.* 2014, 24, 4729–4737). When separating dye molecules (Rose Bengal) in ethanol, the hybrid membranes rejected twice as much dye as neat PIM-1 membranes (86% versus 43%, Figure 40, Figure 41). This result suggests that the interpenetrating AIO_x networks within these hybrid membranes interrupted the strong interaction between dye molecules and the membrane, reducing dye permeation through the hybrid membranes. The VPI modification provided sufficient stabilization and resistance to swelling to enable the rejection of strongly sorptive solutes, which are typically challenging for polymer-based membranes to remove.

Figure 42 plots polystyrene oligomer retention as a function of molecular weight in n-heptane and ethanol. This data illustrates the size-based molecule separation performance of the membranes in various solvents. For the thin untreated PIM-1 composite membrane, the 80% molecular weight cut-off (MWCO; the smallest molecular weight the membrane “successfully” rejects) was about 600 g/mol in n-heptane, a solvent that does not

significantly swell or plasticize PIM-1. However, in ethanol, a solvent that does significantly swell and plasticize PIM-1, the 80% molecular weight cut-off increased to more than 1200 g/mol. This loss of size-based separation performance for PIM-1 in solvents that plasticize the polymer is consistent with other experiments in the literature (Cook et al. *J. Memb. Sci.* 2018, 558, 52–63). In contrast, hybrid AlO_x/PIM-1 membranes showed improved polystyrene rejection in both n-heptane and ethanol solvents (Figure 42). AlO_x/PIM-1 in n-heptane showed overall higher rejection (above 90%) than neat PIM-1 and has a 90% molecular weight cut-off of 400 g/mol. This decrease in molecular weight cut-off was expected based on the results that the infiltrated AlO_x not only reduced the micropore size within the membrane but also inhibited solvent-induced swelling (Figure 33, Figure 35). When the separation was conducted in ethanol, AlO_x/PIM-1 showed identical separation behavior as in n-heptane (Figure 42). These results show that these hybrid membranes have outstanding size-based separation performance in plasticizing solvents when compared to prior reports of solution-processable microporous polymer membranes (Cook et al. *J. Memb. Sci.* 2018, 558, 52–63; Fritsch et al. *J. Memb. Sci.* 2012, 401–402, 222–231).

In summary, vapor phase infiltration can be used to create unbound but interpenetrating atomic-scale metal oxide networks within microporous polymer membranes like PIM-1. Unlike pure polymer membranes, these organic-inorganic hybrid membranes strongly resisted swelling and dissolution in aggressive solvent environments. With this added chemical stability, hybrid PIM-1 membranes not only outperformed untreated PIM-1 membranes for chemical separations in standard environments but also provided consistent performance in environments that would swell or dissolve the neat polymer.

The VPI process is low-temperature and solvent-free and can be conducted inside pre-formed membrane modules of any arbitrary form factor, thus simplifying manufacturing scale-up. Further, the VPI processing can be easily integrated with state-of-the-art membrane modules, suggesting that this treatment can be readily adopted into the large-scale manufacturing of advanced membranes. The methods described herein can establish a scalable, solvent-free, post-synthesis treatment for transforming microporous polymers into hybrid membranes that can supplant energy intensive distillation processes for chemical separations.

Example 2

Polymer of intrinsic microporosity 1 (PIM-1) is a polymer whose contorted shape and rigid backbone result in materials with high levels of free volume or “microporosity” (Figure 45 and Figure 46). This free volume has shown utility in a variety of applications (e.g., sensing, separations, gas storage, etc.). PIM-1 can be dissolved in various solvents and solution-processed into different shapes for targeted applications (e.g., wovens, fibers, etc.). The combination of microporosity and solution-processability makes PIM-1 an ideal material for applications like absorption, membrane separation, etc. However, when exposed to organic solvents or vapors, due to its solution-processability, PIM-1 experiences rapid aging, plasticization, swelling, and even dissolution. Thus, there is a need for a post synthesis process that stabilizes PIM-1 without compromising porosity.

Vapor phase infiltration is a process by which inorganic materials sorb, diffuse, and become entrapped within organic materials (Figure 4 and Figure 47): sorption comprises the dissolution of gaseous metalorganic precursor into the polymer; diffusion comprises migration of the sorbed precursor within the polymer; and entrapment comprises immobilization of the precursor through reaction or steric hinderance.

Described herein are highly stable organic-inorganic hybrid PIM-1 materials with chemical resistance made using vapor phase infiltration (VPI). During the vapor phase infiltration process, PIM-1 absorbs and traps inorganic material. The inorganic materials form networks throughout the PIM-1 and offer solvent resistance as well as potentially reducing the aging time by coating and “propping open” the micropores. This treatment does not significantly inhibit the mechanical properties of PIM-1, but it does increase the long-term stability and chemical durability. Infiltrated PIM materials can withstand concentrated solvents (e.g., tetrahydrofuran, chloroform, dichloromethane) for over a month, while the non-infiltrated PIMs dissolve within minutes. Because VPI can be used to infiltrate PIM-1 with different inorganic materials, new functionalities like catalysis are also possible.

The precursors used for the infiltration of PIM-1 were diethylzinc (DEZ), trimethyl aluminum (TMA), and titanium tetrachloride (TiCl₄). The hold times for the VPI process were 15 minutes, 2 hours, and 5 hours. The VPI process was repeated for 1, 2, 3, 5, or 10 total cycles. The infiltration temperatures used were 90°C and 110°C.

The hybrid materials were characterized by SEM/EDX and XPS to confirm the form of the inorganics within PIM-1 and by BET Surface Area and Pore Size Distribution

Analysis to investigate the effect of infiltration on microporosity. EDX analysis of an infiltrated PIM-1 sample showed that some level of infiltration was achieved throughout the entire sample (Figure 48 and Figure 49).

5 Infiltration of PIM-1 at 90°C with 300 minute holds and 2 cycles with precursors of DEZ, TMA and TiCl₄ showed that, with similar cycle numbers and hold times, all three precursor chemistries resulted in greater than 6 wt% loading of the metal oxide (Figure 50).

Infiltration of PIM-1 with TMA and H₂O at 90°C with various cycle numbers and hold times showed that both hold times and the number of cycles can play a significant role in the amount of metal oxide loaded in the hybrid material (Figure 51).

10 The VPI parameters were also used to modify the hydrophilicity of PIM-1 (Figure 52 and Figure 53).

The effect of ethanol on a hybrid PIM-1 material was tested. First, ~100 nm PIM-1 films were prepared by spin coating a PIM-1/THF solution on silicon wafers. The PIM-1 films were then infiltrated in a VPI chamber under a variety of conditions (e.g., chemistry, reactor temperature, precursor hold times, and number of cycles were varied). The initial infiltrated film thickness was measured with an ellipsometer. The thickness of the films was then monitored over time via an ellipsometer upon exposure to ethanol to measure the effect of ethanol on the thickness of the membranes. The films were immersed in ethanol for 10 minutes, removed, air dried for 30 seconds, and then the thickness was measured with the
15 ellipsometer. The prevention of swelling upon exposure to ethanol varied with infiltrant chemistry and number of cycles (Figure 54).

The VPI parameters can be used to balance the metal oxide loading with the effect on BET surface area of the hybrid samples (Figure 55).

The hybridized PIM-1 materials showed excellent solvent resistance and withstood
25 immersion in THF (a strong solvent for PIM-1) for over a week (Figure 56-Figure 60). The vapor phase infiltration process can be optimized to balance decreases in pore size distribution with solvent/chemical resistance.

Herein, vapor phase infiltration of polymers was shown to create stable hybrid organic/inorganic materials with chemical resistance. By varying infiltration parameters, the materials were either fully or partially hybridized, thus expanding the application space of
30 these materials. The VPI treatments did not significantly inhibit the typical characteristics of the polymer being infiltrated and therefore provided newfound stability with the maintenance of important properties. Infiltrated polymers were seen to withstand

concentrated solvents for over a week whereas their non-infiltrated counterparts dissolve in minutes. These hybrid materials can also have increased resistance to aging and provide opportunities for tunable selectivity in fluid separations. These hybrid materials would be able to extend the applications of PIM-1 to new types of streams that deleteriously affect
5 PIM-1. These materials could replace the expensive and energy intensive distillation columns currently in use in industry or be utilized as sensors of storage devices. Additionally, tunable guest interactions could be used to optimize PIM-1 for specific applications. The hybrid materials can be imbued with additional properties by further modifying the hybrid materials with other infiltrants (e.g., antimicrobial, fluorescence,
10 hydrophilicity, etc.). Potential applications of the hybrid membranes include, for example, gas storage devices, sorbents, catalysis, sensors, separations.

Other advantages which are obvious and which are inherent to the invention will be evident to one skilled in the art. It will be understood that certain features and sub-
15 combinations are of utility and may be employed without reference to other features and sub-combinations. This is contemplated by and is within the scope of the claims. Since many possible embodiments may be made of the invention without departing from the scope thereof, it is to be understood that all matter herein set forth or shown in the accompanying drawings is to be interpreted as illustrative and not in a limiting sense.

20 The methods of the appended claims are not limited in scope by the specific methods described herein, which are intended as illustrations of a few aspects of the claims and any methods that are functionally equivalent are intended to fall within the scope of the claims. Various modifications of the methods in addition to those shown and described herein are intended to fall within the scope of the appended claims. Further, while only
25 certain representative method steps disclosed herein are specifically described, other combinations of the method steps also are intended to fall within the scope of the appended claims, even if not specifically recited. Thus, a combination of steps, elements, components, or constituents may be explicitly mentioned herein or less, however, other combinations of steps, elements, components, and constituents are included, even though not explicitly
30 stated.

CLAIMS

What is claimed is:

1. A hybrid membrane comprising:
 - a microporous polymer, the microporous polymer comprising a continuous polymer phase permeated by a continuous pore phase; and
 - an atomic scale inorganic material dispersed throughout the microporous polymer within the continuous pore phase, wherein the inorganic material comprises a metal oxide, a metal nitride, a metal carbide, a metal oxynitride, a metal oxycarbide, a metalloid oxide, a metalloid nitride, a metalloid carbide, a metalloid oxynitride, a metalloid oxycarbide, or a combination thereof.
2. The hybrid membrane of claim 1, wherein the microporous polymer comprises a polymer of intrinsic microporosity (PIM), a hypercrosslinked microporous polymer (HCP), a covalent organic framework (COF), a conjugated microporous polymer (CMP), a porous aromatic framework (PAF), a porous organic cage (POC), derivatives thereof, or combinations thereof.
3. The hybrid membrane of claim 1 or claim 2, wherein the microporous polymer comprises a polymer of intrinsic microporosity (PIM).
4. The hybrid membrane of claim 3, wherein the polymer of intrinsic microporosity comprises PIM-1, PIM-2, PIM-3, PIM-4, PIM-5, PIM-6, PIM-7, PIM-8, PIM-9, PIM-10, KAUST-PI-1, KAUST PI-2, derivatives thereof, or combinations thereof.
5. The hybrid membrane of claim 3 or claim 4, wherein the polymer of intrinsic microporosity comprises PIM-1.
6. The hybrid membrane of any one of claims 1-5, wherein the inorganic material comprises a metal selected from the group consisting of Mg, Al, Ca, Sc, Ti, V, Cr, Mn, Fe, Co, Ni, Cu, Zn, Ga, Sr, Y, Zr, Nb, Mo, Tc, Ru, Rh, Pd, Ag, Cd, In, Sn, Ba, Hf, Ta, W, Re, Os, Ir, Pt, Au, Hg, Tl, Pb, Bi, La, Ce, Pr, Nd, Pm, Sm, Eu, Gd, Tb, Dy, Ho, Er, Tm, Yb, and combinations thereof.
7. The hybrid membrane of any one of claims 1-6, wherein the inorganic material comprises a metalloid selected from the group consisting of Si, Ge, As, Sb, Te, and

combinations thereof.

8. The hybrid membrane of any one of claims 1-7, wherein the inorganic material comprises a metal oxide, a metalloid oxide, or a combination thereof.
9. The hybrid membrane of any one of claims 1-8, wherein the inorganic material comprises a metal or a metalloid selected from the group consisting of Al, Zn, Ti, Si, Hf, Zr, Ta, Y, and combinations thereof.
10. The hybrid membrane of any one of claims 1-9, wherein the inorganic material comprises ZnO, Al₂O₃, TiO₂, SiO₂, HfO₂, ZrO₂, Ta₂O₅, Y₂O₃, Ir₂O₃, RuO₂, WO₃, Ni₂O₃, or a combination thereof.
11. The hybrid membrane of any one of claims 1-10, wherein the inorganic material is dispersed substantially homogeneously throughout the hybrid membrane.
12. The hybrid membrane of any one of claims 1-11, wherein the inorganic material forms a continuous phase within the continuous pore phase.
13. The hybrid membrane of any one of claims 1-12, wherein the inorganic material is unbound to the continuous polymer phase.
14. The hybrid membrane of any one of claims 1-13, wherein the hybrid membrane comprises from 0.1 wt% to 35 wt%, from 0.1 wt% to 13 wt%, from 0.1 wt% to 10 wt%, or from 0.1 wt% to 8.5 wt% of inorganic material based on the weight of the hybrid membrane.
15. The hybrid membrane of any one of claims 1-14, wherein the hybrid membrane has a BET surface area of from 200 m²/g to 2000 m²/g, from 200 m²/g to 1400 m²/g, from 200 m²/g to 900 m²/g, or from 500 m²/g to 800 m²/g.
16. The hybrid membrane of any one of claims 1-15, wherein the hybrid membrane is more stable in a solvent than the corresponding microporous polymer in the absence of the atomic scale inorganic material.
17. The hybrid membrane of any one of claims 1-16, wherein the hybrid membrane is more stable in toluene, tetrahydrofuran, chloroform, dichloromethane, or a combination thereof

- than the corresponding microporous polymer in the absence of the atomic scale inorganic material.
18. The hybrid membrane of any one of claims 1-17, wherein the hybrid membrane has a lower toluene uptake at a P/P^{sat} of 0.25 or more, a lower ethanol permeance, a lower n-heptane permeance, or a combination thereof than the corresponding microporous polymer in the absence of the atomic scale inorganic material.
 19. The hybrid membrane of any one of claims 1-18, wherein the hybrid membrane is stable in a solvent for 1 hour or more, 1 day or more, 1 week or more, 1 month or more, 3 months or more, 6 months or more, or 1 year or more.
 20. The hybrid membrane of any one of claims 1-19, wherein the hybrid membrane is stable in tetrahydrofuran, chloroform, dichloromethane, or a combination thereof for 1 hour or more, 1 day or more, 1 week or more, 1 month or more, 3 months or more, 6 months or more, or 1 year or more.
 21. The hybrid membrane of any one of claims 1-20, wherein the hybrid membrane comprises a film, a fiber, a free-standing membrane, a spiral wound membrane, a 3D printed membrane, or a combination thereof.
 22. The hybrid membrane of any one of claims 1-21, wherein the hybrid membrane comprises a hollow fiber.
 23. A method of making the hybrid membrane of any one of claims 1-22, the method comprising infiltrating the microporous polymer with the inorganic material using vapor phase infiltration.
 24. The method of claim 23, wherein the vapor phase infiltration comprises exposing the microporous polymer to a metal-organic precursor comprising trimethylaluminum (TMA), diethylzinc (DEZ), titanium tetrachloride (TiCl_4), or a combination thereof, thereby forming an impregnated membrane.
 25. The method of claim 24, wherein the vapor phase infiltration further comprises exposing the impregnated membrane to an oxidant comprising water, oxygen, or a combination thereof, thereby forming the inorganic material comprising a metal oxide.

26. The method of any one of claims 23-25, wherein the vapor phase infiltration is conducted at a temperature of from 0°C to 450°C, from 70°C to 250°C, from 80°C to 120°C, from 90°C to 110°C, from 85°C to 95°C, or from 105°C to 115°C.
27. The method of claim 26, wherein the vapor phase infiltration is conducted at a temperature of 90°C or 110°C.
28. The method of any one of claims 23-27, wherein the method comprises performing two or more cycles of vapor phase infiltration to make the hybrid membrane.
29. The method of any one of claims 23-28, further comprising pre-treating the microporous polymer prior to performing the vapor phase infiltration.
30. The method of claim 29, wherein pre-treating the microporous polymer comprises contacting the microporous polymer with an alcohol, dimethylfuran, n-methylpyrrolidone, or a combination thereof.
31. The method of claim 29 or claim 30, wherein pre-treating the microporous polymer comprises contacting the microporous polymer with an alcohol, the alcohol comprising methanol, ethanol, 1-propanol, 2-propanol, an isomer of butanol, an isomer of pentanol, ethylene glycol, propylene glycol, glycerol, or a combination thereof.
32. The method of claim 31, wherein the alcohol comprises methanol.
33. The method of any one of claims 23-32, wherein the hybrid membrane is formed *in situ* in a membrane module.
34. A device comprising the hybrid membrane of any one of claims 1-22, the device comprising a gas storage device, a sensor, or a combination thereof.
35. A method of use of the hybrid membrane of any one of claims 1-22, the method comprising using the hybrid membrane in a gas storage device, a sensor, or a combination thereof.
36. A method of use of the hybrid membrane any one of claims 1-22 as a sorbent, as a catalyst support, or a combination thereof.
37. A method of use of the hybrid membrane of any one of claims 1-22 in a membrane

separation.

38. The method of claim 37, wherein the hybrid membrane exhibits better separation performance than the corresponding microporous polymer in the absence of the atomic scale inorganic material.
39. The method of claim 37 or claim 38, wherein the hybrid membrane exhibits a higher rejection of a sorptive solute than the corresponding microporous polymer in the absence of the atomic scale inorganic material.
40. The method of any one of claims 37-39, wherein the hybrid membrane rejects more dye in a dye separation than the corresponding microporous polymer in the absence of the atomic scale inorganic material.
41. The method of any one of claims 37-40, wherein the hybrid membrane exhibits a better size-based separation performance in plasticizing solvents than the corresponding microporous polymer in the absence of the atomic scale inorganic material.
42. The method of any one of claims 37-41, wherein the hybrid membrane exhibits a lower molecular weight cutoff for a size-based separation than the corresponding microporous polymer in the absence of the atomic scale inorganic material.

1/30

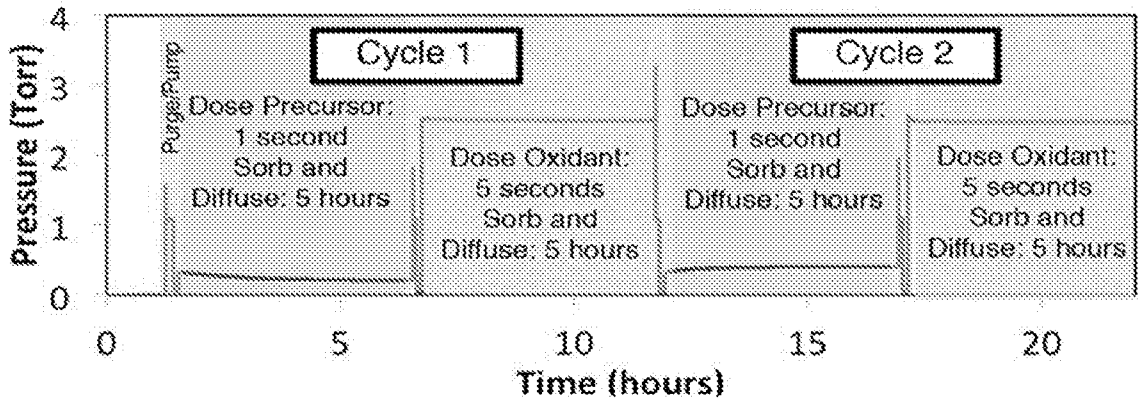

Figure 1

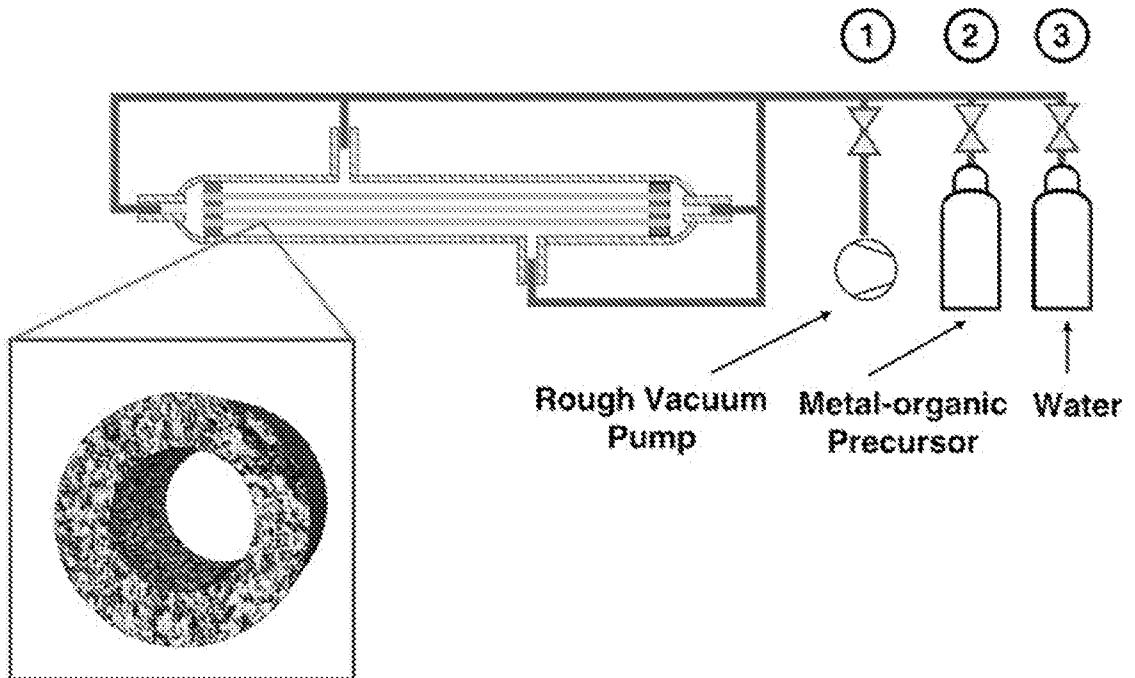

Figure 2

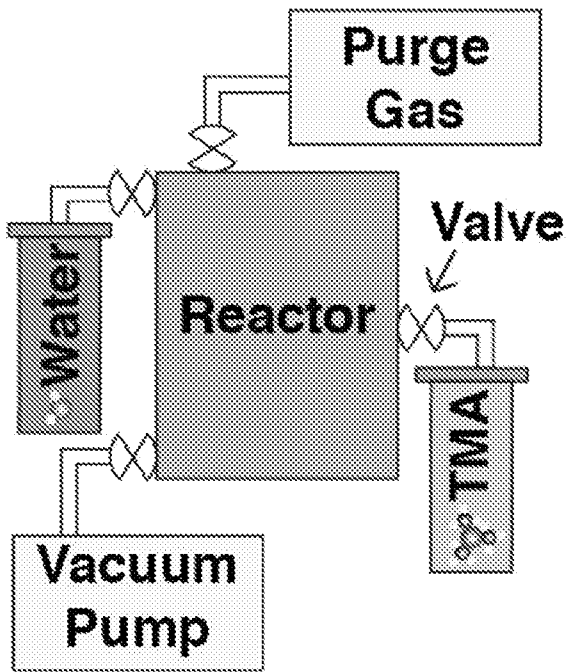

Figure 3

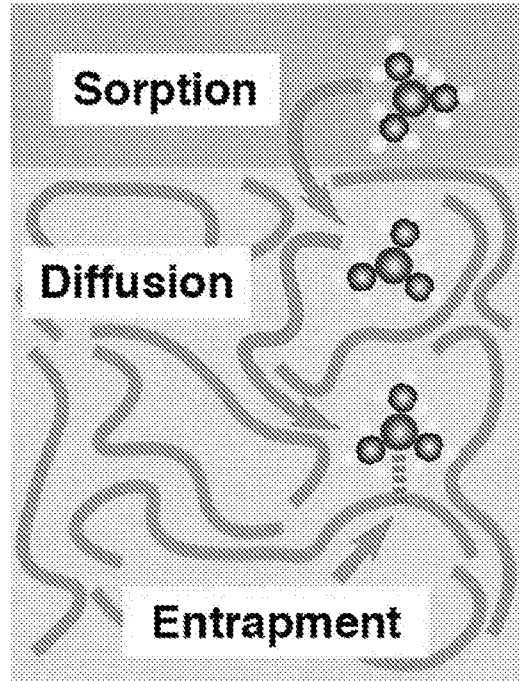

Figure 4

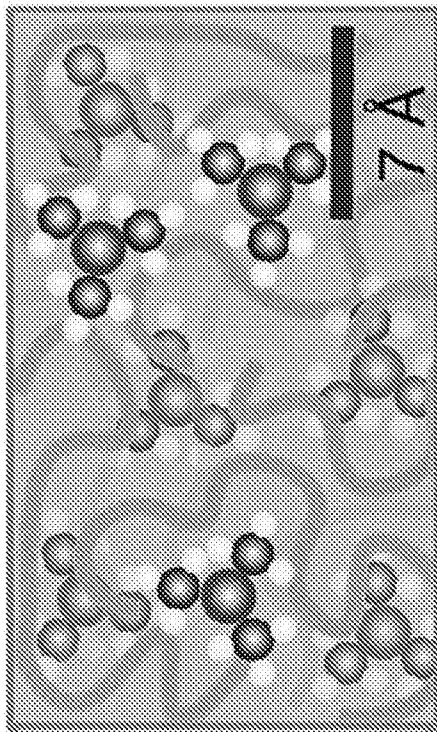

Figure 5

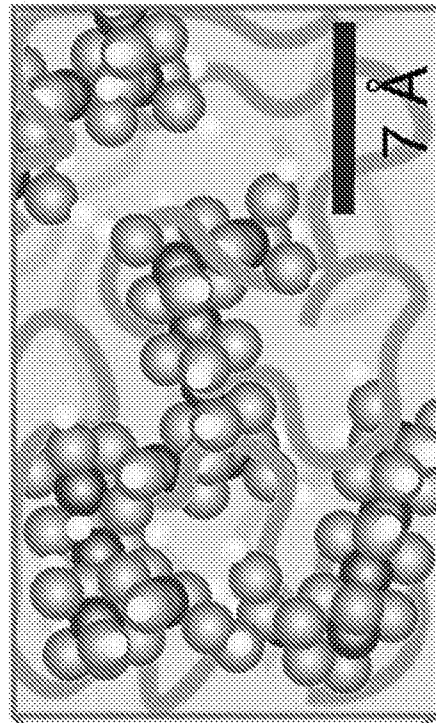

Figure 6

3/30

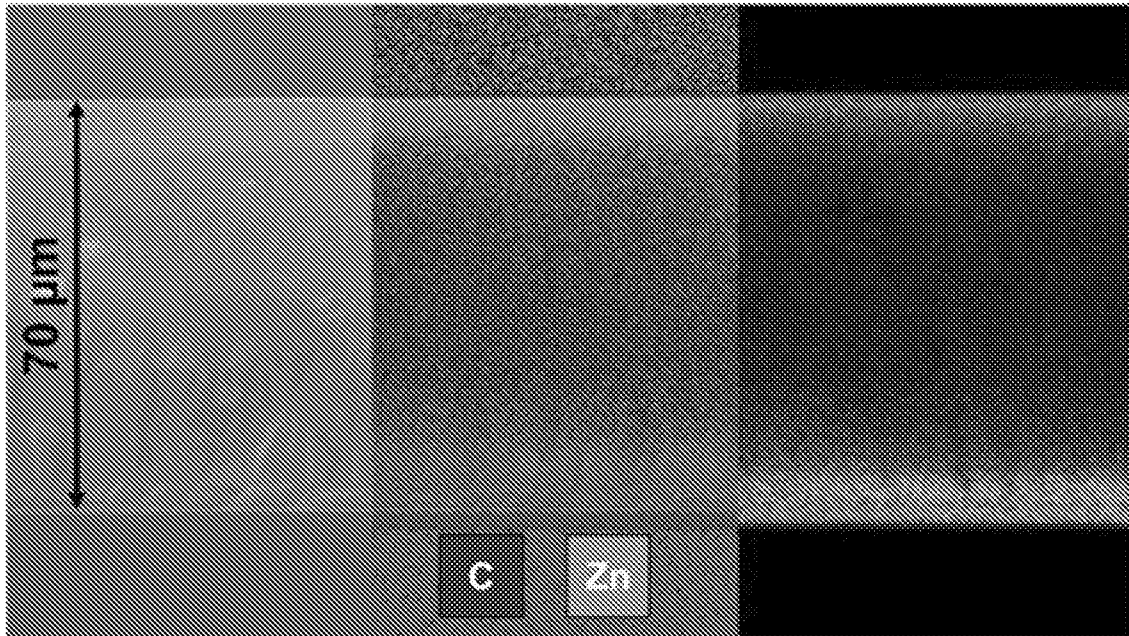

Figure 7

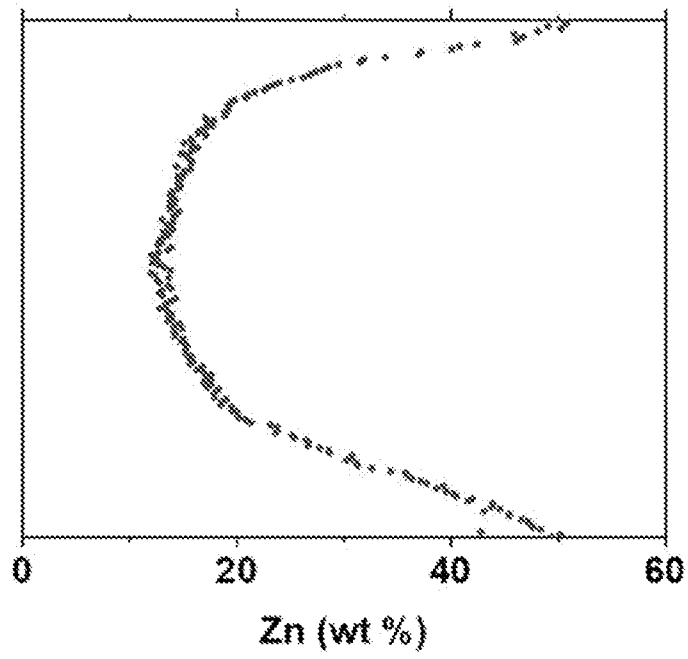

Figure 8

4/30

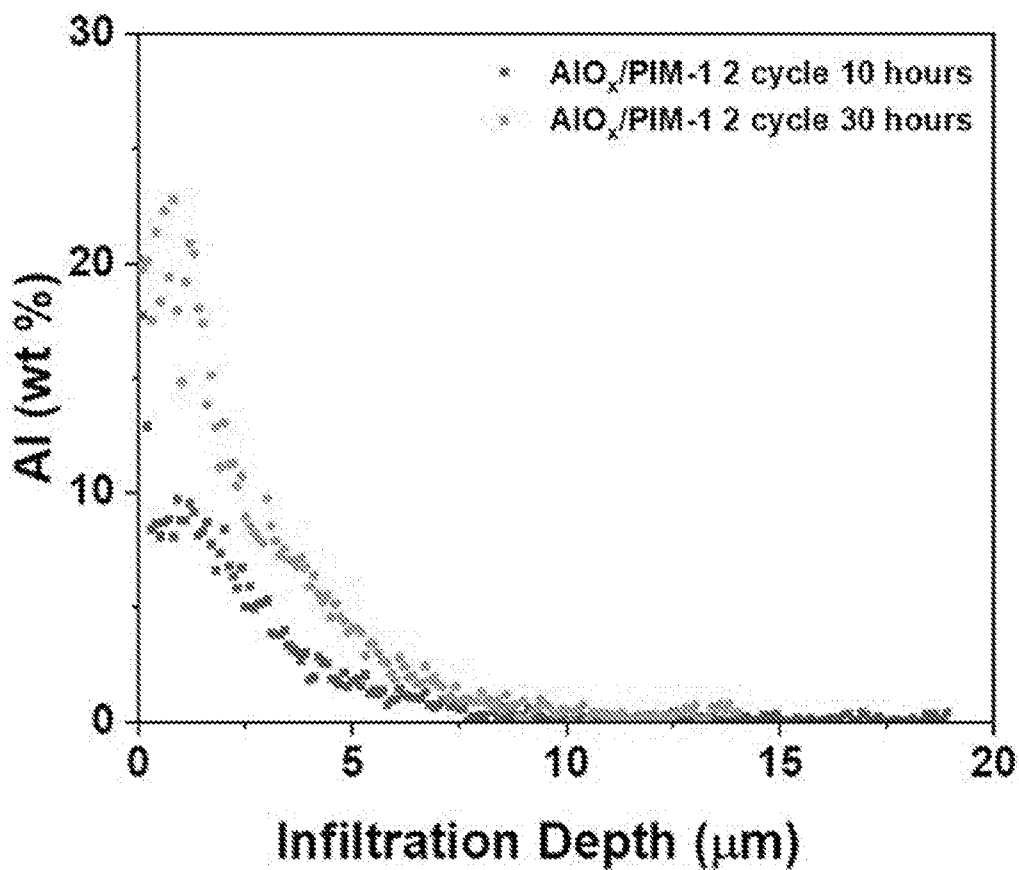

Figure 9

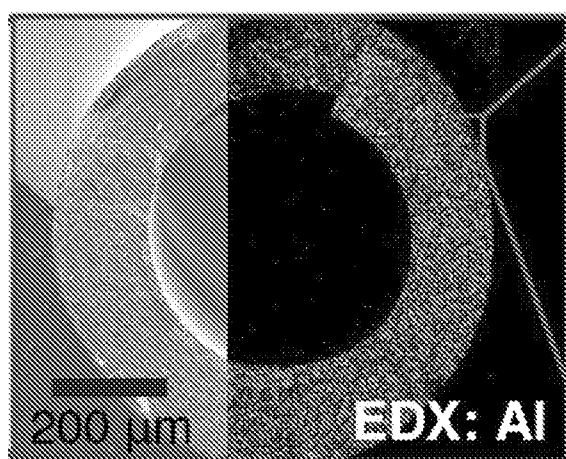

Figure 10

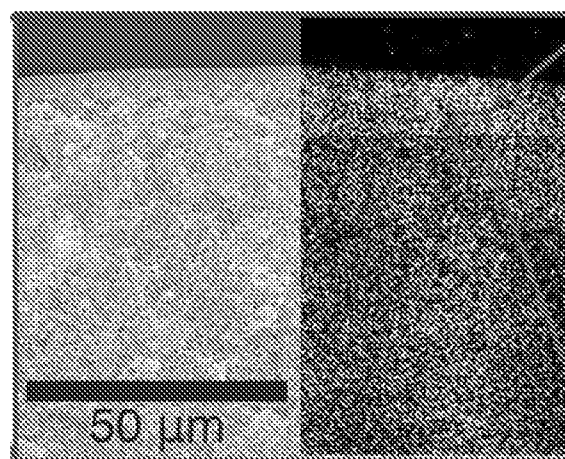

Figure 11

5/30

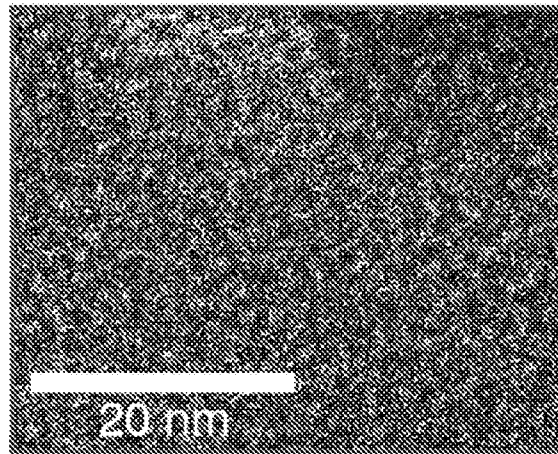

Figure 12

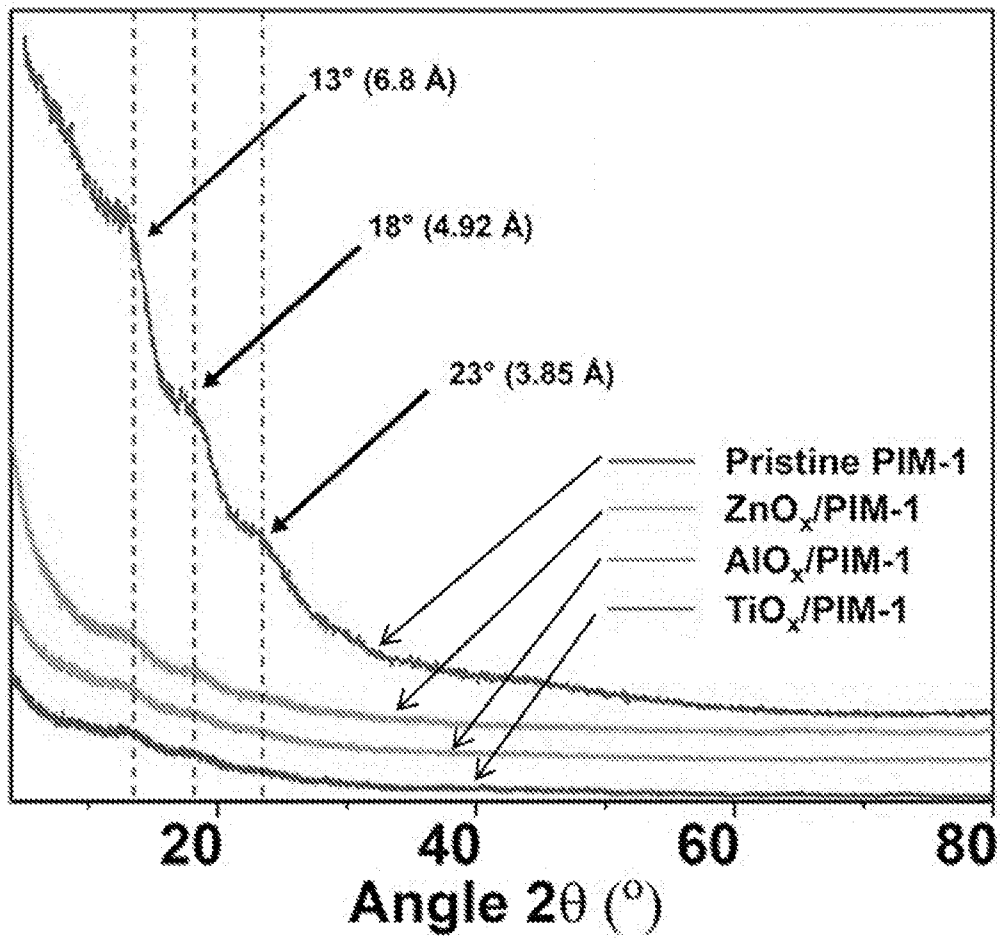

Figure 13

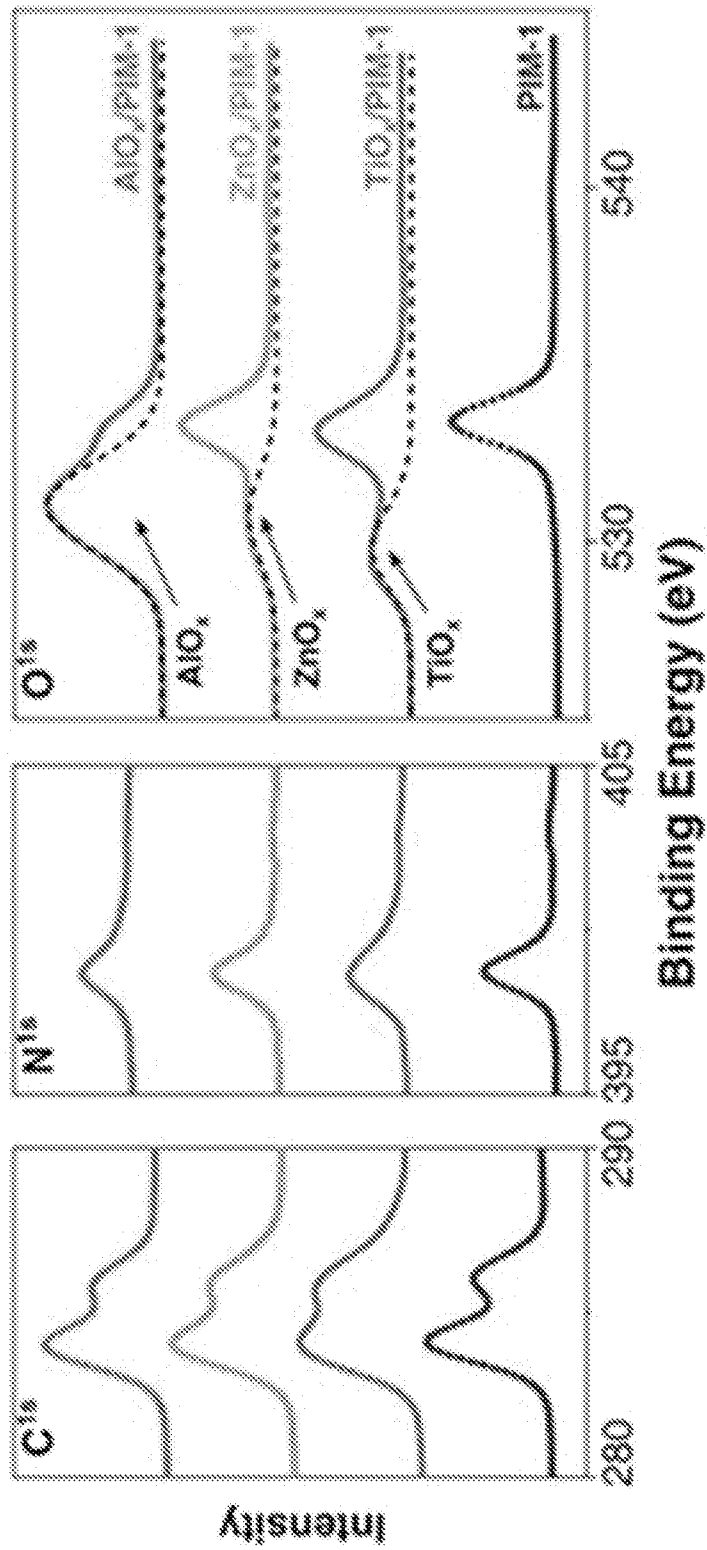

Figure 14

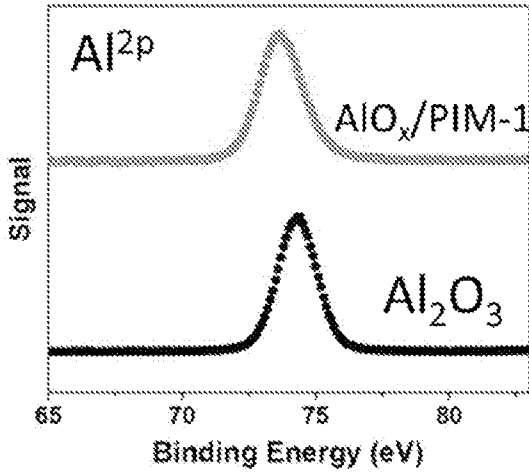

Figure 15

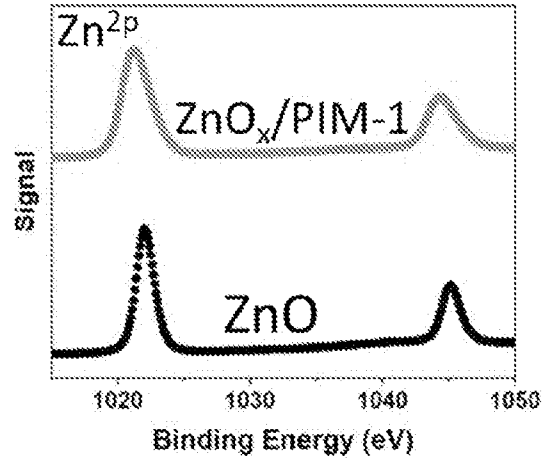

Figure 16

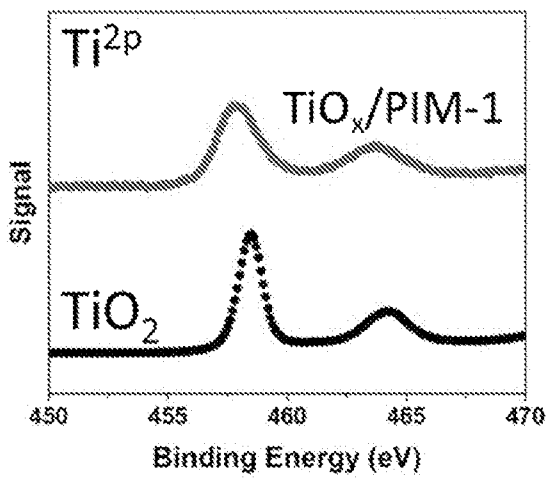

Figure 17

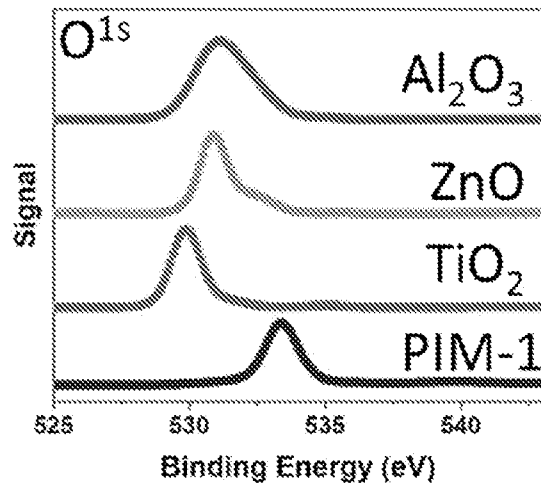

Figure 18

8/30

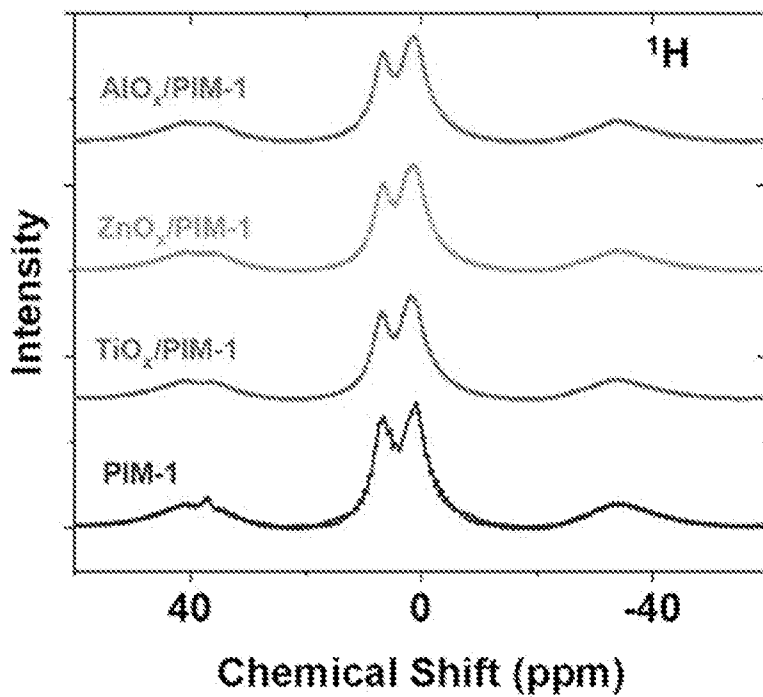

Figure 19

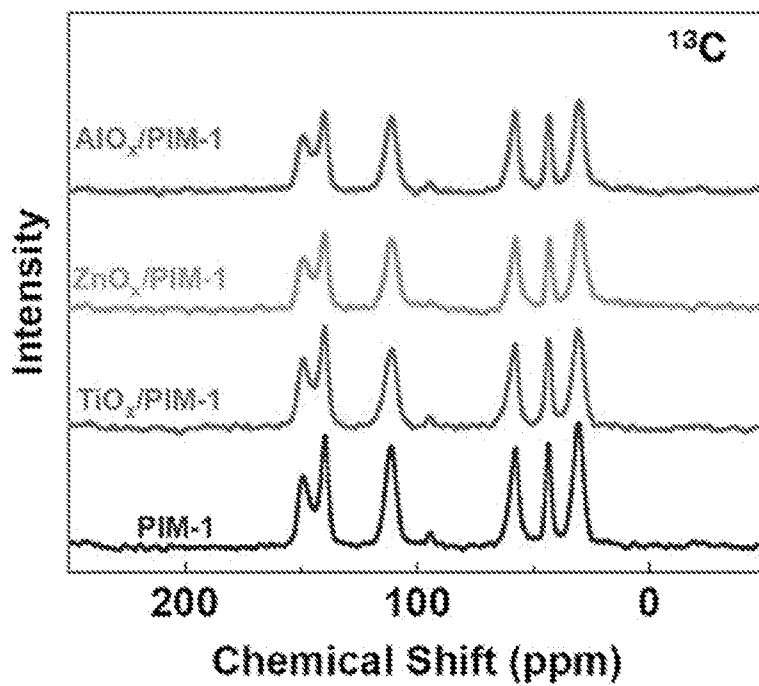

Figure 20

9/30

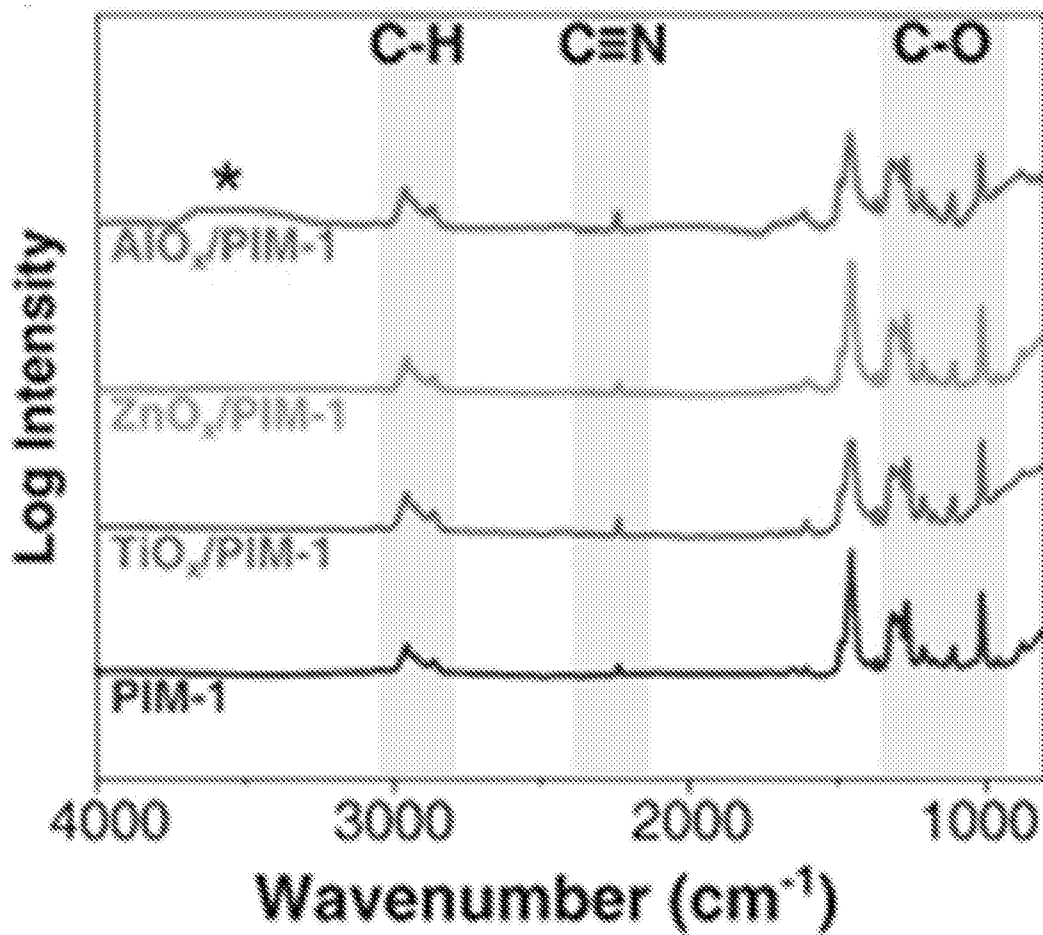

Figure 21

10/30

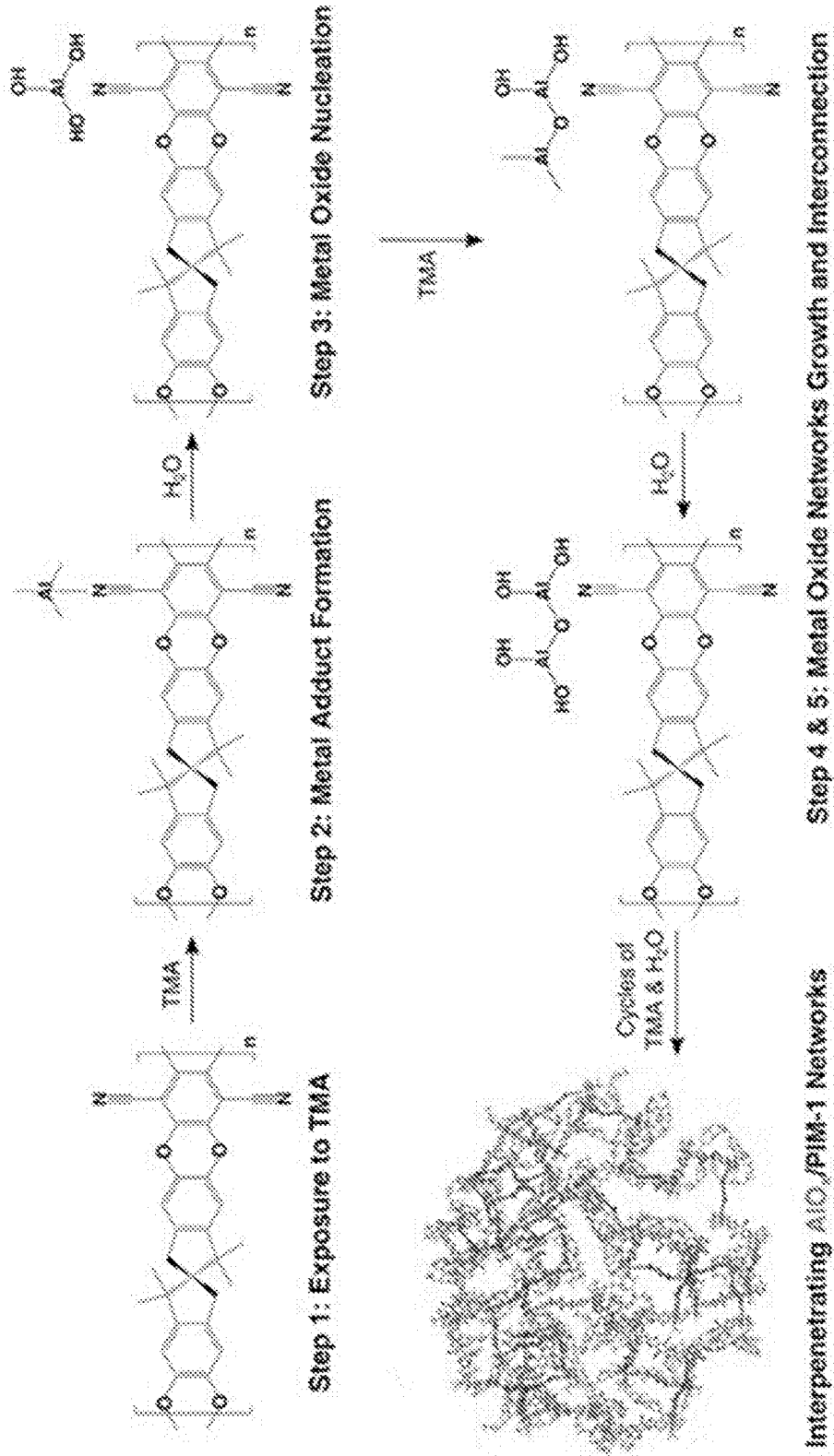

Figure 22

11/30

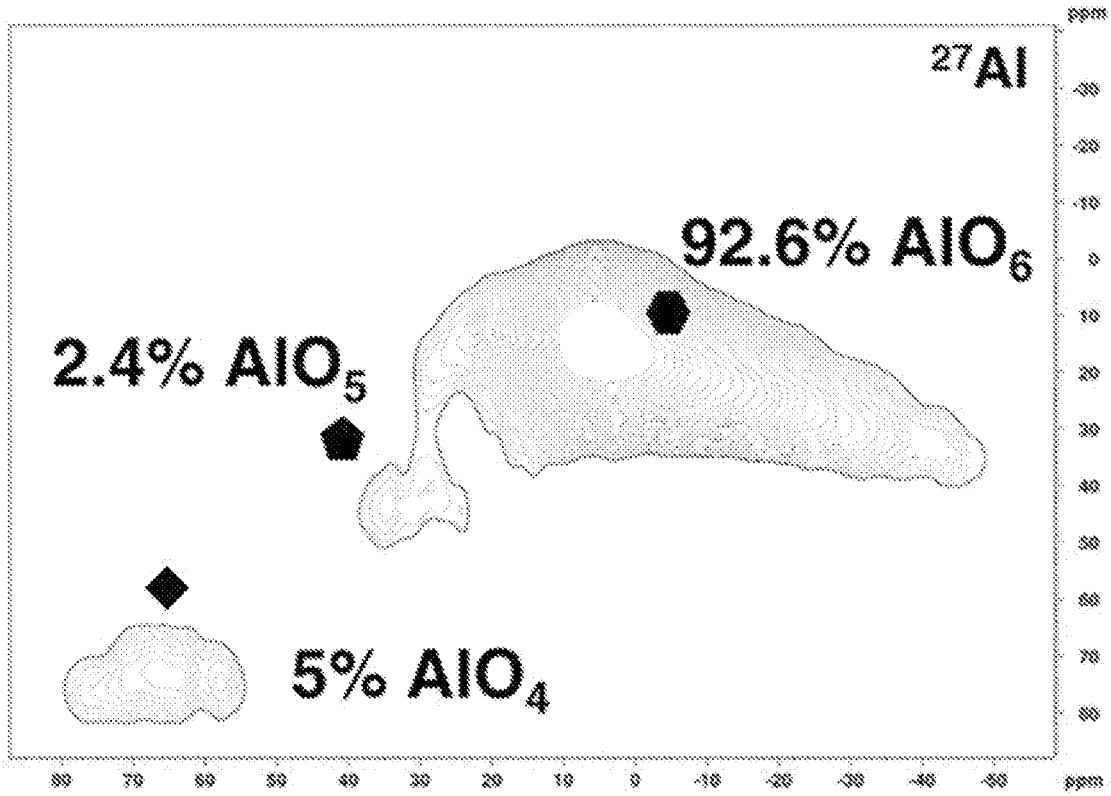

Figure 23

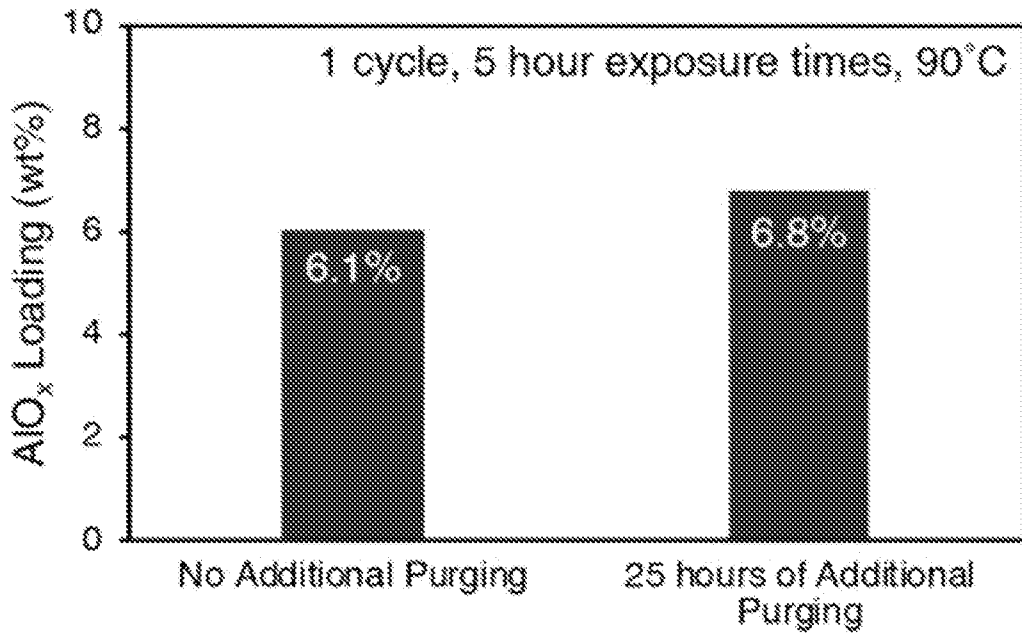

Figure 24

12/30

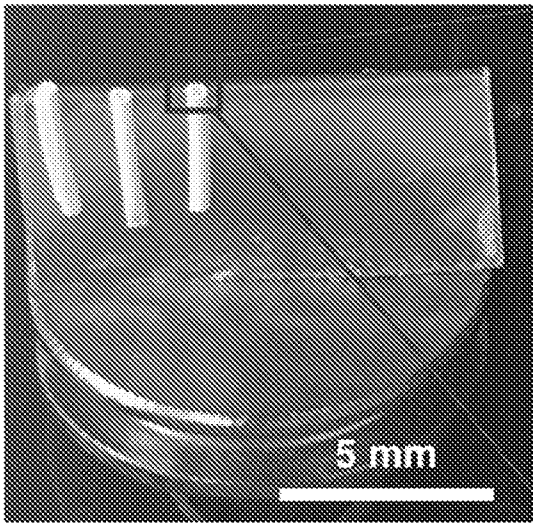

Figure 25

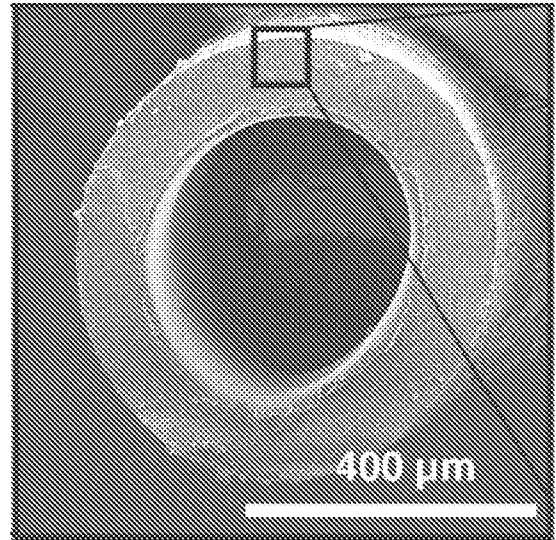

Figure 26

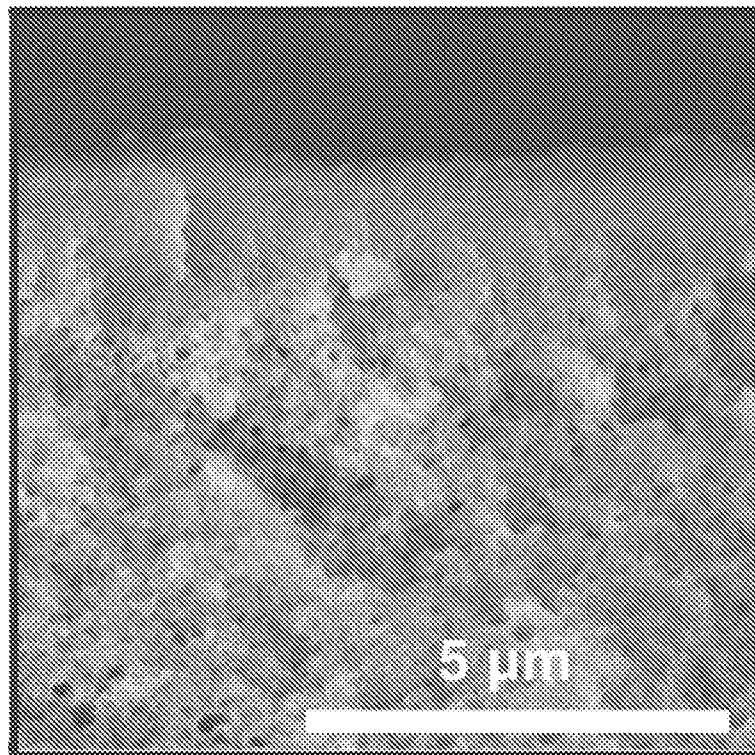

Figure 27

13/30

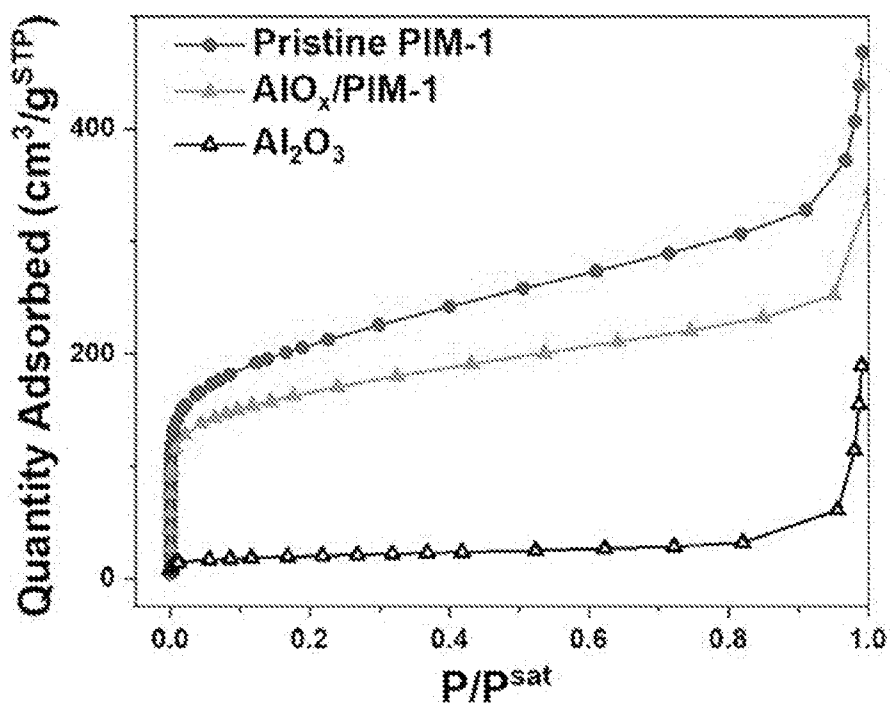

Figure 28

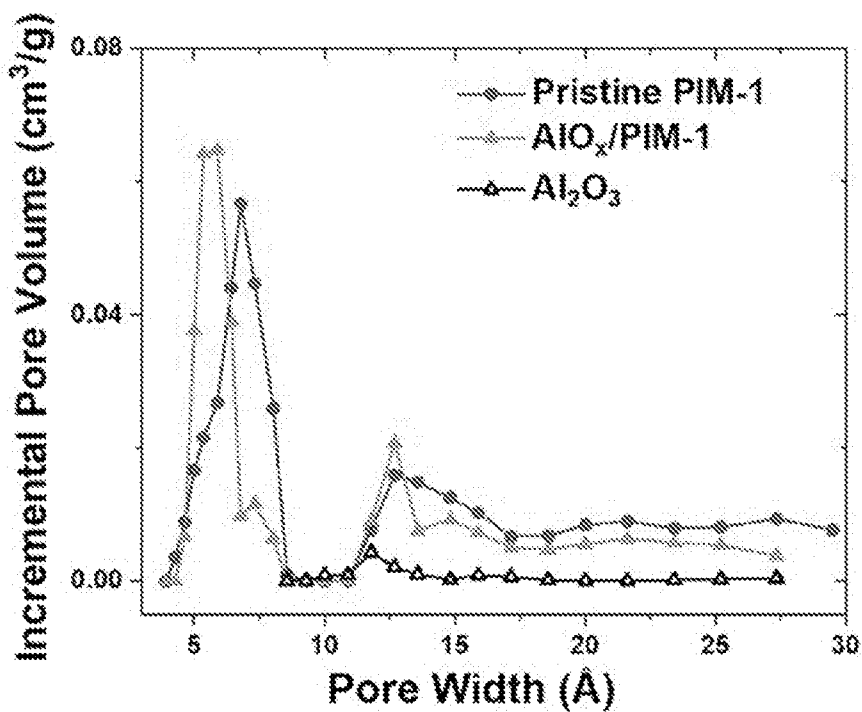

Figure 29

14/30

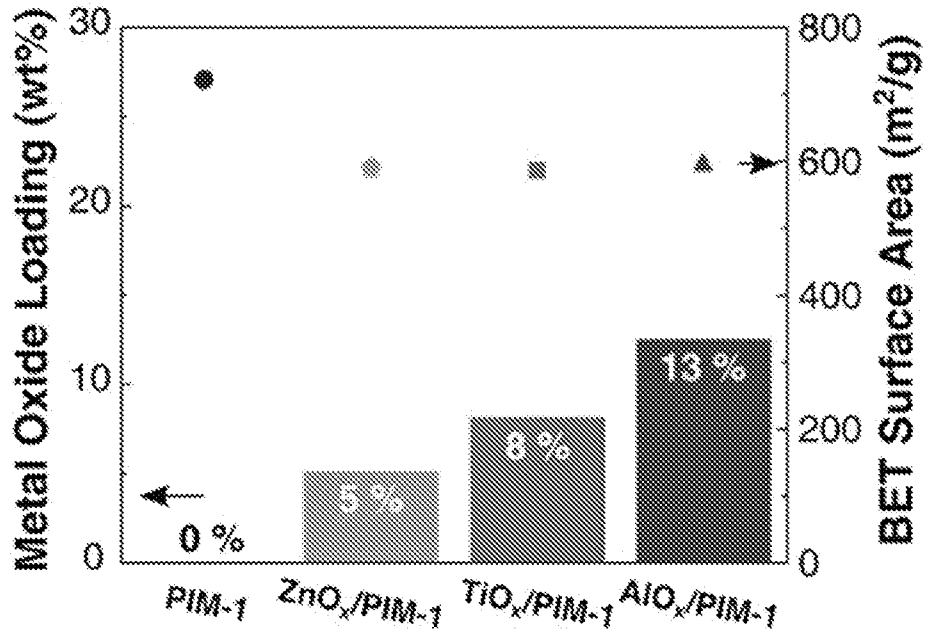

Figure 30

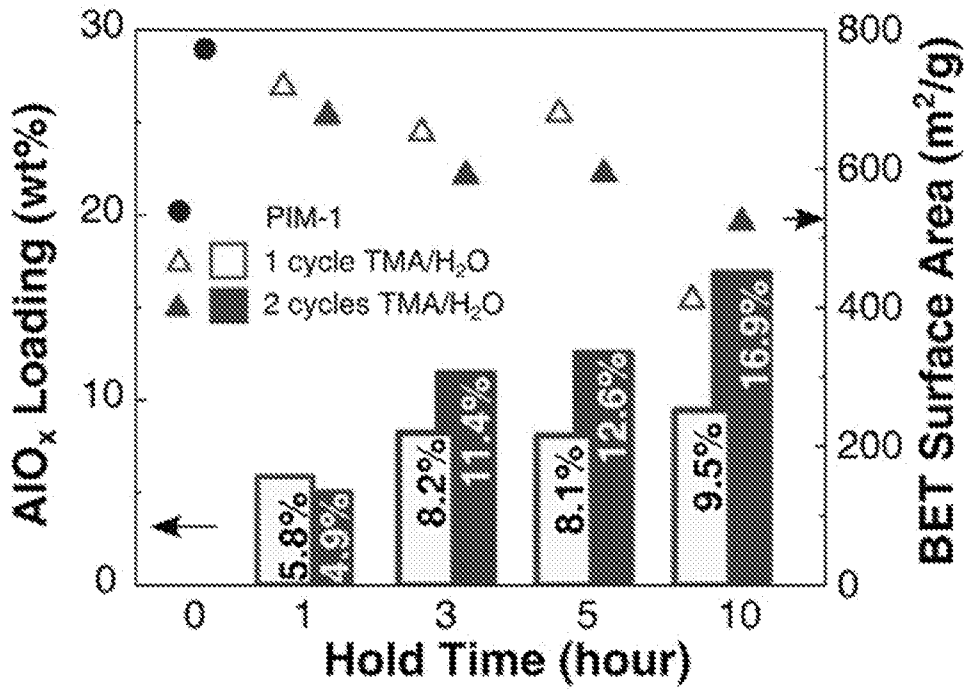

Figure 31

15/30

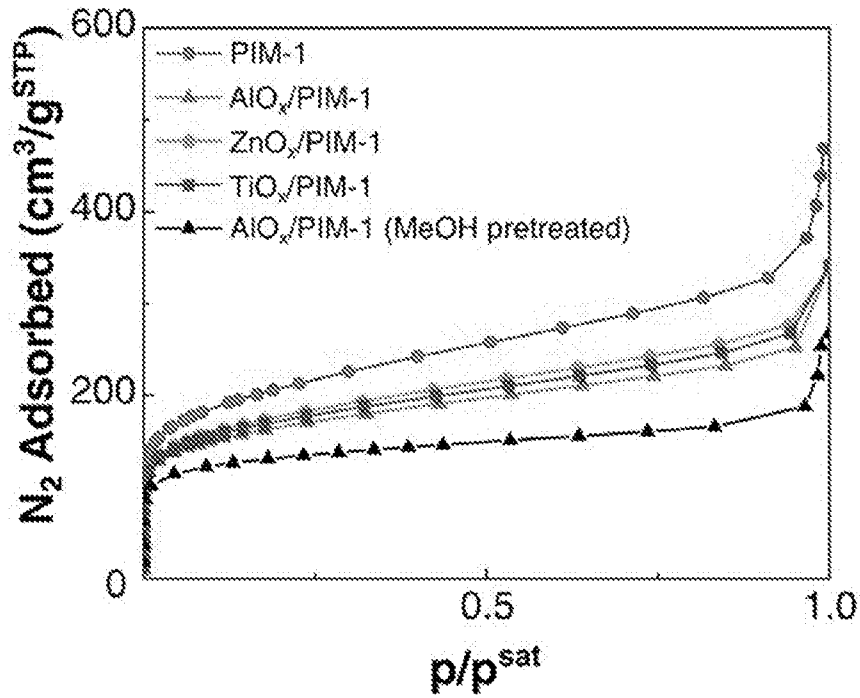

Figure 32

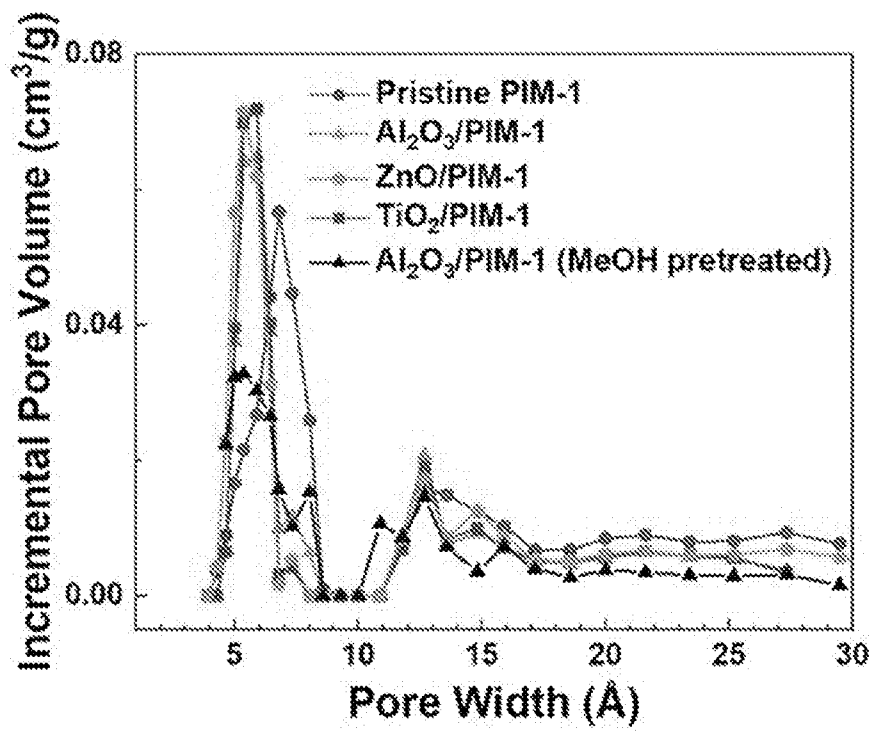

Figure 33

16/30

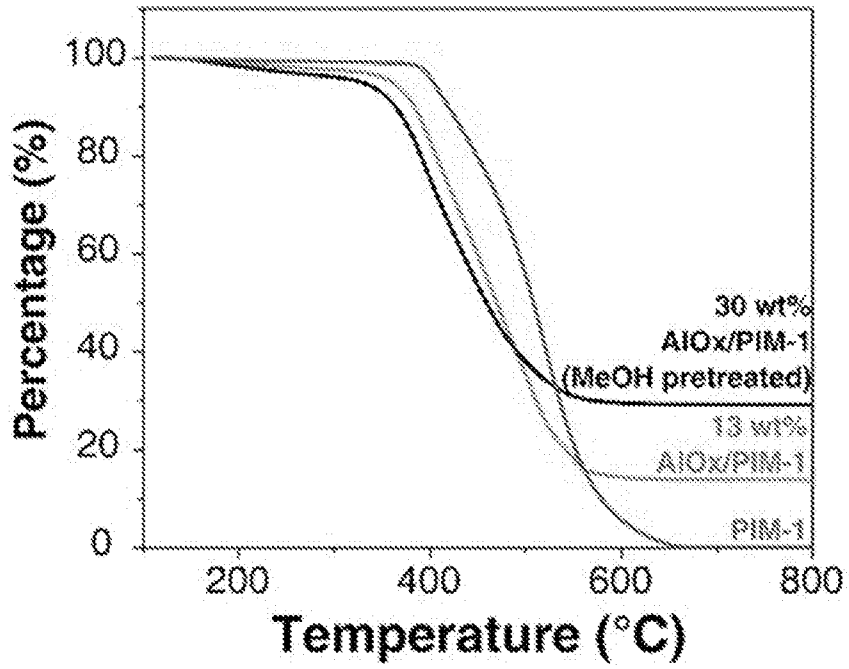

Figure 34

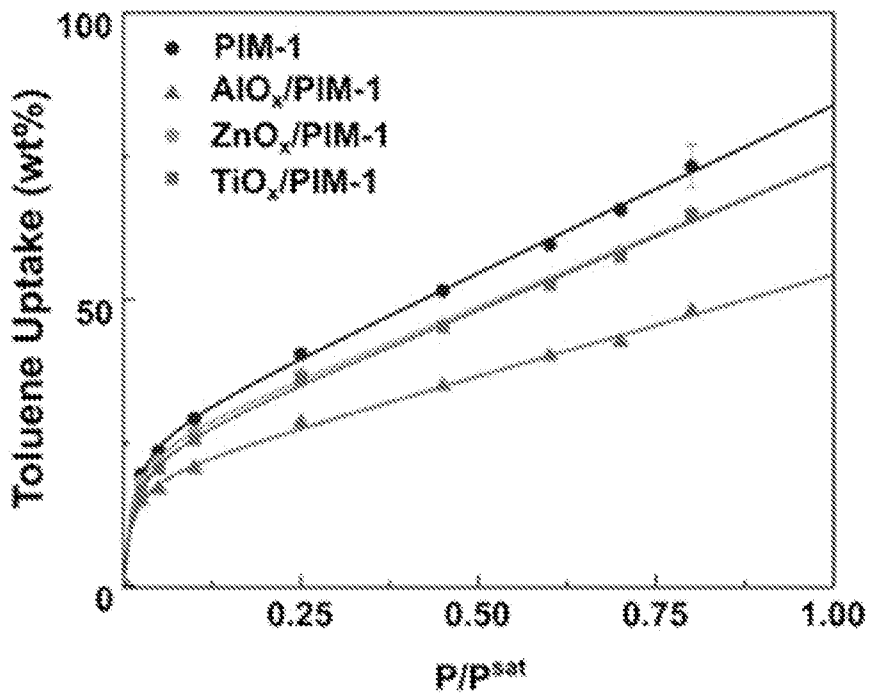

Figure 35

17/30

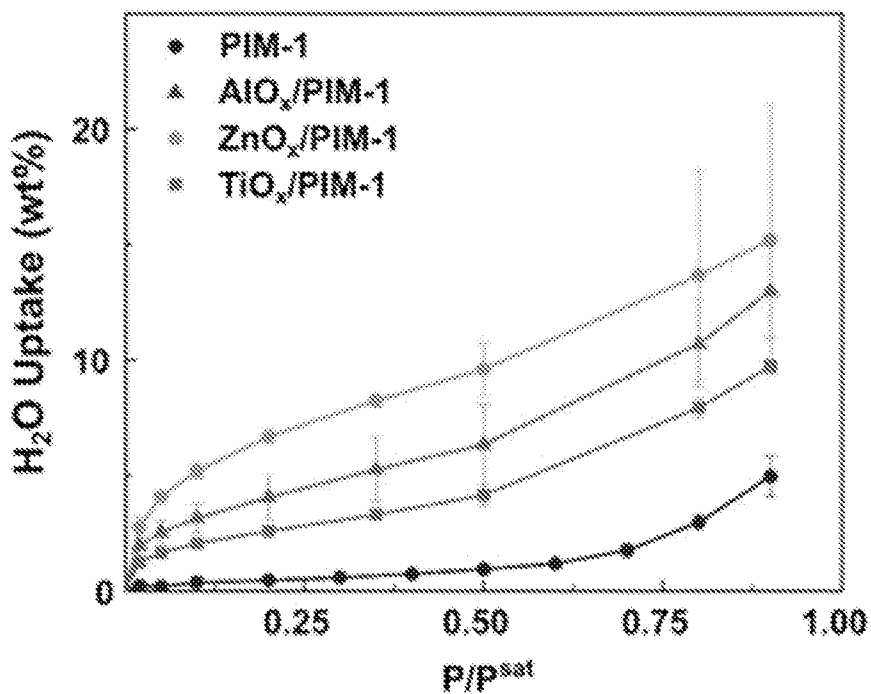
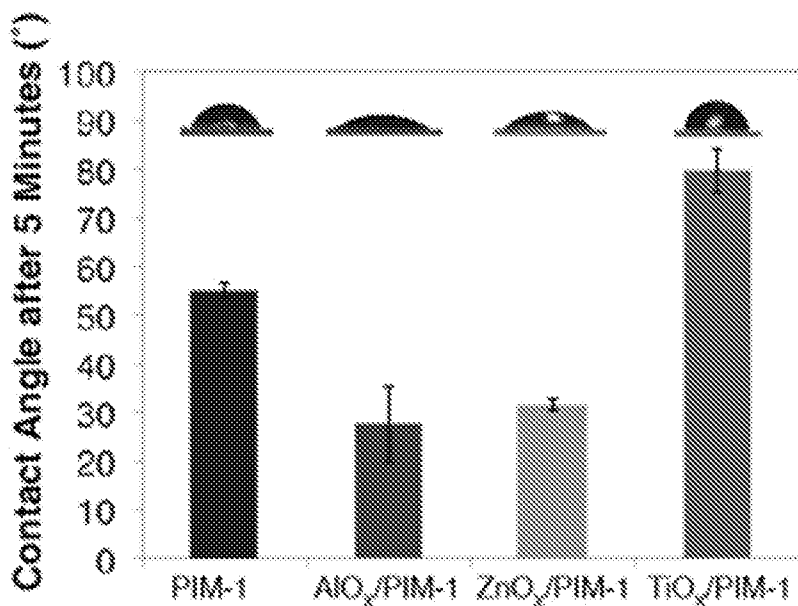

Figure 36



2 cycles, 5 hour holds of VPI Precursors at 90°C

Figure 37

18/30

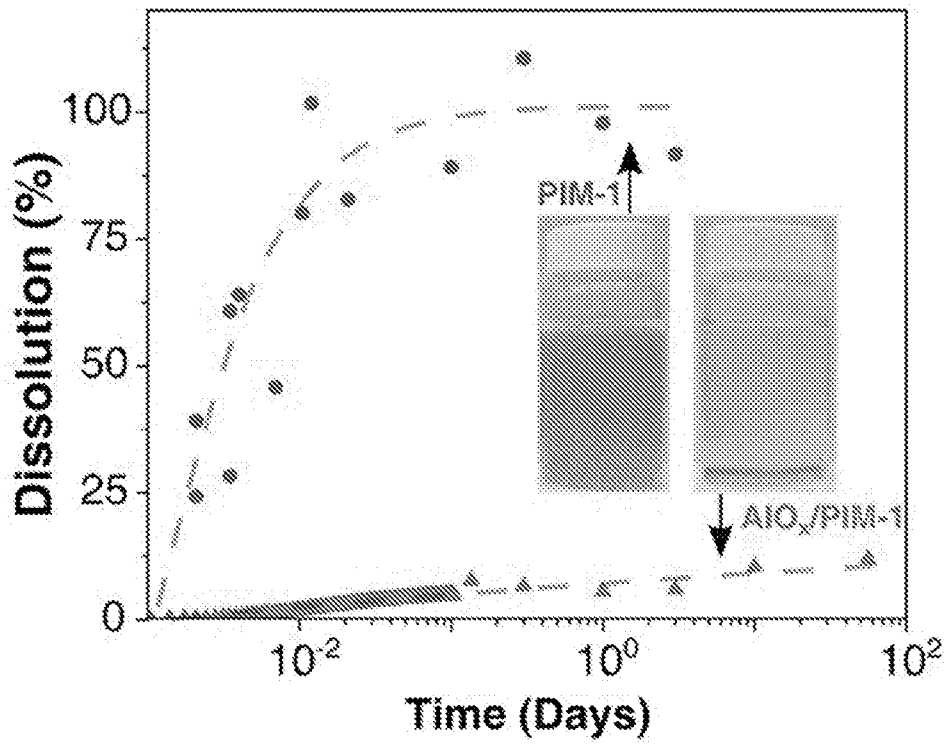

Figure 38

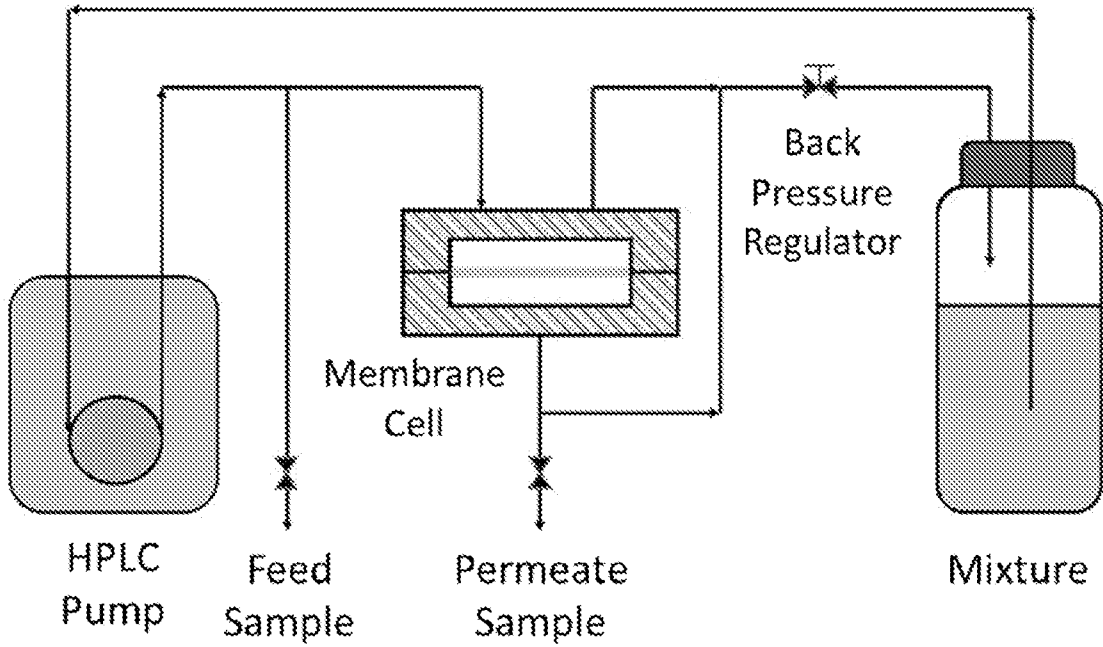

Figure 39

19/30

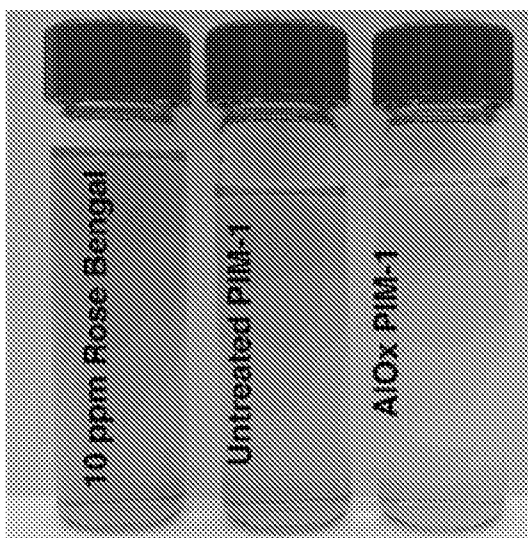

Figure 40

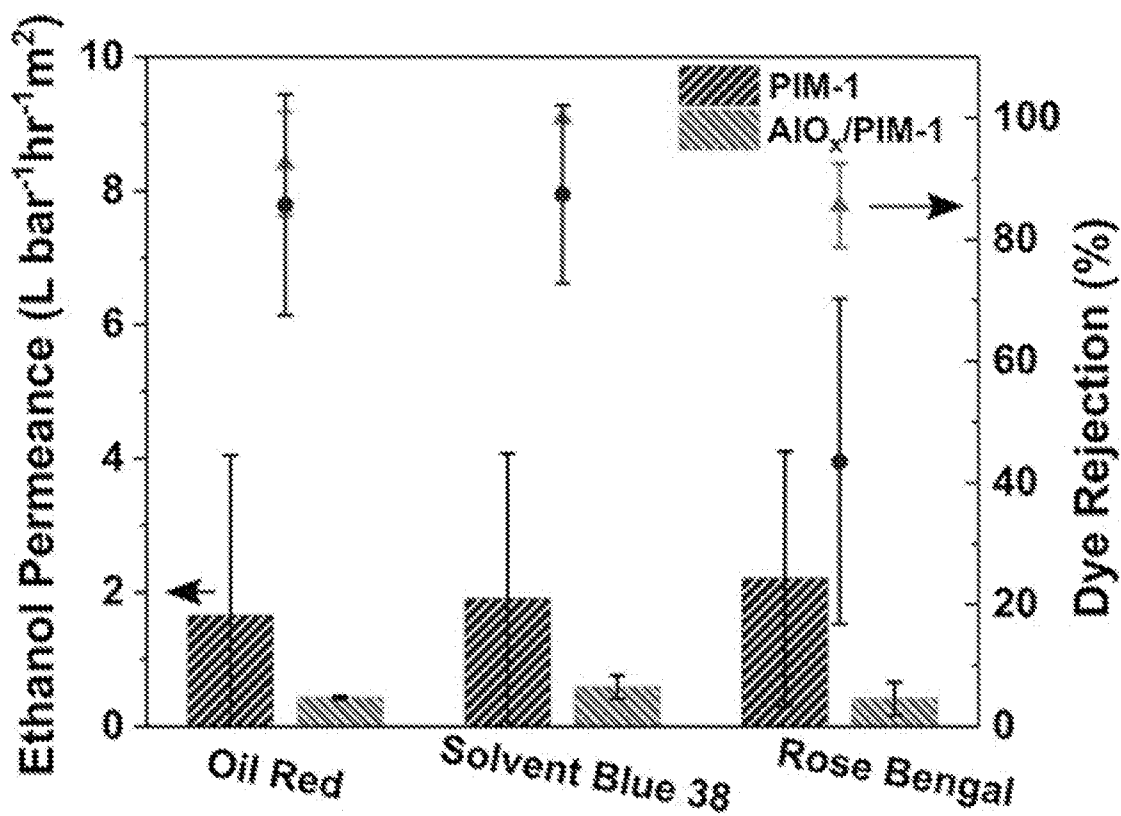

Figure 41

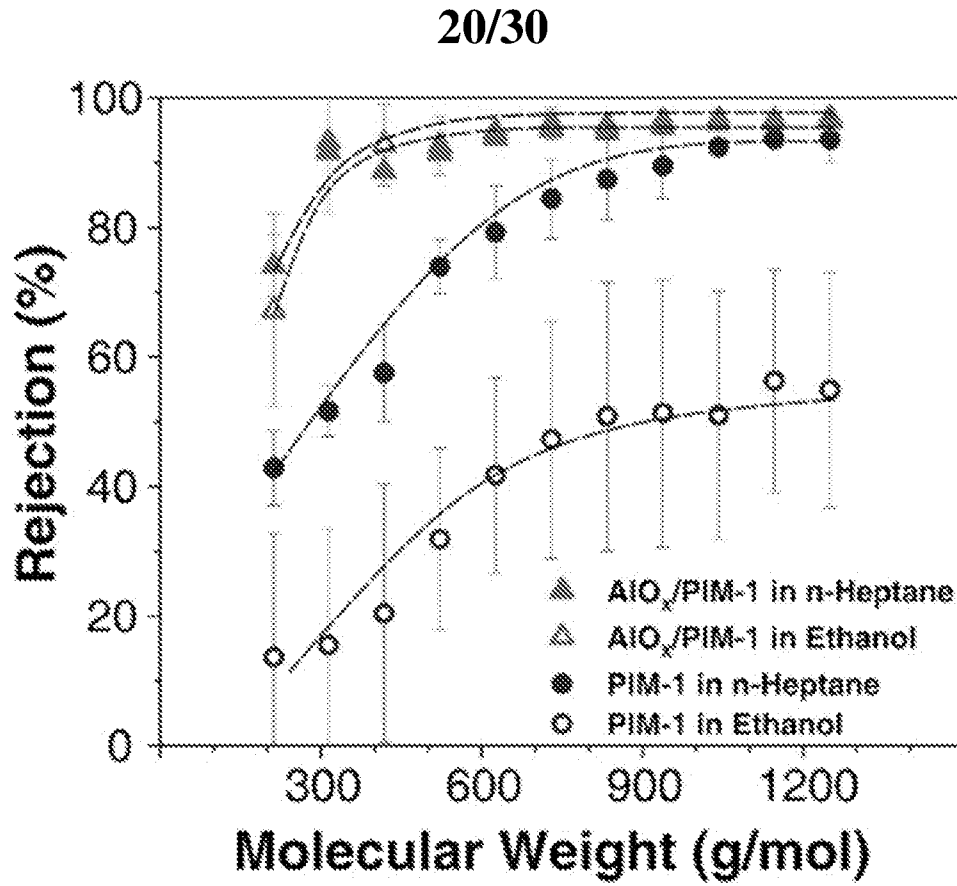

Figure 42

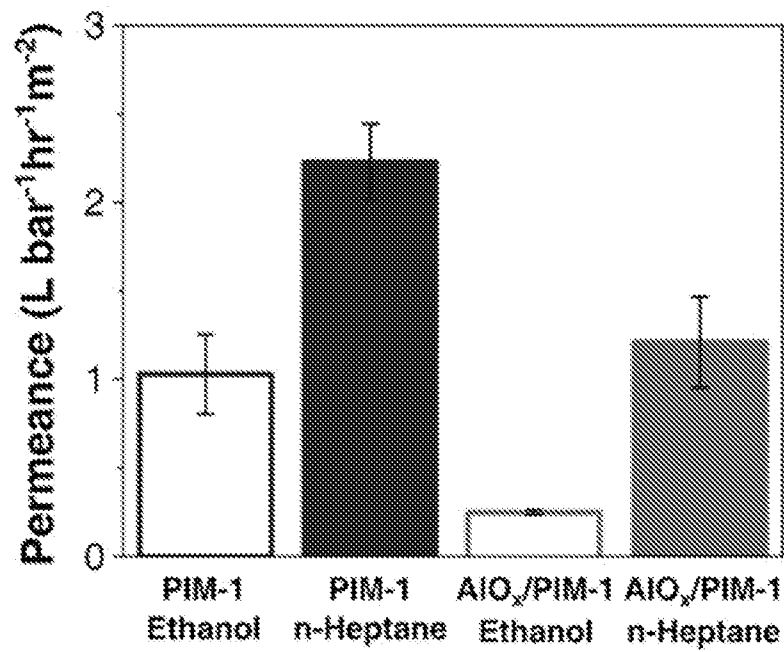

Figure 43

21/30

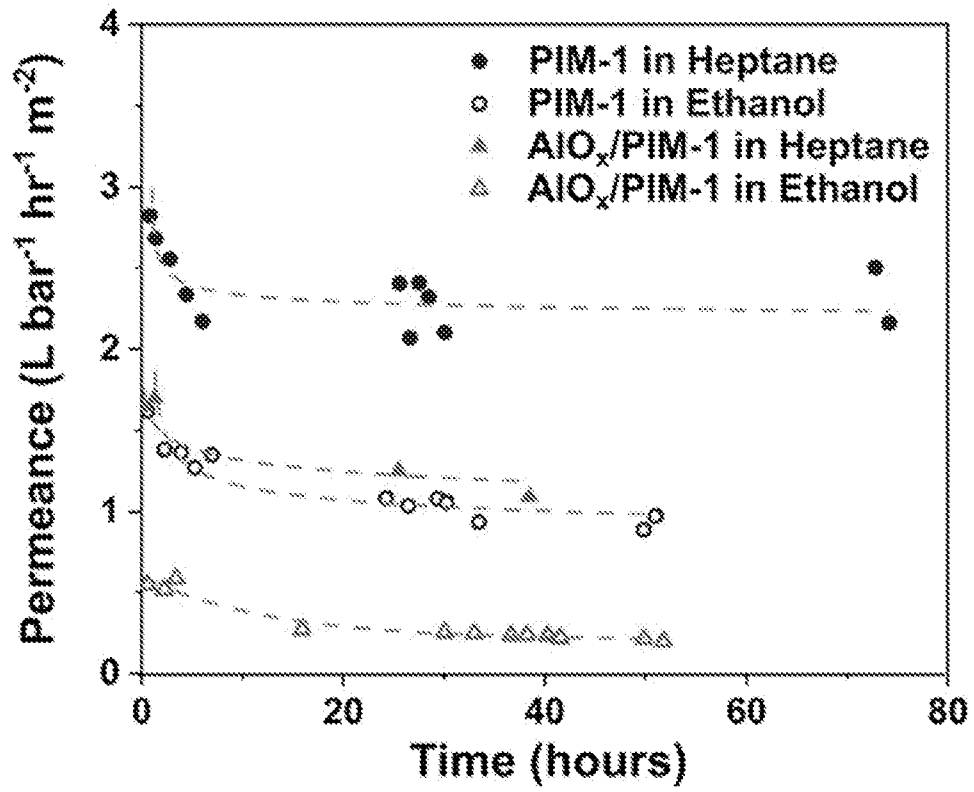

Figure 44

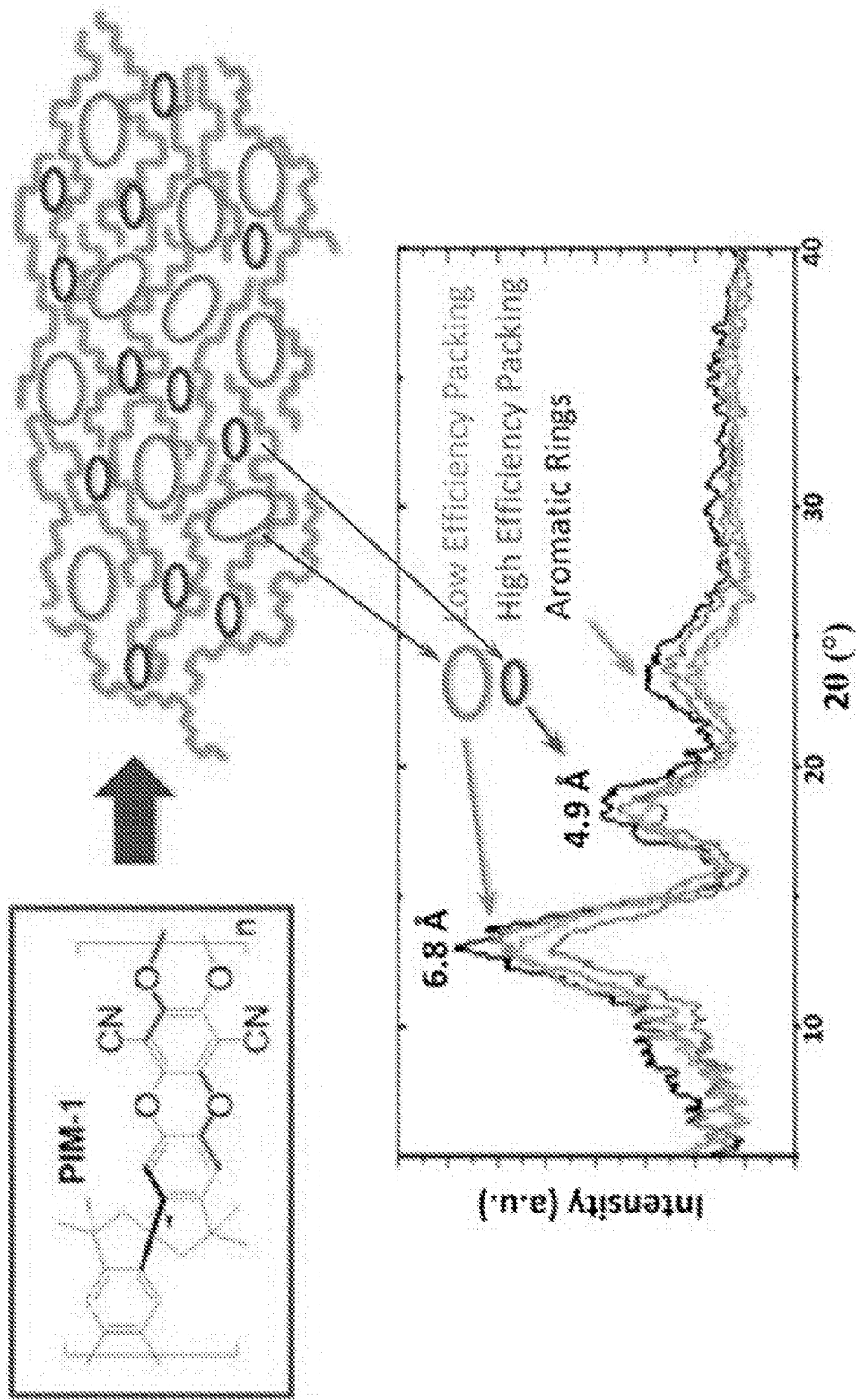
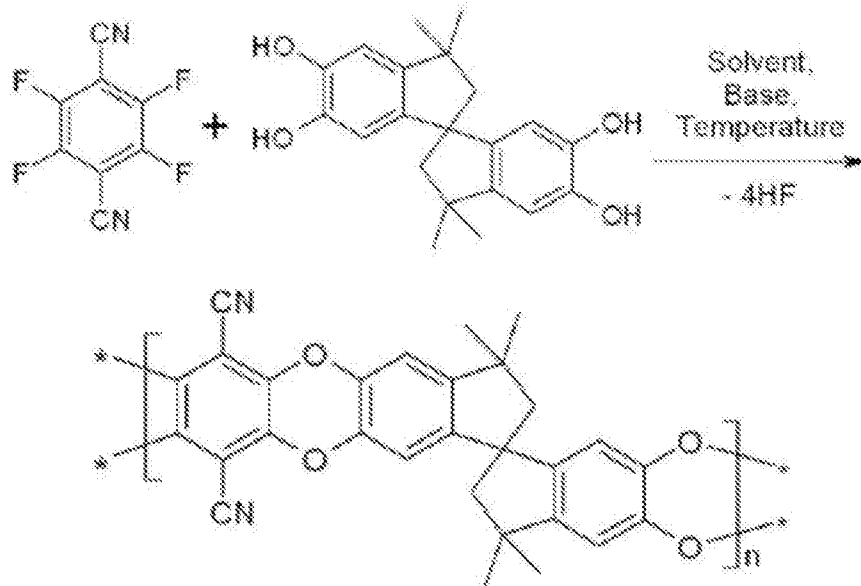

Figure 45

23/30

*Figure 46*

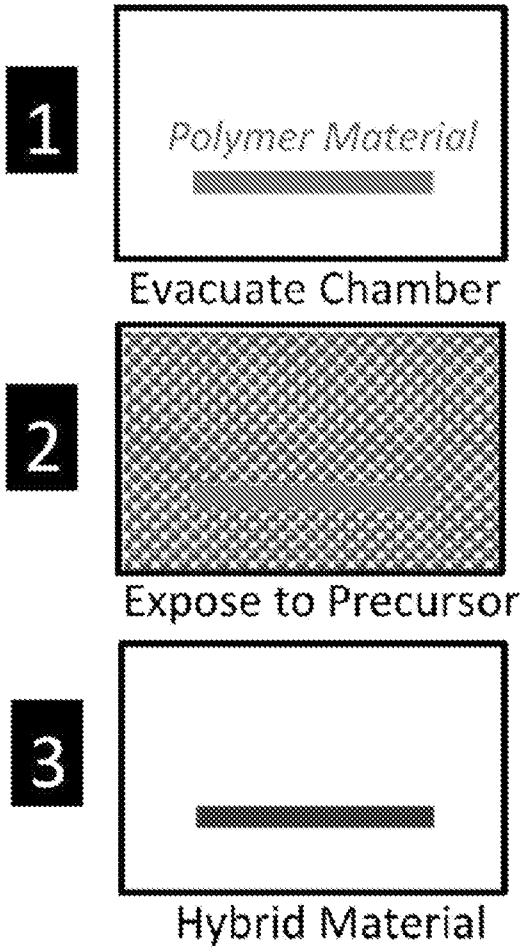

Figure 47

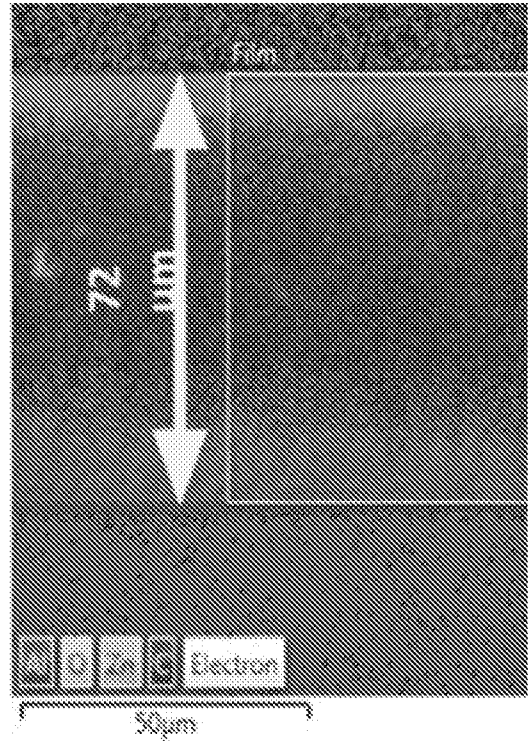

Figure 48

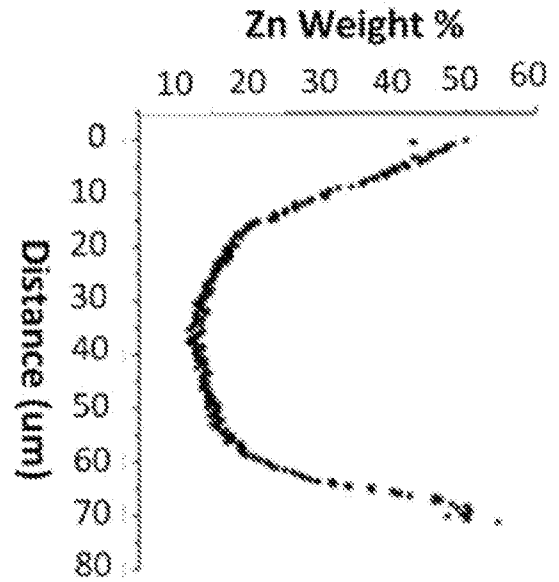

Figure 49

25/30

Infiltration of PIM-1 at 90°C, 2 cycles, 300 min holds

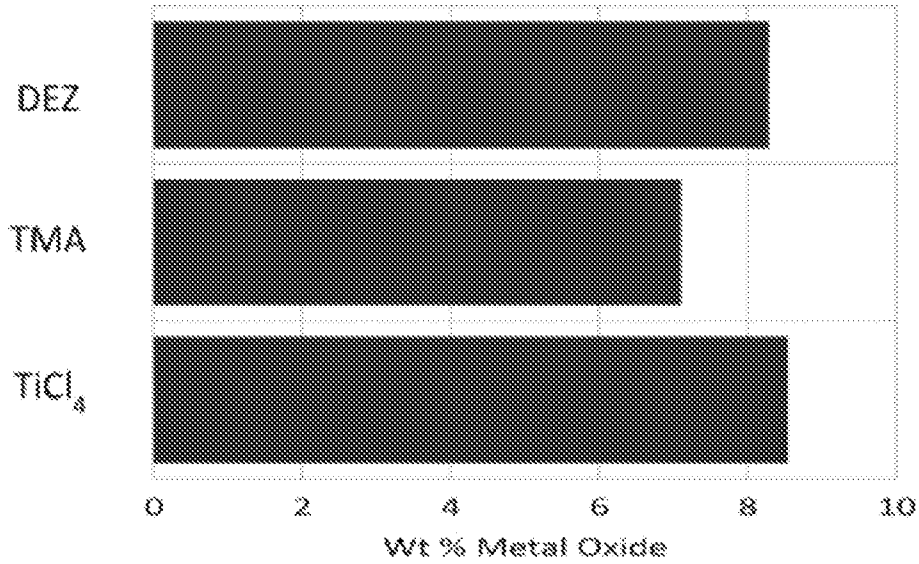

Figure 50

TMA / H₂O Infiltration of PIM-1 at 90°C

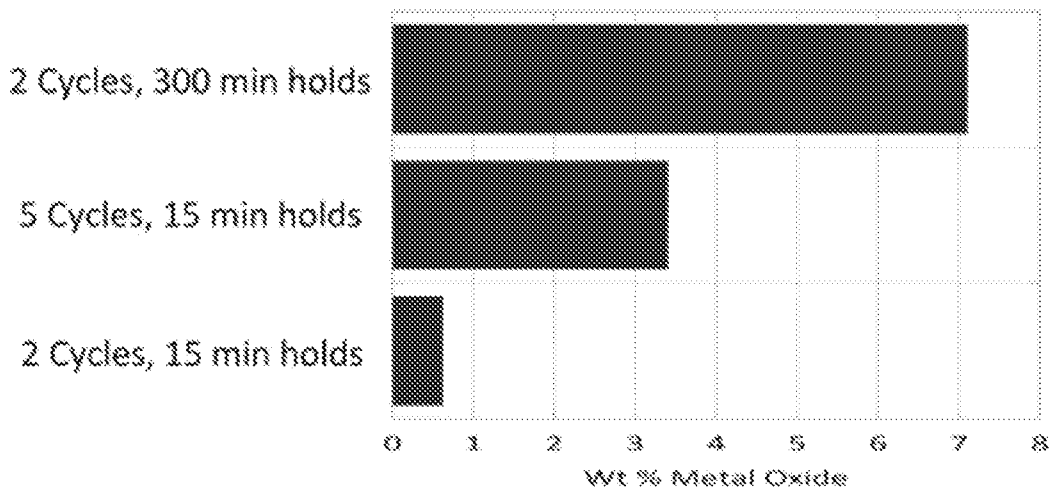

Figure 51

26/30

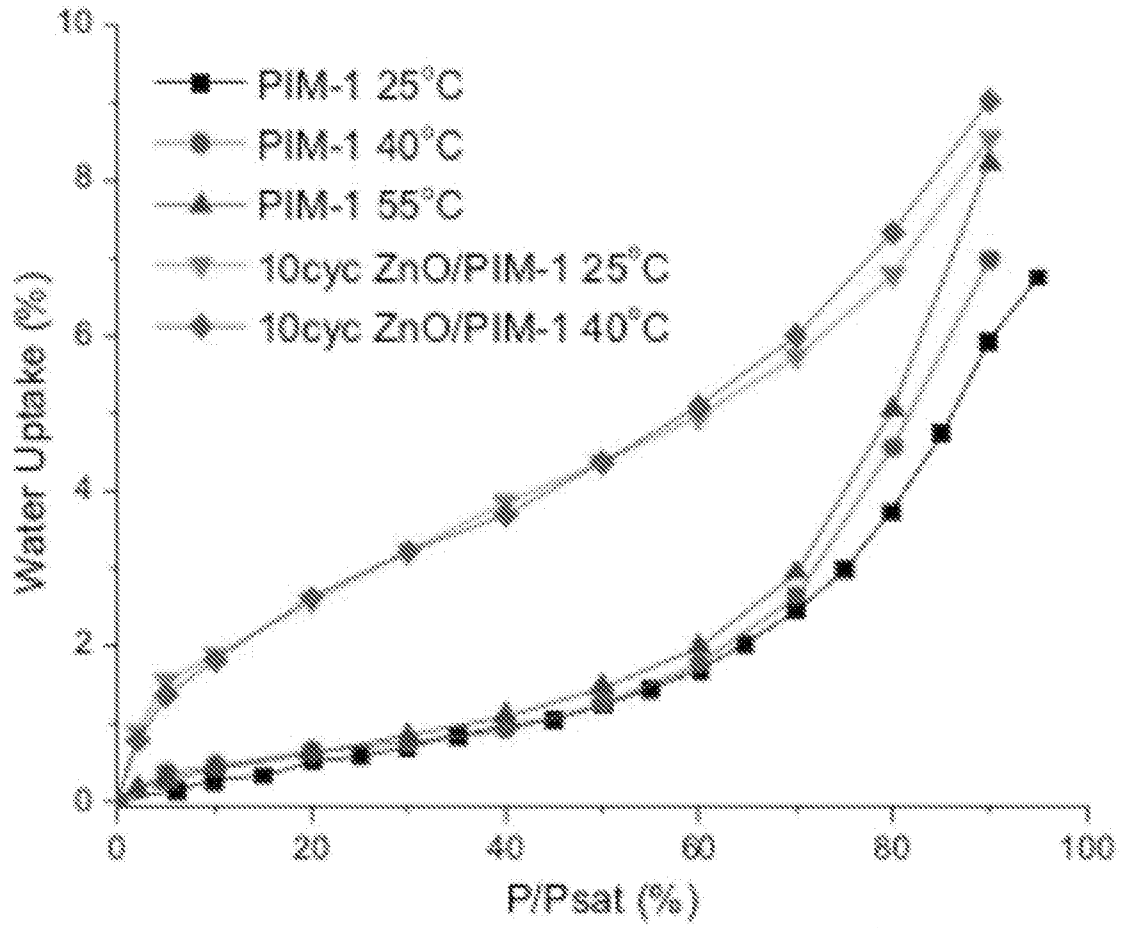

Figure 52

27/30

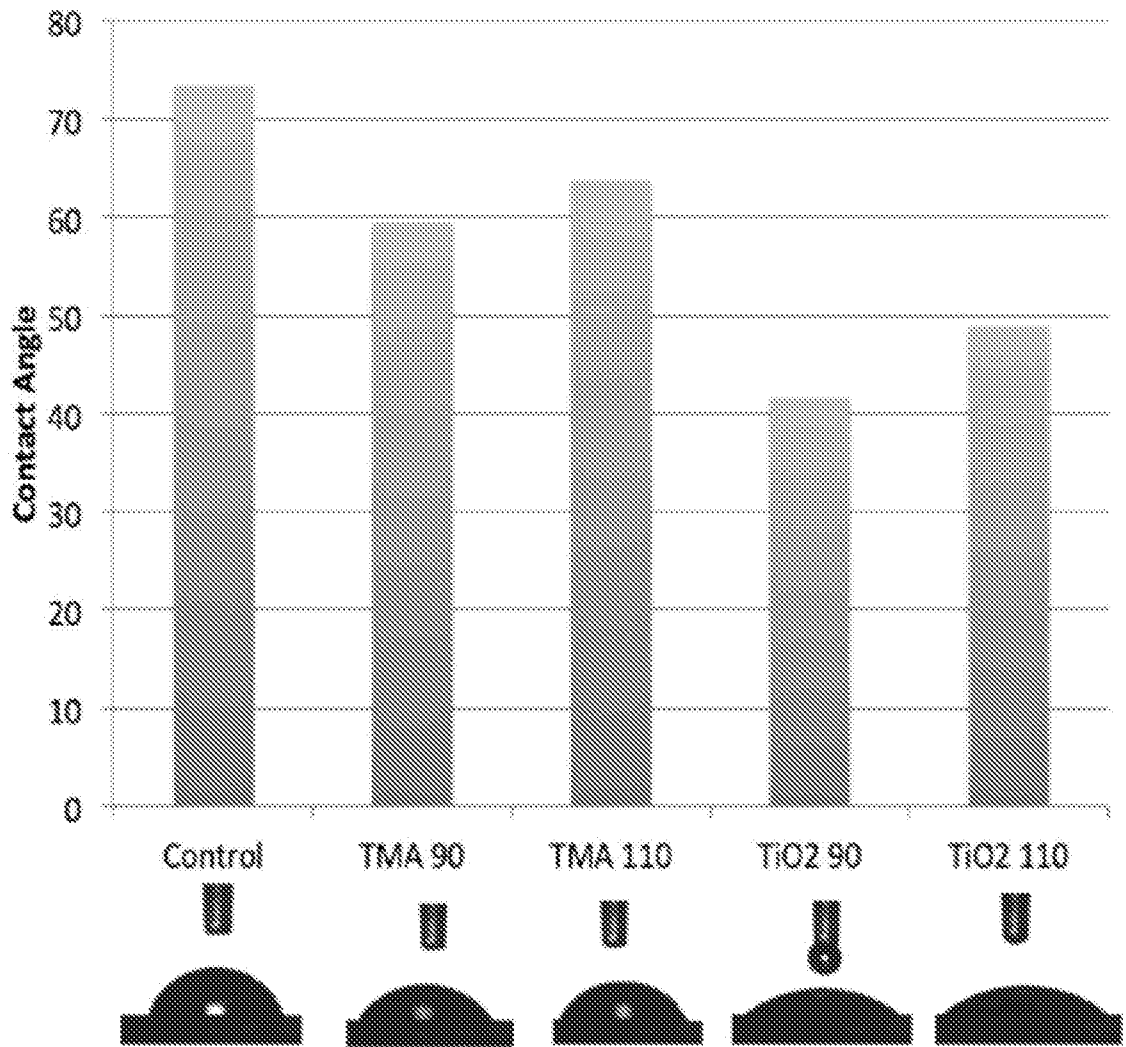

Figure 53

28/30

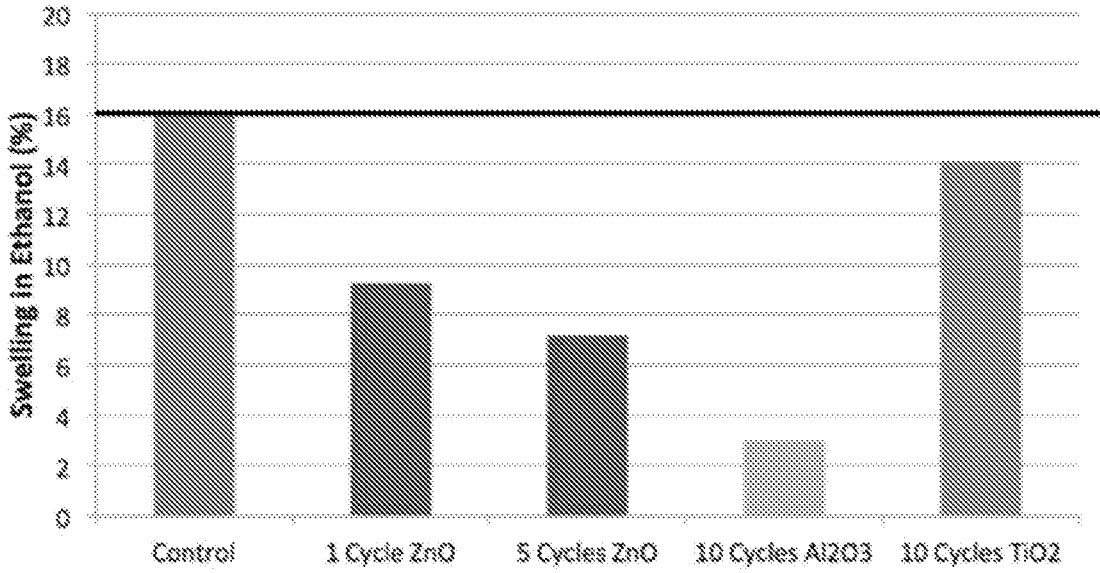

Figure 54

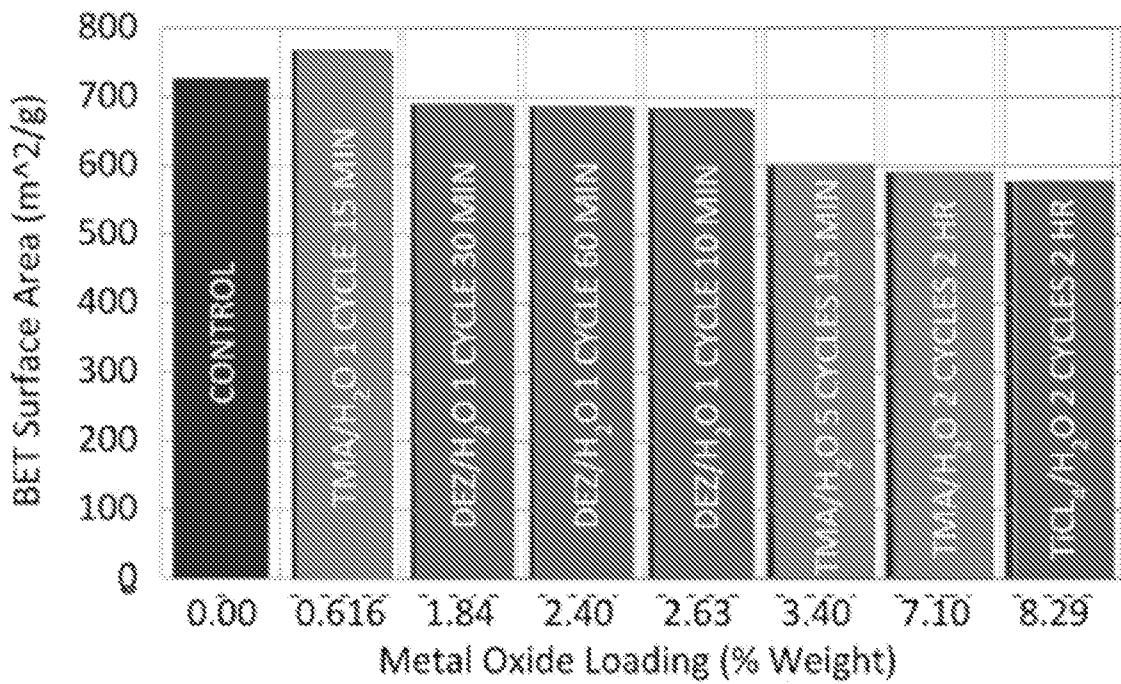

Figure 55

29/30

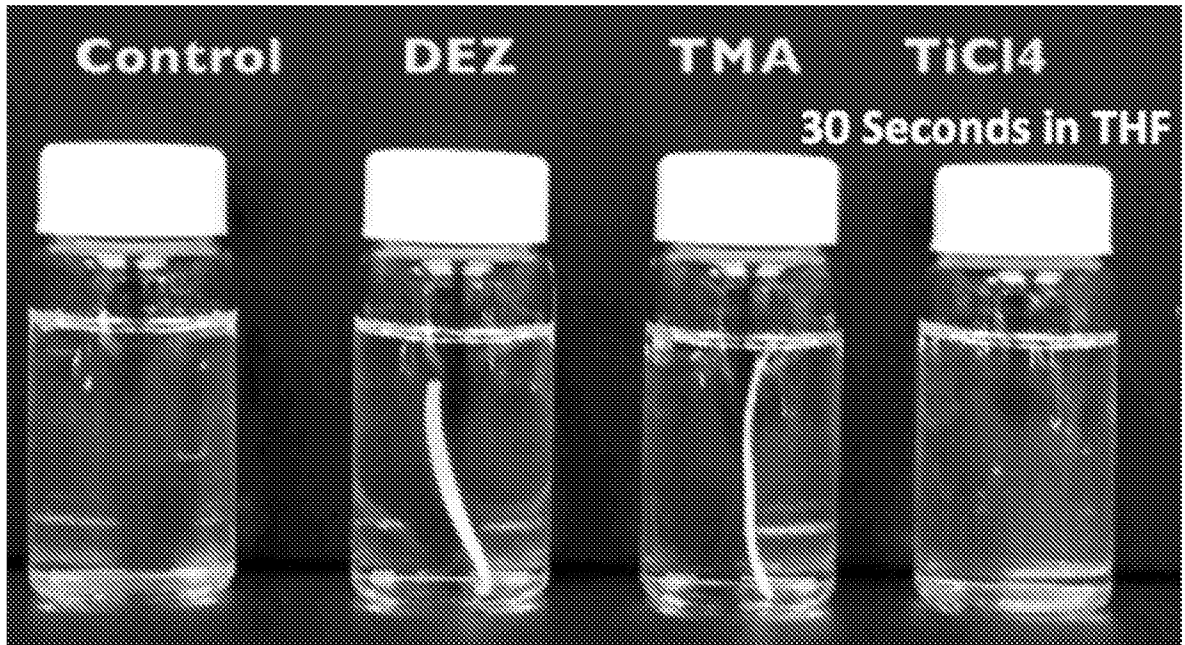

Figure 56

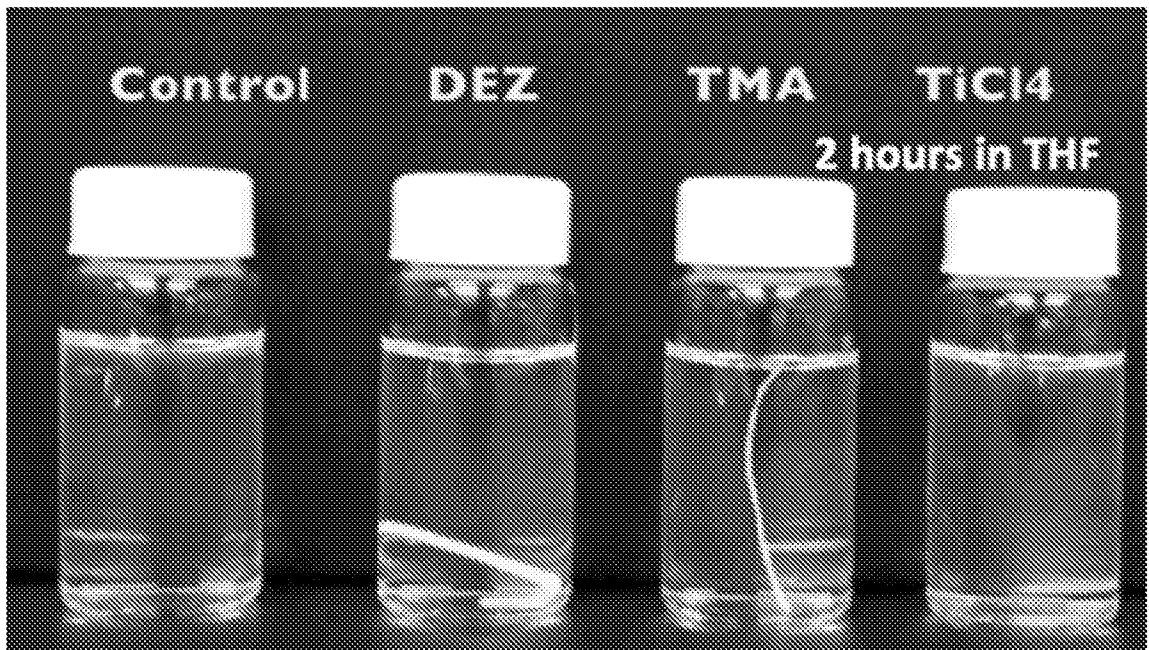

Figure 57

30/30



Figure 58



Figure 59

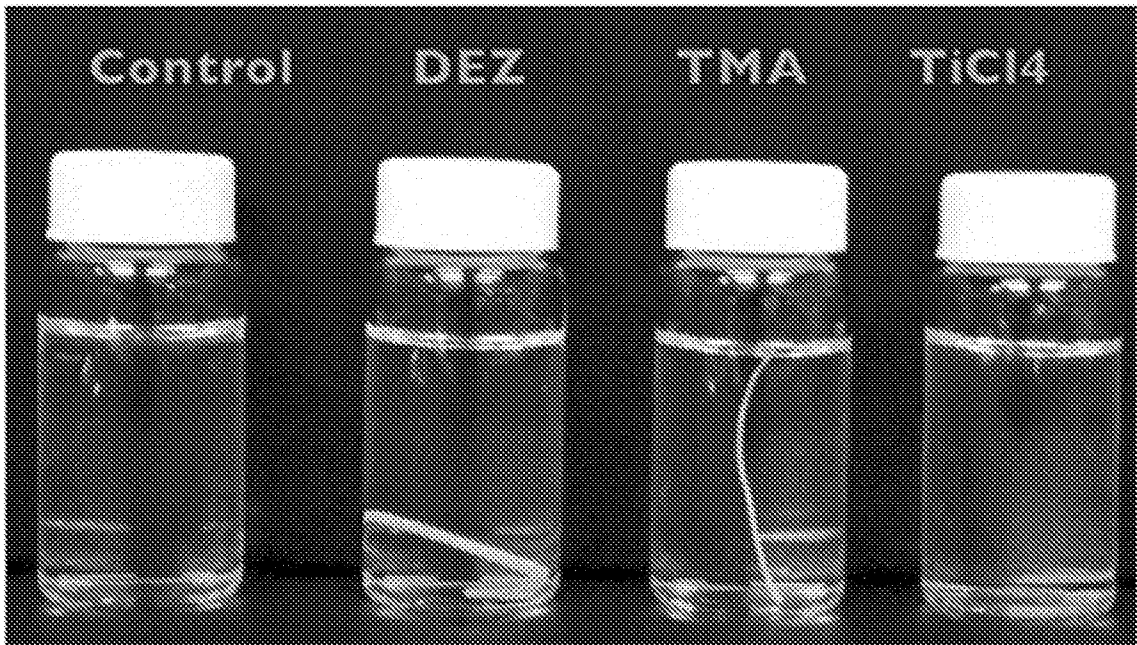

Figure 60

INTERNATIONAL SEARCH REPORT

International application No.

PCT/US 18/58347

Box No. II Observations where certain claims were found unsearchable (Continuation of item 2 of first sheet)

This international search report has not been established in respect of certain claims under Article 17(2)(a) for the following reasons:

1. Claims Nos.:
because they relate to subject matter not required to be searched by this Authority, namely:

2. Claims Nos.:
because they relate to parts of the international application that do not comply with the prescribed requirements to such an extent that no meaningful international search can be carried out, specifically:

3. Claims Nos.:
because they are dependent claims and are not drafted in accordance with the second and third sentences of Rule 6.4(a).

Box No. III Observations where unity of invention is lacking (Continuation of item 3 of first sheet)

This International Searching Authority found multiple inventions in this international application, as follows:

1. As all required additional search fees were timely paid by the applicant, this international search report covers all searchable claims.
2. As all searchable claims could be searched without effort justifying additional fees, this Authority did not invite payment of additional fees.
3. As only some of the required additional search fees were timely paid by the applicant, this international search report covers only those claims for which fees were paid, specifically claims Nos.:

4. No required additional search fees were timely paid by the applicant. Consequently, this international search report is restricted to the invention first mentioned in the claims; it is covered by claims Nos.:

Remark on Protest

- The additional search fees were accompanied by the applicant's protest and, where applicable, the payment of a protest fee.
- The additional search fees were accompanied by the applicant's protest but the applicable protest fee was not paid within the time limit specified in the invitation.
- No protest accompanied the payment of additional search fees.

INTERNATIONAL SEARCH REPORT

International application No.

PCT/US 18/58347

A. CLASSIFICATION OF SUBJECT MATTER
 IPC(8) - H01M 2/16 (2018.01)
 CPC - C08J 5/22, H01M 10/056, H01M 12/02

According to International Patent Classification (IPC) or to both national classification and IPC

B. FIELDS SEARCHED

Minimum documentation searched (classification system followed by classification symbols)

See Search History Document

Documentation searched other than minimum documentation to the extent that such documents are included in the fields searched

See Search History Document

Electronic data base consulted during the international search (name of data base and, where practicable, search terms used)

See Search History Document

C. DOCUMENTS CONSIDERED TO BE RELEVANT

Category*	Citation of document, with indication, where appropriate, of the relevant passages	Relevant to claim No.
X	US 2016/0367948 A1 (Kyoto University) 22 December 2016 (22.12.2016); entire document, especially claim 1, claim 5-6, claim 9, [0001], [0156]-[0158], [0166]	1-4
X	US 2017/0274327 A1 (Georgia Institute of Technology) 28 September 2017 (28.09.2017); entire document	1-4
X	US 2010/0035047 A1 (Ajayan et al.) 11 February 2010 (11.02.2010); entire document	1-4
A	US 2007/0137477 A1 (Freeman et al.) 21 June 2007 (21.06.2007); entire document	1-4

Further documents are listed in the continuation of Box C.

See patent family annex.

* Special categories of cited documents:

"A" document defining the general state of the art which is not considered to be of particular relevance

"E" earlier application or patent but published on or after the international filing date

"L" document which may throw doubts on priority claim(s) or which is cited to establish the publication date of another citation or other special reason (as specified)

"O" document referring to an oral disclosure, use, exhibition or other means

"P" document published prior to the international filing date but later than the priority date claimed

"T" later document published after the international filing date or priority date and not in conflict with the application but cited to understand the principle or theory underlying the invention

"X" document of particular relevance; the claimed invention cannot be considered novel or cannot be considered to involve an inventive step when the document is taken alone

"Y" document of particular relevance; the claimed invention cannot be considered to involve an inventive step when the document is combined with one or more other such documents, such combination being obvious to a person skilled in the art

"&" document member of the same patent family

Date of the actual completion of the international search

20 December 2018

Date of mailing of the international search report

16 JAN 2019

Name and mailing address of the ISA/US

Mail Stop PCT, Attn: ISA/US, Commissioner for Patents
 P.O. Box 1450, Alexandria, Virginia 22313-1450
 Facsimile No. 571-273-8300

Authorized officer:

Lee W. Young

PCT Helpdesk: 571-272-4300
 PCT OSP: 571-272-7774