



US00D717689S

(12) **United States Design Patent**
Modderman et al.

(10) **Patent No.:** **US D717,689 S**

(45) **Date of Patent:** **** Nov. 18, 2014**

(54) **LIGHTED TREE ORNAMENT**

(71) Applicants: **Nathan Modderman**, Bigfork, MT
(US); **Steven Modderman**, Bigfork, MT
(US)

(72) Inventors: **Nathan Modderman**, Bigfork, MT
(US); **Steven Modderman**, Bigfork, MT
(US)

(73) Assignee: **LMD Investments, LLC**, Bigfork, MT
(US)

(**) Term: **14 Years**

(21) Appl. No.: **29/471,071**

(22) Filed: **Oct. 28, 2013**

(51) **LOC (10) Cl.** **11-04**

(52) **U.S. Cl.**

USPC **D11/124**

(58) **Field of Classification Search**

USPC D11/117, 121, 124, 125, 130, 131, 132,
D11/133, 157; 428/7, 8, 9, 11, 12; D29/102;
D2/865, 872, 873, 878, 879; 2/410,
2/425; D26/2, 57, 94, 125; 362/565, 806
See application file for complete search history.

(56) **References Cited**

U.S. PATENT DOCUMENTS

D226,676 S * 4/1973 Felsen D26/94
D365,297 S * 12/1995 Phurrough D11/118
D383,137 S * 9/1997 Gamble et al. D14/230
5,702,781 A * 12/1997 Barker 428/16
D443,846 S * 6/2001 Aldridge D11/125

D480,984 S * 10/2003 Trapani et al. D11/125
D518,943 S * 4/2006 Levinson D2/879
D593,284 S * 6/2009 Wymmer D2/879
D613,200 S * 4/2010 Modderman et al. D11/124
D629,182 S * 12/2010 Castiel D2/882
D636,562 S * 4/2011 Lam et al. D2/882
D663,926 S * 7/2012 Richards D2/882
D672,535 S * 12/2012 Phan D2/882
D693,099 S * 11/2013 Purdy D2/882
D703,418 S * 4/2014 Sisera D2/882

* cited by examiner

Primary Examiner — Elizabeth J Oswecki

(74) *Attorney, Agent, or Firm* — Paine Hamblen, LLP

(57) **CLAIM**

We claim the ornamental design for a lighted tree ornament,
as shown and described.

DESCRIPTION

FIG. 1 is a perspective view of a lighted tree ornament, showing our new design, in a used condition with a tree shown in broken lines;

FIG. 2 is another perspective view of the lighted tree ornament;

FIG. 3 is a right side elevation view thereof;

FIG. 4 is a front elevation view thereof;

FIG. 5 is a rear elevation view thereof;

FIG. 6 is a top plan view thereof; and,

FIG. 7 is a bottom plan view thereof.

The broken lines shown in the drawings represent portions of the lighted tree ornament that form no part of the claimed design.

All surfaces not shown form no part of the claimed design.

1 Claim, 7 Drawing Sheets

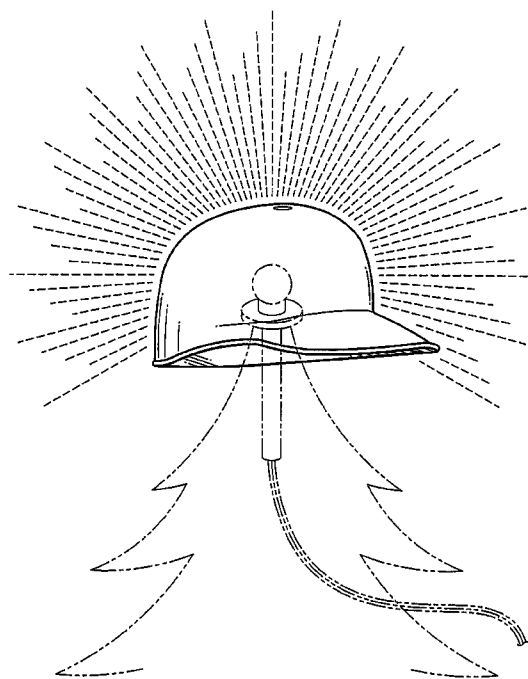

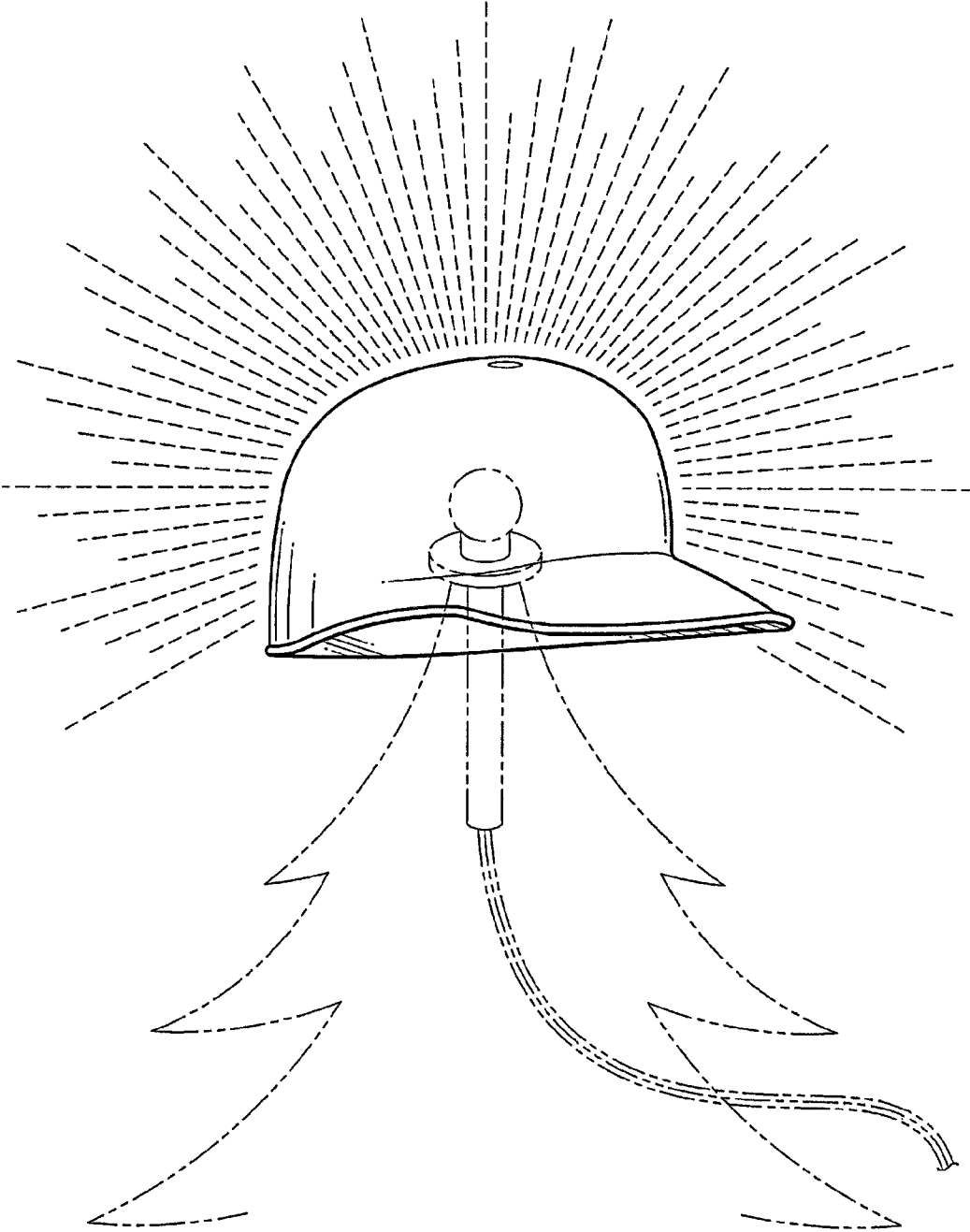

FIG. 1

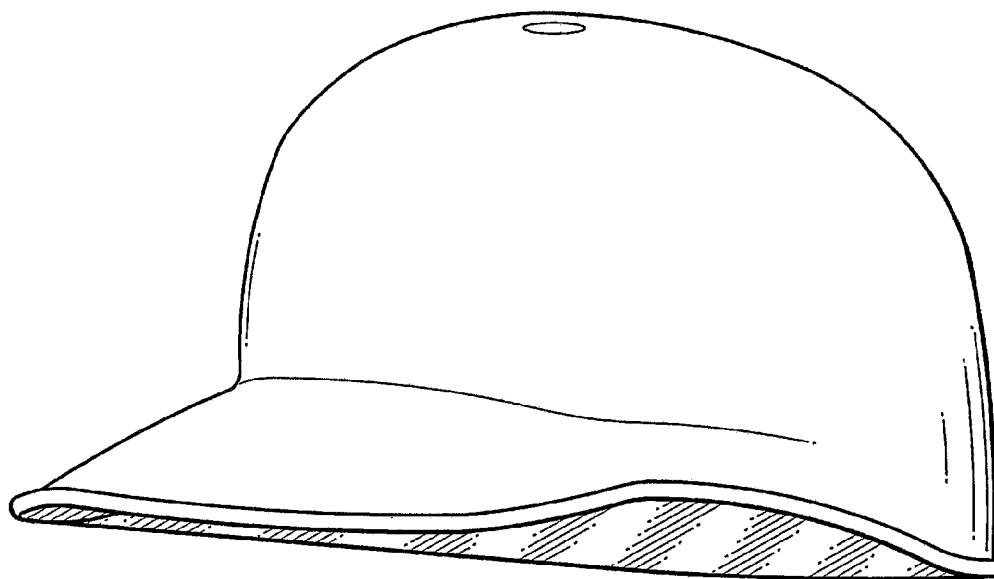

FIG. 2



FIG. 3

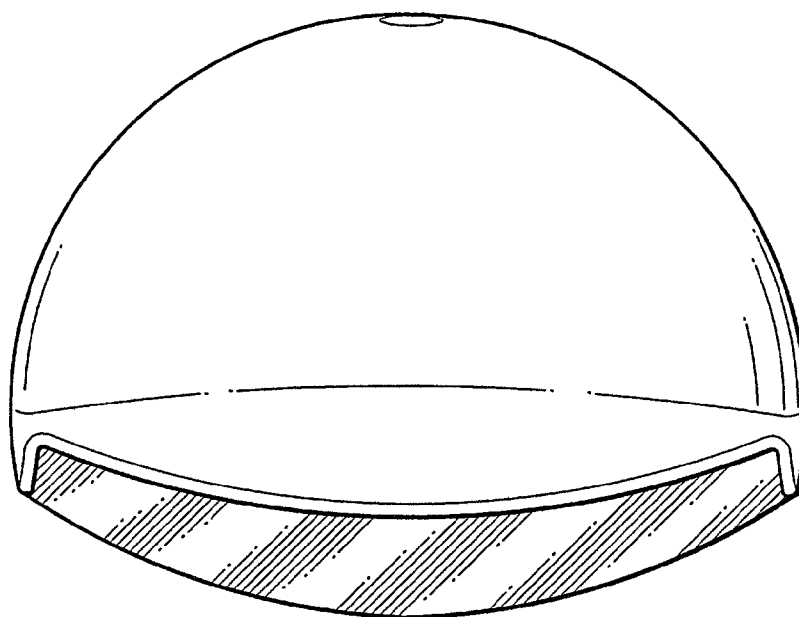

FIG. 4

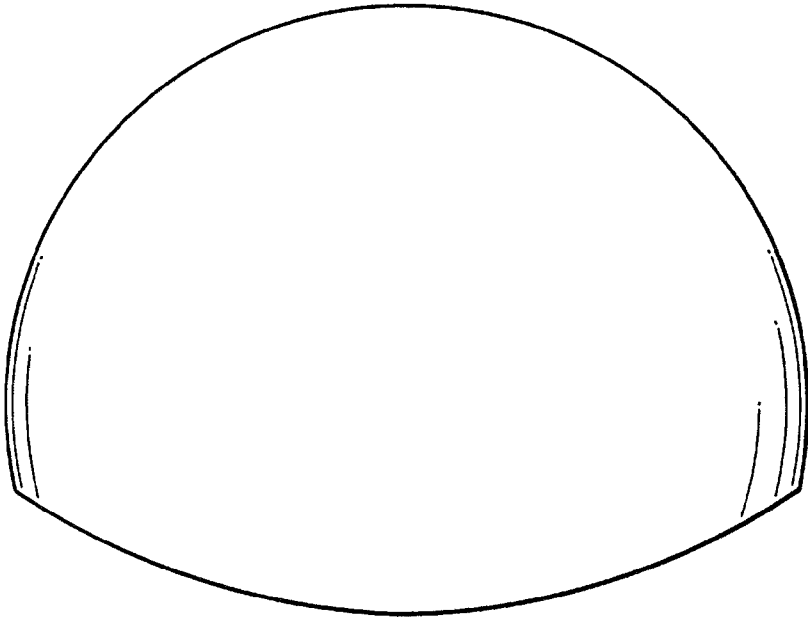

FIG. 5

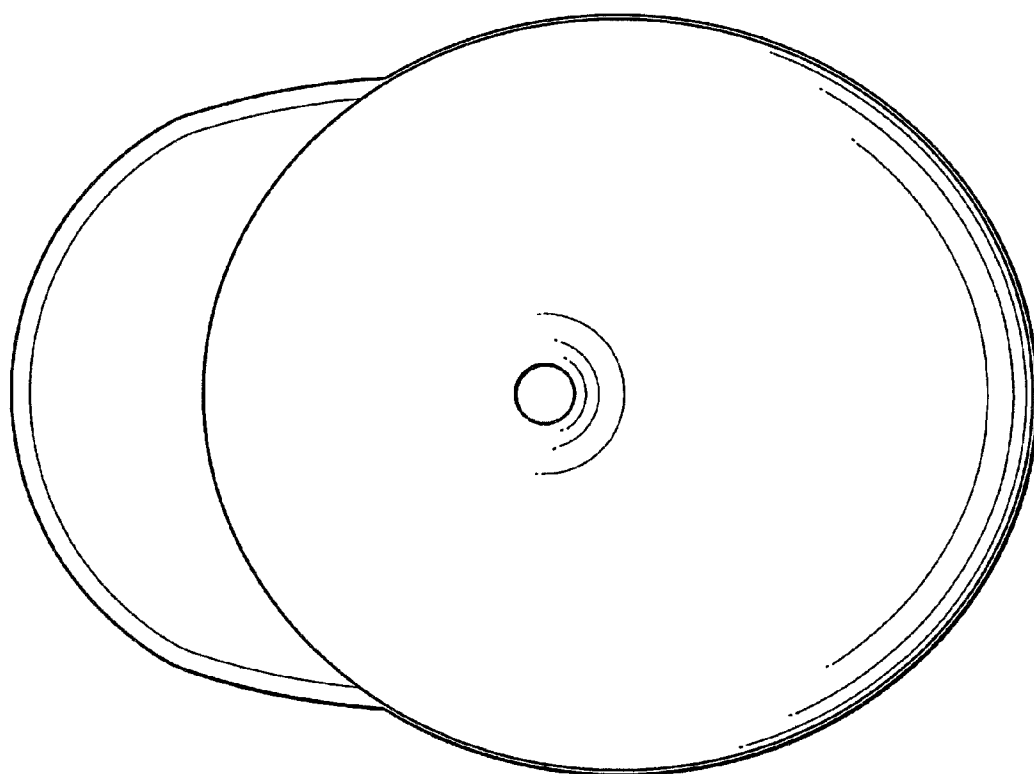

FIG. 6

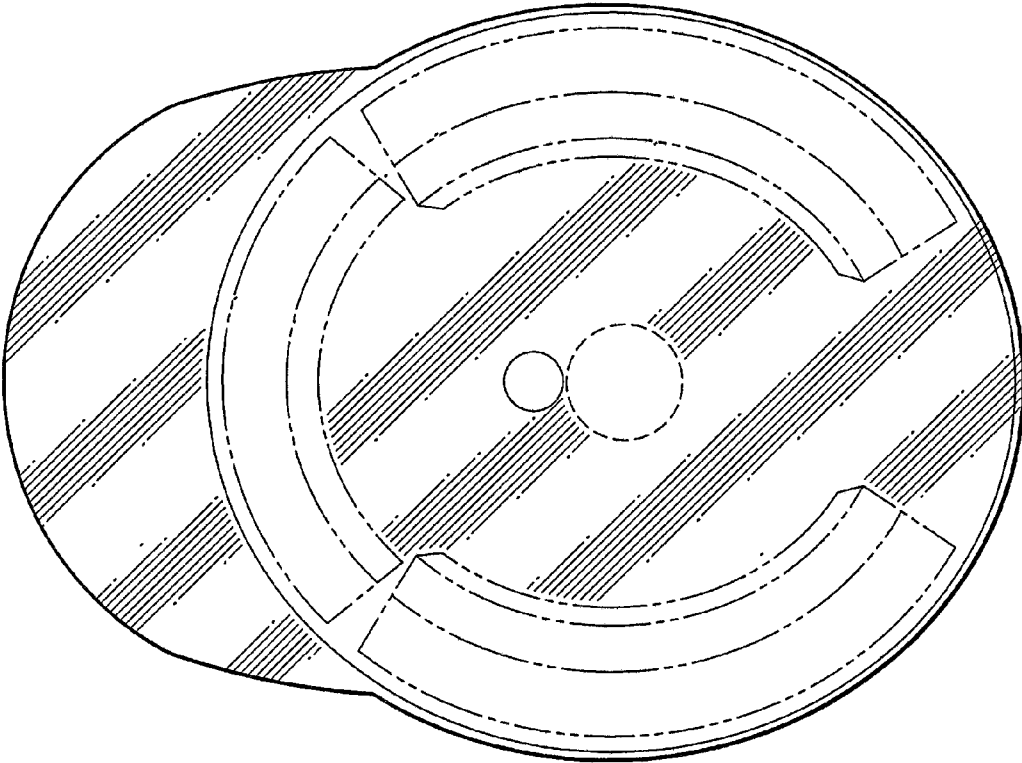

FIG. 7