



US00D720842S

(12) **United States Design Patent**
Chouji et al.

(10) **Patent No.:** **US D720,842 S**

(45) **Date of Patent:** **** Jan. 6, 2015**

(54) **AIR CONDITIONER**

(71) Applicants: **Masahiko Chouji**, Kusatsu (JP);
Kentarou Niki, Kusatsu (JP)

(72) Inventors: **Masahiko Chouji**, Kusatsu (JP);
Kentarou Niki, Kusatsu (JP)

(73) Assignee: **Daikin Industries Ltd.**, Osaka-Shi,
Osaka-Fu (JP)

(**) Term: **14 Years**

(21) Appl. No.: **29/494,341**

(22) Filed: **Jun. 19, 2014**

(51) **LOC (10) Cl.** **23-04**

(52) **U.S. Cl.**

USPC **D23/351**

(58) **Field of Classification Search**

USPC D23/351-354, 385, 355, 357, 361;
312/236; 62/259.1, 259.4, 262-263,
62/304; 454/330-331, 349-350

See application file for complete search history.

(56) **References Cited**

U.S. PATENT DOCUMENTS

D539,889 S *	4/2007	Chooji	D23/351
D550,822 S *	9/2007	Shimizu	D23/351
D553,721 S *	10/2007	Seki et al.	D23/351
D580,037 S *	11/2008	Seki et al.	D23/351
D587,792 S *	3/2009	Lebrun	D23/304
D613,843 S *	4/2010	Ohta	D23/351

D621,491 S *	8/2010	Tsuji	D23/351
D624,167 S *	9/2010	Mishiro et al.	D23/351
D641,854 S *	7/2011	Seki et al.	D23/351
D689,179 S *	9/2013	Nishiguchi	D23/351
D701,295 S *	3/2014	Chouji et al.	D23/351
D709,171 S *	7/2014	Chouji	D23/351

* cited by examiner

Primary Examiner — Brian N Vinson

(74) *Attorney, Agent, or Firm* — Manabu Kanesaka

(57) **CLAIM**

The ornamental design for an air conditioner, as shown and described.

DESCRIPTION

FIG. 1 is a perspective view of an air conditioner showing our new design;

FIG. 2 is a front view thereof;

FIG. 3 is a rear view thereof;

FIG. 4 is a plan view thereof;

FIG. 5 is a bottom view thereof;

FIG. 6 is a left side view thereof;

FIG. 7 is a right side view thereof; and,

FIG. 8 is a cross-sectional view thereof along the line 8-8 in FIG. 2.

The broken lines depict portions of the air conditioner that form no part of claimed design.

1 Claim, 7 Drawing Sheets

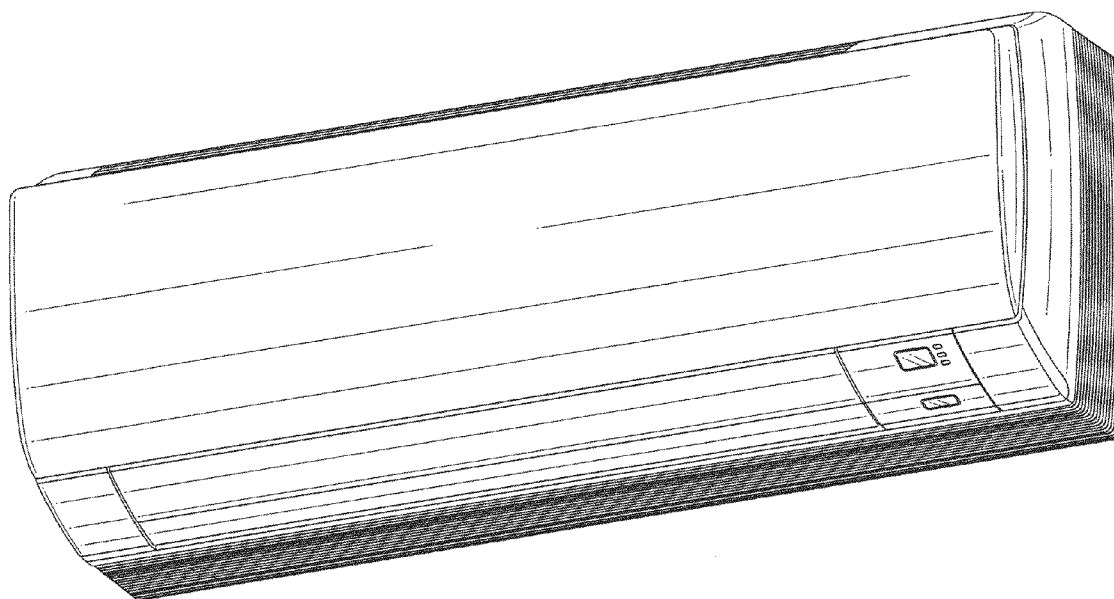

Fig. 1

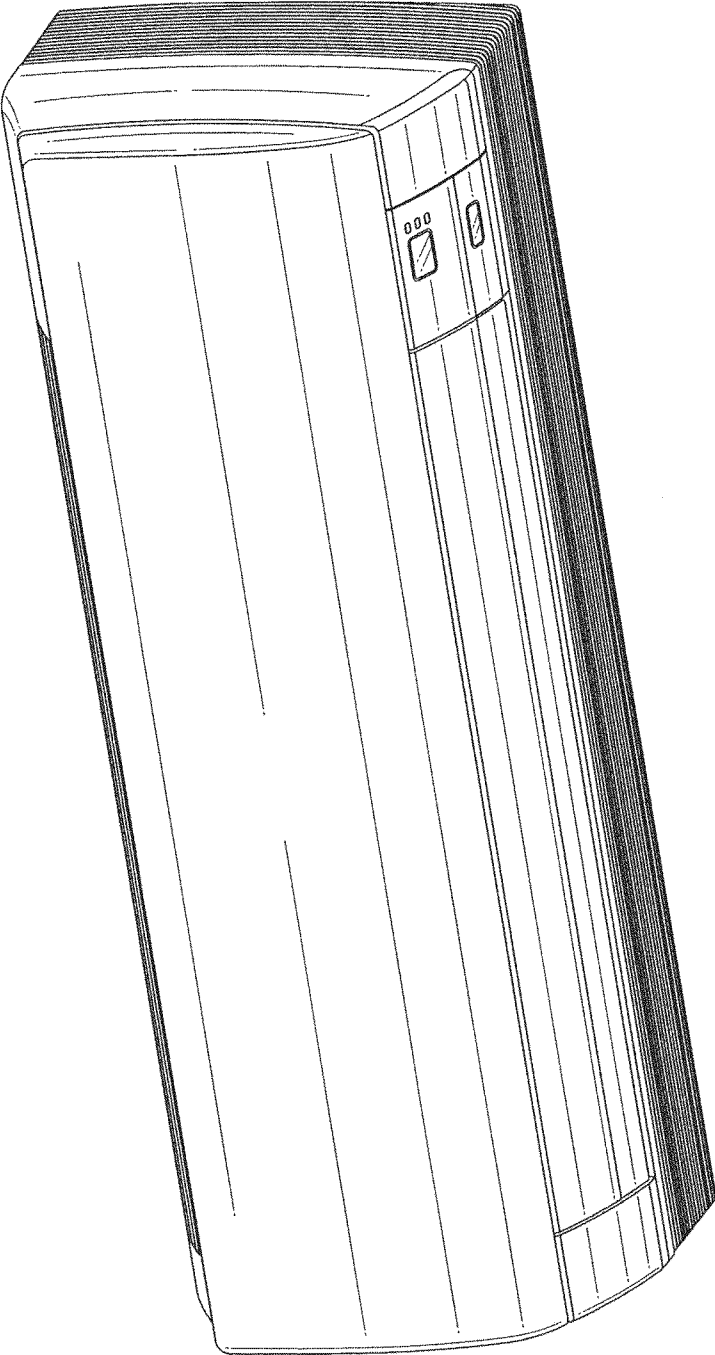

Fig. 2

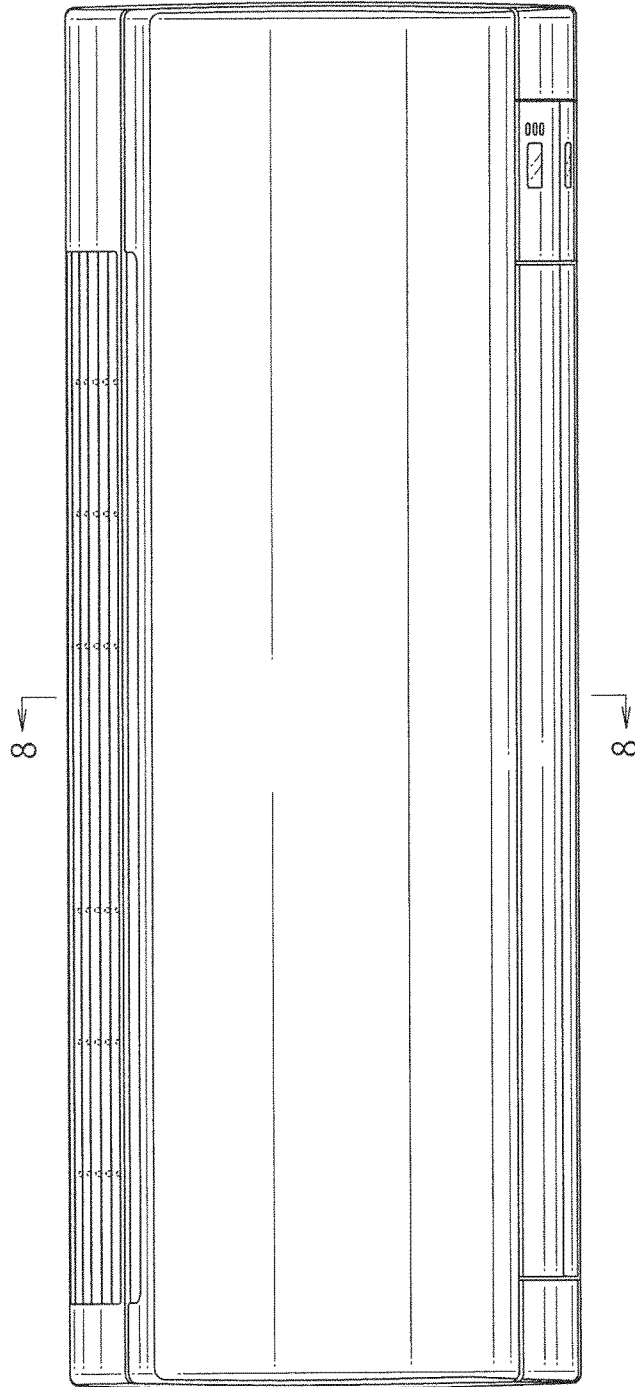

Fig. 3

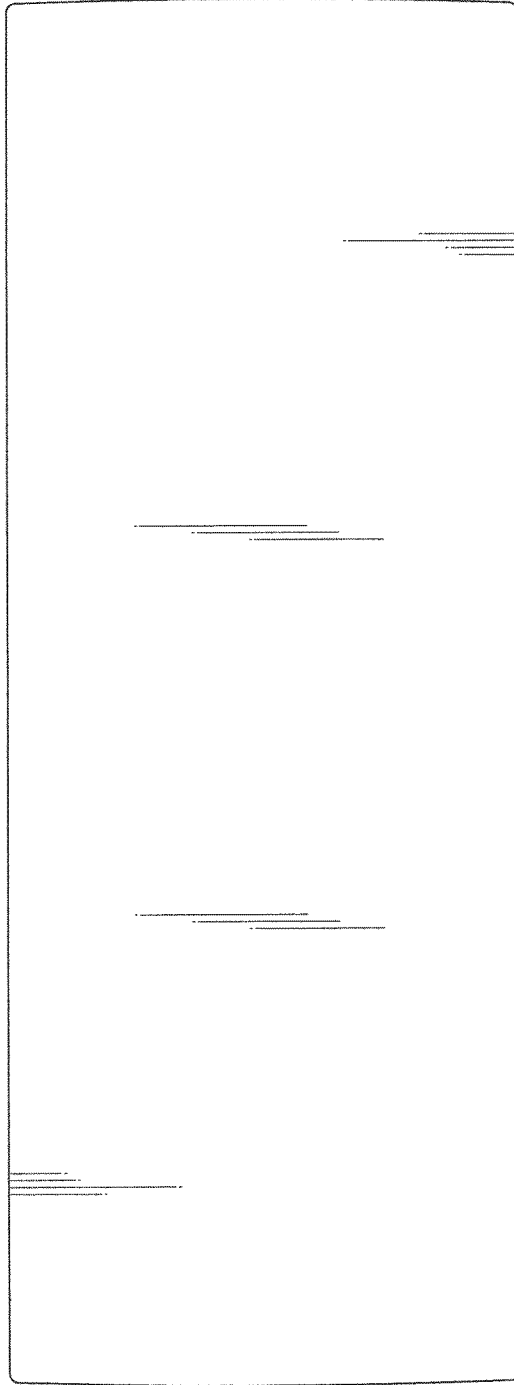

Fig. 4

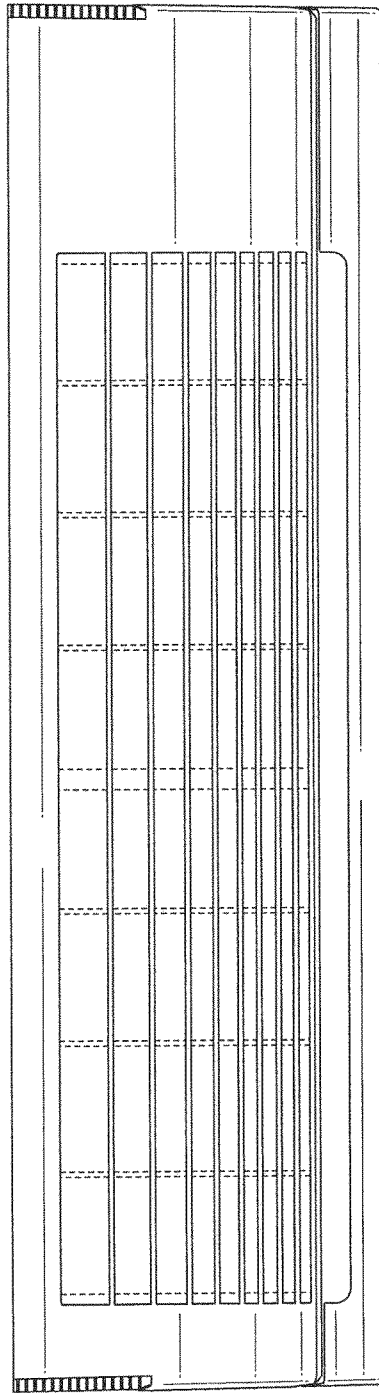

Fig. 5

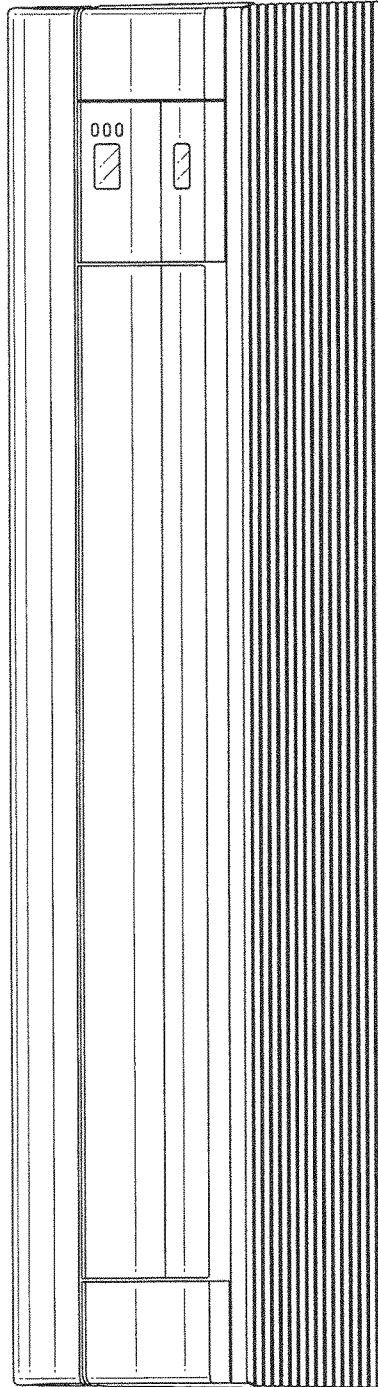

Fig. 7

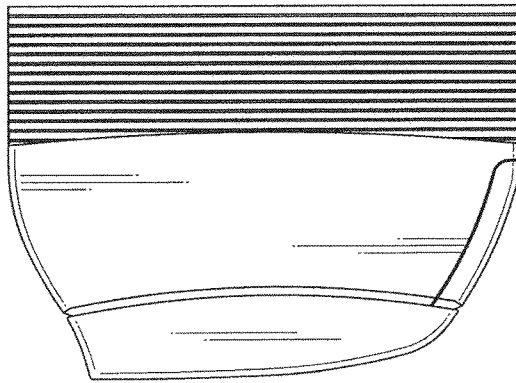

Fig. 6

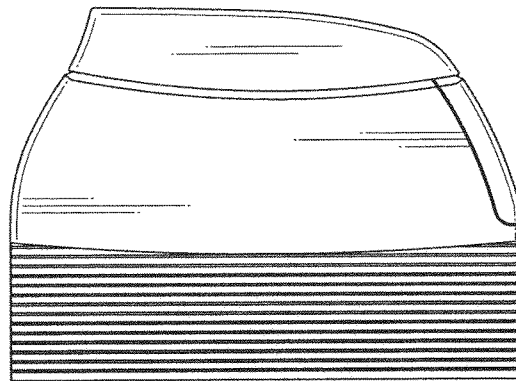

Fig. 8

