



US0D1017396S

(12) **United States Design Patent**  
**Safdie et al.**

(10) **Patent No.:** **US D1,017,396 S**

(45) **Date of Patent:** **\*\* Mar. 12, 2024**

(54) **PACKAGE FOR PERSONAL CARE ARTICLES**

D420,917 S \* 2/2000 Dolce ..... D9/417  
D524,655 S \* 7/2006 Baez ..... D9/782  
D525,522 S \* 7/2006 Kohlweyer ..... D9/529  
D668,144 S \* 10/2012 Swart ..... D9/430

(Continued)

(71) Applicant: **Best Accessory Group LLC**, New York, NY (US)

(72) Inventors: **Abraham Safdie**, Brooklyn, NY (US);  
**Jack Saban**, Brooklyn, NY (US)

FOREIGN PATENT DOCUMENTS

CN 303284687 \* 7/2015  
CN 307678027 \* 11/2022

(Continued)

(73) Assignee: **Best Accessory Group LLC**, New York, NY (US)

(\*\*) Term: **15 Years**

OTHER PUBLICATIONS

(21) Appl. No.: **29/815,088**

#22 Free Skate Long Hexagon Gift Box Tutorial. Date posted: Dec. 13, 2019. Site visited: Aug. 31, 2023. Available online: <https://www.intatwinedesigns.co.uk/crafty-christmas-countdown-22-free-skate-long-hexagon-gift-box-tutorial/> (Year: 2019).\*

(Continued)

(22) Filed: **Nov. 11, 2021**

(51) **LOC (14) Cl.** ..... **09-03**

(52) **U.S. Cl.**  
USPC ..... **D9/431**

(58) **Field of Classification Search**  
USPC ..... D9/431, 430, 432, 433, 766, 768, 782, D9/528, 575, 445, 563, 771, 414, 417, D9/421, 529; D3/203.5, 203.6, 203.8, D3/203.3, 205, 200, 201, 203.1, 203.2; D28/76, 82, 7, 91, 77, 8, 9; D7/533, 536, D7/543, 300, 600, 622, 394, 515, 615, D7/629; D24/108, 121, 156, 176; D99/5  
CPC ..... B65D 5/00; B65D 5/001; B65D 5/0015; B65D 5/0227; B65D 5/0254; B65D 5/18; B65D 5/6605; B65D 5/48024; B65D 5/3614; B65D 85/00; B65D 1/00; B65D 1/023; B65D 1/0223; B65D 1/18; B65D 1/02

See application file for complete search history.

*Primary Examiner* — Catherine S Posthauer

*Assistant Examiner* — Joan E. Diehl

(74) *Attorney, Agent, or Firm* — Dorton & Willis, LLP

(57) **CLAIM**

The ornamental design for a package for personal care articles, as shown and described.

**DESCRIPTION**

FIG. 1 is a front perspective view of our new package for personal care articles design;  
FIG. 2 is a front elevation view thereof;  
FIG. 3 is a rear elevation view thereof;  
FIG. 4 is a right-side elevation view thereof;  
FIG. 5 is a left-side elevation view thereof;  
FIG. 6 is a top plan view thereof; and,  
FIG. 7 is a bottom plan view thereof.  
The broken dash lines shown in the drawing views illustrate portions of the package for personal care articles that form no part of the claimed design.

**1 Claim, 7 Drawing Sheets**

(56) **References Cited**

U.S. PATENT DOCUMENTS

D30,428 S \* 3/1899 Hamburger ..... D9/431  
3,174,675 A \* 3/1965 Rosenberg, Jr. .... B65D 5/3614  
229/110  
D395,123 S \* 6/1998 Barretto ..... D99/5

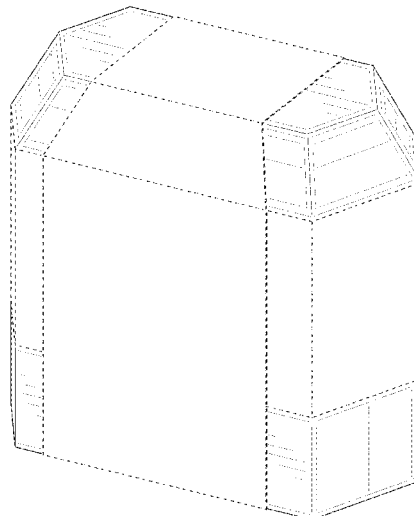

(56)

**References Cited**

U.S. PATENT DOCUMENTS

D683,212 S \* 5/2013 Kolton ..... D9/430  
D795,689 S \* 8/2017 Shirosawa ..... D9/421  
D805,893 S \* 12/2017 Shirosawa ..... D9/433  
D907,483 S \* 1/2021 Johnson ..... D9/430  
2006/0180642 A1 \* 8/2006 Zacher ..... B65D 5/0227  
229/109

FOREIGN PATENT DOCUMENTS

DE 2641791 A1 \* 3/1978  
KR 20070065188 A \* 6/2007

OTHER PUBLICATIONS

Commercial Zone Hexagonal Waste Container. Date first available:  
Jun. 15, 2017. Site visited: Aug. 31, 2023. Available online: [https://  
www.webstaurantstore.com/commercial-zone-737102-polytec-30-  
gallon-beige-hexagonal-waste-container-with-open-top/278737102-  
html](https://www.webstaurantstore.com/commercial-zone-737102-polytec-30-gallon-beige-hexagonal-waste-container-with-open-top/278737102.html) (Year: 2017).\*

\* cited by examiner

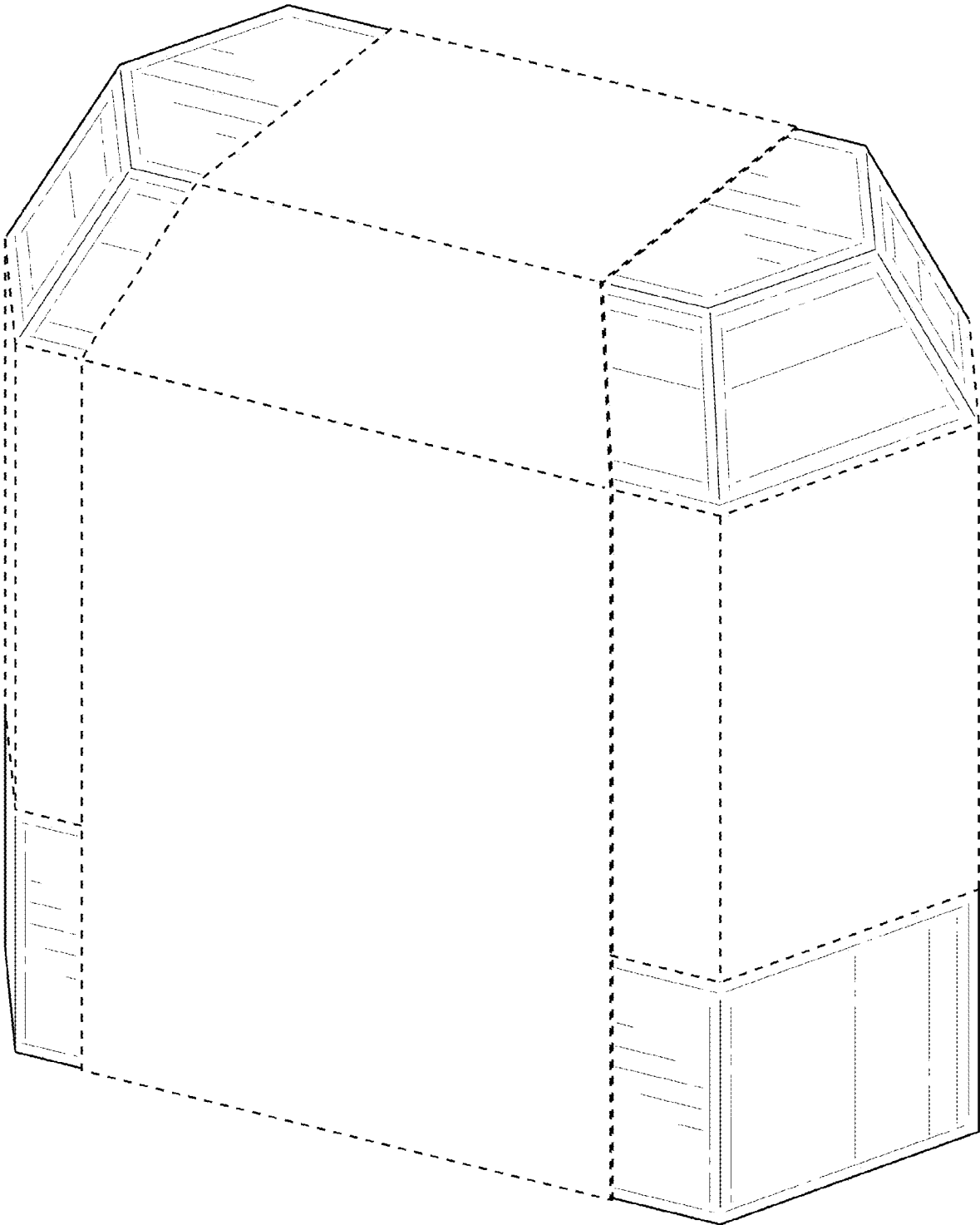

**FIG. 1**

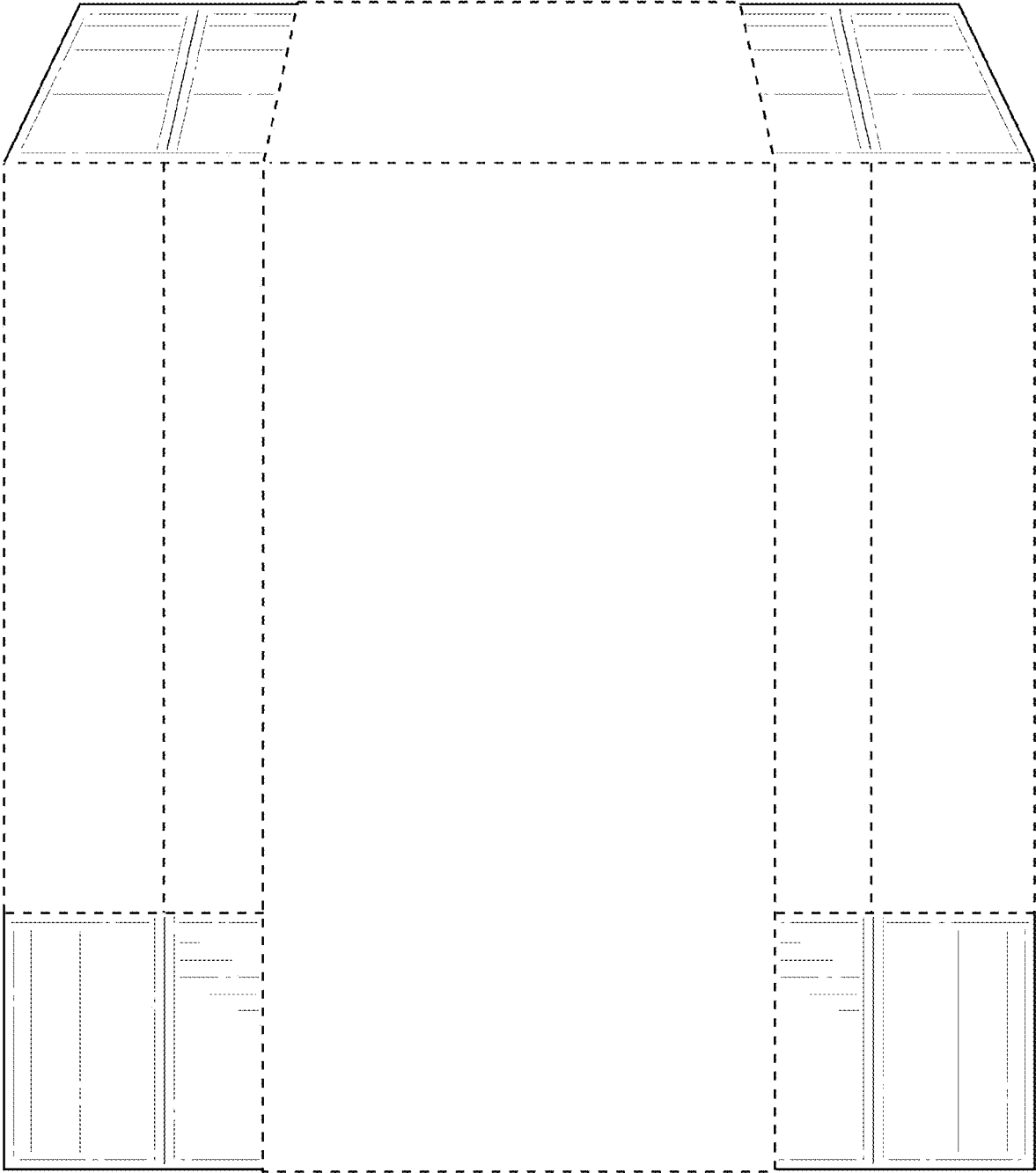

**FIG. 2**

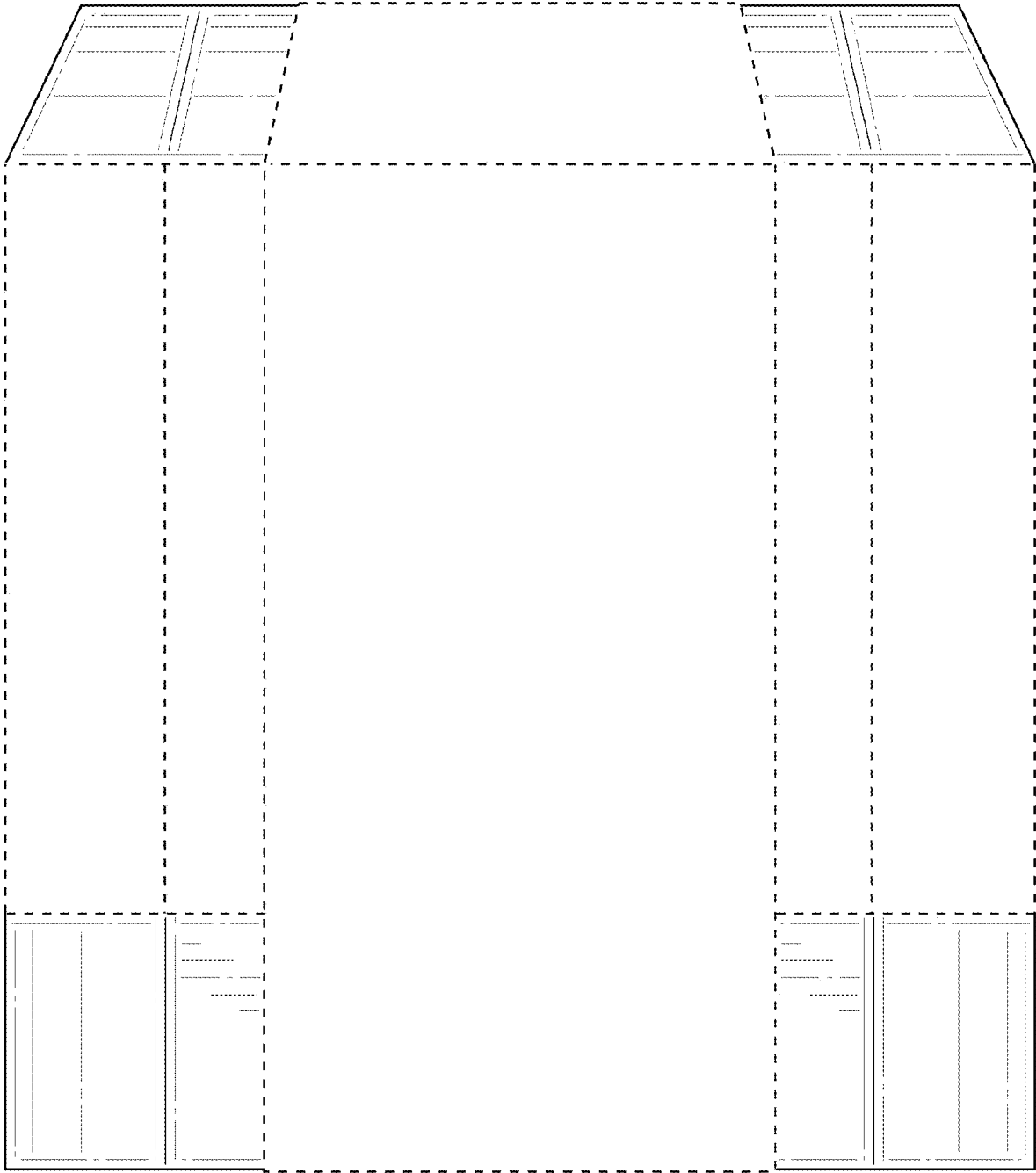

**FIG. 3**

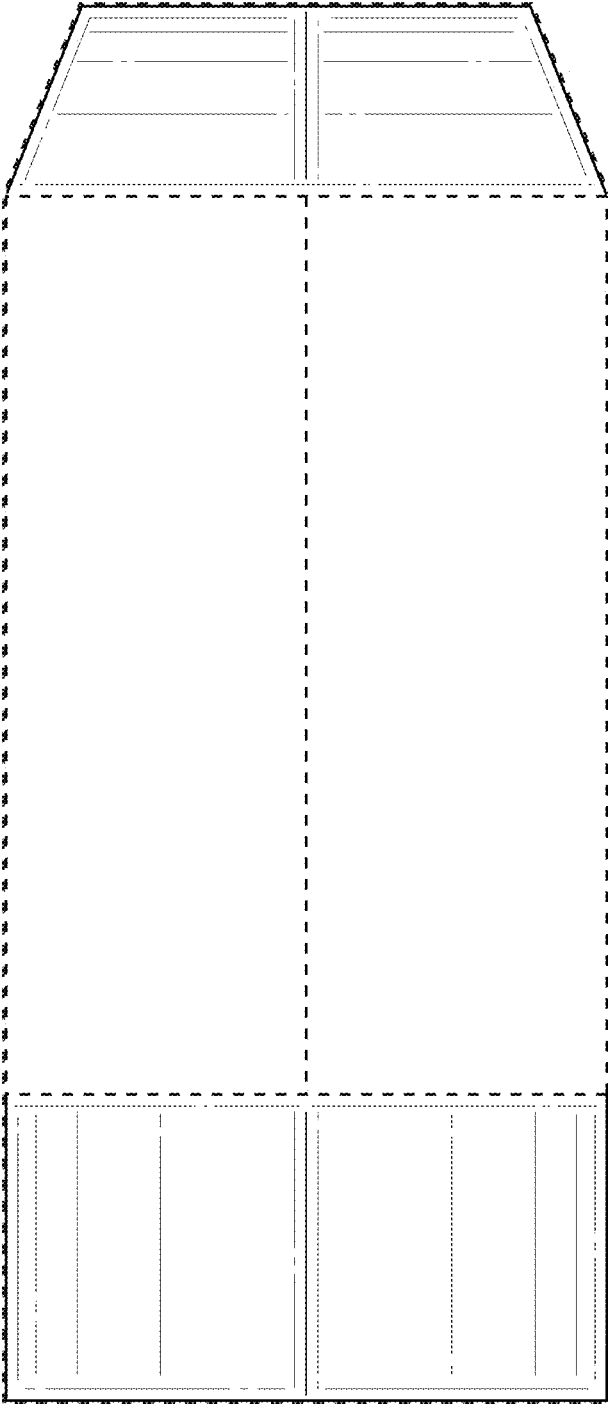

**FIG. 4**

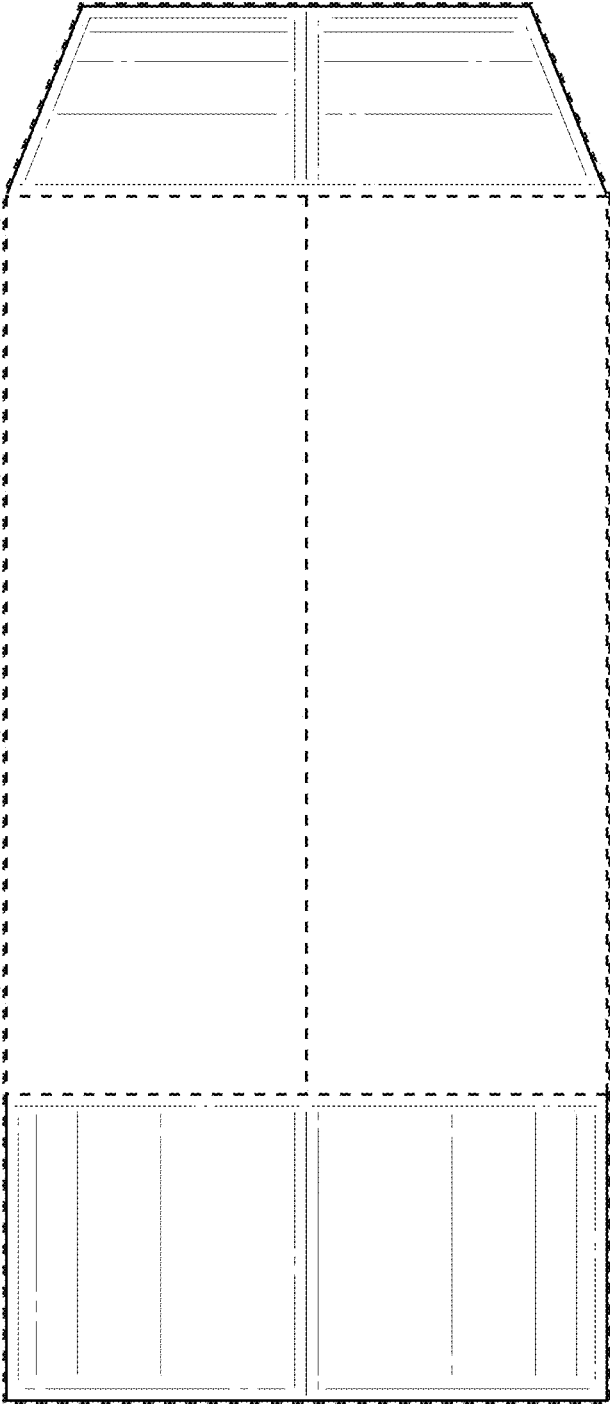

**FIG. 5**

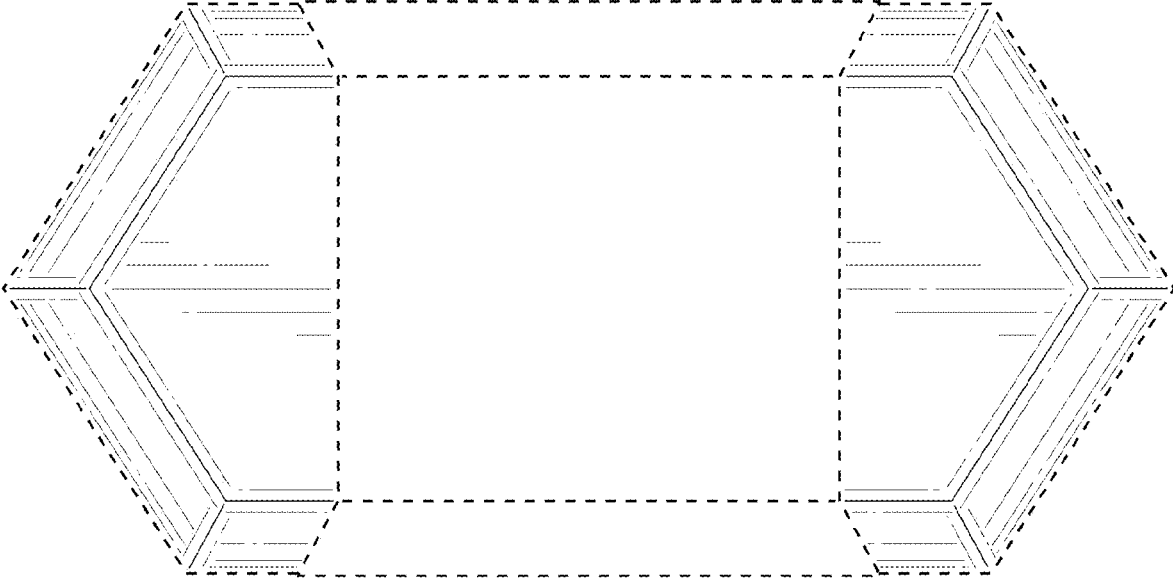

**FIG. 6**

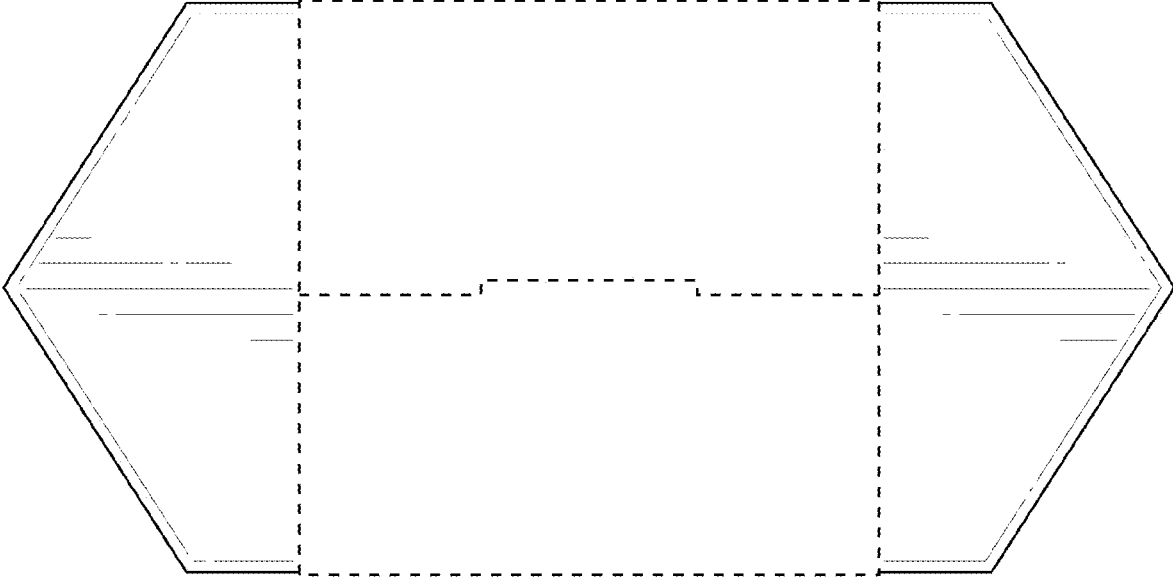

**FIG. 7**