



US00D851432S

(12) **United States Design Patent**
Salto

(10) **Patent No.:** **US D851,432 S**

(45) **Date of Patent:** **** Jun. 18, 2019**

(54) **TABLE**

(71) Applicant: **Fritz Hansen A/S**, Allerød (DK)

(72) Inventor: **Kasper Salto**, Copenhagen K (DK)

(73) Assignee: **Fritz Hansen A/S**, Allerød (DK)

(**) Term: **15 Years**

(21) Appl. No.: **29/570,768**

(22) Filed: **Jul. 12, 2016**

(51) **LOC (11) Cl.** **06-03**

(52) **U.S. Cl.**
USPC **D6/691**

(58) **Field of Classification Search**
USPC D6/641, 656, 685, 690, 691, 691.1–691.9
CPC A47B 7/00; A47B 11/00; A47B 13/00;
A47B 13/02; A47B 13/08; A47B 21/00;
A47B 2200/0011; A47B 2200/0016
See application file for complete search history.

(56) **References Cited**

U.S. PATENT DOCUMENTS

3,228,359	A *	1/1966	Rich, Jr.	F16B 12/48
					108/156
D455,918	S *	4/2002	Moore	D6/691.6
D503,298	S *	3/2005	Juneau	D6/691
D508,625	S *	8/2005	Frenkler	D6/647
D732,852	S *	6/2015	Park	D6/656
D775,876	S *	1/2017	Gaschy	D6/691
D781,085	S *	3/2017	Liu	F16B 12/48
					D6/691
D788,503	S *	6/2017	Duvigneau	D6/691.6
D799,248	S *	10/2017	Miller	D6/691

* cited by examiner

Primary Examiner — Mary Ann Calabrese

(74) *Attorney, Agent, or Firm* — Renner, Otto, Boisselle & Sklar, LLP

(57) **CLAIM**

The ornamental design for a table, as shown and described.

DESCRIPTION

FIG. 1 is a front, top, left perspective view of a first embodiment of a table showing my new design;
 FIG. 2 is a top plan view thereof;
 FIG. 3 is a bottom plan view thereof;
 FIG. 4 is a front elevational view thereof;
 FIG. 5 is a left side elevational view thereof;
 FIG. 6 is a rear elevational view thereof; and
 FIG. 7 is a right side elevational view thereof;
 FIG. 8 is a front, top, left perspective view of a second embodiment of a table showing my new design;
 FIG. 9 is a top plan view thereof;
 FIG. 10 is a bottom plan view thereof;
 FIG. 11 is a front elevational view thereof;
 FIG. 12 is a left side elevational view thereof;
 FIG. 13 is a rear elevational view thereof; and
 FIG. 14 is a right side elevational view thereof;
 FIG. 15 is a front, top, right perspective view of a third embodiment of a table showing my new design;
 FIG. 16 is a top plan view thereof;
 FIG. 17 is a bottom plan view thereof;
 FIG. 18 is a front elevational view thereof;
 FIG. 19 is a left side elevational view thereof;
 FIG. 20 is a rear elevational view thereof; and
 FIG. 21 is a right side elevational view thereof;
 FIG. 22 is a front, top, left perspective view of a fourth embodiment of a table showing my new design;
 FIG. 23 is a top plan view thereof;
 FIG. 24 is a bottom plan view thereof;
 FIG. 25 is a front elevational view thereof;
 FIG. 26 is a left side elevational view thereof;
 FIG. 27 is a rear elevational view thereof; and
 FIG. 28 is a right side elevational view thereof.

The broken line showing is for the purpose of illustrating unclaimed portions of the article and forms no part of the claimed design.

1 Claim, 28 Drawing Sheets

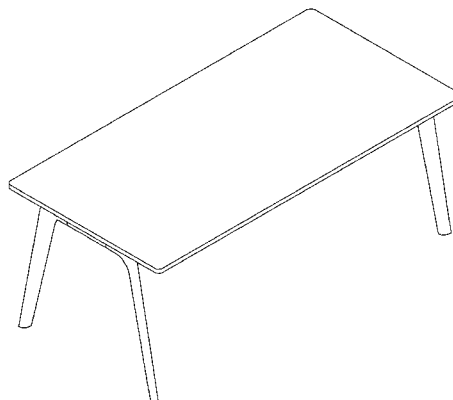

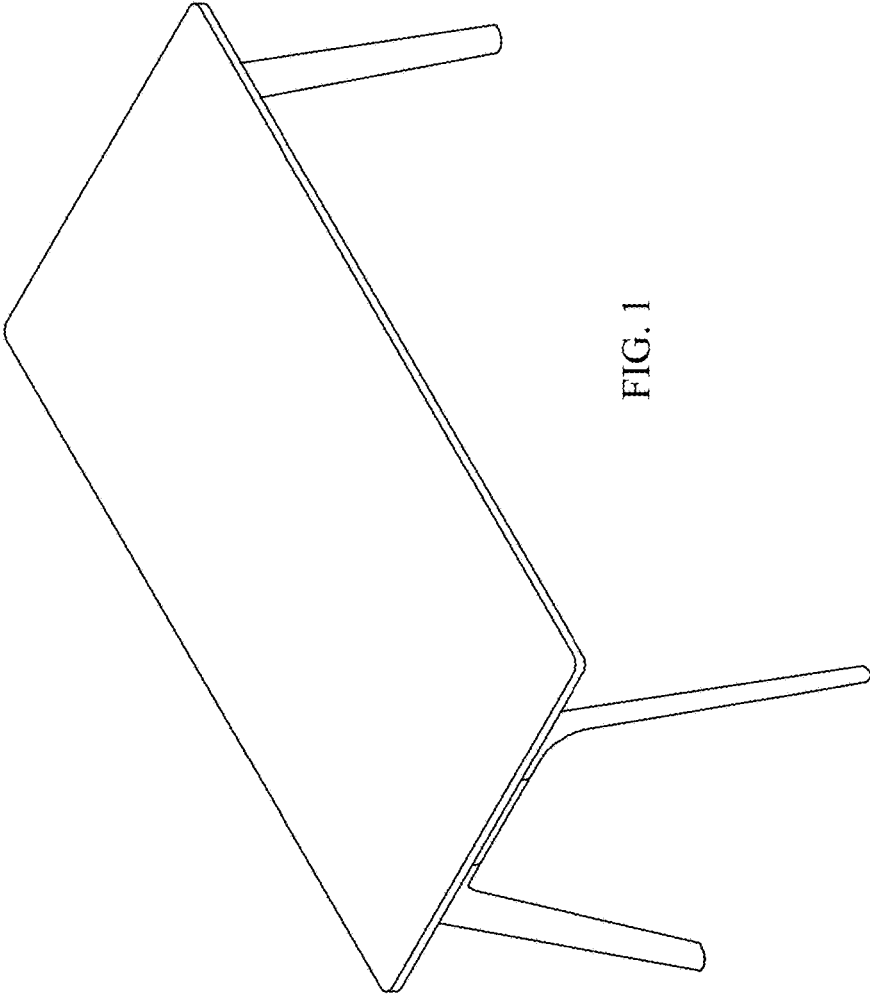

FIG. 1

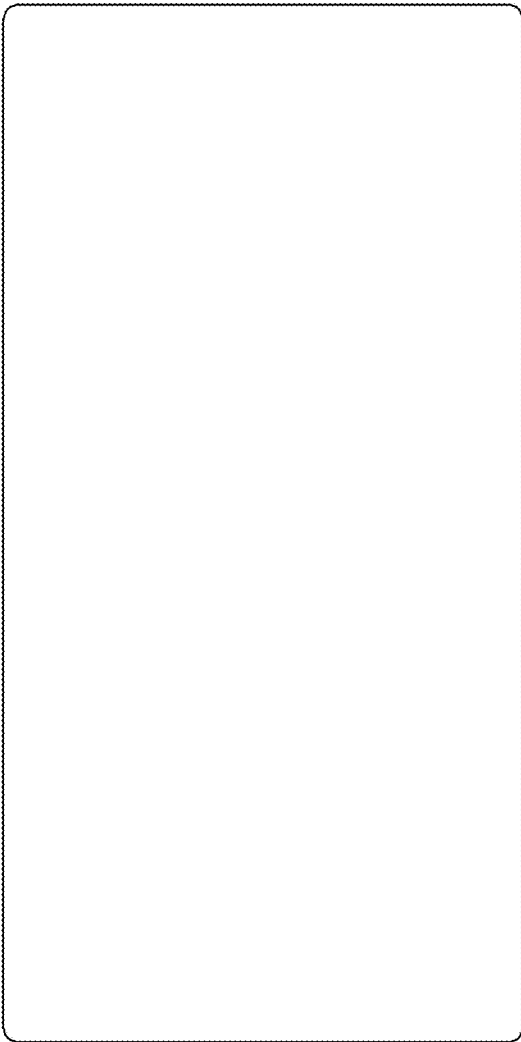

FIG. 2

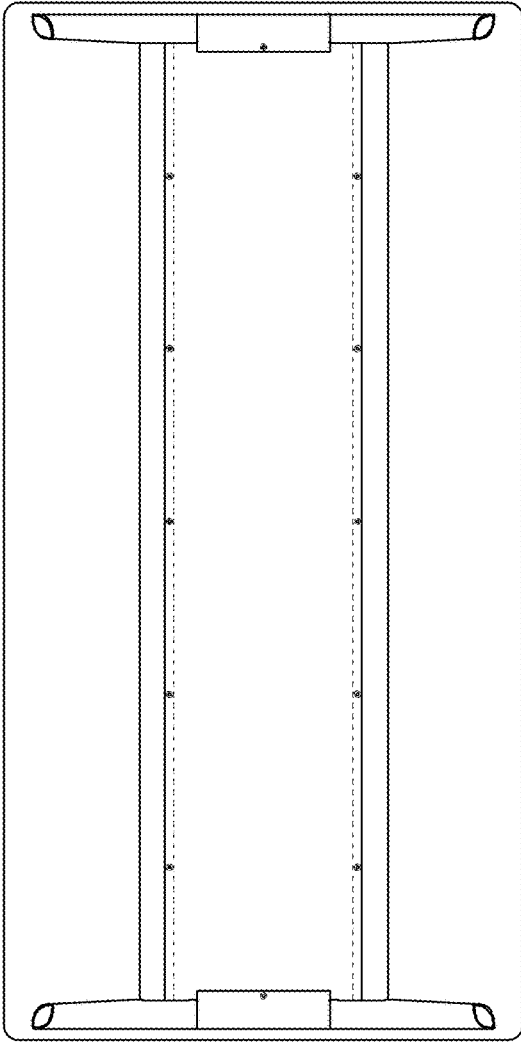

FIG. 3

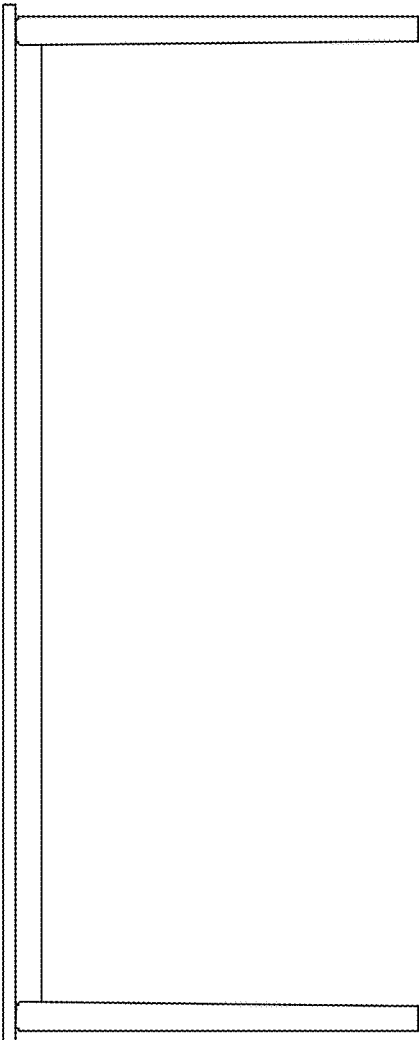

FIG. 4

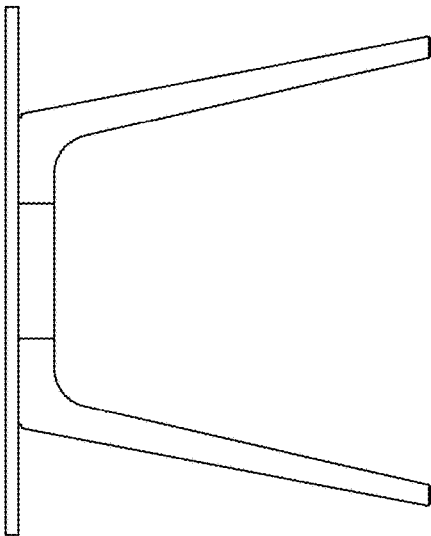

FIG. 5

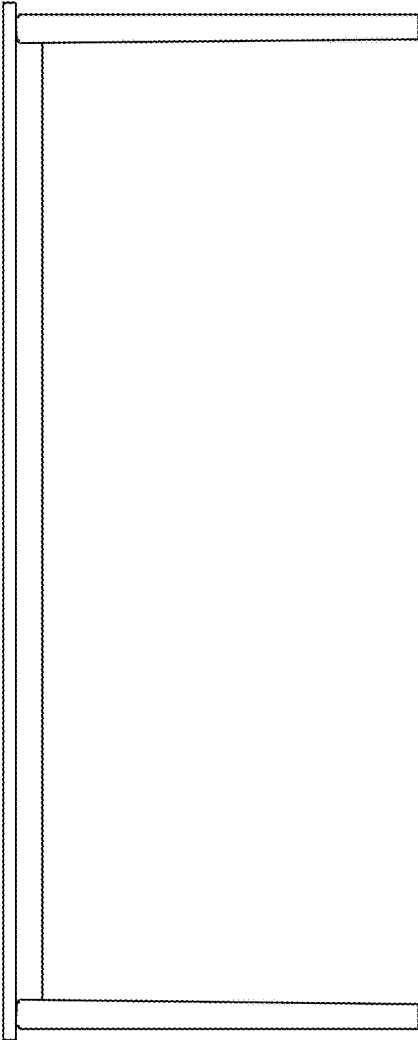

FIG. 6

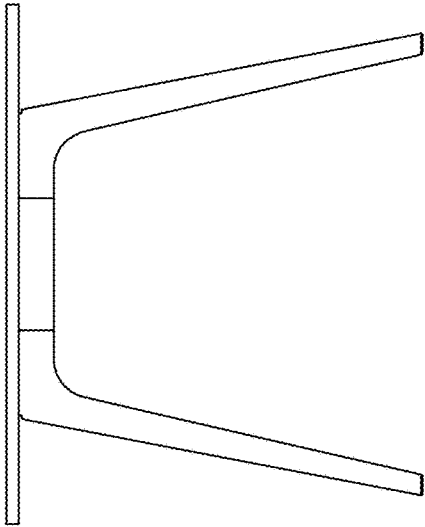

FIG. 7

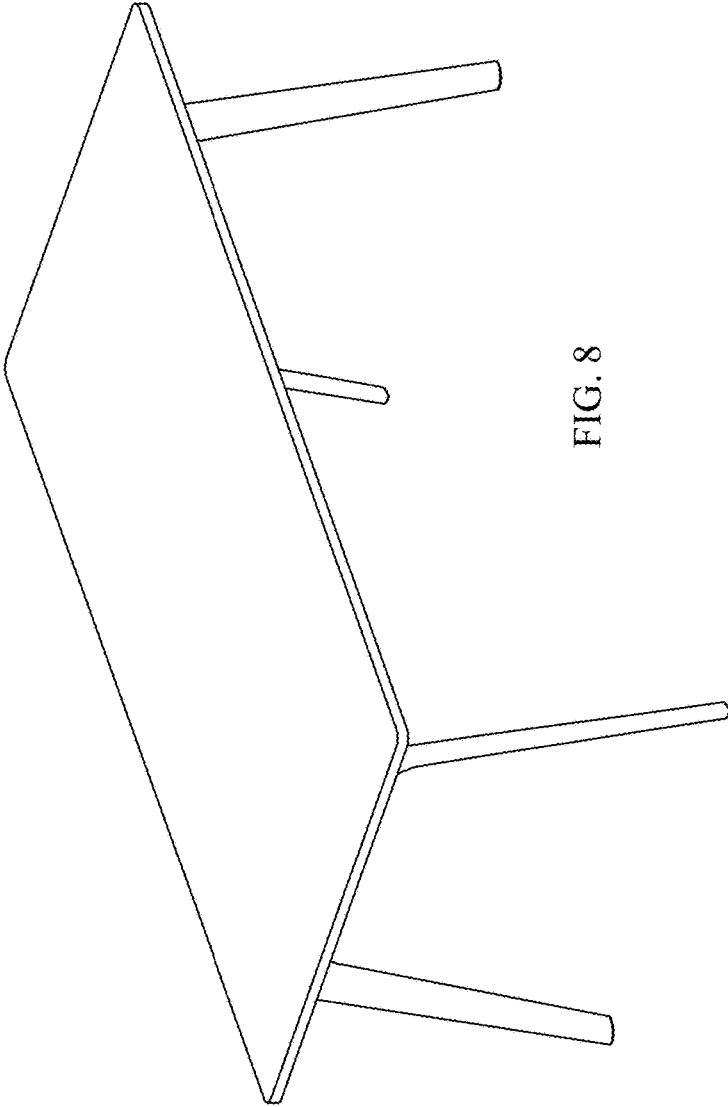

FIG. 8

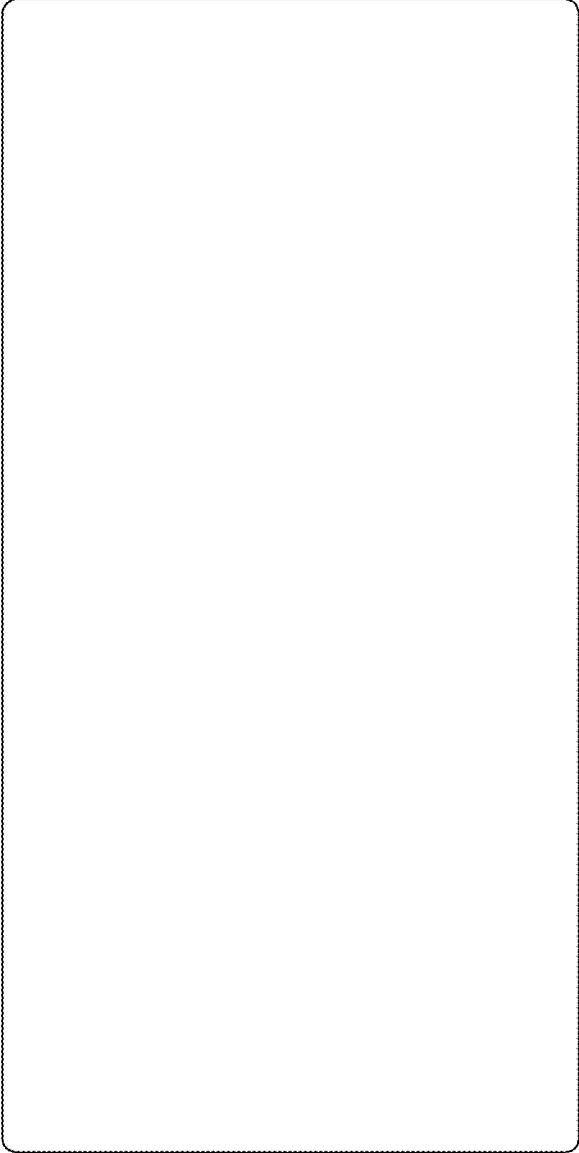

FIG. 9

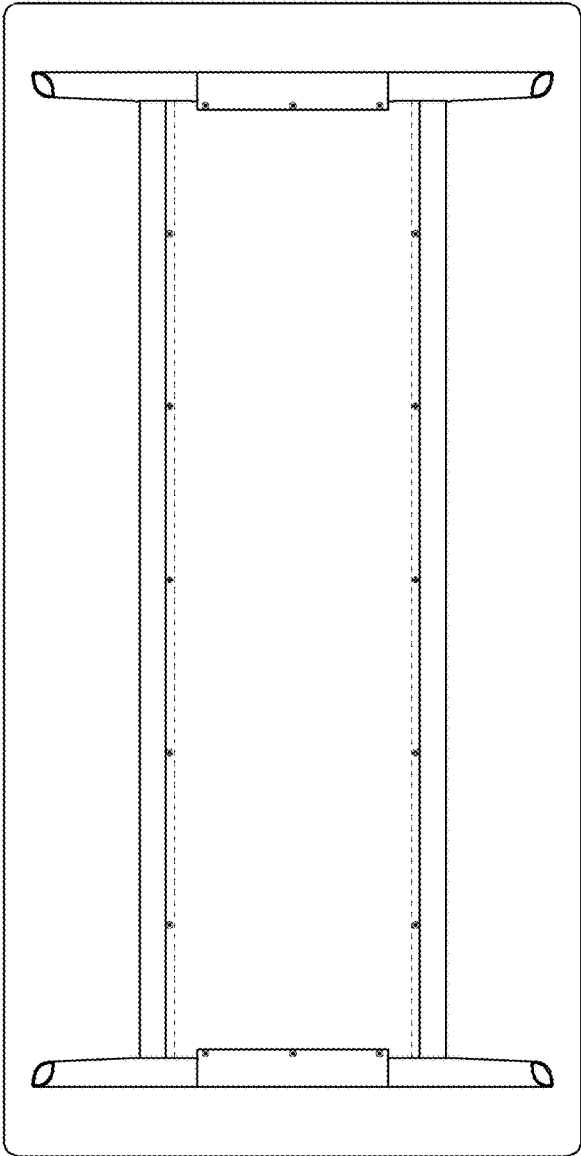

FIG. 10



FIG. 11

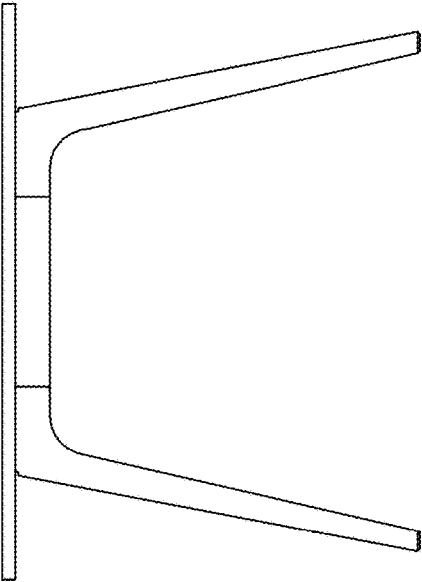

FIG. 12

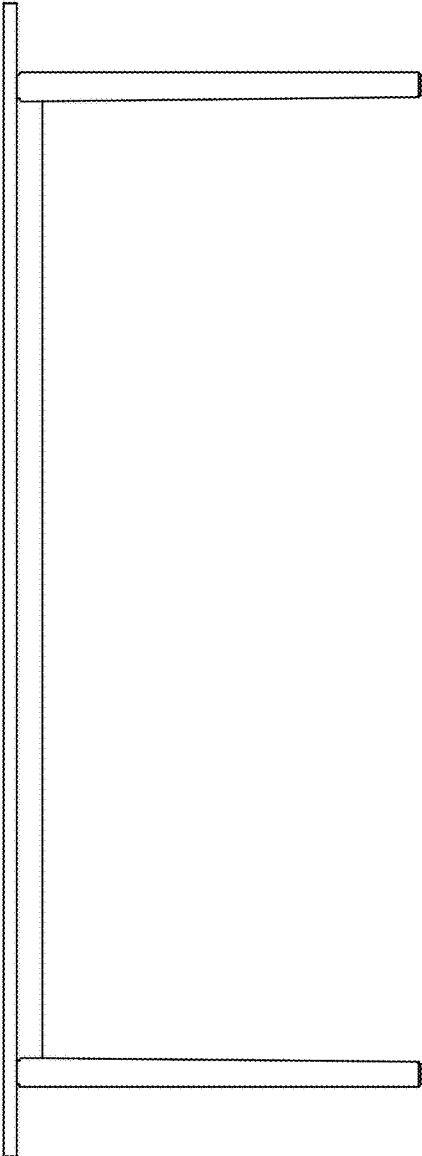

FIG. 13

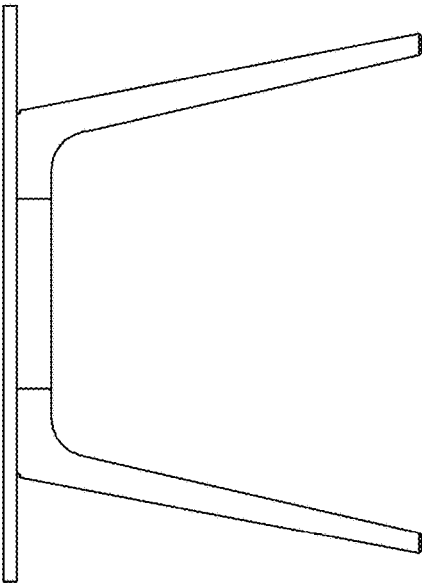

FIG. 14

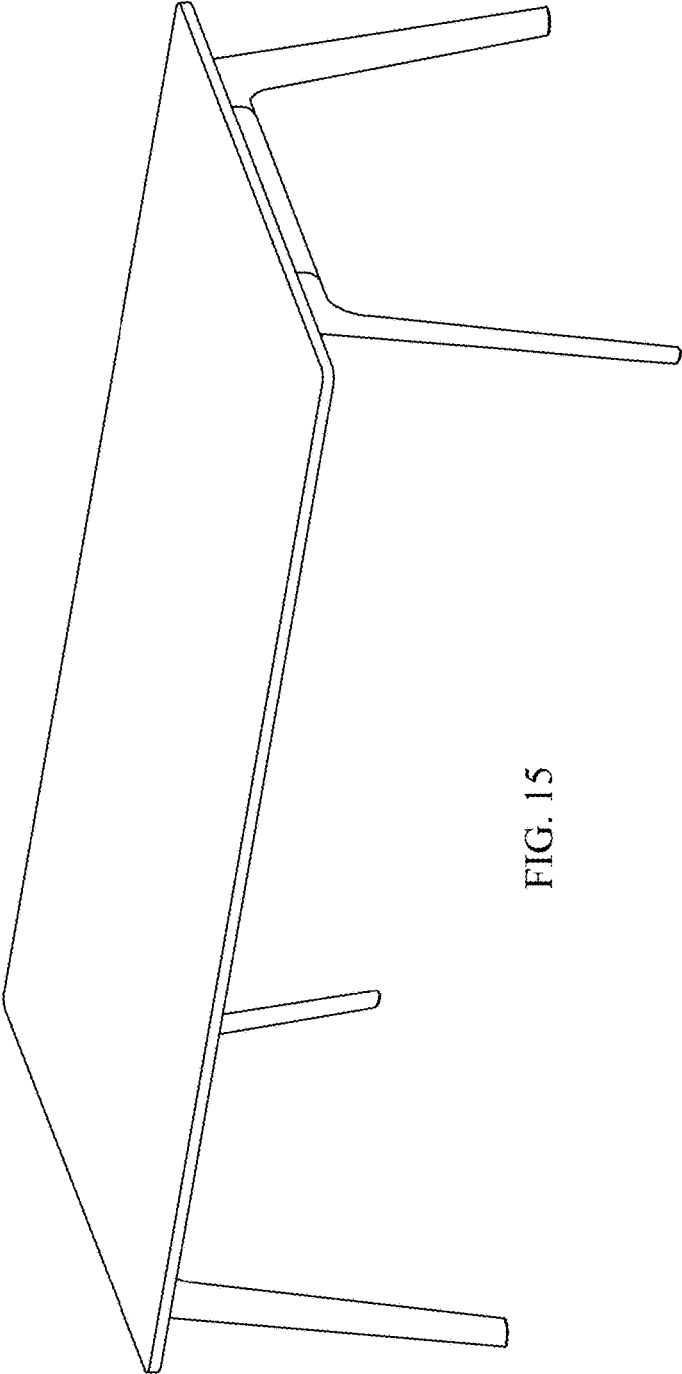

FIG. 15

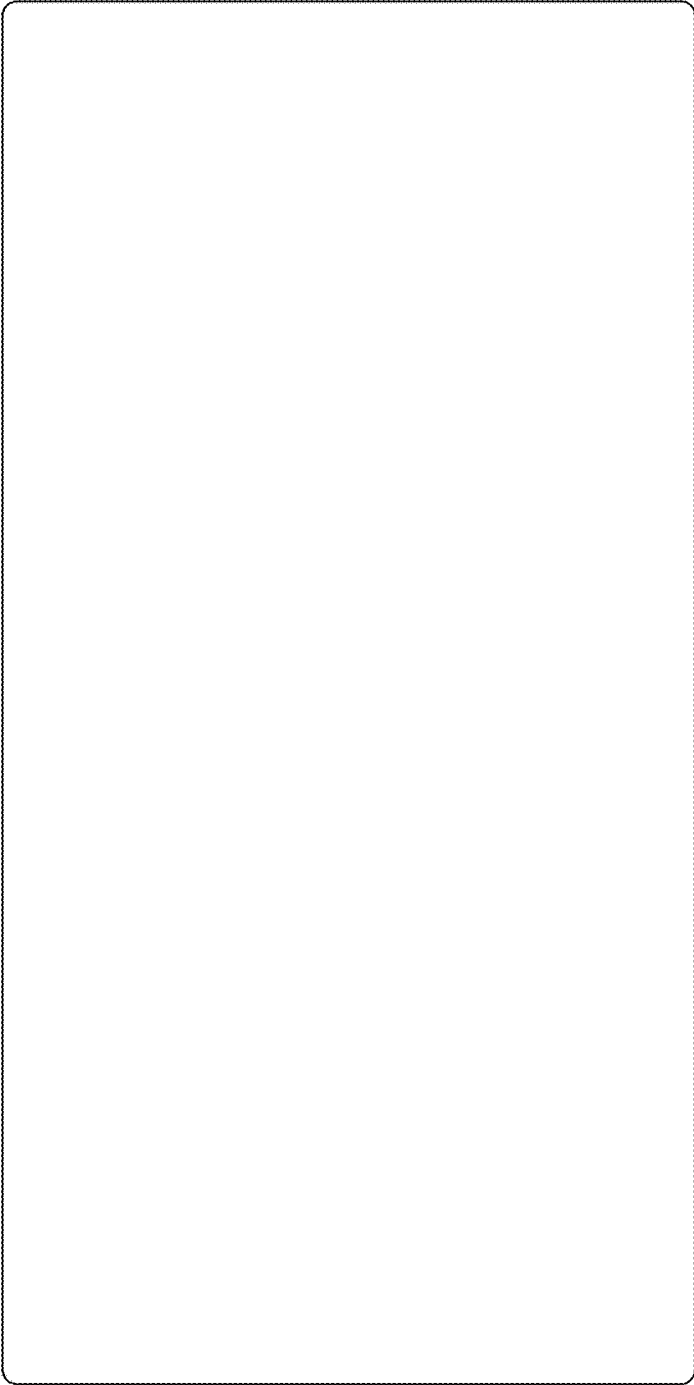

FIG. 16

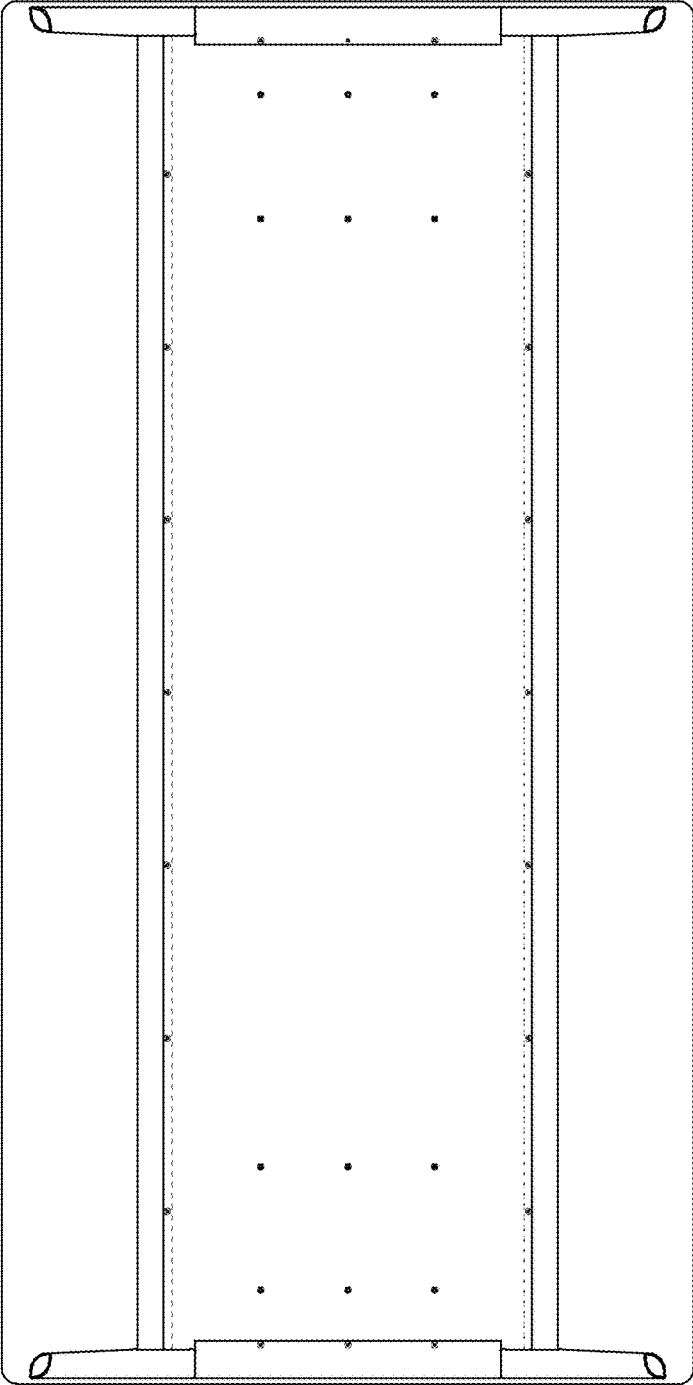

FIG. 17

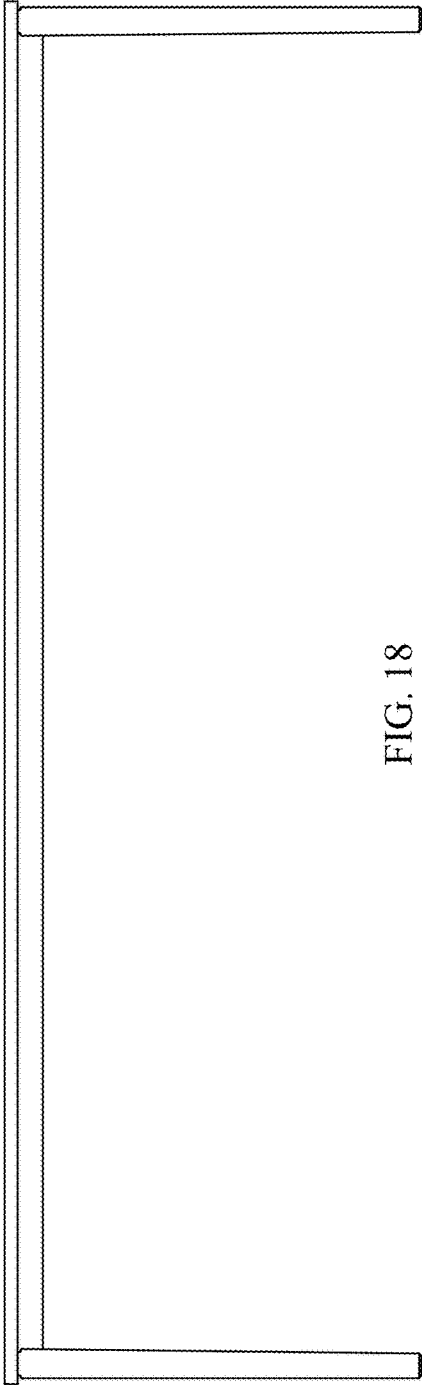

FIG. 18

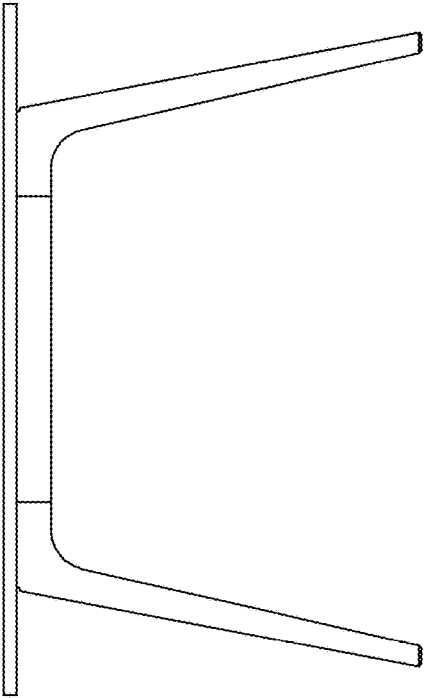

FIG. 19

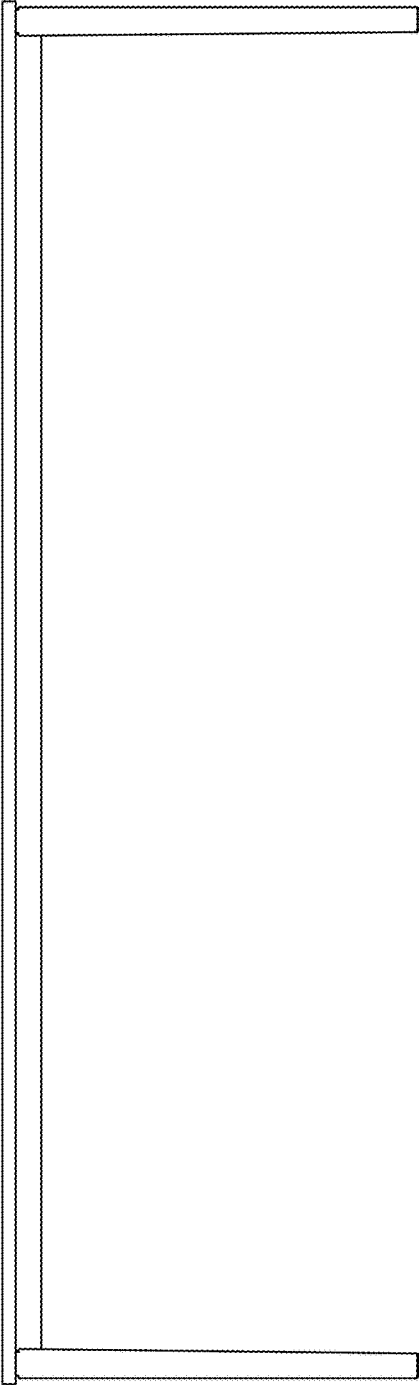

FIG. 20

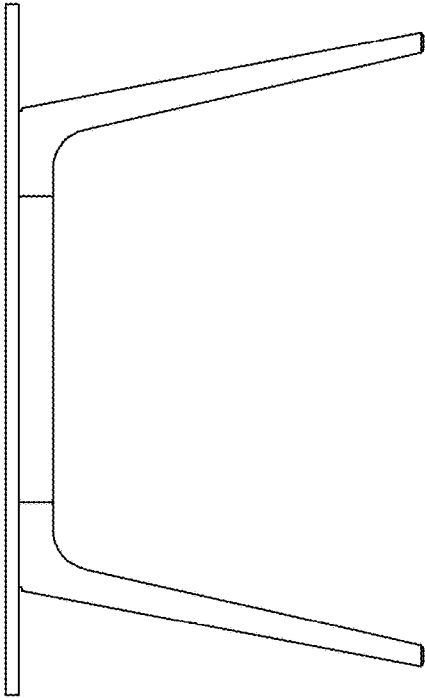

FIG. 21

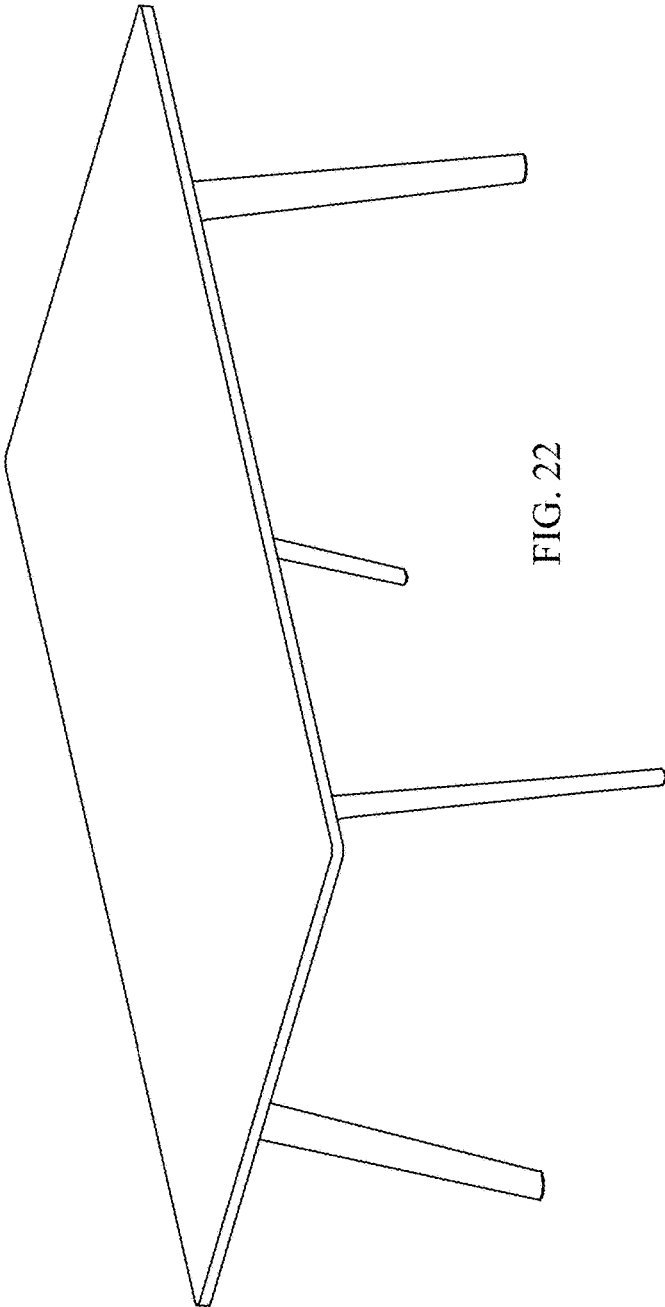

FIG. 22



FIG. 23

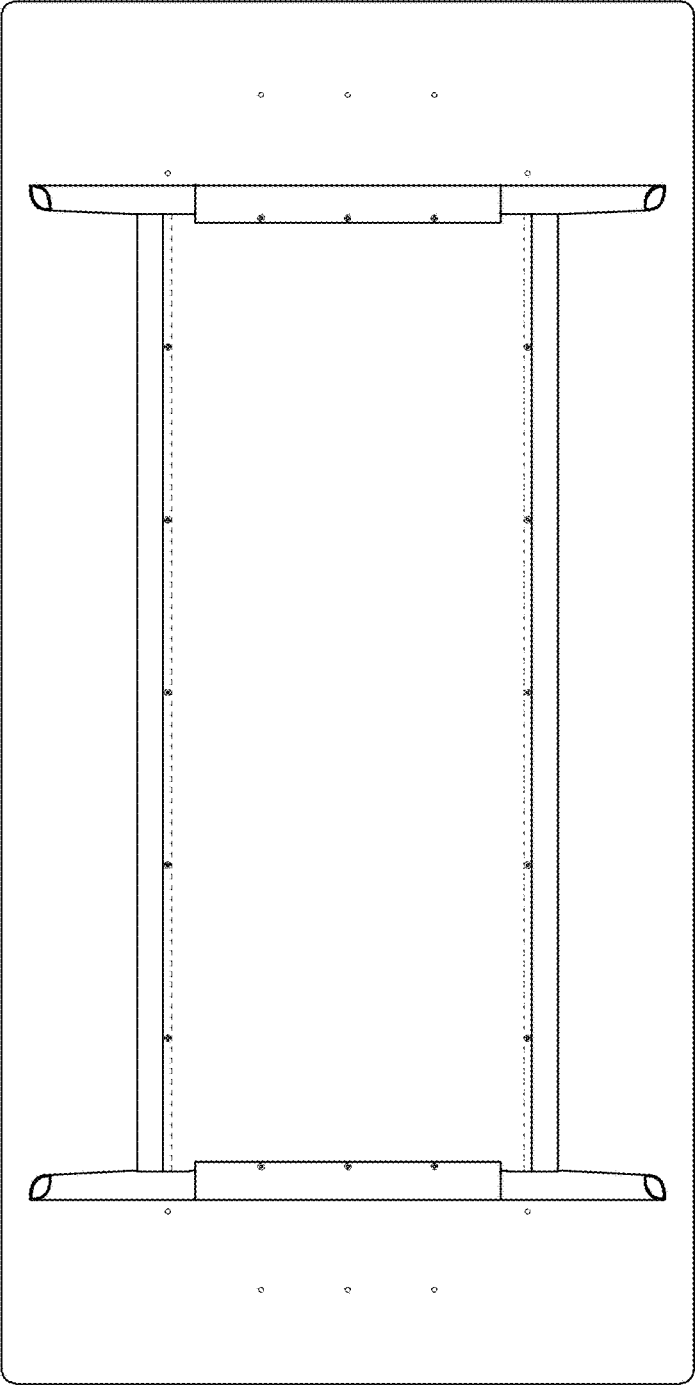

FIG. 24

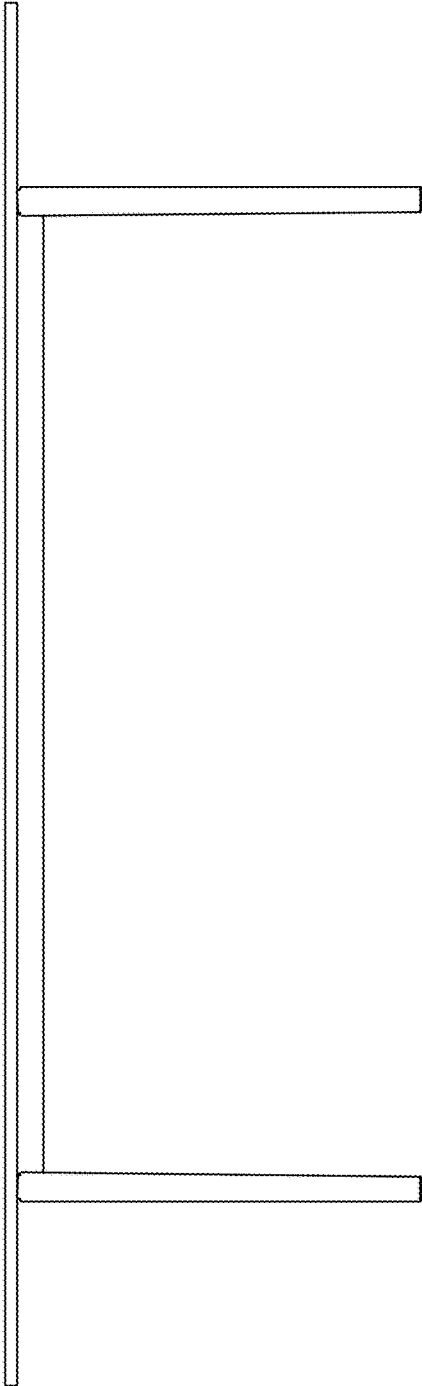

FIG. 25

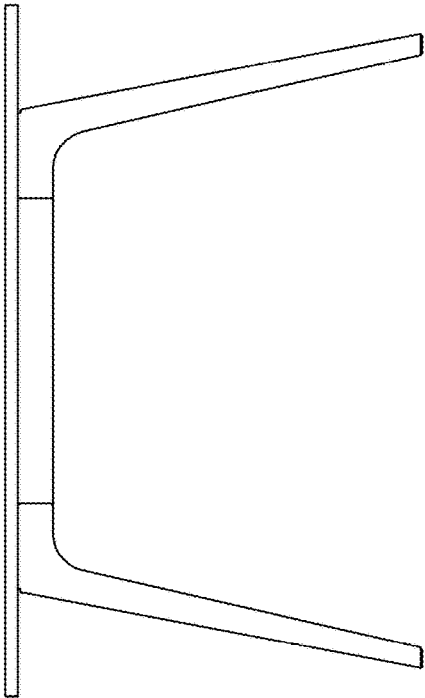

FIG. 26

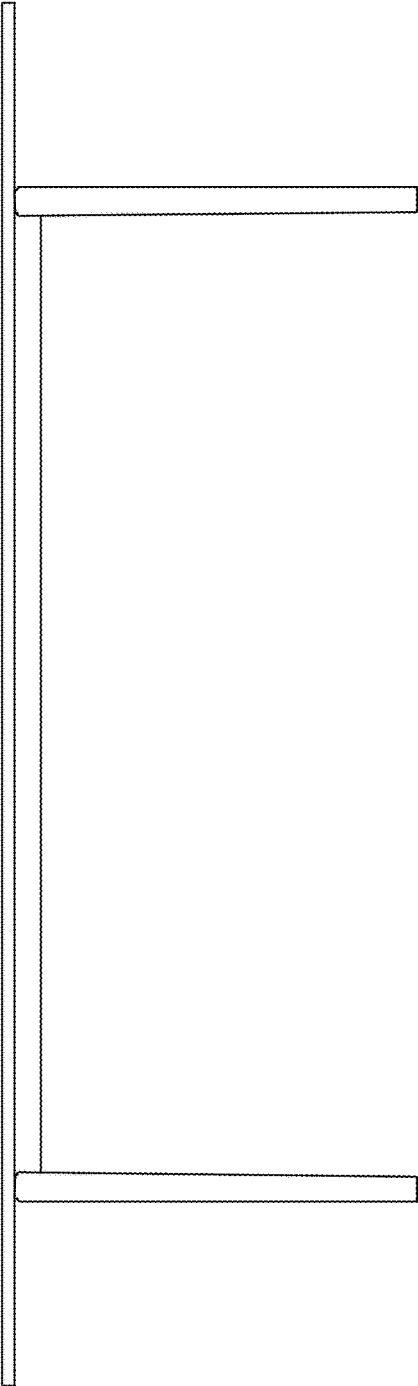

FIG. 27

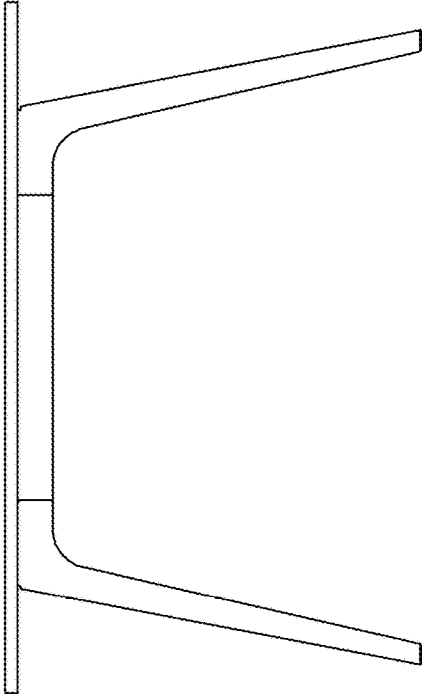

FIG. 28