



US00D349944S

# United States Patent [19] Harris

[11] Patent Number: **Des. 349,944**

[45] Date of Patent: **\*\* Aug. 23, 1994**

- [54] CONTAINER FOR BULK MATERIALS
- [75] Inventor: **Jack E. Harris**, Savannah, Ga.
- [73] Assignee: **Encon, Inc.**, Romeo, Mich.
- [\*\*] Term: **14 Years**
- [21] Appl. No.: **8,210**
- [22] Filed: **May 12, 1993**
- [52] U.S. Cl. .... **D23/202**
- [58] Field of Search ..... D9/414, 431; 206/503, 206/505, 509, 511, 508, 515; 220/1.5, 4.12, 4.16, 561, 562, 565; 222/105, 143, 185; D23/202-206; D34/38

[56] **References Cited**

**U.S. PATENT DOCUMENTS**

D. 216,590	2/1970	Coleman	.....	D23/202
D. 319,904	9/1991	Cozzi et al.	.....	D9/414 X
D. 332,130	12/1992	Przytulla	.	
D. 337,367	7/1993	McKenzie et al.	.....	D23/202
2,887,251	5/1959	Mackridge	.	
3,729,121	4/1973	Cannon	.....	222/185
3,782,602	1/1974	Page	.....	222/143
4,157,609	6/1979	Schütz	.	
4,173,288	11/1979	Schutz	.	
4,426,015	1/1984	Preston et al.	.	
4,516,692	5/1985	Croley	.	
4,690,299	9/1987	Cannon	.	
4,746,034	5/1988	Ata et al.	.....	222/185 X
4,793,519	12/1988	Voorhies, Jr.	.	
4,930,661	6/1990	Voorhies	.	
4,995,588	2/1991	Nichols	.	
5,024,346	6/1991	Roser	.....	222/105 X
5,029,734	7/1991	Nichols	.	
5,064,096	11/1991	Illing et al.	.	
5,110,000	5/1992	Nichols	.	
5,111,937	5/1992	Schutz	.	
5,133,476	7/1992	Schutz	.	
5,156,268	10/1992	Nichols	.	

**FOREIGN PATENT DOCUMENTS**

9221575 12/1992 PCT Int'l Appl. .

**OTHER PUBLICATIONS**

"Introducing Tuff Tank.", Chemical Handling Equip-

ment Co., Inc., 5451 Enterprise Blvd., Toledo, Ohio 43612; 2 pages; 1987.  
 "Atlas 360" and Saturn 350; Georgia Polymer Inc., P.O. Box 161554, Atlanta, Ga. 30321; 4 pages; date unknown. 1 page from "Hazmat World"; 1991.  
 1 page; Consolidated Plastics, Twinsburg, Ohio 44087; date unknown.  
 Enpac Corporation, 8400 Baymeadows Way, Bldg. 18, Jacksonville, Fla. 32256; 1 page; 1991.  
 "The Uni-Pak Bulk system", Shuert Industries Sales Inc., 6600 Dobry Road, Sterling Heights, Mich. 48314; 6 pages; date unknown.  
 21st Century Containers, Ltd., 150 Selig Drive, Atlanta, Ga. 30336; 5 pages; 1992.  
 "Concertainer", Van Leer Nederland B.V., Fibre Drums & Plastic Containers, Keulsekade 216, 3534 AC Utrecht; 4 pages; date unknown.  
 "The Sonobulk System"; Sonoco IBC, 100 Alex Street, Lavonia, Ga. 30553; 8 pages; date unknown.  
 Bonar Plastics Inc., 1005 Atlantic Drive, West Chicago, Ill. 60185; 39 pages; date unknown.  
 "Duratank", Hoover Group Incorporated, Alpharetta, Ga. 30201; 26 pages; 1991.

*Primary Examiner*—Prabhakar G. Deshmukh  
*Attorney, Agent, or Firm*—Renner, Kenner, Greive, Bobak, Taylor & Weber

[57] **CLAIM**

The ornamental design for a container for bulk materials, as shown and described.

**DESCRIPTION**

FIG. 1 is a perspective view of a container for bulk materials embodying my new design;  
 FIG. 2 is a front elevational view thereof;  
 FIG. 3 is a side elevational view thereof showing the side opposite to that shown in FIG. 1, the sides being identical in elevation;  
 FIG. 4 is a rear elevational view thereof;  
 FIG. 5 is a top plan view thereof; and,  
 FIG. 6 is a bottom plan view thereof.

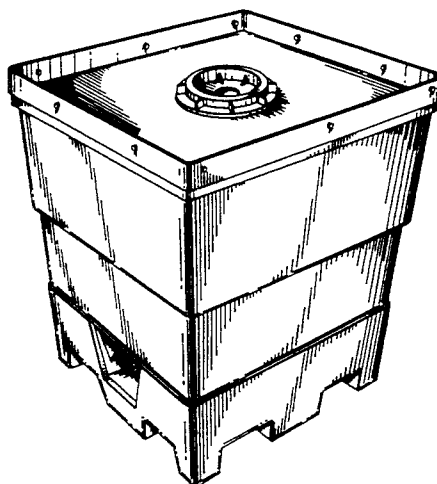

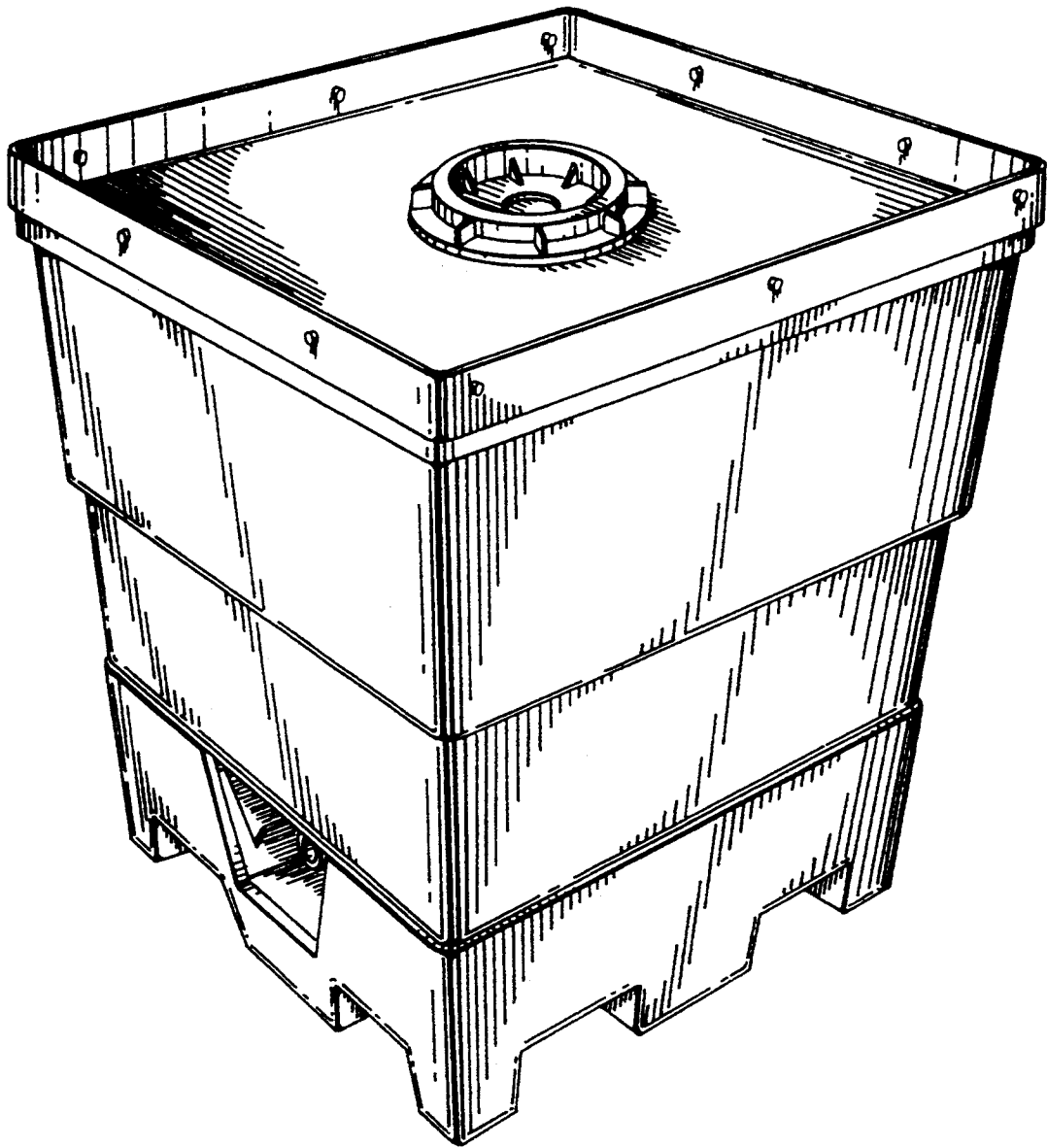

*FIG. 1*

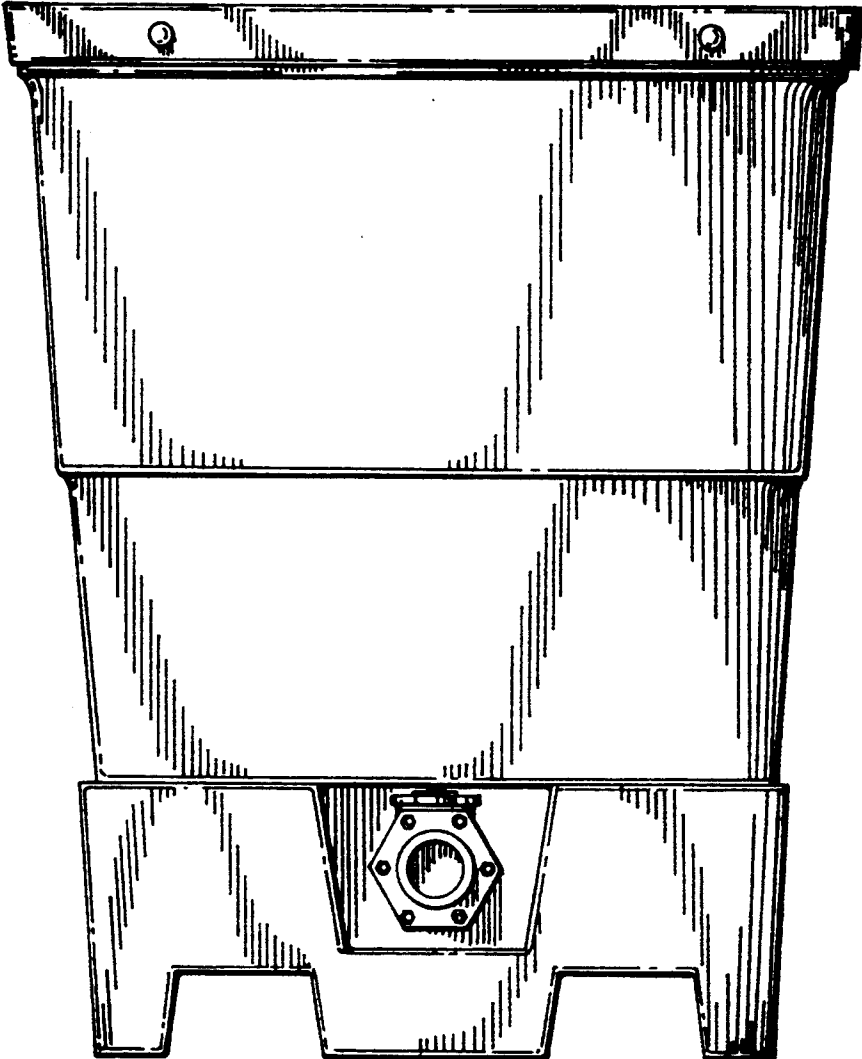
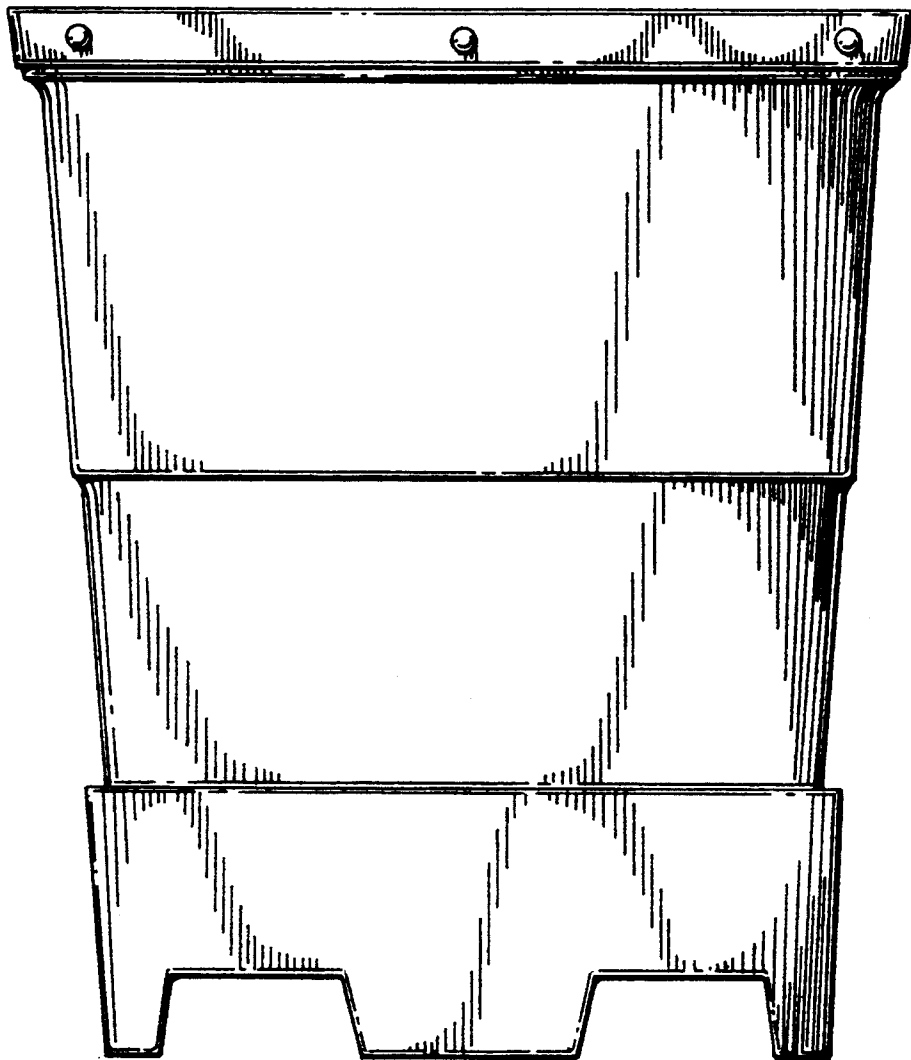
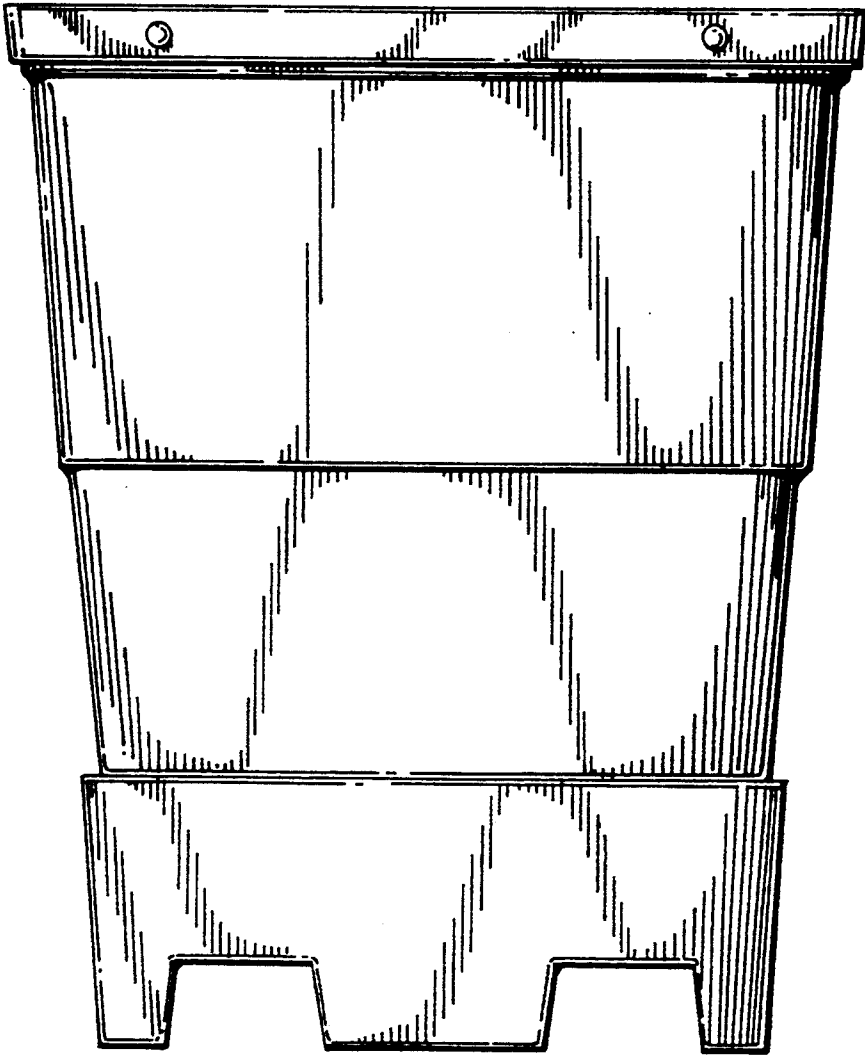

FIG. 2



*FIG. 3*



*FIG. 4*

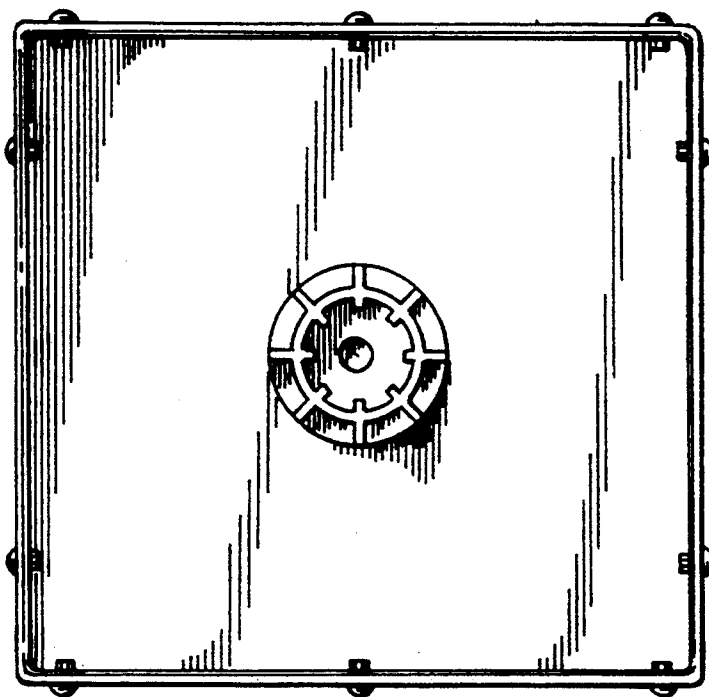

FIG. 5

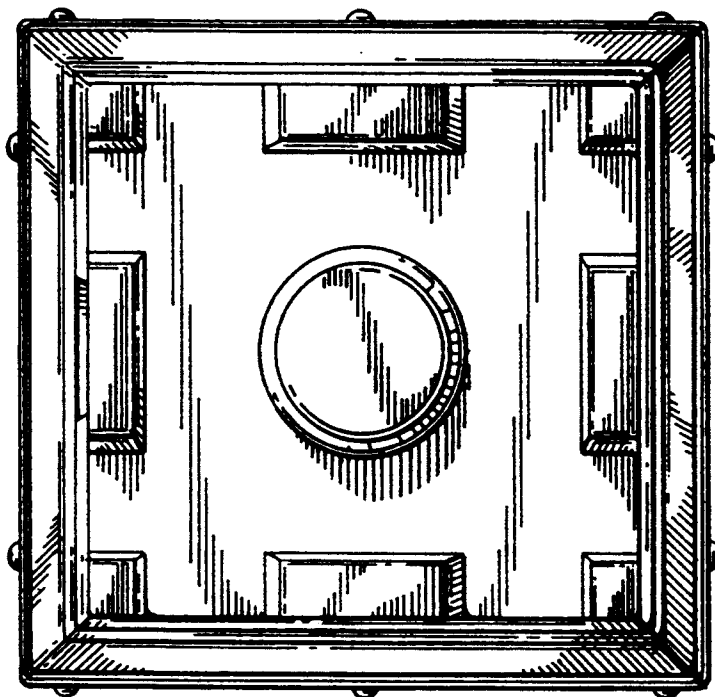

FIG. 6