



US00D975883S

(12) **United States Design Patent**
Welch

(10) **Patent No.:** **US D975,883 S**

(45) **Date of Patent:** **** Jan. 17, 2023**

(54) **PICKET CAP**

D928,987 S * 8/2021 Stegeman D25/126
D954,149 S * 6/2022 Hochman D25/138
D955,003 S * 6/2022 Palazzo D25/126

(71) Applicant: **Hunter Welch**, North Salt Lake, UT
(US)

(72) Inventor: **Hunter Welch**, North Salt Lake, UT
(US)

(**) Term: **15 Years**

(21) Appl. No.: **29/759,065**

(22) Filed: **Nov. 19, 2020**

(51) **LOC (14) Cl.** **25-01**

(52) **U.S. Cl.**
USPC **D25/135**

(58) **Field of Classification Search**
USPC D25/125, 126, 127, 128, 129, 130, 131,
D25/132, 133, 134, 135, 136, 60, 61, 119,
D25/121, 124, 138, 164; D8/363, 364,
D8/381

CPC E04C 2003/0482; E04C 2003/0434; E04H
17/1413; E04H 17/063; E04H 14/16;
E04H 17/20; E04B 2/7881

See application file for complete search history.

(56) **References Cited**

U.S. PATENT DOCUMENTS

D451,212 S * 11/2001 Merrick D25/135
D454,404 S * 3/2002 Merrick D25/135
D458,390 S * 6/2002 Ohanesian D25/135
D547,464 S * 7/2007 Petta D25/135
D567,392 S * 4/2008 Fears D25/42
D619,738 S * 7/2010 Mannhart D25/126
D726,343 S * 4/2015 Knudsen D25/135
D775,742 S * 1/2017 Kobelt D25/135
D807,533 S * 1/2018 Ray D25/135

OTHER PUBLICATIONS

Gothic Vinyl Picket Fence Caps https://www.amazon.com/Gothic-Vinyl-Picket-Fence-White/dp/B08KTMQLTS/ref=asc_df_B08KTMQLTS/?tag=hyprod-20&linkCode=df0&hvadid=475788616966&hvpos=&hvnetw=g&hvrand=12029634682343268211&hvpone=&hvpwo=&hvqmt=&hvdev=c&hvdvcmld=&hvlocint=&hvlocphy=1027019&hvtargid=pla-1027957547208&psc=1 Oct. 7, 2020 (Year: 2020).*

* cited by examiner

Primary Examiner — Samantha Q Lawrence
(74) *Attorney, Agent, or Firm* — Kirton McConkie; Brian Tucker

(57) **CLAIM**

The ornamental design for a picket cap, as shown and described.

DESCRIPTION

FIG. 1 is a top left isometric view of a picket cap showing the claimed design;
FIG. 2 is another top left isometric view thereof;
FIG. 3 is a bottom right isometric view thereof;
FIG. 4 is a front elevation view thereof with the rear elevation view being identical thereto;
FIG. 5 is a right-side elevation view thereof with the left-side elevation view being identical thereto;
FIG. 6 is a top plan view thereof; and,
FIG. 7 is a bottom plan view thereof.
The broken lines in FIG. 1 represent a fence and form no part of the claimed design.

1 Claim, 3 Drawing Sheets

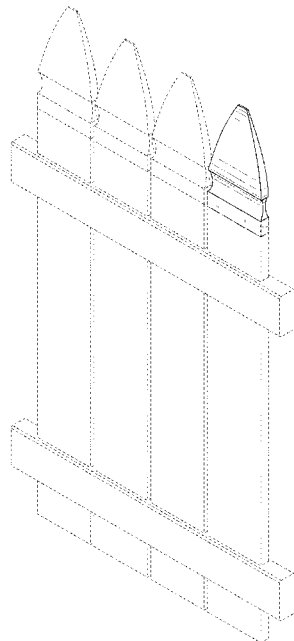

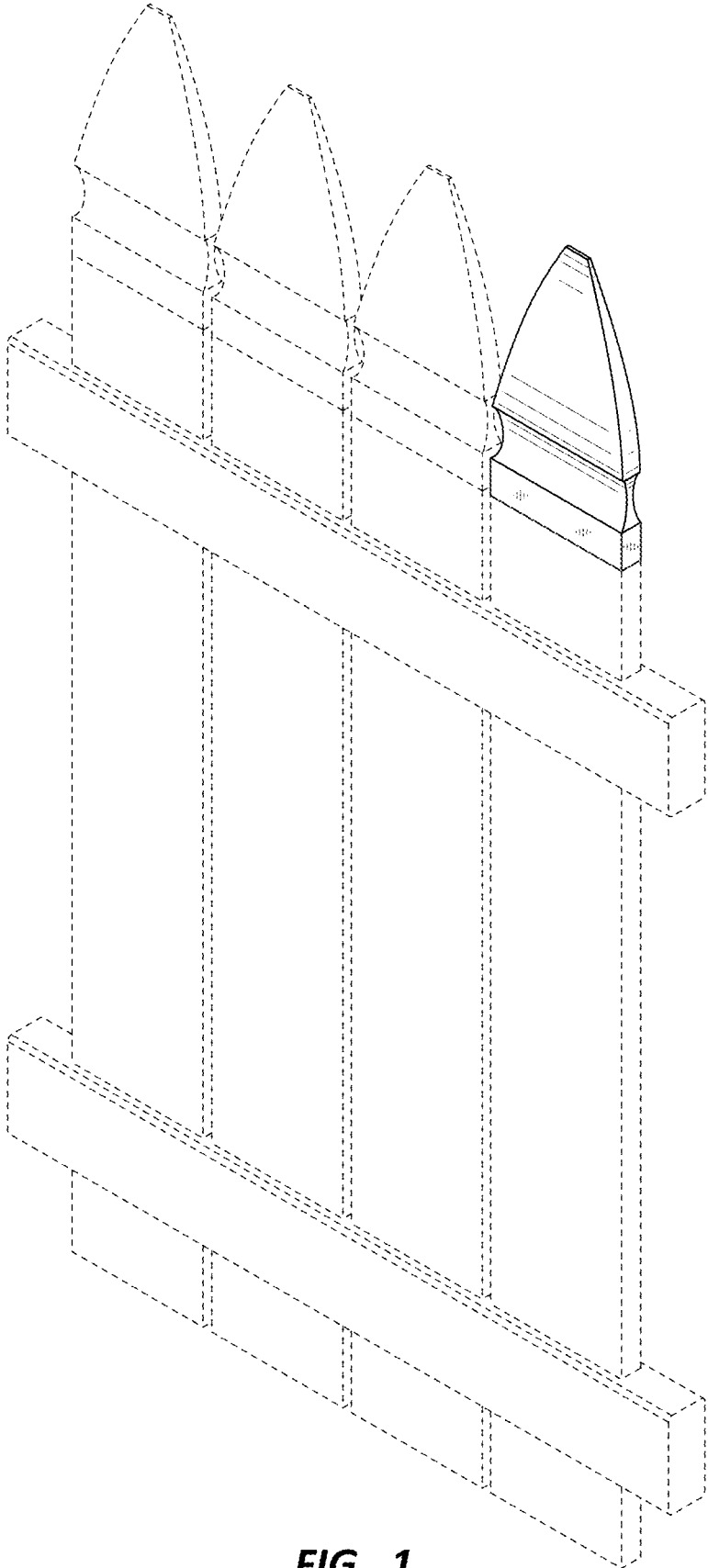

FIG. 1

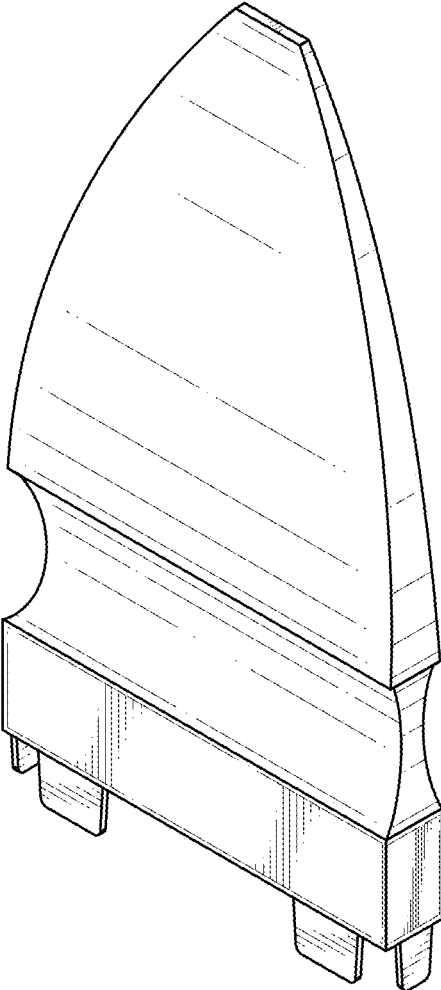

FIG. 2

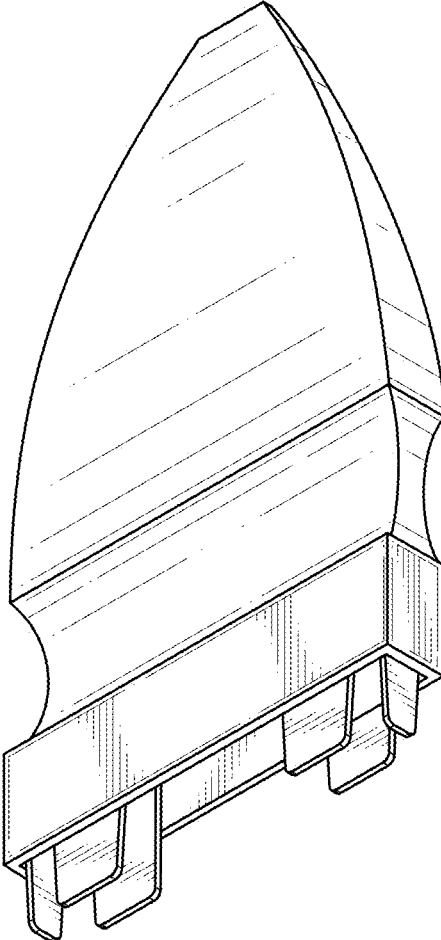

FIG. 3

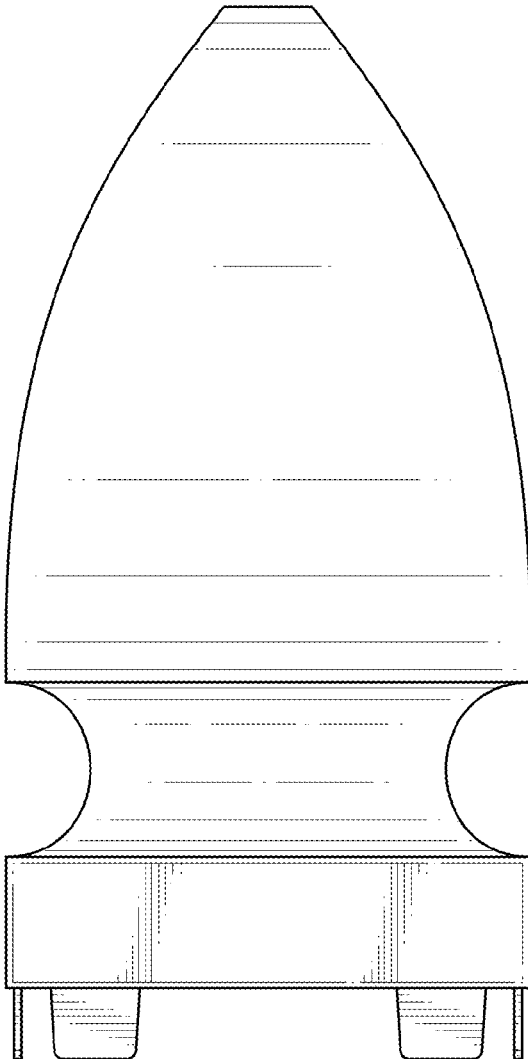

FIG. 4



FIG. 5

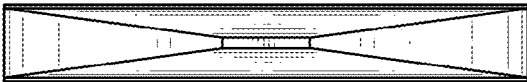

FIG. 6

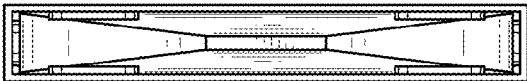

FIG. 7