



US00D345060S

United States Patent [19]

[11] Patent Number: Des. 345,060

Duncan

[45] Date of Patent: ** Mar. 15, 1994

[54] CHAIR

[75] Inventor: Terence M. Duncan, Kentwood, Mich.

[73] Assignee: JSJ Seating Corporation, Belton, Tex.

[**] Term: 14 Years

[21] Appl. No.: 822,557

[22] Filed: Jan. 16, 1992

[52] U.S. Cl. D6/366

[58] Field of Search D6/334, 365, 366, 374, D6/375, 379, 498, 500, 501, 502; 297/411

[56] References Cited

U.S. PATENT DOCUMENTS

D. 127,977	7/1941	Shepherd	D6/366
D. 184,187	12/1958	McCarthy et al.	D6/366
D. 211,461	6/1968	Walkinshaw	D6/366
D. 228,536	10/1973	Sottsass	D6/366
D. 270,497	9/1983	Ochsner	D6/366
D. 278,391	4/1985	Platner	D6/366
D. 291,160	8/1987	Biscoe	D6/366
D. 297,600	9/1988	Wilson	D6/366 X
D. 306,531	3/1990	Snodgrass	D6/366

OTHER PUBLICATIONS

Design Catalog, Jan. 1982, p. 39, Chair by All-Steel shown at left.

Jacobs Gardner, 1988, p. 34, Chair shown at top left.

Primary Examiner—Alan P. Douglas
Assistant Examiner—Gary D. Watson
Attorney, Agent, or Firm—Warner, Norcross & Judd

[57] CLAIM

The ornamental design for a chair, as shown and described.

DESCRIPTION

FIG. 1 is a perspective view showing the chair design of the present invention;

FIG. 2 is a front elevational view thereof;

FIG. 3 is a rear elevational view thereof;

FIG. 4 is a side elevational view thereof, the opposite side being the mirror image thereof;

FIG. 5 is a top plan view thereof;

FIG. 6 is a perspective view of a first alternative embodiment of the chair design of the present invention;

FIG. 7 is a front elevational view thereof;

FIG. 8 is a rear elevational view thereof;

FIG. 9 is a side elevational view thereof, the opposite side being the mirror image thereof;

FIG. 10 is a top plan view thereof;

FIG. 11 is a perspective view of a second alternative embodiment of the chair design of the present invention;

FIG. 12 is a front elevational view thereof;

FIG. 13 is a rear elevational view thereof;

FIG. 14 is a side elevational view thereof, the opposite side being the mirror image thereof; and,

FIG. 15 is a top plan view thereof.

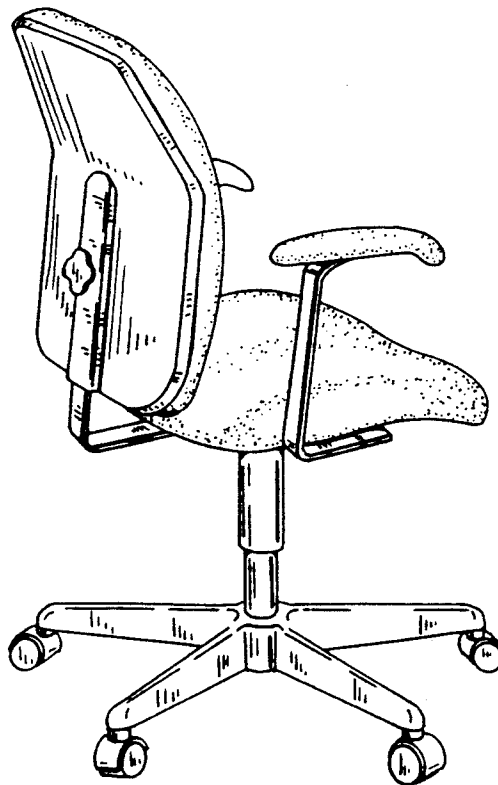

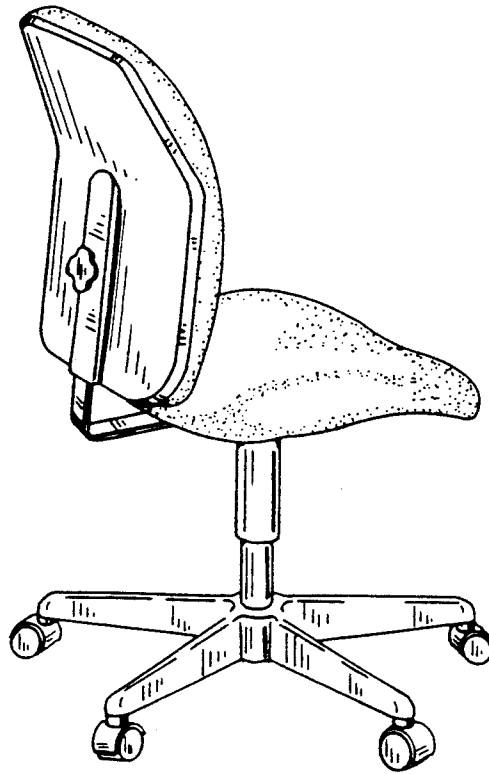

FIG. 1

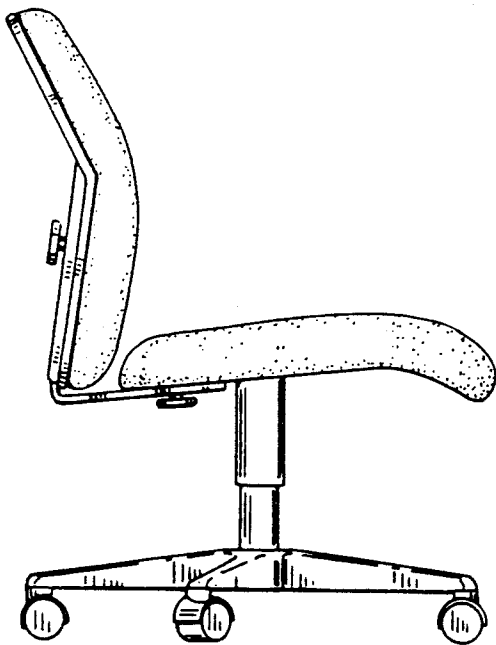

FIG. 4

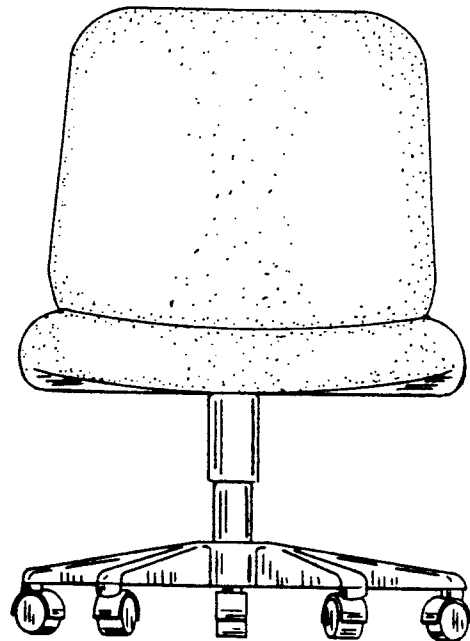

FIG. 2

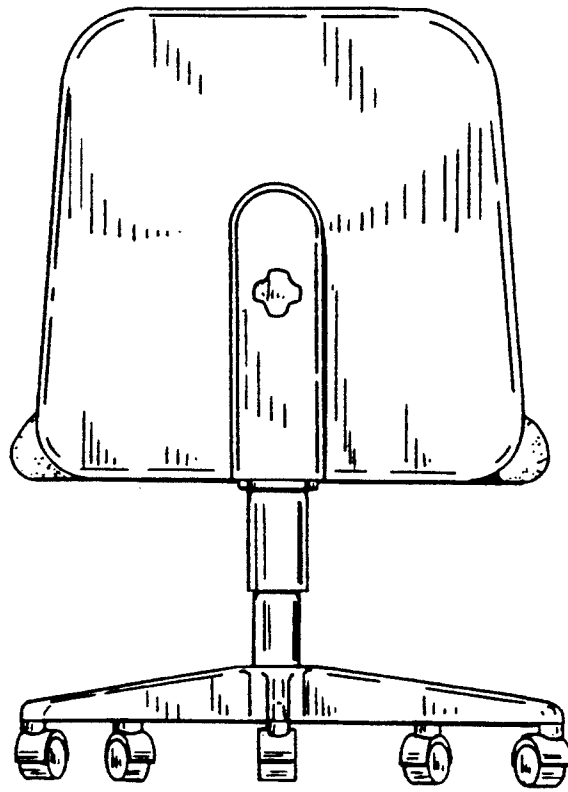

FIG. 3

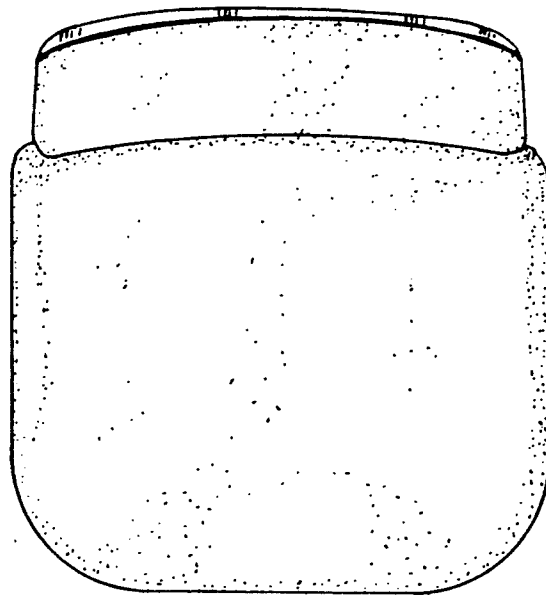

FIG. 5

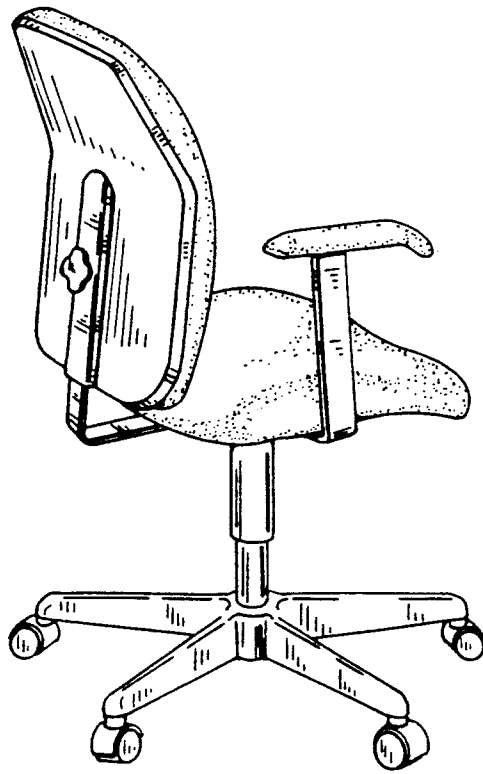

FIG. 6

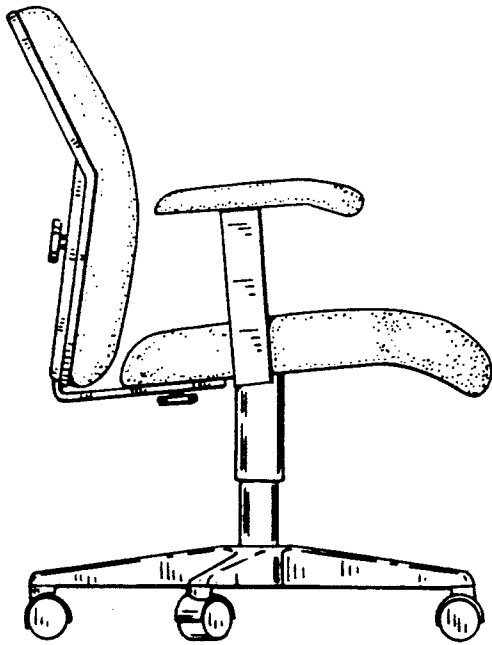

FIG. 9

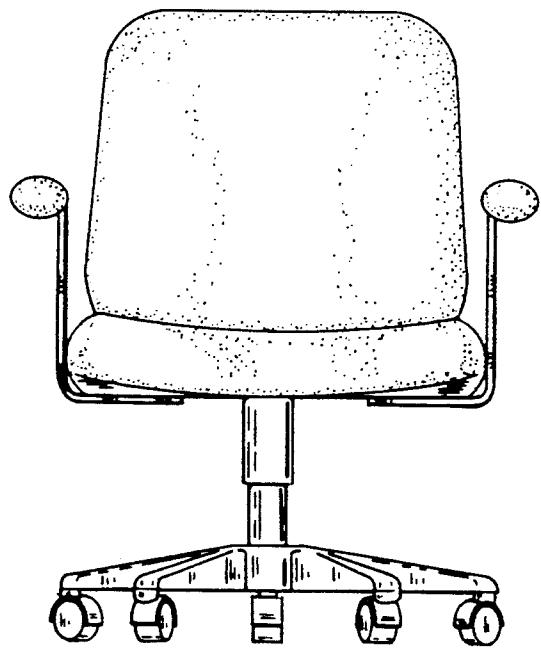

FIG. 7

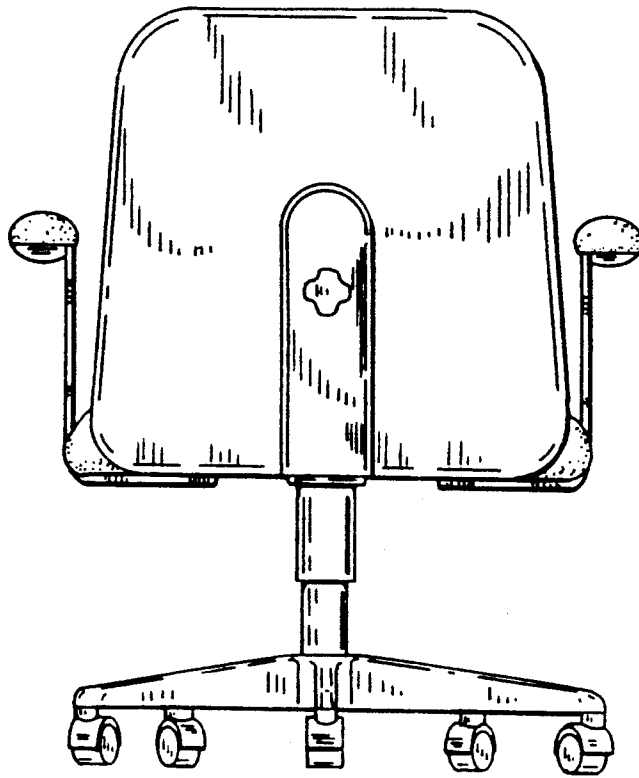

FIG. 8

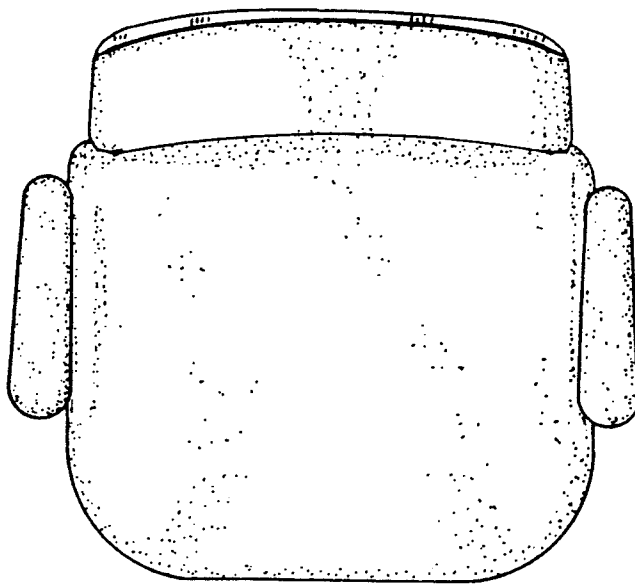

FIG. 10

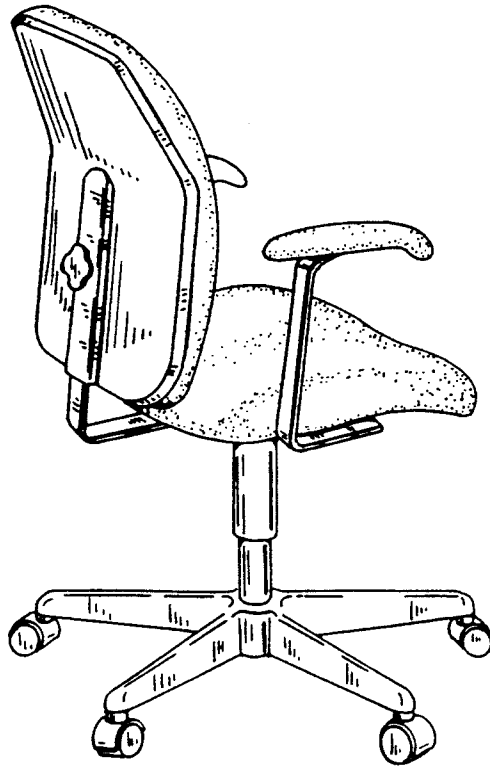

FIG. 11

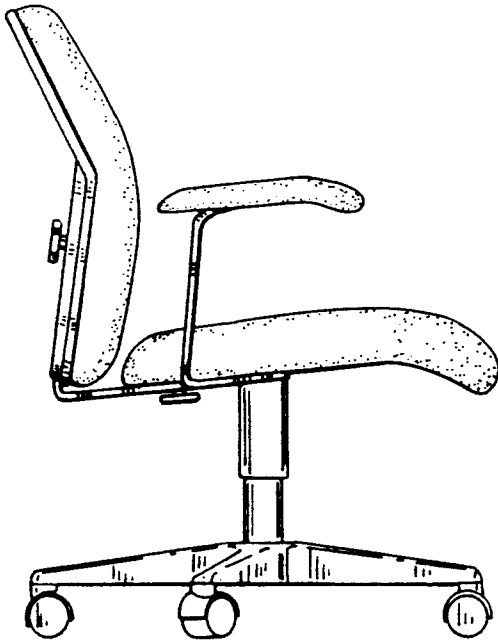

FIG. 14

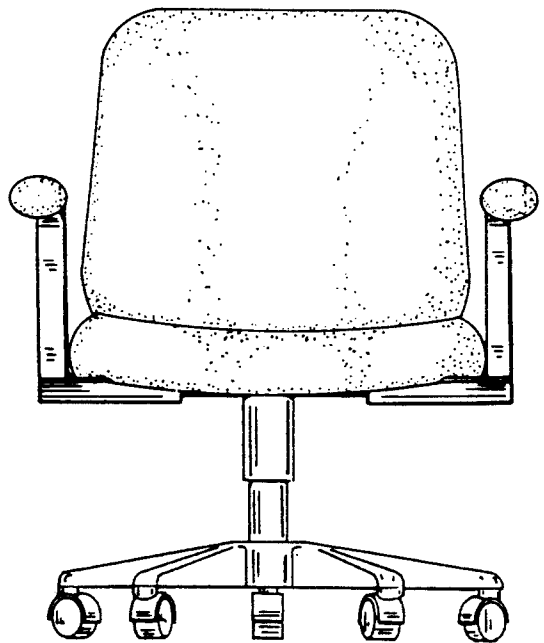

FIG. 12

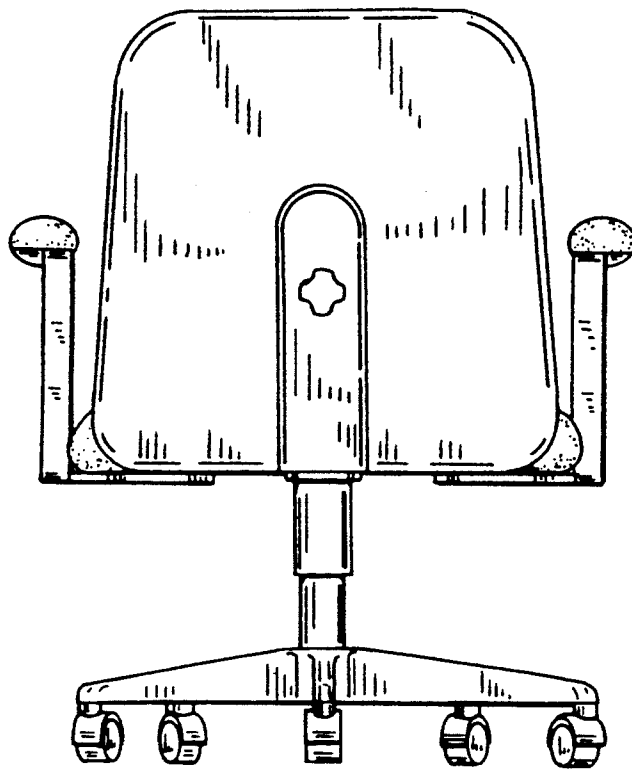

FIG. 13

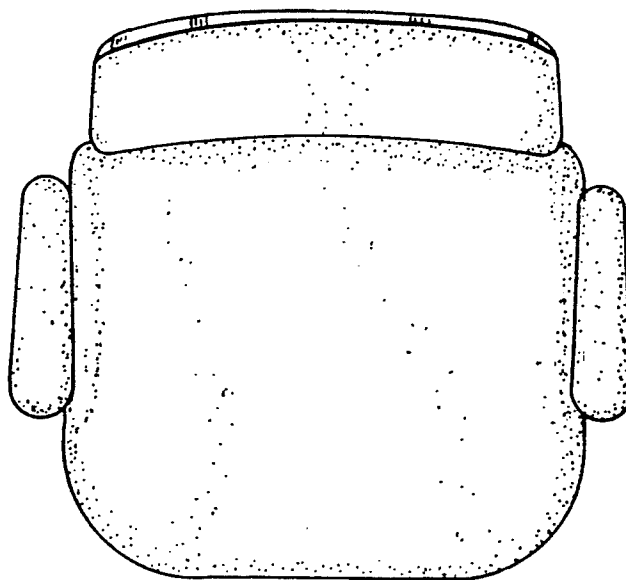

FIG. 15