



US00D666491S

(12) **United States Design Patent**
Adams et al.

(10) **Patent No.:** **US D666,491 S**

(45) **Date of Patent:** **** Sep. 4, 2012**

(54) **OVERCAP**

(75) Inventors: **Mary Beth Adams**, Antioch, IL (US);
Daniel A. Andersen, Burlington, WI
(US); **Jeffrey J. Christianson**, Oak
Creek, WI (US); **Matthew Grossman**,
Austin, TX (US); **Kit R. Morris**, Austin,
TX (US); **Han Xin**, Austin, TX (US)

D434,658 S 12/2000 Geier
D436,038 S 1/2001 Ruiz de Gopegui
D447,948 S 9/2001 Pannozzo et al.
6,302,302 B1 10/2001 Albisetti
D457,429 S * 5/2002 Walters D9/448
6,398,082 B2 6/2002 Clark et al.
D462,009 S 8/2002 Poisson et al.
(Continued)

(73) Assignee: **S.C. Johnson & Son, Inc.**, Racine, WI
(US)

FOREIGN PATENT DOCUMENTS
AU 337186 S 6/2011
(Continued)

(**) Term: **14 Years**

OTHER PUBLICATIONS

(21) Appl. No.: **29/397,465**

Precision Valve Corporation product page of spray caps from
precisionglobal.com website [online] [retrieved on Feb. 2, 2012], 2
pages. Retrieved from <URL: [http://www.precisionglobal.com/en/
products/catalog/group/domes](http://www.precisionglobal.com/en/products/catalog/group/domes)>.

(22) Filed: **Jul. 15, 2011**

(Continued)

(51) **LOC (9) Cl.** **09-07**

(52) **U.S. Cl.** **D9/448; D9/445**

(58) **Field of Classification Search** D9/688,
D9/686, 682, 454, 448, 445, 44; D6/544,
D6/542; D28/76; D23/255, 252, 238; 222/630,
222/631, 566, 402.22, 402.13, 402.1, 401,
222/330, 331, 252, 153.07, 135
See application file for complete search history.

Primary Examiner — Susan Bennett Hattan

(57) **CLAIM**

The ornamental design for an overcap, as shown and
described.

DESCRIPTION

(56) **References Cited**

U.S. PATENT DOCUMENTS

D225,731 S * 1/1973 Louise D9/448
D236,084 S 7/1975 Petterson
D313,345 S 1/1991 Wefler et al.
D388,319 S 12/1997 Lamb et al.
D395,597 S 6/1998 Lamb
D406,763 S 3/1999 Watkins et al.
D413,514 S * 9/1999 Pericard et al. D9/448
D413,793 S 9/1999 Favre
D414,416 S 9/1999 Watkins
6,000,633 A 12/1999 Lund et al.

FIG. 1 is an isometric view of a top, front, and left side of an
ornamental design for an overcap;

FIG. 2 is a front elevational view of the overcap of FIG. 1;
FIG. 3 is a rear elevational view of the overcap of FIG. 1;
FIG. 4 is a left side elevational view of the overcap of FIG. 1;
FIG. 5 is a right side elevational view of the overcap of FIG.
1; and,

FIG. 6 is a top plan view of the overcap of FIG. 1.
The bottom view forms no part of the claimed design.

1 Claim, 3 Drawing Sheets

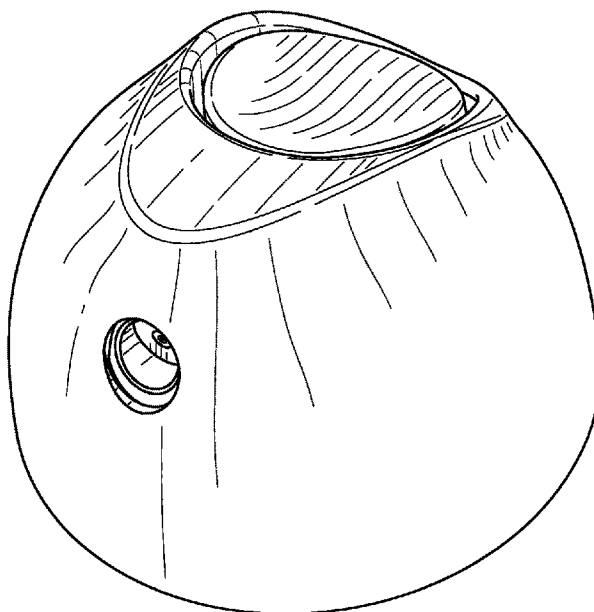

U.S. PATENT DOCUMENTS

D462,896 S	9/2002	Crawford et al.	
D471,106 S	3/2003	Pannozzo et al.	
D478,284 S	8/2003	Pannozzo et al.	
D478,285 S	8/2003	Pannozzo et al.	
D482,972 S	12/2003	Young et al.	
D490,699 S	6/2004	Nelson et al.	
D491,064 S	6/2004	Miller et al.	
D492,193 S	6/2004	Miller et al.	
D497,808 S	11/2004	Morris et al.	
D507,487 S	7/2005	Marroncles	
D508,209 S	8/2005	Lamb et al.	
D508,851 S	8/2005	Nelson et al.	
D511,302 S	11/2005	Lamb et al.	
D512,313 S	12/2005	Liu	
D513,995 S	1/2006	Miwa	
7,036,691 B2	5/2006	Nicolas	
D527,630 S	9/2006	McConville et al.	
7,104,427 B2	9/2006	Pericard et al.	
D532,300 S	11/2006	Moretti	
D532,301 S	11/2006	Moretti	
D532,302 S	11/2006	Moretti	
D533,074 S	12/2006	Mongeon et al.	
D536,969 S	2/2007	Geier	
D537,715 S	3/2007	Downey et al.	
D543,106 S	5/2007	Foster et al.	
D557,145 S	12/2007	Miller et al.	
D561,024 S	2/2008	Altonen et al.	
D565,947 S *	4/2008	Downey et al.	D9/448
D567,651 S	4/2008	Bloc	
D569,247 S	5/2008	Decottignies	
D575,153 S	8/2008	Caroen et al.	
D576,490 S	9/2008	Mazurkiewicz et al.	
D578,005 S	10/2008	Shurtleff et al.	
D579,342 S	10/2008	Claughton et al.	
D580,265 S	11/2008	Turchi	
D580,776 S	11/2008	Claughton et al.	
D587,576 S	3/2009	Miller et al.	
D596,939 S	7/2009	Moretti	
D602,363 S	10/2009	Chaffier	
D625,998 S	10/2010	Claassen	
7,854,356 B2	12/2010	Eberhardt	

7,922,041 B2	4/2011	Gurrisi et al.	
D643,303 S	8/2011	Bicknell et al.	
D653,559 S	2/2012	Bicknell et al.	
D662,415 S	6/2012	Bicknell et al.	
2003/0129142 A1	7/2003	Schroeder et al.	
2004/0140328 A1*	7/2004	Pericard et al.	222/402.13

FOREIGN PATENT DOCUMENTS

AU	337187 S	6/2011
DE	49810455-0001	7/1999
EM	000155338-0002	6/2004
EM	000318928-0001	5/2005
EM	000391719-0009	10/2005
EM	000415260-0001	2/2006
EM	000449855-0002	2/2006
EM	000500152-0001	6/2006
EM	000512207-0001	6/2006
EM	000729306-0003	6/2007
EM	000735139-0002	6/2007
EM	007491480007	7/2007
EM	001733338-0001	7/2010
GB	2038953	11/1993
GB	2055558	4/1996
GB	2072025	1/1998
GB	2082538	10/1998
GB	3020280	3/2005
WO	DM048855	10/1999
WO	DM057973	12/2001
WO	DM064600	12/2003
WO	2010052168 A1	5/2010

OTHER PUBLICATIONS

Dove Original Anti Perspirant Spray Deodorant, <<http://www.amazon.com/Dove-Original-Perspirant-Spray-Deodorant-150/dp/B001RYNL3G>>, accessed on Jun. 27, 2012.
 Imperial Leather Foamburst Foaming Shower Gel, <<http://www.pakswholesale.com/brand/cussons/cussons/imperial-leather-foamburst-foaming-shower-gel.html>>, accessed on Jun. 27, 2012.
 Mum Active Clear Antiperspirant, <<http://www.pharmacyathand.co.uk/gbu0-prodshow/Mum-Deodorant-Active-Clear-Anti-Perspirant-Spray.html>>, accessed on Jun. 27, 2012.

* cited by examiner

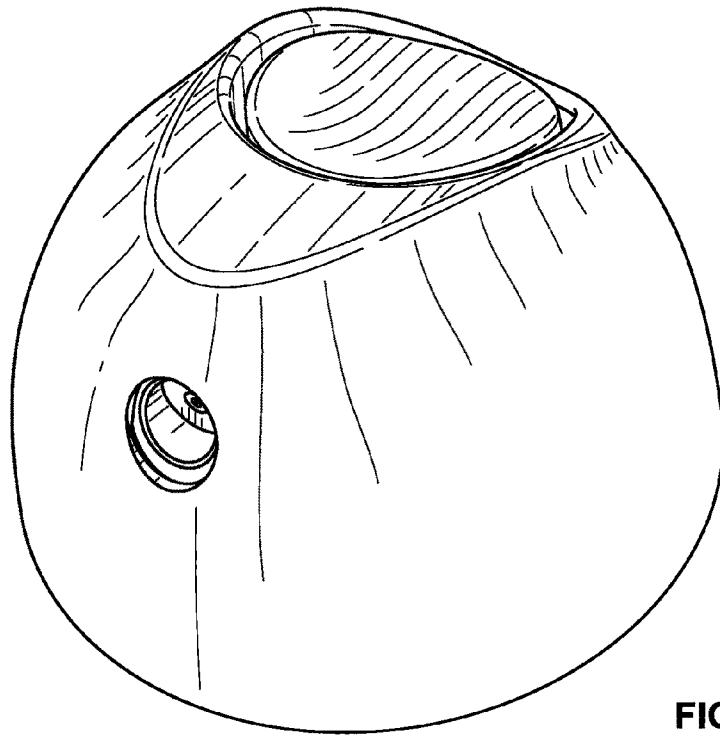

FIG. 1

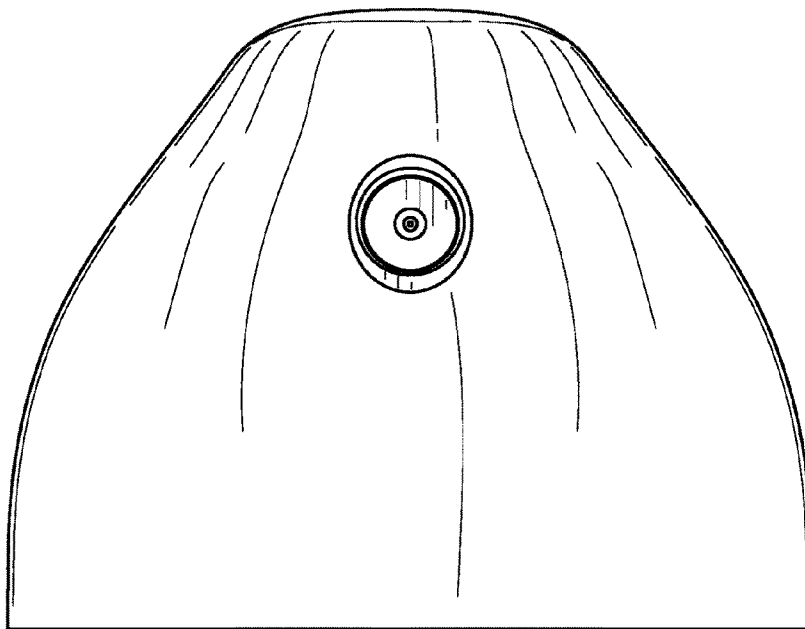

FIG. 2

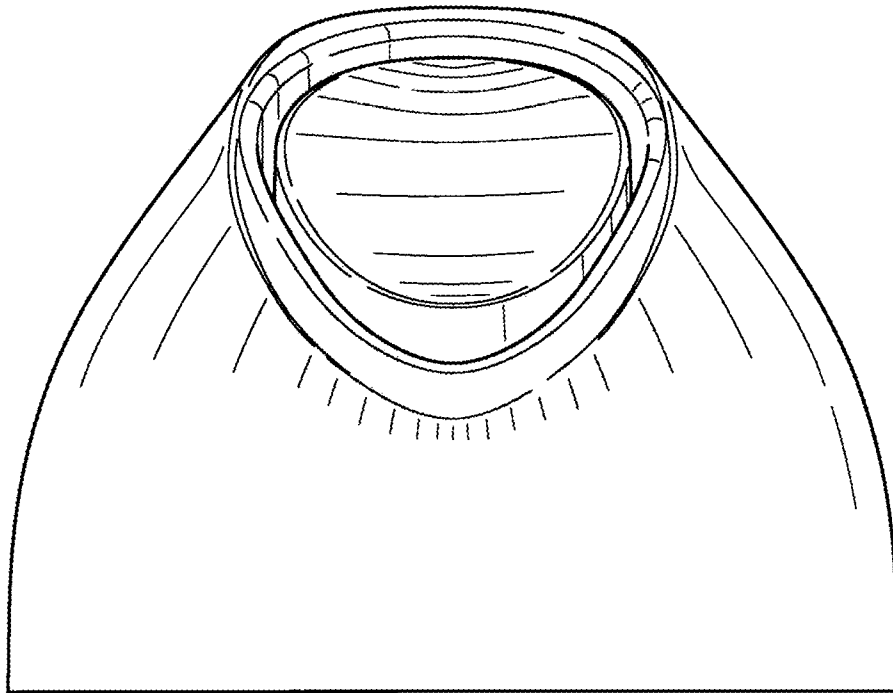

FIG. 3

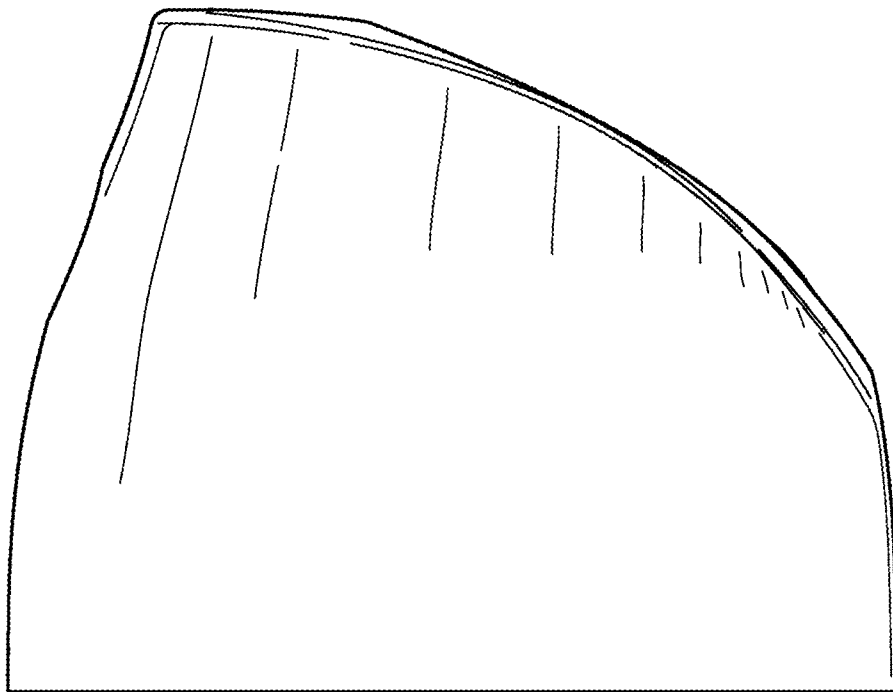

FIG. 4

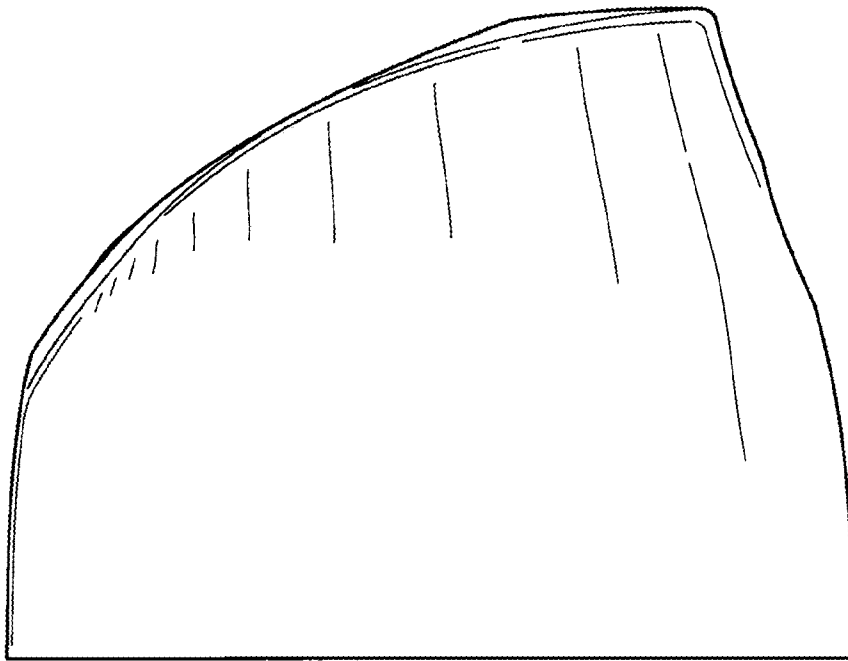

FIG. 5

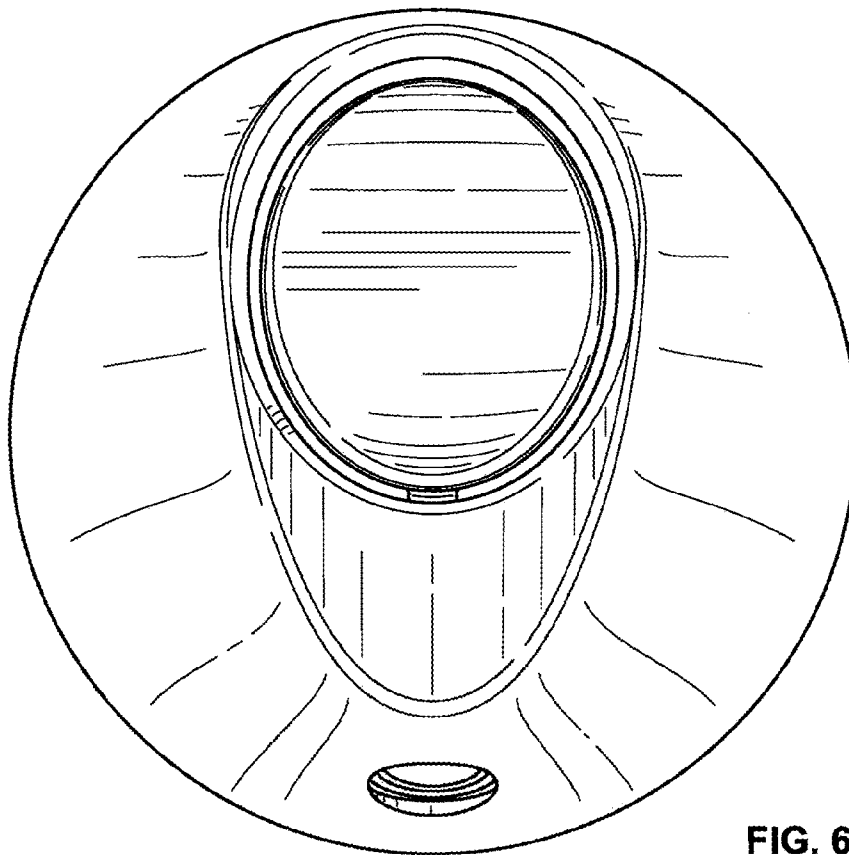

FIG. 6