



(12) **United States Design Patent**  
**Ding**

(10) **Patent No.:** **US D985,290 S**  
(45) **Date of Patent:** **\*\* May 9, 2023**

(54) **COMBINED ELECTRIC PEPPER MILL AND USB**

(74) *Attorney, Agent, or Firm* — ScienBiziP, P.C.

(71) Applicant: **Yiwu Siwei Technology Co., Ltd.**,  
Zhejiang (CN)

(57) **CLAIM**  
The ornamental design for an combined electric pepper mill and USB, as shown and described.

(72) Inventor: **Changjiang Ding**, Zhejiang (CN)

**DESCRIPTION**

(73) Assignee: **Yiwu Siwei Technology Co., Ltd.**,  
Zhejiang (CN)

(\*\*) Term: **15 Years**

(21) Appl. No.: **29/798,803**

(22) Filed: **Jul. 9, 2021**

(30) **Foreign Application Priority Data**

Jun. 11, 2021 (CN) ..... 202130365278.X

(51) **LOC (14) Cl.** ..... **31-00**

(52) **U.S. Cl.**  
USPC ..... **D7/372; D7/679**

(58) **Field of Classification Search**  
USPC ..... D7/368, 669, 679, 372, 373; D27/194,  
D27/195

(Continued)

(56) **References Cited**

**U.S. PATENT DOCUMENTS**

D96,679 S \* 8/1935 Kopf ..... D7/372  
2,022,151 A \* 11/1935 Riddle ..... A47J 43/25  
241/89.4

(Continued)

**OTHER PUBLICATIONS**

Amazon.com, ChewFun Store, Electric Gravity Pepper Grinder Salt Mill, ASIN: B09NVD1FGX, 10 pages, date first available Dec. 20, 2021 (Year: 2021).\*

(Continued)

*Primary Examiner* — Terry A Wallace

FIG. 1 is a front, right, and top perspective view of a first embodiment of an combined electric pepper mill and USB, showing my design.

FIG. 2 is a rear, left, and bottom perspective view the first embodiment of the combined electric pepper mill and USB of FIG. 1.

FIG. 3 is a front elevation view the first embodiment of the combined electric pepper mill and USB of FIG. 1.

FIG. 4 is a rear elevation view the first embodiment of the combined electric pepper mill and USB of FIG. 1.

FIG. 5 is a left side elevation view the first embodiment of the combined electric pepper mill and USB of FIG. 1.

FIG. 6 is a right side elevation view the first embodiment of the combined electric pepper mill and USB of FIG. 1.

FIG. 7 is a top plan view the first embodiment of the combined electric pepper mill and USB of FIG. 1.

FIG. 8 is a bottom plan view the first embodiment of the combined electric pepper mill and USB of FIG. 1.

FIG. 9 is a front, right, and top perspective view of a second embodiment of an combined electric pepper mill and USB, showing my design.

FIG. 10 is a rear, left, and bottom perspective view of the second embodiment of the combined electric pepper mill and USB of FIG. 9.

FIG. 11 is a front elevation view the second embodiment of the combined electric pepper mill and USB of FIG. 9.

FIG. 12 is a rear elevation view the second embodiment of the combined electric pepper mill and USB of FIG. 9.

FIG. 13 is a left side elevation view the second embodiment of the combined electric pepper mill and USB of FIG. 9.

FIG. 14 is a right side elevation view the second embodiment of the combined electric pepper mill and USB of FIG. 9.

FIG. 15 is a top plan view the second embodiment of the combined electric pepper mill and USB of FIG. 9; and,

(Continued)

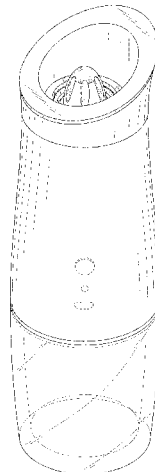

FIG. 16 is a bottom plan view the second embodiment of the combined electric pepper mill and USB of FIG. 9. The broken lines shown in the drawings are included for the purpose of illustrating portions of the combined electric pepper mill and USB that form no part of the claimed design.

**1 Claim, 16 Drawing Sheets**

(58) **Field of Classification Search**

CPC ..... B02C 18/24; B02C 18/08; B02C 18/16;  
 B02C 18/00; B02C 7/00; B02C 7/02;  
 B02C 7/04; A47J 42/00; A47J 42/40;  
 A47J 42/04; A47J 42/14; A47J 42/24;  
 A47J 42/34; A47J 42/30; A47J 42/36;  
 A47J 42/20; A47J 43/25; A47J 43/255;  
 A47J 43/04; A47J 43/06; A47J 43/40;  
 B26B 27/00; A24B 7/00; A24F 23/04

See application file for complete search history.

(56)

**References Cited**

U.S. PATENT DOCUMENTS

D284,252	S *	6/1986	Lichtenvort .....	D7/597
D318,779	S *	8/1991	Wong .....	D7/596
D320,326	S *	10/1991	Barrault .....	D7/381
D361,478	S *	8/1995	Kinsman .....	D7/679
D506,361	S *	6/2005	Lee .....	D7/679
D529,769	S *	10/2006	Tardif .....	D7/679
D710,660	S *	8/2014	Roberts, Jr. ....	D7/679
2018/0229243	A1 *	8/2018	Nocine .....	A47J 42/30

OTHER PUBLICATIONS

Amazon.com, LISRSC Store Pepper Grinder Gravity Electric Pepper Mill, ASIN: B07ZNN688Z, 10 pages, date first available Oct. 27, 2019 (Year: 2019).\*

\* cited by examiner

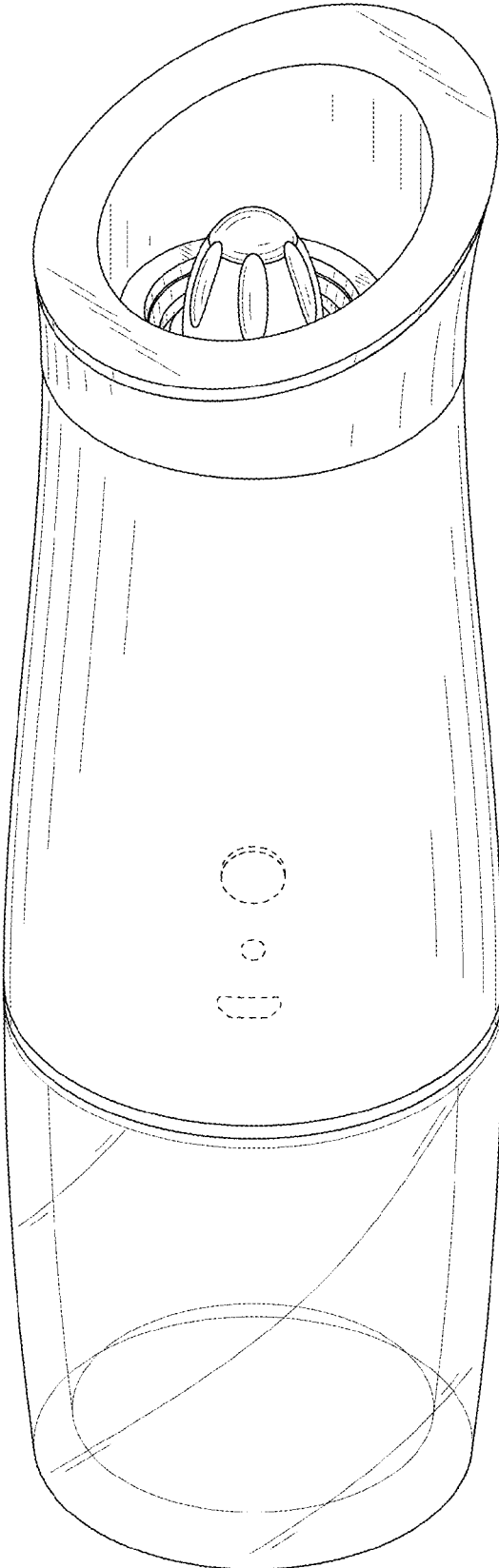

FIG. 1

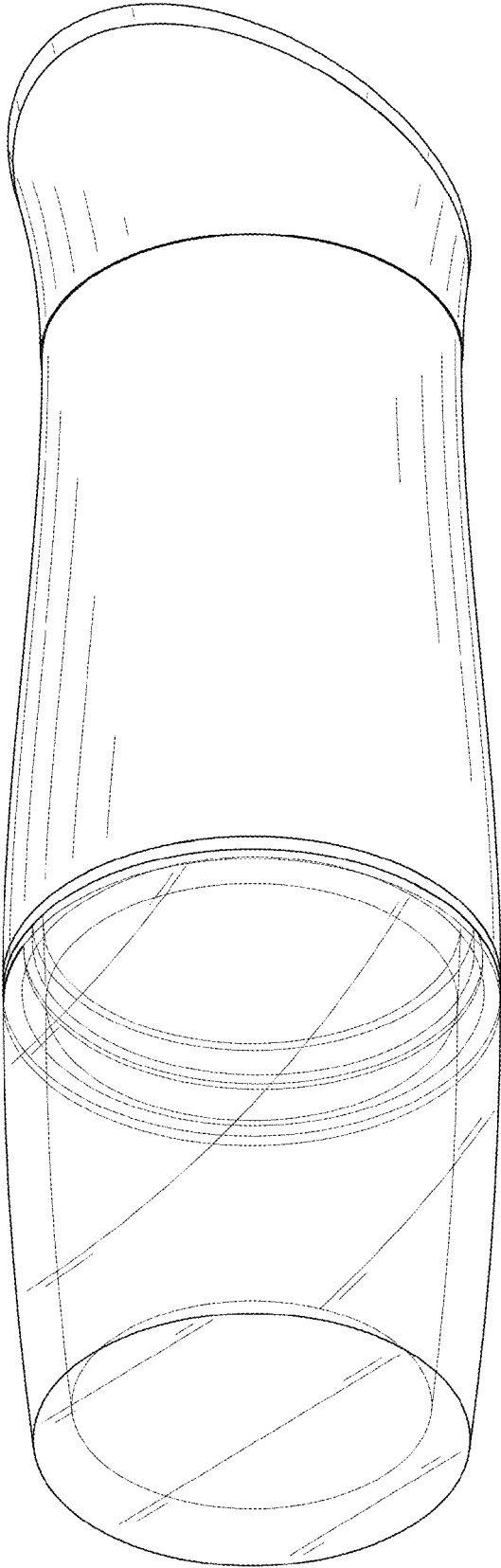

FIG. 2

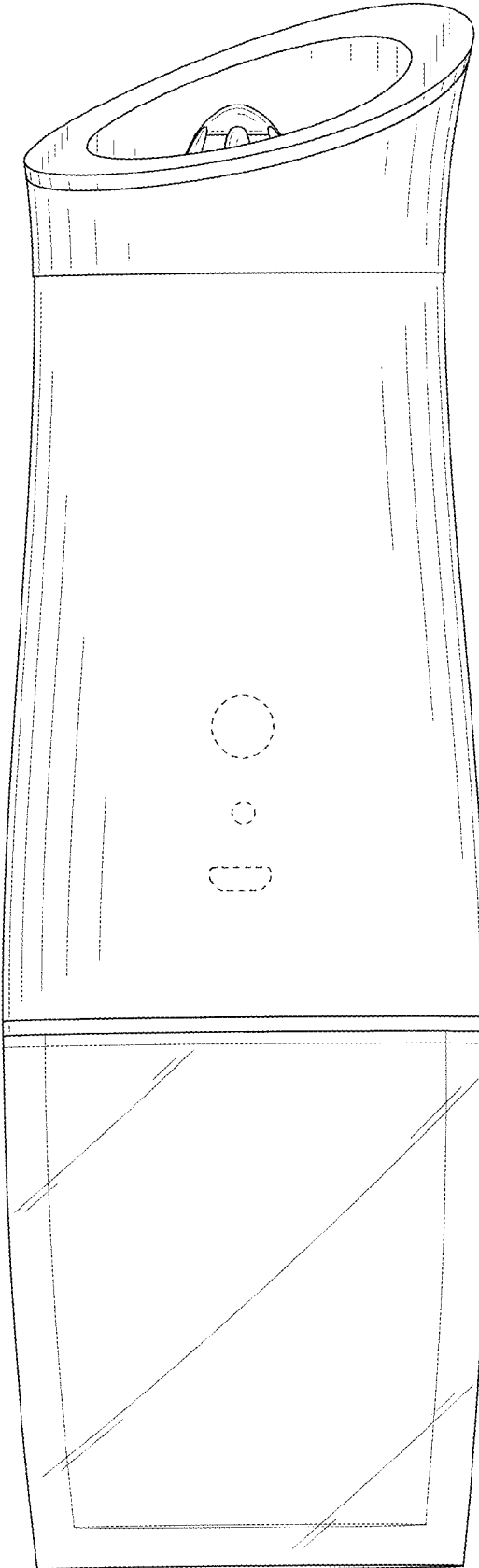

FIG. 3

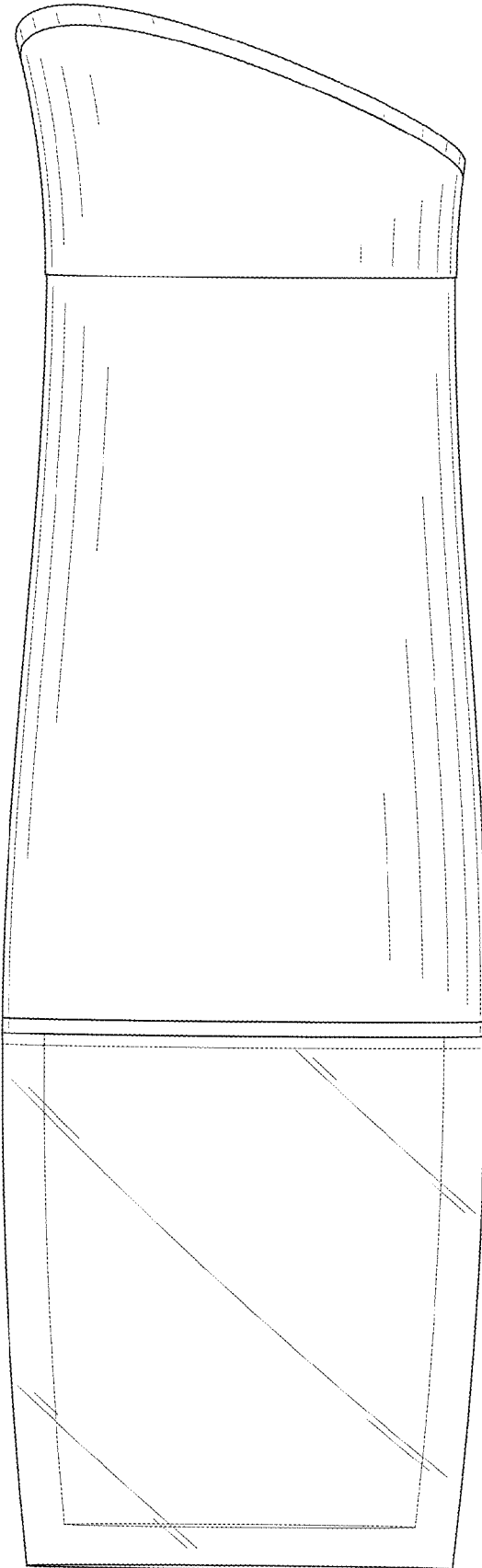

FIG. 4

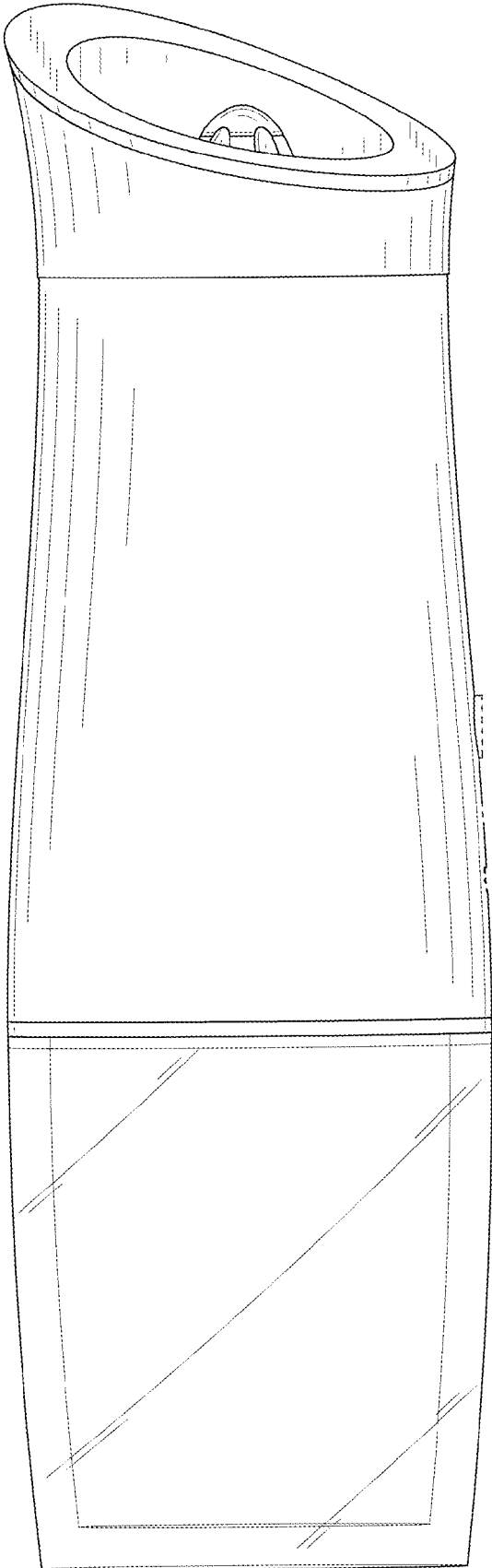

FIG. 5

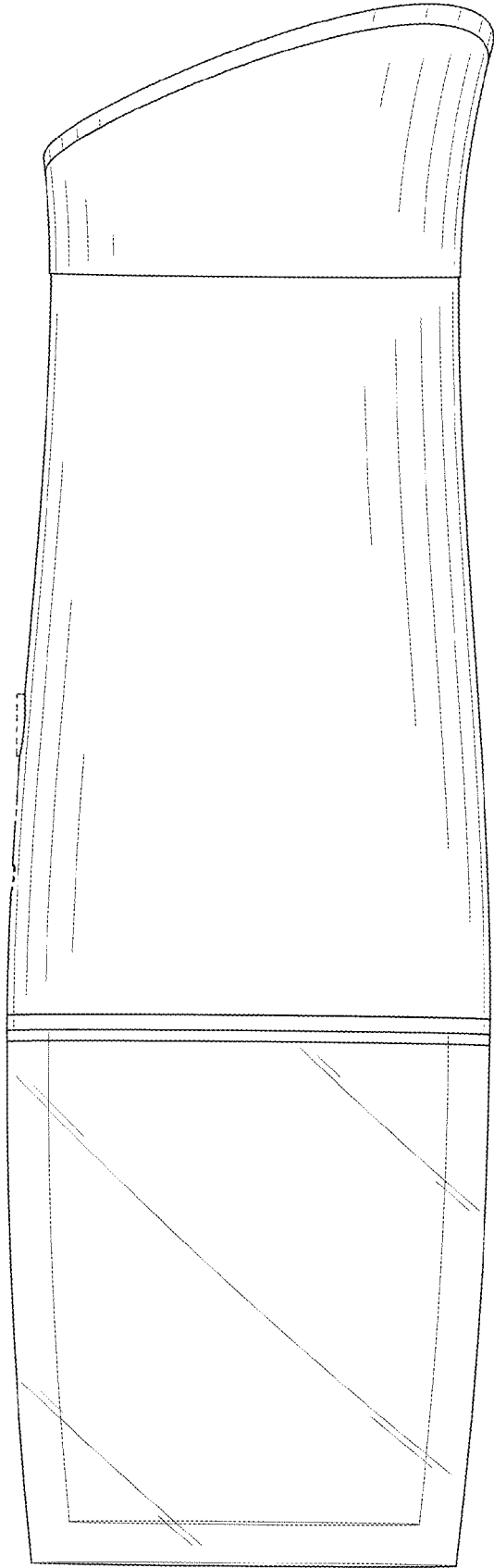

FIG. 6

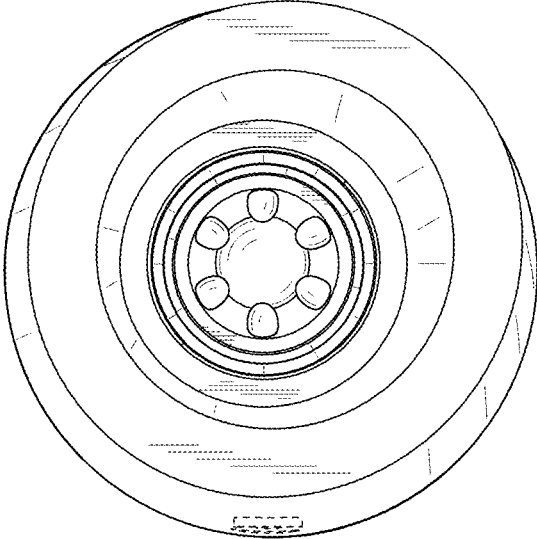

FIG. 7

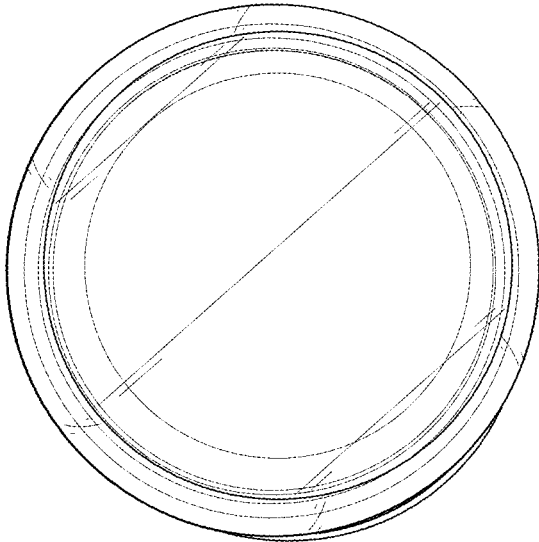

FIG. 8

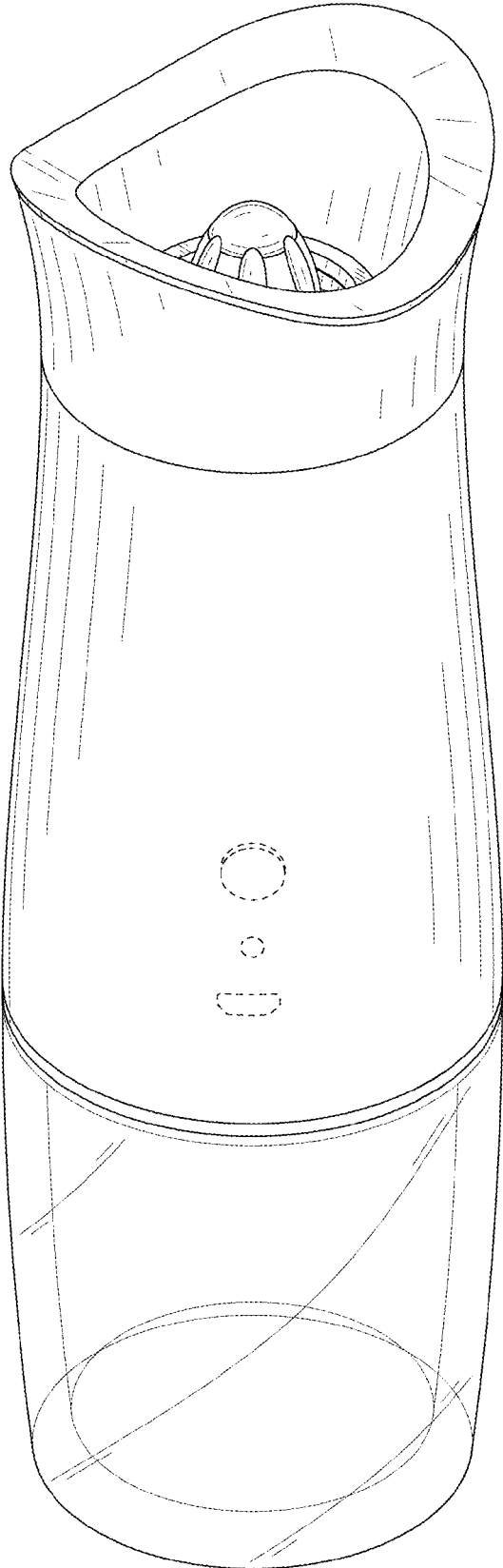

FIG. 9

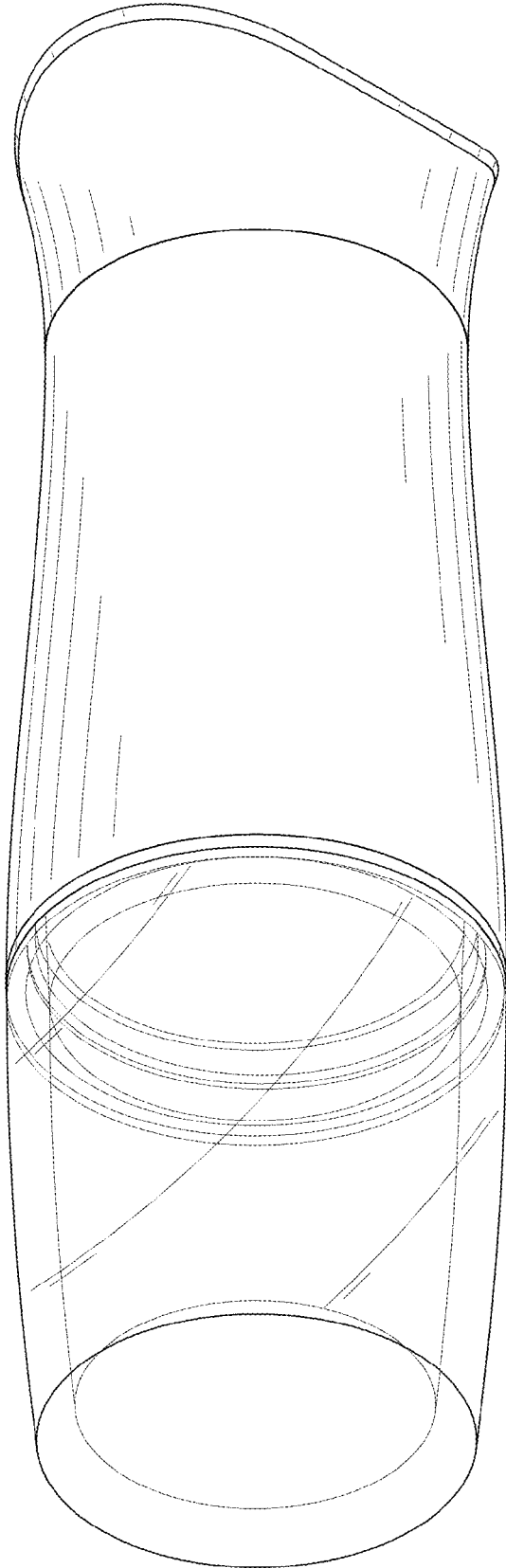

FIG. 10

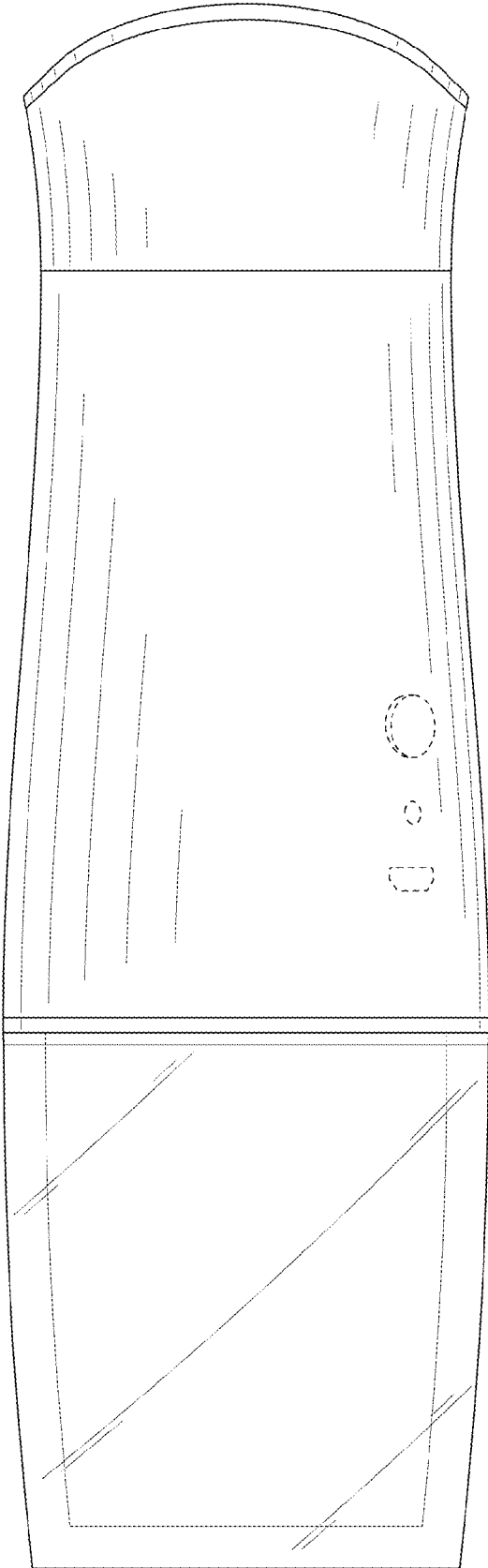

FIG. 11

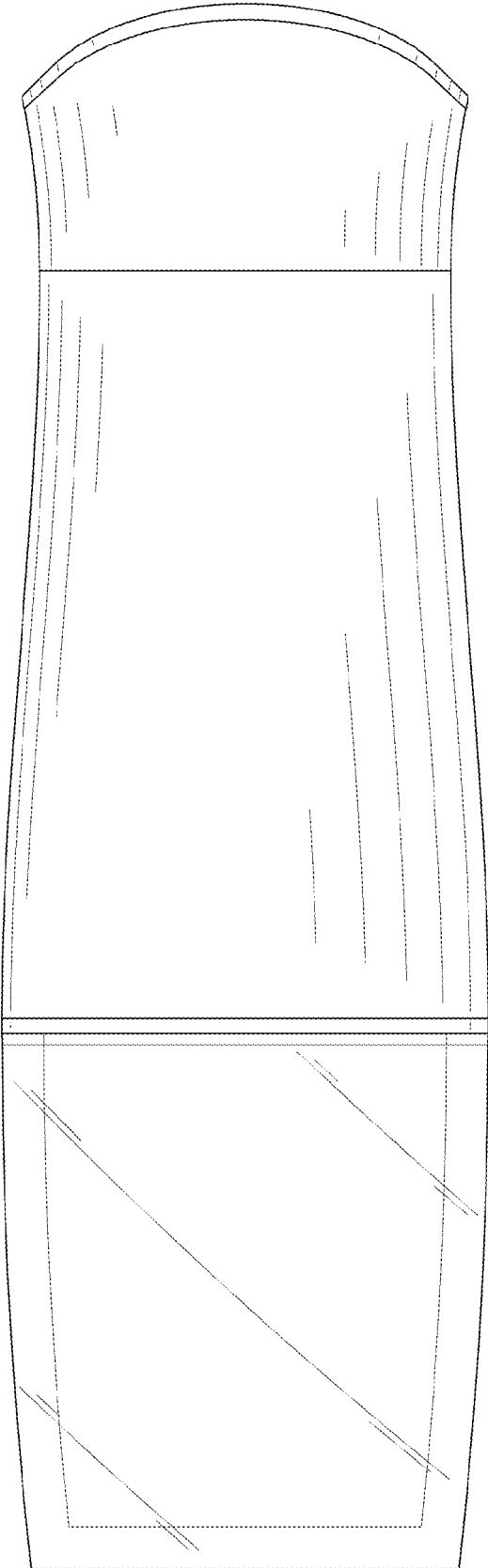

FIG. 12

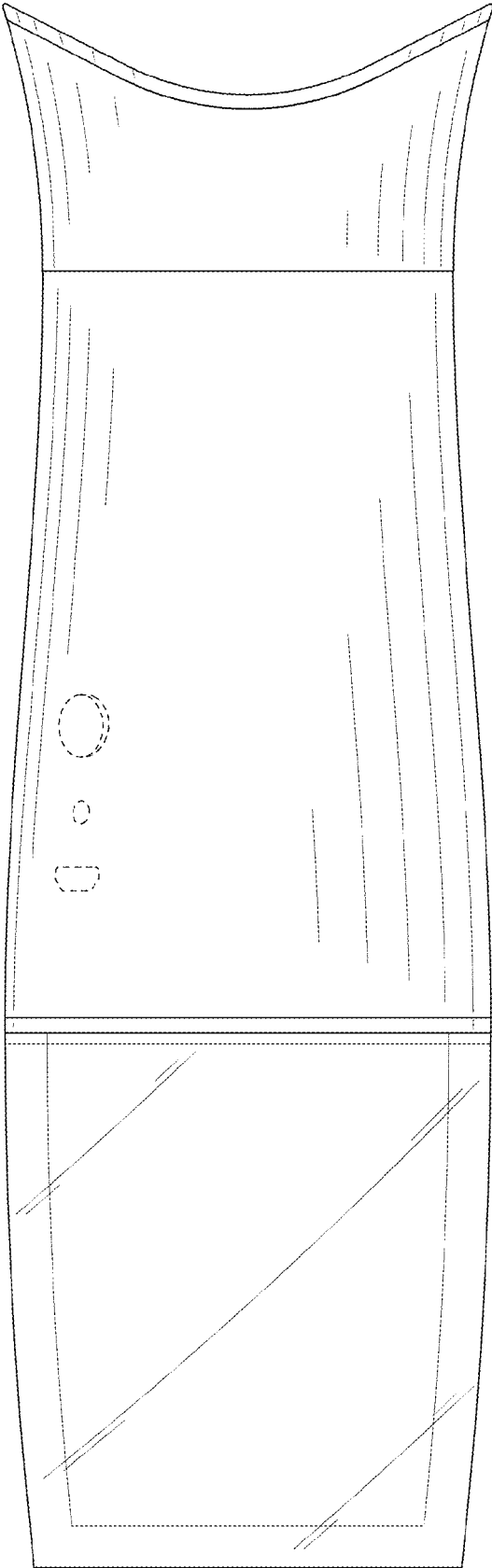

FIG. 13

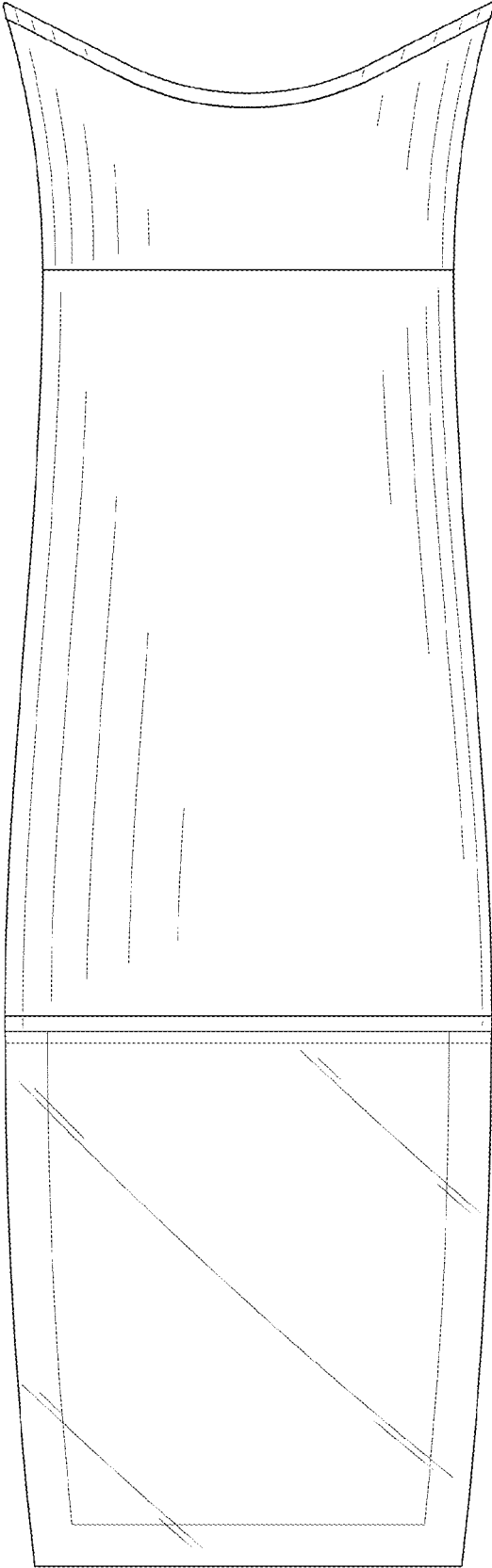

FIG. 14

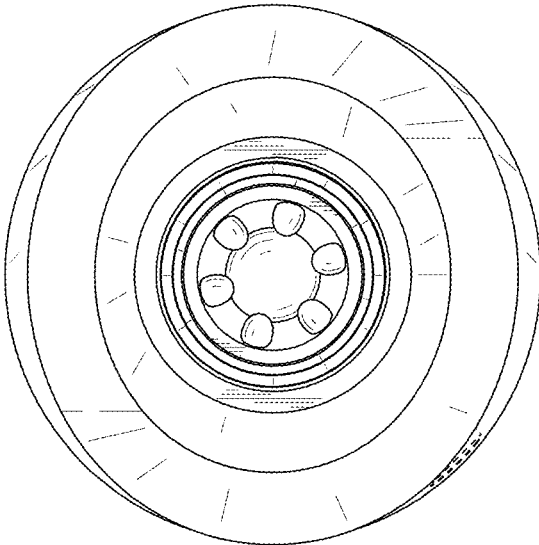

FIG. 15

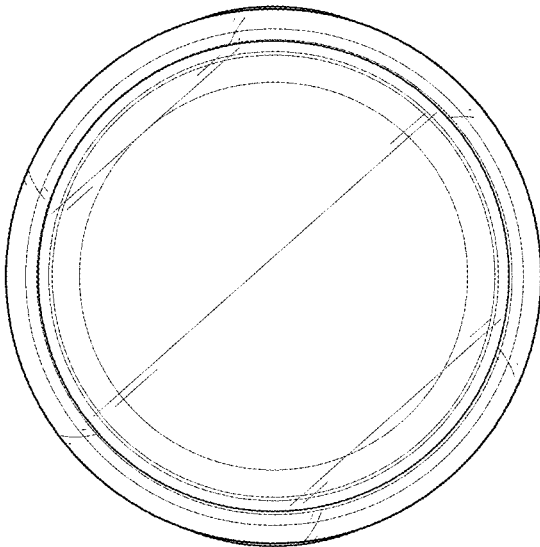

FIG. 16