

(12) INTERNATIONAL APPLICATION PUBLISHED UNDER THE PATENT COOPERATION TREATY (PCT)

(19) World Intellectual Property Organization
International Bureau



(43) International Publication Date
28 October 2010 (28.10.2010)

(10) International Publication Number
WO 2010/124093 A3

- (51) International Patent Classification:
G06Q 50/00 (2006.01)
- (21) International Application Number:
PCT/US2010/032057
- (22) International Filing Date:
22 April 2010 (22.04.2010)
- (25) Filing Language: English
- (26) Publication Language: English
- (30) Priority Data:
12/428,398 22 April 2009 (22.04.2009) US
12/428,283 22 April 2009 (22.04.2009) US
12/428,364 22 April 2009 (22.04.2009) US
12/428,349 22 April 2009 (22.04.2009) US
12/428,262 22 April 2009 (22.04.2009) US
12/428,382 22 April 2009 (22.04.2009) US
12/428,324 22 April 2009 (22.04.2009) US
12/428,302 22 April 2009 (22.04.2009) US
12/428,241 22 April 2009 (22.04.2009) US
- (72) Inventors; and
(75) Inventors/Applicants (for US only): **CARLSON, Mark** [US/US]; 153 Miramontes Avenue, Half Moon Bay, CA 94019 (US). **MOWZON, May, M.** [US/US]; 2471 W. Thompson Way, Chandler, AZ 85248 (US).
- (74) Agent: **WARD, John, P.**; Greenberg Traurig, LLP, 2450 Colorado Avenue, Suite 400 East, Santa Monica, California 94104 (US).
- (81) Designated States (unless otherwise indicated, for every kind of national protection available): AE, AG, AL, AM, AO, AT, AU, AZ, BA, BB, BG, BH, BR, BW, BY, BZ, CA, CH, CL, CN, CO, CR, CU, CZ, DE, DK, DM, DO, DZ, EC, EE, EG, ES, FI, GB, GD, GE, GH, GM, GT, HN, HR, HU, ID, IL, IN, IS, JP, KE, KG, KM, KN, KP, KR, KZ, LA, LC, LK, LR, LS, LT, LU, LY, MA, MD, ME, MG, MK, MN, MW, MX, MY, MZ, NA, NG, NI, NO, NZ, OM, PE, PG, PH, PL, PT, RO, RS, RU, SC, SD, SE, SG, SK, SL, SM, ST, SV, SY, TH, TJ, TM, TN, TR, TT, TZ, UA, UG, US, UZ, VC, VN, ZA, ZM, ZW.
- (84) Designated States (unless otherwise indicated, for every kind of regional protection available): ARIPO (BW, GH, GM, KE, LR, LS, MW, MZ, NA, SD, SL, SZ, TZ, UG, ZM, ZW), Eurasian (AM, AZ, BY, KG, KZ, MD, RU, TJ,

[Continued on next page]

(54) Title: TRIGGERED ANNOUNCEMENT

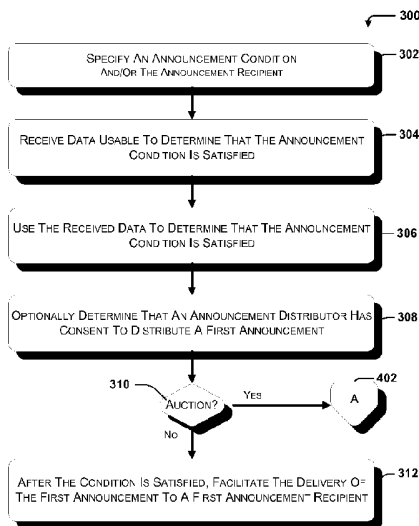

(57) Abstract: An announcement distributor distributes, or auctions an opportunity to distribute, an announcement to an announcement recipient such as a consumer, issuer, merchant, or acquirer within a payment processing system. The announcement when there has been a satisfaction of an announcement condition, such as the consumer being determined to be located within a predetermined spatial zone. The content of the announcement may, in turn, facilitate a subsequent cashless transaction for resources of merchants. Implementations describe various permutations of the content of the announcement, the announcement condition, and the announcement recipient.

Figure 3

WO 2010/124093 A3

WO 2010/124093 A3



TM), European (AT, BE, BG, CH, CY, CZ, DE, DK, EE, ES, FI, FR, GB, GR, HR, HU, IE, IS, IT, LT, LU, LV, MC, MK, MT, NL, NO, PL, PT, RO, SE, SI, SK, SM, TR), OAPI (BF, BJ, CF, CG, CI, CM, GA, GN, GQ, GW, ML, MR, NE, SN, TD, TG).

Published:

— *with international search report (Art. 21(3))*

(88) Date of publication of the international search report:

24 February 2011

TRIGGERED ANNOUNCEMENT**CROSS-REFERENCE TO RELATED APPLICATIONS**

This application claims priority to U.S. Application Serial No. 12/428,302, filed on April 22, 2009, titled "Receiving An Announcement Triggered By Location Data," U.S. Application Serial No. 12/428,349, filed on April 22, 2009, titled "Location Based Processing Of Announcements For Delivery To An Announcement Recipient," U.S. Application Serial No. 12/428,283, filed on April 22, 2009, titled "Receipt of Communications From Announcement Recipients of Consumer Data," U.S. Application Serial No. 12/428,324, filed on April 22, 2009, titled "Bidding To Receive Data After A Consumer Is In A Zone," U.S. Application Serial No. 12/428,262, filed on April 22, 2009, titled "Auctioning of Announcements," U.S. Application Serial No. 12/428,398, filed on April 22, 2009, titled "Providing An Announcement About Transactions Of A Target Merchant To A Consumer," U.S. Application Serial No. 12/428,241, filed on April 22, 2009, titled "Targeting Merchant Announcements Triggered by Consumer Activity Relative to a Surrogate Merchant," U.S. Application Serial No. 12/428,364, filed on April 22, 2009, titled "Notification of Resources of Interest To Members Of A Consumer Group," and U.S. Application Serial No. 12/428,382, filed on April 22, 2009, titled "Announcing Information about Payment Transactions of Any Member of A Consumer Group," each of which is incorporated herein by reference.

FIELD

Implementations generally relate to communicating information to facilitate a transaction, and more particularly, to announcing transaction information to an announcement recipient after an announcement condition has been satisfied.

BACKGROUND

Merchants spend a considerable amount of their investment dollars in marketing their resources to consumers. Often these marketing efforts are blind to the specific needs or preferences of the consumers they target, making them inefficient in influencing or predicting consumer purchasing decisions. Moreover, prediction of potential consumer purchasing decisions is further complicated when consumers make purchases for other consumers, such as gifts, or when consumers are influenced by other consumer's recommendations. Finally, a merchant's marketing efforts may not be executed at a time when a targeted consumer is susceptible to make a purchase.

On the other hand, many consumers now carry a portable consumer device capable of sending and receiving information, such as cellular telephones. Therefore, consumers are gaining access to more information as they make purchasing decisions. For example, a

consumer may access a search engine with a browser executing on a World Wide Web enabled cellular telephone to search for specified resources that may be sold by merchants. However, the information the consumer receives may not be well directed to the needs or preferences of the consumer.

5 Accordingly, it would be an advance in the art of commerce to provide timely and well tailored communications to facilitate subsequent transactions.

SUMMARY

In one implementation, the presence of a consumer within a zone is announced to an announcement recipient. An announcement condition that includes the presence of a first
10 consumer within the zone is specified. A determination is made as to whether the announcement condition has been satisfied by at least matching a location of the first consumer with a location within the zone. A transmission is formed including an announcement for delivery to the announcement recipient after the announcement condition has been satisfied.

In another implementation, an announcement recipient receives an announcement that a
15 consumer is located within a region that is of interest to a merchant. An announcement condition is specified to an announcement distributor. The announcement condition includes the presence of a first consumer within the region. The announcement is received by the announcement recipient from the announcement distributor after the announcement condition has been satisfied.

In yet a further implementation, indicia about a consumer is announced to an
20 announcement recipient. At least one announcement condition is specified by a user of an announcement system, including the user selecting the announcement recipient that is to receive the announcement when a consumer is present in a zone. The user then receives a communication from the announcement recipient after the announcement recipient has received the announcement.

In one implementation, the presence of a consumer within a zone is announced to an
25 announcement recipient. An announcement condition that includes the presence of a first consumer within the zone is specified. A determination is made as to whether the announcement condition has been satisfied by at least matching a location of the first consumer with a location within the zone. A transmission is formed including an announcement for delivery to the
30 announcement recipient after the announcement condition has been satisfied.

In one implementation, the presence of a consumer within a zone is announced to an announcement recipient. An announcement condition that includes the presence of a first consumer within the zone is specified. A determination is made as to whether the announcement condition has been satisfied by at least matching a location of the first consumer with a location

within the zone. A transmission is formed including an announcement for delivery to the announcement recipient after the announcement condition has been satisfied.

In another implementation, an announcement recipient receives an announcement that a consumer is located within a region that is of interest to a merchant. An announcement condition is specified to an announcement distributor. The announcement condition includes the presence of a first consumer within the region. The announcement is received by the announcement recipient from the announcement distributor after the announcement condition has been satisfied.

In yet a further implementation, indicia about a consumer is announced to an announcement recipient. At least one announcement condition is specified by a user of an announcement system, including the user selecting the announcement recipient that is to receive the announcement when a consumer is present in a zone. The user then receives a communication from the announcement recipient after the announcement recipient has received the announcement.

In one implementation, an announcement opportunity to have an announcement sent to an announcement recipient is auctioned to auction participants. The auction participants bid to receive the announcement when at least one specified condition occurs, including the presence of a consumer within a zone. The auction participant receives a notification when their bid to receive the announcement is a winning bid. After the at least one specified condition occurs, the winning auction participant, who is deemed to be the announcement recipient, then receives the announcement.

In another implementation, announcement opportunities to communicate with at least one consumer when a specified condition occurs are auctioned to a plurality of auction participants. The specified condition includes the presence of the consumer in a zone and at least one auction participant having a winning bid. After the specified condition occurs, a communication to the consumer from the auction participant having the winning bid is facilitated or enabled.

In one implementation, an announcement opportunity to have an announcement sent to an announcement recipient is auctioned to auction participants. The auction participants bid to receive the announcement when at least one specified condition occurs, including the presence of a consumer within a zone. The auction participant receives a notification when their bid to receive the announcement is a winning bid. After the at least one specified condition occurs, the winning auction participant, who is deemed to be the announcement recipient, then receives the announcement.

In another implementation, announcement opportunities to communicate with at least one consumer when a specified condition occurs are auctioned to a plurality of auction participants.

The specified condition includes the presence of the consumer in a zone and at least one auction participant having a winning bid. After the specified condition occurs, a communication to the consumer from the auction participant having the winning bid is facilitated or enabled.

5 In one implementation, the presence of a consumer within a zone is announced to an announcement recipient. An announcement condition that includes presence of a first consumer within the zone is specified. A determination is made as to whether the announcement condition has been satisfied by at least matching a location of the first consumer with the zone. A transmission is formed including an announcement for delivery to the announcement recipient after the announcement condition has been satisfied.

10 In another implementation, an announcement recipient receives an announcement that a consumer is located within a region that is of interest to a merchant. An announcement condition is specified to an announcement distributor. The announcement condition includes presence of a first consumer within the region. The announcement is received from the announcement distributor after the announcement condition has been satisfied.

15 In yet a further implementation, indicia about a consumer is announced to an announcement recipient. At least one announcement condition is specified by a user of an announcement system, including the user selecting the announcement recipient that is to receive the announcement when a consumer is present in a zone. The user then receives a communication from the announcement recipient after the announcement recipient has received
20 the announcement.

In another implementation, an announcement from a targeting merchant is provided to a consumer. Transaction information for transactions between merchants and a consumer is electronically received. The transaction information includes a merchant identifier usable to identify the merchants associated with corresponding transactions. An announcement condition
25 is specified, wherein the announcement condition includes occurrence of at least one transaction between a second, surrogate merchant and the consumer. The announcement condition is established as being satisfied by at least determining that a merchant identifier of the surrogate merchant matches the merchant identifier in the received the transaction information. A transmission is formed, wherein the transmission includes the announcement from the targeting
30 merchant for delivery to the consumer after the announcement condition is satisfied.

In yet another implementation, the announcement opportunity to have the announcement sent to the announcement recipient is auctioned to auction participants. The auction participants bid to receive the announcement when at least one specified condition occurs, including presence of the consumer within a zone. The auction participant receives a notification that the

corresponding bid to receive the announcement is a winning bid. The auction participant then receives the announcement after the specified condition occurs.

In another implementation, announcement opportunities to communicate with consumers are auctioned to a plurality of auction participants. A plurality of auction participants bid for the announcement opportunity to communicate with at least one consumer when a specified condition occurs. The specified condition includes presence of the consumer in a zone and at least one auction participant having a winning bid. After the specified condition occurs, a communication to the consumer from the auction participant having the winning bid is facilitated or enabled.

In another implementation, a shopper is provided information about at least one transaction involving a target merchant. Transaction information for a plurality of transactions is received. Each transaction occurs between a merchant and a consumer for a resource. The transaction information includes an indicator usable to identify the merchant associated with the transaction. A query is received from the shopper, requesting information about at least one transaction involving the target merchant. The indicators are used to identify at least one transaction involving the target merchant. A message is formed based on the identified transaction, for delivery to the shopper.

In one implementation, a targeting merchant has its announcement delivered to a consumer when the consumer conducts a transaction with a specific surrogate merchant. Transaction information is electronically received for each of a plurality of transactions between surrogate merchants and the consumer. Included in the transaction information for each transaction is a surrogate merchant identifier that can be used to identify each surrogate merchant. In this implementation, an announcement condition is satisfied by the consumer conducting a transaction with the specific surrogate merchant, thereby triggering the delivery of the target merchant's announcement to the consumer.

In one implementation, a member consumer is notified of purchases made by other member consumers in a consumer group, where each purchase was conducted upon a corresponding account that was issued to another member consumer by an issuer. In this implementation, the member consumer first selects the member consumers that are in the consumer group, and then sends a query requesting information about the purchases of other member consumers. The query includes a code usable to distinguish past purchases made by other member consumers. The requesting member consumer, in response, receives a notification of purchases made by other member consumers in the consumer group as are distinguished by use of the code.

In another implementation, a member consumer is notified of purchases made by other member consumers in a consumer group from any of a plurality of merchants. To do so, resource data is collected that identifies a resource set that includes resources of interest to at least one of the member consumers. Transaction information is also collected about purchases by the member consumers from the plurality of merchants. The collected transaction information includes information about the resources of each purchase, such as a Stock Keeping Unit (SKU). At least a portion of the information about the resources of each purchase is compared to the resources in the resource set to identify a match. For each match, one or more member consumers are notified of purchases made from any of the plurality of merchants by other member consumers in the consumer group.

In one implementation, a consumer is notified of purchases made by any member consumer in a consumer group. The purchases are each upon a corresponding account that is issued to the member consumer by an issuer. A consumer selects the member consumers that are in the consumer group. One of the member consumers forms a query requesting information about the purchases of any of the member consumers. The query includes a code usable to distinguish the purchases made by the member consumers. The requesting consumer, in turn, receives the announcement including the information about the purchases that are distinguished by using the code.

BRIEF DESCRIPTION OF THE DRAWINGS

Implementations will become more apparent from the detailed description set forth below when taken in conjunction with the drawings, in which like elements bear like reference numerals.

Figure 1 depicts a block diagram illustrating an exemplary environment in which an announcement recipient receives an announcement;

Figure 2 depicts a block diagram illustrating an exemplary payment processing system that can be operated in the environment of Figure 1;

Figure 3 depicts a flowchart of an exemplary method, that can be performed in the environment of Figure 1, for an announcement distributor to provide the announcement to the announcement recipient;

Figure 4 continues the flowchart in Figure 3, wherein the announcement distributor auctions the announcement to the announcement recipient;

Figure 5 depicts a flowchart of an exemplary method, that can be performed in the environment of Figure 1, for notifying a member consumer in a consumer group of purchases

from any of a plurality of the merchants that are made by any other member consumer in the consumer group;

Figure 6 continues the flowchart in Figure 5, wherein the announcement is triggered by one of the member consumers engaging in a transaction;

5 Figure 7 continues the flowchart in Figure 5, wherein the announcement is triggered by the presence of one of the member consumers in a zone; and

Figure 8 depicts a block diagram of yet another exemplary payment processing system that can be operated in the environment of Figure 1.

DETAILED DESCRIPTION

10 A consumer and a merchant engage in a transaction for the purchase of a resource, such as a good and/or a service. The transaction or “purchase” can be a sale, a lease, a rental, an assignment, and/or a license, where some form of currency (*e.g.*, money, “points” in a loyalty program, minutes for cellular telephony air time usage) is given the consumer to the merchant to purchase the resource. Alternatively, the transaction may also be gratuitous, such as a donation
15 to a charitable organization, where the consumer is the donor and the charitable organization is the merchant receiving the donation. The consumer may be a person, an entity, or a group of persons or entities. The merchant may be, for example, a retailer, a wholesaler, a reseller, a manufacturer, a broker, a distributor, a provider, a charitable organization, or any entity in the distribution chain of resources. In a business-to-business environment, a first merchant may
20 engaged in the transaction with the consumer that is a second merchant, such as a small business to whom the first merchant is a supplier of resources.

Methods, apparatus, systems, and transformations of particular articles to different states or things are disclosed, wherein a tailored announcement is timely sent to entities, such as consumers or merchants, in a chain of commerce to facilitate a subsequent transaction. The
25 announcement may include information, for example, such as: a purchase price of a resource purchased in the past; a real-time location of the consumer, an indication of a number of times that the consumer has been in a spatial zone over a window of time; a transaction history of a targeted consumer; a sequential shopping pattern of multiple consumers; a coupon of a merchant; a report on past announcements sent to announcement recipients; or a combination of the
30 forgoing.

Implementations for disseminating an announcement include various permutations of: variations on the content of the announcement, variations on an announcement condition that triggers the sending of the announcement, and variations on an announcement recipient receiving the announcement. For example, in one such implementation, the announcement is sent

informing a merchant that a consumer, with a particular purchasing history, is located within a spatial zone of interest to that merchant. In another such implementation, the announcement is not directly sent to the announcement recipient, but is auctioned off to bidders each submitting a bid for the right to be sent their announcement to the announcement recipient. In yet another such implementation, the consumer requests and receives the announcement that indicates characteristics of past transactions of a specified merchant. In yet a further implementation, a set of resources of interest to a group of consumers is specified, the set is modified as the consumers within the group make purchases of the resources in the set, and the consumers in the group receive the announcement containing the modified set of resources.

Referring to Figure 1, a block diagram illustrates an exemplary environment in which an announcement recipient receives an announcement by an announcement system 100. The announcement system 100 includes at least one consumer (c) 102 (*e.g.*, the consumer) such as consumer (1) 102 through consumer (C) 102, where C can be up to and greater than an eight digit integer; at least one merchant (m) 104 (*e.g.*, the merchant) such as merchant (1) 104 through merchant (M) 104, where M can be up to and greater than an eight digit integer; and at least one host (h) 106 such as host (1) 106 through host (H) 106, where H can be up to and greater than an eight digit integer (collectively “users”). The host (h) 106 may be an entity that utilizes a computer to receive and transmit data, store data, or execute algorithms (*e.g.*, software), such as to compare the received data to the stored data. For example, the host (h) 106 may utilize a computer to execute an algorithm to determine if the announcement condition has been satisfied and to facilitate the transfer (*e.g.*, transmission or broadcasting) of the announcement to the announcement recipient, such as the consumer (c) 102 or the merchant (m) 104.

The announcement system 100 may have at least one database DB 110. As appreciated by those skilled in the art, the DB 110 or components thereof may be any combination of databases, or the components thereof, in a single location or in multiple locations. Data stored in the DB 110 may be structured by a database model, such as a relational model or a hierarchical model, where the model may govern how the data stored in the DB 110 may be accessed. For example, query languages can be used to query the data stored in the DB 110 to locate records, or portions thereof, that are relevant to the query. DB 110 may include any of a variety of security features such as: access codes, firewalls, compression, decompression, encryption, de-encryption, or the like.

The data stored in the DB 110 may include information about the consumer (c) 102, the merchant (m) 104, the host (h) 106, or others, for example. This stored data may include: transaction information about transactions between the consumer (c) 102 and the merchant (m)

104; corporate records; information received from a user of announcement system 100, such as through a profile created by the user; or information purchased from external sources who supply such information. To illustrate, the transaction information may include trends in a transaction history of an account issued to the consumer (c) 102 by an issuer. The corporate records may include a location of the merchant (m) 104. A user profile of the merchant (m) 104 may include a merchant category of the merchant (m) 104, or a merchant identifier of the merchant (m) 104. The information purchased from an external source may include a Fair Isaac Corporation (FICO) score of the consumer (c) 102.

In one implementation, an inventory management system (IMS) of the merchant (m) 104 is connected to the announcement system 100 such that data about the resources of merchant (m) 104 in the IMS may flow to the DB 110. The merchant (m) 104 may use the IMS to track the flow of resources within the inventory of the merchant (m) 104. The IMS may include a computer software program capable of accessing a merchant database containing data about the resources within the inventory of the merchant (m) 104. The IMS may have a graphical user interface (“GUI”) enabling the merchant (m) 104 to enter, delete, and analyze the data about the resources. The computer software program within the IMS may provide the capability of associating a description with an inventory item within the inventory of the merchant (m) 104, such as a category for the inventory item. The IMS may automatically transmit the data about the resources of the merchant (m) 104 to the DB 110 according to a pre-selected workflow.

Each user of announcement system 100 may be communicatively connected via a network Net 108 through a network device such as Net (1) 108 through Net (N) 810, where N can be up to and greater than an eight digit integer. Each Net (n) 108 may represent any of a variety of suitable means for exchanging data, such as: an Internet, an intranet, an extranet, a wide area network (WAN), a local area network (LAN), a virtual private network, a satellite communications network, an Automatic Teller Machine (ATM) network, an interactive television network, or any combination of the forgoing. Net (n) 108 may contain either or both wired and wireless connections for the transmission of signals including electrical, magnetic, and a combination thereof. Examples of such connections are known in the art and include: radio frequency connections, optical connections, etc. To illustrate, the connection for the transmission of signals may be a telephone link, a Digital Subscriber Line, or cable link. Moreover, Net (n) 108 may utilize any of a variety of communication protocols, such as Transmission Control Protocol/Internet Protocol (TCP /IP), for example.

Each Net (n) 108 may connect one or more users. For example, the consumer (c) 102 may be connected to the host (h) 106 via Net (n) 108, a satellite communication network, while

the merchant (m) 104 may be connected to the host (h) 106 via Net (2) 108, an Internet communication network. Data flows between users of the announcement system 100 through their respective connections to one or more network devices (*e.g.*, Net (n) 108)) that are networked within the network Net 108 in the announcement system 100.

5 There may be multiple nodes within the network Net 108, each of which may conduct some level of processing on the data transmitted within the announcement system 100. For example, a node within the Net (n) 108 may be a bank connecting the merchant (m) 104 to the host (h) 106. The bank, or other nodes, may also be one of the users of the announcement system 100.

10 The users of the announcement system 100 may communicate with one another through Net 108 and/or via communication channels. For example, consumer (c) 102 may communicate with: merchant (m) 104 via a channel 116; or host (h) 106 via channel 112, Net (n) 108, and a channel 118. Each communication channel in Figure 1 is shown as a double arrow representing a plurality of signal and bidirectional communication channels. For example, the merchant (m)
15 104 may transmit data to the Net (1) 108 via channel 114 and receive data back from Net (2) 108 via channel 114. Similarly, consumer (1) 102 may communicate with consumer (2) 102 via a communication paths involving channel 112 and Net (n) 108.

 Users of the announcement system 100 may interact with one another or receive data about one another within the announcement system 100 using any of a variety of communication
20 devices. The communication device may have a processing unit operatively connected to a display and memory such as Random Access Memory (“RAM”) and/or Read-Only Memory (“ROM”). The communication device may be a combination of hardware and software that enables an input device such as a keyboard, a mouse, a stylus and touch screen, or the like.

 Use of the announcement system 100 by consumer (c) 102 may include the use of a
25 portable consumer device (PCD). The PCD may be a communication device, or may be used in conjunction with, or as part of, the communication device. Examples of the PCD include any of: a card (*e.g.*, bank card, payment card, financial card, credit card, charge card, debit card, gift card, bus pass, smart card, access card, security card, healthcare card, or telephone card), a tag, a wristwatch, a key ring, a fob (*e.g.*, SPEEDPASS® commercially available from ExxonMobil
30 Corporation), a pager, a cellular telephone, a personal digital assistant, a digital audio player, a computer (*e.g.*, laptop computer), a set-top box, a portable workstation, a minicomputer, or a combination thereof. The PCD may have near field or far field communication capabilities (*e.g.*, satellite communication or communication to cell sites of a cellular network) for telephony or data transfer such as communication with a global positioning system (GPS). The PCD may

support a number of services such as Short Message Service (SMS) for text messaging and Multimedia Messaging Service (MMS) for transfer of photographs and videos, electronic mail (e-mail) access.

The PCD may include a computer readable medium. The computer readable medium, such as a magnetic stripe or a memory of a chip or a chipset, may include a volatile, a non-volatile, a read only, or a programmable memory that stores data, such as an account identifier, a consumer identifier, and/or an expiration date. The computer readable medium may include executable instructions that, when executed by a computer, the computer will perform a method. Examples of the PCD with memory and executable instructions include: a smart card, a personal digital assistant, a digital audio player, a cellular telephone, a personal computer, or a combination thereof. To illustrate, the PCD may be a financial card that can be used by a consumer to conduct a contactless transaction with a merchant, where the financial card includes a microprocessor, a programmable memory, and a transponder (*e.g.*, transmitter or receiver). The financial card can have near field communication capabilities, such as by one or more radio frequency communications such as are used in a "Blue Tooth" communication wireless protocol for exchanging data over short distances from fixed and mobile devices, thereby creating personal area networks (PANs).

Similarly, the merchant (m) 104 may interact with either the host (h) 106 or the consumer (c) 102 via a communication device, such as a Point of Interaction. A Point of Interaction (POI) can be a physical or virtual communication vehicle that provides the opportunity, through any channel (112, 114, 116, 118) to engage with the consumer (c) 102 or the host (h) 106 for the purposes of providing content, messaging or other communication, related directly or indirectly to the facilitation or execution of a transaction between the merchant (m) 104 and the consumer (c) 102. Examples of the POI include: a physical or virtual Point of Service (POS) terminal, the PCD of the consumer (c) 102, a portable digital assistant, a cellular telephone, paper mail, e-mail, an Internet website rendered via a browser executing on computing device, or a combination of the forgoing.

The PCD may interface with the POI using a mechanism including any suitable electrical, magnetic, or optical interfacing system such as a contactless system using radio frequency, a magnetic field recognition system, or a contact system such as a magnetic stripe reader. To illustrate, the POI may have a magnetic stripe reader that makes contact with the magnetic stripe of a healthcare card (*e.g.*, Flexible Savings Account card) of the consumer (c) 102. As such, data encoded in the magnetic stripe on the healthcare card of consumer (c) 102 read and passed via channel 116 to the POI at merchant (m) 104. These data can include an account identifier of a

healthcare account. The POI can then form a transmission including the account identifier for delivery to the host (h) 106 via channels 114, through Net (n) 108, and channel 118. In another example, the POI may be the PCD of the consumer (c) 102, such as the cellular telephone of the consumer (c) 102, where the merchant (m) 104, or an agent thereof, receives the account identifier of the consumer (c) 102 via a webpage of an interactive website rendered by a browser executing on a World Wide Web (Web) enabled PCD.

In some implementations, the announcement system 100 can include, or be included within, a payment processing system that includes a plurality of financial institutions (*e.g.*, banks, credit unions, savings and loan institutions, brokerages, etc.) and at least one transaction handler, wherein users of the announcement system include: the transaction handler, the financial institutions, the consumer (c) 102, and the merchant (m) 104. Examples of payment processing systems include VisaNet® network, the American Express® network and the Veriphone® network. In some implementations, the financial institution and/or the transaction handler may provide at least some of the functions of the host (h) 106.

An Exemplary Payment Processing System

A payment processing system facilitates the processing of cashless transactions conducted through the use of an account such as a checking account, a line of credit, or a loyalty account wherein points are redeemed (*e.g.*, 50 reward points in a loyalty program are equal to \$20(US) toward a purchase). Other examples of the accounts include: debit, revolving credit, charge, stored-value, prepaid (*e.g.*, reloadable account, Flexible Spending Account, Healthcare Savings Account), gift, commercial, corporate, government, or a combination thereof. An issuer (*e.g.*, one of the financial institutions in the payment processing system) may issue the account to the consumer (c) 102.

An exemplary payment processing system 200 is depicted in Figure 2. The payment processing system 200 includes at least one issuer (i) 202 (*e.g.*, the issuer) such as issuer (1) 202 through issuer (i) 202, where “I” can be up to and greater than an eight digit integer; at least one transaction handler (th) 206 (*e.g.*, the transaction handler) such as transaction handler (1) 206 through transaction handler (TH) 206, where TH can be up to and greater than an eight digit integer; at least one acquirer (q) (*e.g.*, the acquirer) such as acquirer (1) 204 through acquirer (Q) 204, where Q can be up to and greater than an eight digit integer; the merchant (m) 104; and the consumer (c) 102. The consumer (c) 102 may be an account holder of the account issued by the issuer (i) 202, such as a joint account holder, or someone with access to the account, such as an employee with access to a corporate account. The acquirer (q) 204 and the issuer (i) 202 can

communicate with the other users (102, 104, 206) of the payment processing system 200 via Net (n) 108.

The account may be associated with an account identifier. The account identifier may be, for example, any code, symbol, number, letter, digital signal, analog signal, digital certificate, biometric code, or other indicia usable to distinguish or identify the consumer (c) 102 or a corresponding account of the consumer (c) 102. Nonetheless, the account identifier of the account may be used to distinguish the past transactions of the consumer (c) 102 without knowing the identity of the consumer (c) 102, such as the legal name of the consumer (c) 102. For example, if ten of the past transactions of the consumer (c) 102 stored in the DB 110 were each conducted upon the account with the account identifier "4234567890123456," then each of the ten past transactions can be distinguished by filtering the data in the DB 110 using the account identifier "4234567890123456," even without knowing the legal name of the consumer (c) 102 to whom the account was issued by issuer (i) 202.

The account identifier can be used for purposes other than distinguishing the account, activities on the account, or the consumer (c) 102 within the payment processing system 200. For example, the account identifier may be a numeric code, wherein the first six numbers are a Bank Identification Number (BIN) that denotes the issuing bank and the category of the account associated with the account identifier (e.g., "gold card" account).

Typically, a transaction begins with consumer (c) 102 presenting an account identifier of an account of consumer (c) 102 to merchant (m) 104 to initiate an exchange of currency for a resource. Other data that may be presented to merchant (m) 104 may include an expiration date, a consumer name of the consumer (c) 102, and/or a Personal Identification Number (PIN). The transfer of data may be in any format recognizable by the merchant (m) 104, such as in a magnetic stripe track data format. For example, the consumer may present a PCD that is associated with the account to the POI of the merchant (m) 104 by swiping a plastic card in a magstripe card reader at the POI or by bringing an RFID enabled PCD in an effective proximity of an RFID reader so as to be interrogated.

Thereafter, the merchant (m) 104 may use the POI to form an authorization request that may including transaction information about the resource being purchased and the account identifier received from the consumer (c) 102. The transaction information may have several data fields. For example, as is known by those of ordinary skill in the relevant art, the data fields may include: a name of the consumer (c) 102, the account identifier (e.g., Primary Account Number or "PAN"), an expiration date of the PCD, a Card Verification Value (CVV), a Personal Identification Number (PIN), a discretionary code of the issuer of the account, a date, a time of

the transaction, a merchant identifier (*e.g.*, merchant indicator) of the corresponding merchant (m) 104, data usable to determine a location of the merchant (m) 104, a POI identifier, a total transaction amount, a Universal Product Code of the resource being purchased, a Stock Keeping Unit of the resource being purchased, a promotion code, or an acquirer code of the acquirer (q) 204 associated with the corresponding merchant (m) 104.

The authorization request may be communicated to the acquirer (q) 204, via Net (n) 108 using channels 114, 210. The acquirer (q) 204 forwards the authorization request, and perhaps other information, to transaction handler (th) 206 via Net (n) 108 using, for example, channels 210, 118. Transaction handler (th) 206 may, in turn, forward the authorization request, and perhaps other information, to the issuer (i) 202 that issued the account via channels 118, 208. In some implementations, the transaction handler (th) 206 may forward the authorization request to another transaction handler (th+1) 206 who then forwards the authorization request to issuer (i) 202.

An authorization response is transmitted in response to the authorization request. An authorization response includes the issuer (i) 202, or the transaction handler (th) 206 on behalf of the issuer (i) 202, authorizing the transaction in connection with business rules for authorization. For example, the issuer (i) 202 may determine that the account has enough funds to cover paying for the resources being purchased or that the transaction has a low risk of fraud based on a determined location of the merchant (m) 104 that is conducting the transaction with consumer (c) 102. Thereafter, the issuer (i) 202 may form the authorization response for delivery to the transaction handler (th) 206. The transaction handler (th) 206 may forward the authorization response to the acquirer (q) 204, who in turn forwards the authorization response to merchant (m) 104. Once approved, merchant (m) 104 may record the authorization and provide the resource to the consumer (c) 102.

The merchant (m) 104 may, at discrete periods, such as the end of the day, submit a list of authorized transactions to the acquirer (q) 204 for clearing and settlement. The acquirer (q) 204, in turn, requests clearing and settlement from the transaction handler (th) 206. The transaction handler (th) 206 may, but need not, compare the submitted authorized transaction list with its own log of authorized transactions to find matches. The transaction handler (th) 206 may, in turn, route the clearing and settlement request from the corresponding acquirer (q) 204 to the corresponding issuer (i) 202 that is involved in the corresponding transaction. Once the acquirer (q) 204 receives the funds from the account upon which the transaction was conducted, where the funds received from issuer (i) 202 matches a payment for the purchased resource, acquirer (q) 204 can make the funds available to the merchant (m) 104 less any transaction costs,

such as fees. If the transaction involves a debit or pre-paid account, the acquirer (q) 204 may choose not to wait for the transfer of funds prior to paying the merchant (m) 104.

There may be intermittent steps in the foregoing process, some of which may occur simultaneously. For example, the issuer (i) 202 may transfer the funds to a clearing bank, which
5 in turn, sends the funds to a settling bank that forwards the funds to the corresponding merchant (m) 104.

The transaction handler (th) 206 may maintain a log or history of the transactions as they pass through the payment processing system 200. In one implementation, the transaction handler (th) 206 may store the transaction information received during the processing of the transaction
10 in the DB 110, such as: the transaction information received in the authorization request, the authorization response, or data received during the clearing and settlement process.

As stated previously, the data stored in the DB 110 in association with the consumer (c) 102 or the account of the consumer (c) 102, may include information about the consumer, such as demographics data for the consumer (c) 102 or data derived from information about the past
15 transactions of consumer (c) 102, hereinafter "transaction information". Data derived from transaction information may include: a result from a bankruptcy predictor algorithm, predicting the likelihood that a particular of the consumer (1) 102 may file bankruptcy within a window of time; or a history of frequently purchased resources paid for through the use of the account of the consumer (1) 102, for example. This data may be derived through quantitative or qualitative
20 research, market segment analysis, statistical modeling, regression analysis, econometrics, or data mining analysis, for example.

The payment processing system 200 can be operated in the environment of Figure 1 to perform functions of announcement system 100. The users (*e.g.*, the consumer (c) 102, the issuer (i) 202, the merchant (m) 104, the acquirer (q) 204, and/or the transaction handler (th)
25 206) in the payment processing system 200 may communicate with one another via Net 108 thereby transmitting or receiving information, such as the transaction information stored in the DB 110.

Delivery of Announcement to Announcement Recipient

The user may select the content of the announcement, the announcement condition and/or
30 the announcement recipient. Thereafter, an announcement distributor (*e.g.*, host (h) 106) sends the announcement to the selected announcement recipient after the announcement condition is satisfied.

The announcement condition may be selected based on the user's desired targeting goals. The targeting goals may focus on the timing of the delivery of the announcement, the relevance

of the content of the announcement to the activities of the announcement recipient, or the location of the announcement recipient at the time the announcement recipient is to receive the announcement. For example, one of the targeting goals may be to send the announcement when the consumer (c) 102 is in a shopping mood, and therefore, more receptive to making a purchase or engaging in a transaction. Here, the announcement condition may be a real-time location of the consumer (c) 102 within a specified spatial zone (e.g., a specified shopping mall), for example. To illustrate, the host (h) 106 may receive a signal including data about the real-time location of the consumer (1) 102, such as a signal from a co-located cellular telephone of the consumer (1) 102, or a real-time authorization request for a transaction between the consumer (1) 102 and the merchant (1) 104. The host (h) 106 may utilize the data in the received signal to determine the real-time location of the consumer (1) 102, compare the determined real-time location of the consumer (1) 102 with a criterion of the announcement condition to find a match (e.g., the consumer (1) 102 is located in the specified shopping mall). If a match is found, the announcement is sent to the consumer (1) 102 (or other announcement recipients) within temporal proximity to finding the match (e.g., right after finding the match, within seconds or hours of finding the match). In this manner, the consumer (1) 102 may receive the announcement while the consumer (1) 102 is still in the shopping mood and the user's desired targeting goals are met.

Referring to Figures 3 and 4, flowcharts depict an exemplary method 300 this continued at reference numeral 400 in Figure 4. In method 300, an announcement distributor provides and/or auctions at least one announcement to at least one announcement recipient. At a step 302, an announcement condition for announcing data to the announcement recipient is specified. In one implementation, at least one of the users specifies the announcement condition to host (-h) 106. For example, the merchant (m) 104 may select the announcement condition from a menu of announcement conditions at an interactive website linked to the transaction handler (th) 206 via channel 118.

An announcement condition can be specified to include one or more criterion. The announcement condition can be the occurrence of a physical activity, the status of specific data, the existence of a particular state, a time period (e.g., during daylight hours), a location within a spatial zone (e.g., a consumer is situated within a specified shopping mall but is not situated within a movie theater that is in the shopping mall), etc. When the announcement condition is satisfied, delivery of the announcement to the announcement recipient(s) is triggered. For example, the criterion may include: the transaction handler (th) 206 receiving one of the transactions of a selected consumer (c) 102 from the acquirer (q) 204 of the merchant (m) 104; a

demographic of the consumer (c) 102; a category of the account of the consumer (c) 102 (e.g., gold card); a window of time in which the announcement is sent (e.g., sending the announcement: during hours of operation of a shop of the merchant (m) 104 or during the day, or during a lunch hour); a transaction history of one of the accounts of the consumer (c) 102, such as when a group of the transactions of the consumer (c) 102 show a tendency to purchase a particular type of resource; a tendency to purchase the resource of competitors of the merchant (m) 104; a seasonal trend in a purchasing behavior of the consumer (c) 102; a status of the PCD (e.g., the cellular telephone is "on") ; or a combination of the forgoing.

In some implementations, at least one of the criteria of the announcement condition may be a presence or an absence of the consumer (c) 102 within a geographically specific zone (e.g., a region) such that the presence of the consumer (c) 102 in that zone triggers the announcement and/or affects the content of the announcement. The zone may be, for example, an Internet zone, a virtual zone, a spatial zone, or a combination thereof.

In one implementation, the announcement condition is specified to be the presence of the consumer (c) 102 within an Internet zone, where a PCD identified with the consumer (c) 102 is detected as being in communication with a pre-selected group of network devices (e.g., Net (n) 108 through Net (n+3) 108) that are having logic addresses within a specified set of Uniform Resource Locators (URLs), Internet Protocol (IP) addresses, or domain names (e.g., ".com and .org" or "www.cnn.com and www.msnbc.com") with sub-domain names (e.g., www.cnn.com/health").

In another implementation, the announcement condition is specified to be the presence of the consumer (c) 102 within a virtual zone having virtual borders within a virtual environment. Such an environment is graphically depicted in a display rendered by a computer. The consumer (c) 102 may be a gamer that operates a graphical user interface so as to navigate a virtual character identifiable to consumer (c) 102 that is detected as entering or exiting the virtual zone.

In another implementation, the announcement condition is specified to be the detected presence of the consumer (c) 102 within a spatial zone having geographic borders, for instance, a specific radius of three kilometers defined about a specified center point located within a store of merchant (m) 104 (e.g., within three kilometers above a location within the store of the merchant (m) 104). However, the borders for the spatial zone need not have a defined and rigid geometric shape. In yet another implementation, the announcement condition is specified to be the detected absence of the consumer (c) 102 within a spatial zone having geographic borders. For instance, the condition may include the absence of the consumer (c) 102 within one or more specified restaurants. Therefore, if the consumer (c) 102 is detected to be in the spatial zone (i.e., the

consumer is detected as being situated within one of the specified restaurants), the condition is not satisfied and the announcement recipient (e.g., the consumer (c) 102) will not receive the announcement. For example, if the consumer (1) 102 is detected to be present within a restaurant, presumptively dining out, the consumer (1) 102 will not receive an announcement.

5 In yet a further implementation, the announcement condition is specified to be the detected presence of the consumer (c) 102 within a first spatial zone having geographic borders and the detected absence of the consumer (c) 102 within a second spatial zone. For example, the announcement condition can be specified to be the presence of the consumer (1) 102 near a specified street but not near a specified cross section of the street with another street (e.g.,

10 consumer (1) 102, "Sally", is near Michigan Street in Chicago, IL but is not detected as being at the cross section of Michigan and Wacker in Chicago, IL).

An algorithm can be specified so as to operate upon data such that, when the algorithm operates on the data, a determination is made as to whether the announcement condition has been satisfied. In one implementation, the transaction handler (th) 206 may operate the algorithm, by

15 uses of a computing system, so as to access data stored in the DB 110 or in data associated with transactions as they pass through the payment processing system 200. The operation of the algorithm upon these data can thereby determine if the announcement condition has been satisfied. For example, the announcement condition require that consumer (c) 102 be moving in a particular direction (e.g., movement towards or away from the location of store of the merchant

20 (m) 104). The algorithm may operate upon position data for the consumer (c) 102 over a period of time, where these data are derived the direction of movement of the consumer (c) 102 or where the direction of the consumer (c) 102 must match a required direction of movement and thereby satisfy an announcement condition.

The announcement recipient may be selected at the step 302. The announcement

25 recipient may be any individual or entity that can receive the announcement, such as any of the users of an announcement system. The selection of the announcement recipient may include providing a logical address, such as an e-mail address or telephone number, that can be used to electronically transmit the announcement to the announcement recipient. For example, the merchant (m) 104 may specify the announcement condition: "notify me at sale@merchant.com

30 when any [consumer (c) 102] in [the payment processing system 200] has made an online purchase of a tree from my competitor's retail nursery store." Alternatively, or in combination, the announcement distributor may use any electronic method of looking up an address for an identified announcement recipient. To illustrate, the consumer (1) 102 may specify to the transaction handler (th) 206 that the consumer (2) 102 is the announcement recipient. The

transaction handler (th) 206 may access the DB 110 to determine the address of the consumer (2) 102 that can be used to send the announcement to the consumer (2) 102.

The announcement recipient need not be the user specifying the announcement condition. Stated another way, the criterion of the announcement condition may be specified by one of the users of the announcement system that is different from the announcement recipient. For
5 example, the transaction handler (th) 206 specifying the announcement condition can also specify the consumer (1) 102 as the announcement recipient. To illustrate, the consumer (1) 102 may create a profile with the transaction handler (th) 206 that includes an account identifier of an Individual Retirement Account (IRA) of the consumer (1) 102. The transaction handler (th) 206
10 can specify: “if [the consumer (1) 102] profile has an IRA, then determined a time zone of [the consumer (1) 102] based on a data received from a co-located cellular telephone of [the consumer (1) 102] and send to the cellular telephone the announcement about the status of stock trade rates for stock in the IRA every Monday at 8:00 a.m. in the determined time zone.”

Similarly, other users of the announcement system may specify the consumer (1) 102 as
15 the announcement recipient for their respective announcements. For example, the issuer (i) 202 that has issued the account to the consumer (c) 102 may specify the consumer (c) 102 as the announcement recipient, such as “send the announcement to [the consumer (2) 102] after [the consumer (2) 102] has charged over \$300 US on the charge account that was issued to [the consumer (2) 102].” In yet another example, the merchant (m) 104 may have a personal shopper
20 that typically assists the consumer (3) 102 when the consumer (3) 102 shops at the store of the merchant (m) 104. The merchant (m) 104 may specify the announcement condition such that the consumer (3) 102 receives a message on their cellular telephone indicating whether or not the personal shopper is located at a store near the present location of their cellular telephone.

At a step 304, data usable to determine if the announcement condition has been satisfied
25 is received via at least one of the Net (n) 108. For example, the received data may be the transaction information received during the processing of the corresponding transaction in the payment processing system 200. Alternatively, or in combination, the received data may be the position data of the PCD received from the PCD or from a Bluetooth reader via the Net (n) 108 (i.e., satellite network or the Internet), for example.

30 The received data may be the transaction information. To illustrate, a targeting merchant (m) 104 may be interested in transactions of a targeted consumer (c) 102 (e.g., one of the consumers 102 that has a gold account). The transactions of the targeted consumer (c) 102 may be with a surrogate merchant (m) 104, such as a competitor of the targeting merchant (m) 104 or one of the merchants 104 that the targeting merchant (m) 104 is collaborating with to mutually

increase sales to the consumer (c) 102. Therefore, the targeting merchant (m) 104 may specify the announcement condition as the occurrence of the transaction between the targeted consumer (c) 102 and the surrogate merchant (m) 104 within the payment processing system 200. When the transaction handler (th) 206 receives an authorization request for a transaction between the surrogate merchant (m) 104 and the targeted consumer (c) 102, the transaction handler (th) 206 may process the transaction as usual, forwarding the authorization request to the corresponding issuer (i) 202 for authorization. The transaction handler (th) 206 may also use the transaction information in the received authorization request to determine if any of the announcement conditions in the announcement system 100 have been satisfied at a step 306. Here, the transaction handler (th) 206 may determine that the announcement condition of the targeting merchant (m) 104 is satisfied, or has occurred, because the consumer (c) 102 has conducted a transaction with the surrogate merchant (m) 104.

If the announcement condition is the presence of the consumer (c) 102 within a geographic zone, the received data may be data usable to determine the location of the consumer (c) 102. For example, the received data can be the transaction information that is received approximately in real-time, or can be data that is received from a co-located PCD of the consumer (c) 102. The transaction information received approximately in real-time may be an authorization request that is transmitted to the transaction handler (th) 206. The authorization request may contain a code from which the location of the merchant (m) 104 can be determined, such as a Merchant Category Code (MCC) or another merchant identifier of the corresponding merchant (m) 104. In one implementation, the transaction handler (th) 206 may presume that the consumer (c) 102 is still in the same location as the POI of the merchant (m) 104 as the authorization of the transaction is occurring because the transaction information is being received approximately in real-time. As such, the location of the consumer (c) 102 can be reliably determined from the code that was received code with the authorization request.

Alternatively, or in combination with the above implementation, the received data may include data from a PCD that is co-located with consumer (c) 102. The PCD will be deemed to be co-located with the consumer (c) 102 when the location of the consumer (c) 102 can be reasonably determined from data received from the PCD. For example, the PCD of the consumer (c) 102 may be a cellular telephone with location detecting capabilities as are known in the art (e.g., cellular telephony, triangulation, global positioning system (GPS), the PCD's detection of wireless networks the geographic location of which can be determined from a preexisting database of wireless network locations, etc.) To illustrate, the consumer (c) 102 may carry a cellular telephone having a GPS receive, or a functional equivalent thereof, while

shopping at a shopping mall. As such, the cellular telephone will receive location coordinates from which the location of the PCD can be determined. The determined position, or coordinates, may in turn, be transmitted to the host (h) 106 via the Net (n) 108. The determined position can be expressed in a variety of forms including: a street address; a latitude, a longitude or an altitude; World Geodetic System coordinates; data usable to determine a direction, speed, and/or acceleration of the PCD's movement; combinations of the foregoing, or a time rate of change of the foregoing, etc.

The received data may contain information from more than one of the PCDs. For example, a first consumer (1) 102 may have a first PCD that is wireless Radio Frequency Identifier (RFID) enabled payment card that does not have position detecting capabilities, while a second consumer (2) 102 may have a second PCD that is an RFID receiver and a location detector. The first and second PCDs may come in close proximity to each other. The first PCD may transmit a radio frequency signal containing a first consumer identifier of the first consumer (1) 102 to the second PCD. The second PCD may, in turn, transmits both its real-time location and the first consumer identifier to the host (h) 106 via channel 112 that connects the second consumer (2) 102 to the Net (n) 108, and channel 118.

At a step 306, the data received in the step 304 is used to determine whether the announcement condition is satisfied. The data received in the step 306 and/or the data stored in the DB 110, may be accessed and compared to each of the criteria of the announcement condition to determine if there is a corresponding match. If the match exists, then the announcement condition is deemed to be satisfied. Logic rules may dictate which, or how many, of the criteria should be matched in order to determine the announcement condition as satisfied. For example, the logic rules may indicate that the data received in the step 306 and/or the data stored in the DB 110 should either match both a first criterion and a second criterion or match a third criterion to determine the announcement condition as satisfied.

In the above example, the targeting merchant (m) 104 may have specified the announcement condition as: "when one of [the consumers (1-c) 102], having a gold credit account, shops with my direct or substitute competitor, send [the consumer (c) 102] the announcement including my offer." After an authorization request is sent to the transaction handler (th) 206 from the POI of the competitor merchant (m) 104, the transaction handler (th) 206 may compare the data in the authorization request with the data stored in the DB 110 to determine if the announcement condition is satisfied. For example, the transaction handler (th) 206 may determine if the authorization request is for a transaction with the direct competitor of the targeting merchant (m) 104 by comparing a merchant identifier in the authorization request

with the merchant identifier of the targeting merchant (m) 104 stored in the DB 110. If the merchant identifiers are each associated with the same merchant category, then the authorization request is for a transaction with a direct competitor of the targeting merchant (m) 104. Similarly, the transaction handler (th) 206 may determine if the authorization request is for a transaction with the substitute competitor of the targeting merchant (m) 104 by determining that the merchant categories of each of the targeting merchant (m) 104 and the surrogate merchant (m) 104 are associated with one another. For example, the merchant category of the targeting merchant (m) 104 may be for a “pastry shop” while the merchant category of the surrogate merchant (m) 104 may be for an “ice cream shop.” The “pastry shop” merchant category and the “ice cream shop” merchant category may be associated with one another because each corresponding merchant (m) 104 may be considered a retailer of sweet food items that can serve as deserts. Therefore, because the merchant categories are associated with one another, such as by corresponding identifiers that are logically associated with their merchant categories, they can be considered as substitute competitors.

Other criterion of the announcement condition of the targeting merchant (m) 104 may also be matched. For example, the transaction handler (th) 206 may determine that the consumer (c) 102 has the gold credit account by comparing a received BIN in the authorization request with the BINs of gold credit accounts stored in the DB 110. In another example, the announcement condition may include a specified name of the targeted consumer (1) 102 (at the step 302). The transaction handler (th) 206 may use an account identifier received in the authorization request to access the DB 110 and retrieve a name of the consumer (c) 102 associated with the account identifier. If the name retrieved from the DB 110 matches the specified name of the targeted consumer (1) 102, then the corresponding criterion is considered satisfied.

Data received in the step 304 can be used to derive other data that is then compared with the criterion. For example, the issuer (i) 202 may have specified the announcement condition “send the announcement to me when [the consumer (c) 102] that is located in the mall is within \$100 US of the credit limit of the account that was issued to [the consumer (c) 102].” Thereafter, the transaction handler (th) 206 receives an authorization request for a transaction of the consumer (c) 102 that is being conducted upon that account for \$50 US. The transaction handler (th) 206 may then calculate the total charge on the account by combining the newly charged \$50 US with the transaction history of the account of the consumer (c) 102 that is stored in the DB 110. The transaction handler (th) 206 may then compare the calculated total charge with the above \$100 US criterion to determine if the announcement condition is satisfied.

In another example, the PCD of the consumer (c) 102 may execute an algorithm that determines if a criterion of a corresponding announcement condition is met, and then transmit its determination to the host (h) 106. For example, the PCD of the consumer (1) 102 may have an applet that not only receives and transmits location data but also determines whether the PCD is in a spatial zone matching a criterion of the announcement condition. To illustrate, the consumer
5 (1) 102 may create a profile on an interactive website of the host (h) 106 for use in the announcement system 100. The consumer (1) 102 may indicate an interest in receiving announcements when the consumer (1) 102 is located the spatial zone. The consumer (1) 102 may download information about the spatial zone unto the PCD of the consumer (1) 102. When
10 the location of the PCD is determined by the PCD, the PCD may compare its determined location with the downloaded information about the spatial zone to see if there is a match. The PCD may transmit the matching result to the host (h) 106, thereby indicating that the consumer (1) 102 is in the spatial zone. The host (h) 106 may, in turn, determine if an announcement condition for any user in the announcement system 100 has been satisfied by the presence of the
15 consumer (1) 102 in the spatial zone. If an announcement condition is satisfied, then the host (h) 106 may transmit to the PCD of the consumer (1) 102 the announcement that corresponds to the announcement while the PCD is still within that spatial zone.

Alternatively, or in combination, the PCD may determine if the announcement condition is satisfied. In one implementation, the PCD may download an applet usable to determine if at
20 least one announcement condition is satisfied. The PCD can determine its location and, via execution of the applet, compare its location with at least one location criterion (e.g., a specified spatial zone) of a corresponding downloaded announcement condition to see if there is a match. The PCD may form a transmission addressed to the host (h) 106 indicating an outcome of this comparison. For example, if the corresponding criteria of at least one of the announcement
25 conditions is satisfied, the PCD can form a transmission informing the host (h) 106 of those announcement conditions that were satisfied. The host (h) 106 may, in turn, form a transmission that includes an announcement corresponding to the satisfied announcement condition(s) for delivery thereof to corresponding announcement recipient(s).

At a step 308, a determination is optionally made as to whether the announcement
30 distributor has consented to distribute the at least one announcement to the announcement recipient. For example, while a first user may affirmatively consent to distribution of data about the first user within the announcement system 100, a second user may request that the data about the second user not be distributed to any other user but the second user. To illustrate, the transaction handler (th) 206 may determine access rights by, for example, determining if the

consumer (c) 102 can have access to the transaction information of the merchant (m) 104 based on contractual obligations of the transaction handler (th) 206 to the merchant (m) 104. In another example, the announcement distributor may be restrained from lawfully sending announcement due to privacy laws that may apply to the distribution of the data in the announcement. In such cases, the announcement distributor will be deemed not to have
5 consented to distribute the announcement.

If at least one of the announcements is to be sent to the announcement recipient after an auction, the step 310 proceeds to a step 402 in the Figure 4, otherwise the step 310 proceeds to a step 312.

10 At the step 312, the delivery of the announcement to the announcement recipient is facilitated if the announcement condition is satisfied in the step 306. In the above example of the targeting merchant (m) 104 and the surrogate merchant (m) 104, the announcement may be sent to the targeting merchant (m) 104, wherein the announcement includes data about the transaction of the surrogate merchant (m) 104 with the consumer (c) 102. For example, the targeting
15 merchant (m) 104 may receive a transmission indicating that the consumer (c) 102, having the gold credit account, has just purchased a Rolex® watch from the surrogate merchant (m) 104. Having received the announcement, the targeting merchant (m) 104 may send a personalized catalog to the consumer (c) 102 via e-mail. The catalog, for instance, could be showcasing accessories for the Rolex® watch that are sold by the targeting merchant (m) 104.

20 As stated previously, the announcement may be transmitted to any of the suitable communication devices of the announcement recipient via the Net (n) 108. For example, the announcement may be sent via channel 114 to the POI of the merchant (m) 104 for delivery to the consumer (c) 102, such as when the announcement is printed on the back of a paper receipt memorializing the transaction with the consumer (c) 102. Alternatively, or in combination, the
25 announcement may be first received at the POI of the merchant (m) 104, and then be sent to the PCD of the consumer (c) 102 via an RFID transmission across channel 116. In another example, the announcement may be sent to the PCD (e.g., the cellular telephone) of the consumer (c) 102 via channel 112, such as when the consumer (c) 102 receives an e-mail at an e-mail enabled cellular telephone, where the e-mail contains an offer of the merchant (m) 104. In another
30 example, the announcement may be sent to the issuer (i) 202 via channel 208, such as when the issuer (i) 202 receives the announcement: at a computer of the issuer (i) 202 informing the issuer (i) 202 that the consumer (c) 102 typically uses the account issued by the issuer (i) 202 to purchase children's shoes in the month of September and it is currently the month of August; or as an automated voice message sent to a telephone of the issuer (i) 202 and informing the issuer

(i) 202 that a small-business account of the consumer (c) 102 is nearing its credit limit. In yet another example, the acquirer (q) 204 may receive an announcement that was sent over channels 210, 114, where the announcement informs the acquirer (q) 204 that a payment toward a purchase order of the merchant (m) 104, long overdue, has finally been cleared and settled.

5 In some implementations, the announcement may facilitate communication about the resources of the merchant (m) 104 to the consumer (c) 102. For example, the merchant (1) 104 may receive the announcement including the name of the consumer (1) 102 that was detected as just having walked into one of the stores of the merchant (1) 104. The merchant (1) 104 may search a local merchant database to determine if the consumer (1) 102 has a personal shopper
10 that has assisted the consumer (1) 102 in the past. The merchant (1) 104 may have an automated voice message sent to the personal shopper. The automated voice message may request that the personal shopper greet the consumer (1) 102 as well as market the resources of the merchant (m) 104 to the consumer (1) 102 as also as the consumer (1) 102 is still in the one of the stores of the merchant (1) 104.

15 After the announcement is received, other transmissions can be sent through the announcement system 100. For example, the announcement recipient may send a confirmation that the announcement was received or form a transmission to the host (h) 106 for delivery to another announcement recipient. To illustrate, the announcement may be received as a coupon that can be graphically rendered by a browser executing on a PCD of the consumer (3) 102,
20 where the rendered coupon has hyperlinked buttons for accepting or declining an offer of the merchant (1) 104. The consumer (3) 102 may electronically accept the offer of the merchant (1) 104 by selecting an “accept” button rendered on by the browser of the PCD. The acceptance may be transmitted to the Net (3) 108, and then sent to the merchant (1) 104 via channel 114. Alternatively, or in combination, the acceptance may be transmitted via the Net (1) 108 to the
25 acquirer (q) 204 via channel 210, and then sent to the merchant (1) 104 via channel 210 to Net (2) 108, and then sent to the merchant (1) 104 via channel 114.

 Alternatively, or in combination, if at least one announcement distribution is to be auctioned to the user(s) of the announcement system, then the method 300 moves from the step 310 to a step 402 of the Figure 4. The announcement system 100 may be used to auction an
30 announcement opportunity. The successful bidder(s) of the action will thereby by the announcement opportunity to have one or more announcements delivered to one or more announcement recipients.

 At a step 404, at least one auction participant (e.g., one of the users) is notified that the announcement opportunity is up for auction. In one implementation, the transaction handler (th)

206 may transmit an electronic message via the Net (n) 108 to the users that have indicated an interest in taking part in the auction within the announcement system 100. For example, the electronic message may be an alert sent to a computer of each auction participant, such as a pop up window enabled by an Internet browser executing on the computer of the auction participant.

5 The alert may have a hyperlink to the website at which the auction participant can submit bids to 'win' the announcement opportunity. Alternatively, the electronic message may be an e-mail message or an electronic voice message sent to the auction participant. Other forms of electronic messages, as are known by those of ordinary skill in the relevant art, are also contemplated.

The auction may initiate after an auction initiating condition has been satisfied. For example, the auction initiating condition may be a required number of auction participants for a particular auction. Other auction initiating conditions may include: a time of day, a date, a number of announcement opportunities that can be bundled and auctioned together, receipt of an auctioning fee from the auction participants, the satisfaction of a particular announcement condition (e.g., presence of the consumer (c) 102 in the zone), or a combination of the foregoing.

15 The auction for the announcement opportunity may be initiated before, during, or after the announcement condition is satisfied because the auction initiating condition and the announcement condition need not be the same. For example, the auction initiating condition may be a particular time of a particular day (e.g., 9:00 a.m. on July 10, 2008) that the auction is to begin, while the announcement condition may be the presence of the consumer (c) 102 in the spatial zone after the particular time of the particular day. Consequently, in this example, the auction participants may submit bids on July 10, 2008 and the winning bidder(s) of the auction will receive the opportunity to send announcement(s) to the consumer (c) 102 when the consumer (c) 102 enters the spatial zone, for instance, on the later date of October 31, 2008.

25 Alternatively, the announcement condition and the auction initiating condition may be the same. For example, if the auction initiating condition and the announcement condition is the presence of the consumer (c) 102 in the spatial zone, the auction participants may receive a notice that the auction has commenced when the consumer (c) 102 enters the spatial zone. Thereafter, the winners of the auction can be selected and the winners of the auction can have their respective announcements delivered while the consumer (c) 102 is still present in the spatial zone.

30 The auction may be electronically conducted. For example, the auction participants may access an auction website at which the auction participant or agent thereof may submit a corresponding bid to an auctioneer for the announcement opportunity to have their announcement delivered to the announcement recipient. In one implementation, the auction

participant may log onto a secure website and submit bids to the host (h) 106 via in an interactive, live electronic auction. In another implementation, the auction participant may transmit an e-mail containing a silent bid to the transaction handler (th) 206 that is the auctioneer of the announcement opportunity in an electronic auction that is not live.

5 The auction may be any of a variety of auction types. For example, as is known by those of ordinary skill in the relevant art, the auction can be:

- an English auction, wherein bidders bid openly toward an ascending price;
- a Dutch auction, wherein bidders bid openly toward a descending price;
- a buyout auction wherein any bidder can immediately win the auction by bidding a
10 preset price;
- a sealed-bid first-price auction, wherein bidders submit sealed bids that are not known by other bidders and the winner is the highest bidder;
- a sealed-bid second-price auction, wherein bidders submit sealed bids and the winner
15 pays the second highest bid that was submitted rather than the highest bid that was submitted;
- a silent auction, wherein bidders submit silent bids and the highest bidder, who is the winner of the auction, pays the price that they submitted;
- an all-pay auction wherein bidders pay their bids regardless of whether the bidder has the winning bid;
- a combinatorial auction, wherein bidders bid on packages of bidding items in an “all-
20 or-nothing” fashion;
- a reserve auction, wherein the auctioned item will not be sold if the final bid is below a preset price;
- a no-reserve auction, wherein the auctioned item will be sold regardless of price;
- a reverse auction wherein multiple announcement distributors compete by offering
25 progressively lower prices for at least one announcement;
- a round robin auction wherein bidders submit bids prior to a deadline, receive notice of the highest bid, and are given a chance to outbid the highest bid;
- a Walrasian auction, wherein the auctioneer takes bids from both buyers (*e.g.*, the
30 consumers (1-c) 102) and sellers (*e.g.*, the merchants (1-m) 104) and concludes the auction when the supply and demand match;
- a supply auction, wherein multiple seller sell bid items that a buyer requests;
- a demand auction, wherein buyers bid for the bid item being sold;

- a double auction, wherein multiple buyers bid for multiple bid items of multiple sellers;
- an open auction, wherein bidders are aware of each other's bids and can each bid multiple times;
- 5 • a closed auction, wherein bidders submit sealed bids;
- a raffle, wherein bidders pay a set price for an opportunity to randomly win the auction; or
- a combination of the forgoing.

At a step 406, at least one bid from at least one auction participant is received. For
10 example, the acquirer (q) 204 may transmit an SMS text to the transaction handler (th) 206 via
the Net (n) 108 including a monetary bid to receive an announcement containing data about the
transaction history of the consumer (c) 102. In another example, the consumer (c) 102 may log
onto an auction website using a desktop computer or the PCD of the consumer (c) 102 to bid on
an announcement containing data about resources that had been previously sold at a store of the
15 merchant (m) 104. The bid may offer currency, such as money or points, in exchange for the
announcement opportunity. In the example above, the consumer (c) 102 may bid 1000 points for
the announcement opportunity to receive the announcement containing data about the resources
of the merchant (m) 104.

The users interested in participating in the auction (e.g., "auction participants",
20 "bidders", "buyers", or "sellers") are each given a chance to place a bid for an announcement
opportunity. In this case, the announcement opportunity being auction is the right to receive an
announcement that consumers having gold cards are in a particular shopping. In this case,
merchant (1) 104 and merchant (2) 104 may each be interested in receiving the announcement
indicating when the consumers 102, having corresponding gold cards, have entered a mall that
25 includes stores of merchant (1) 104 and merchant (2) 104. An auctioneer (e.g., the host (h) 106
or agent thereof) may auction the announcement opportunity to merchant (1) 104 and merchant
(2) 104. If, for example, merchant (1) 104 wins the auction by having the highest monetary bid
for the announcement opportunity, the auctioneer may send the announcement to merchant (1)
104 and but not to merchant (2) 104. Alternatively, the auction may have multiple winners such
30 that each of merchant (1) 104 and merchant (2) 104 receive the announcement of the gold card
shoppers being in the shopping mall.

The bidder may indicate who the bidder designates to be the announcement recipient of
the announcement being auctioned. For example, the merchant (1) 104 may be interested in

participating in an auction to have an offer of the merchant (1) 104 to be delivered to the consumer (c) 102 that is present in the spatial zone. If the merchant (1) 104 has the winning bid in the auction, the consumer (c) 102 will receive the offer of the merchant (1) 104 after the consumer (c) 102 enters the spatial zone.

5 At a step 408, a winning bid is selected based on at least one bid criterion. The bid criterion may be, for example: a required format for the bid (e.g., having a name of the bidder, a required deposit, receiving the bid within a window of time); a highest monetary offer among the corresponding monetary offers; a lowest monetary offer among the corresponding monetary offers; or a combination thereof. Different types of the auctions may have different winning bid
10 criteria. To illustrate, in the reserve auction, one of the bid criterion may be that a currency amount of the winning bid must be higher than a preset price.

 At a step 410, the auction participants, such as a subset of the users that submitted a corresponding bid, are notified about the results of the auction, such as being notified about a selection of a winning bid. For example, the transaction handler (th) 206 may post at an auction
15 website that the auction has ended, wherein the auction participants can access the auction website and receive the posting. Alternatively, the host (h) 106 may send a notification to the winning bidders that each have won the auction to receive the announcement, which will be delivered after the announcement condition has been satisfied.

 At a step 412, if the announcement condition is satisfied, the delivery of the
20 announcement to the announcement recipient is facilitated. For example, after the announcement condition is satisfied, the host (h) 106 may transmit an e-mail containing the announcement to the designated announcement recipient.

 The steps in Figures 3-4 may be conducted in any order and/or may be repeated several times. For example, the bid for the announcement opportunity to have the announcement
25 delivered may be received (the step 406) prior to the step 304, wherein the data usable to determine that the announcement condition is satisfied is received. Alternatively, or in combination, the step 304 of receiving the data usable to determine that the condition is satisfied may be repeated several times prior to determining that the announcement condition is satisfied (the step 306).

30 The users of the announcement system 100 may receive reports. The reports may include, for example, a frequency of use of the announcement system 100, a number of times the announcement was sent to the announcement recipient, the number of times the announcement recipient responded to the announcement by sending a subsequent message through the

announcement system 100, the bids submitted for the corresponding announcement opportunity, or data stored in the DB 110.

Exemplary Implementations

For exemplary purposes only, a number of implementations are described below. The announcement system 100 may be used to: announce the transaction history of the consumer (c) 102 to the users; announce or auction an announcement about the presence of the consumer (c) 102 in a spatial zone; announce the virtual presence of the consumer (c) 102 online and browsing one or more Internet websites in a defined group thereof; announce, to the merchant (m) 104, the actions of the consumer (c) 102 relative to a second, surrogate, merchant (m) 104; announce data about the past transactions of the merchant (m) 104 to the consumer (c) 102; or announce, to the consumer (c) 102, data about the transactions of other of the consumers 102 in a consumer group, for example.

Transaction History Announcement and Auction Example

In this example, users of announcement system 100 receive an announcement containing data about a transaction history of one of the accounts of consumer (1) 102 and can bid for an announcement opportunity to receive a second announcement containing the spend on a plurality of the accounts. For example, the consumer (1) 102 may have three (3) accounts within the payment processing system 200 - a Wells Fargo® charge account, an M&I® debit account, and a Walgreens® gift account, each having a respective issuer (i) 202. Each of the issuers (i+1, i+2, and i+3) 202 may have specified to the transaction handler (th) 206 the announcement condition (the step 302) indicating an interest in receiving an announcement containing information about the spend on the three (3) accounts over a duration of time, such a month. The transaction handler (th) 206 may receive the transaction information for a plurality of transactions between the consumer (c) 102 and a plurality of merchants 104 upon the three (3) accounts (the step 306). At the end of a month, the transaction handler (th) 206 may calculate a spend of the consumer (1) 102 on each of the three accounts for the month (the step 304). The transaction handler (th) 206 may announce the spend on one of the accounts to the corresponding issuer (i) 202 (the step 312) while auctioning off, to each of the three issuers (i+1, i+2, and i+3) 202, the announcement opportunity to receive the information about the spend on all three (3) accounts (the step 410). Each of the three issuers (i+1, i+2, and i+3) 202 may electronically submit monetary bids for the announcement opportunity (the step 406) to the transaction handler (th) 206 via an interactive website where an open auction is conducted for the announcement opportunity to receive the full spend report. The transaction handler (th) 206 may select two winning bids having the top two monetary values (the step 408). The transaction handler (th)

206 may transmit a message via the Net (n) 108 to the winning bidders indicating that each has won the auction (the step 410). For example, the transaction handler (th) 206 may transmit the announcement including the information about the spend on the three accounts to each of the winning bidders by sending e-mails to the each of the winning bidders (the step 412). Each issuer (i) 202 having a respective winning bid may, in turn, take action on the received announcement, such as providing new account incentives to the consumer (1) 102 in order to shift more of the spend on each of the three accounts to the account that the respective issuer (i) 202 had previously issued to the consumer (1) 102.

Spatial Zone Triggered Announcement & Auction Example

10 In this example, several users of the announcement system specify corresponding announcement conditions, wherein delivery of a corresponding announcement is triggered by the presence of the consumer (c) 102 in a particular spatial zone. For example, four of the users may enroll in an announcement program of the transaction handler (th) 206. Each of the users may pay a subscription price to the transaction handler (th) 206 to be able to participate as one of the users in the announcement system 100. The users may include: a targeted consumer (1) 102 (‘‘Sam’’), a Starbucks® franchisor of Starbucks® coffee shops, a Wells Fargo® issued first account of Sam, and an M&I® issued second account of Sam, wherein each of the first and second accounts are associated with a respective RFID enabled PCD. One of the Starbucks® stores may install an RFID reader at its entrance that detects RFID enabled PCDs of consumers 20 102 as they enter the store.

Each of the users in the announcement system 100 may specify respective announcement conditions (the step 302). For example, the Starbucks® franchisor may create a profile at a website of the host (h) 106. The profile may include a tailored greeting message, updated intermittently, that the Starbucks® franchisor would like to be delivered to any consumer 102 in the announcement system 100 that (1) is moving in a target direction (e.g., toward one of the Starbucks® stores) and (2) has previously made a purchase from the Starbucks® store located in the target direction. The tailored greeting message may be, for example, ‘‘Hello [name of the any consumer (c) 102], should we prepare your usual [name the resource typically purchased at the Starbucks® store] before you arrive?’’ Similarly, the Wells Fargo® issuer and the M&I® issuer may each use the website to specify a respective announcement condition, such as, ‘‘send, to any consumer (c) 102 that has entered a spatial zone, an announcement including an offer of reward points if the corresponding consumer (c) 102 conducts a transaction on the account that we issued to the consumer (c) 102.’’ The consumer (1) 102, ‘‘Sam’’, may also specify an announcement condition, wherein Sam specifies that Sam does

not want to receive any announcements from the users of the announcement system 100 if the announcement is making an offer to Sam that is below a threshold of three hundred (300) loyalty points.

5 Sam may use a monthly train pass to enter a transit system to travel to his place of employment, where the place of employment and a Starbucks® store are each located within a specified spatial zone. The transaction handler (th) 206 may receive information from the transit system that can be used by the transaction handler (th) 206 to deduce that Sam has entered the transit system (the step 304). The transaction handler (th) 206 can also access the data stored in the DB 110 (*e.g.*, the transaction history of the accounts issued to Sam) to determine that Sam
10 typically purchases a latte hot drink from the Starbucks® store approximately thirty minutes after Sam enters the transit system. Consequently, the transaction handler (th) 206 can determine that the announcement condition of the Starbucks franchisor is satisfied because (1) Sam has moved in the direction of Starbucks® store (the step 306) and (2) Sam has previously purchased a latte at the Starbucks® store. The transaction handler (th) 206, upon satisfaction of this
15 announcement condition, may send this tailored greeting message: "Hello Sam, should we prepare your usual latte before you arrive?", which message will be delivered to Sam in a pop up window rendered on a co-located cellular telephone known to be carried by Sam (the step 312). Sam may respond by selecting "yes" on the pop up window, for subsequent real time transmission from Sam's cellular telephone. The Starbucks® store can receive notice of Sam's
20 interactively input choice by conventional means, such as by its receipt of an e-mail at an e-mail address associated with the Starbucks® store as was sent via the Net (n) 108. Moreover, the transaction handler (th) 206 may make the transaction for the latte payable upon one of Sam's accounts (*e.g.*, either his Wells Fargo® account or his M&I® account). Therefore, Sam can simply enter the Starbucks® store, pick up and begin to enjoy his already-prepared and waiting
25 latte, thereby avoiding waiting in line to order and/or pay.

Once Sam enters the Starbucks® store, its RFID reader at its entrance can read the account identifier of each of his first and the second accounts as are detected by Sam's respective co-located PCDs. This RFID reader may form a transmission for delivery to the transaction handler (th) 206 via the Net (n) 108. The transmission may include the account identifiers read
30 by the RFID reader and location data usable to determine the location of the RFID reader (the step 304). The transaction handler (th) 206 may compare the account identifiers received in the transmission with account identifiers stored in the DB 110 to match the account identifiers with Sam's' first and second accounts which have already been associated with the announcement program. Moreover, the transaction handler (th) 206 may use the location data to determine the

location the RFID reader, and compare the determined location with the spatial zone to find that Sam's location is the same as the location of the RFID reader. In this manner, the transaction handler (th) 206 can determine that the announcement condition of each of the Wells Fargo® issuer and the M&I® issuer are satisfied (at the step 306).

5 Under the announcement program, the announcement opportunity to communicate with Sam may be auctioned to the issuers 202 in the announcement system 100. Each of the Wells Fargo® issuer and the M&I® issuer may receive the notification that the auction for the announcement opportunity to deliver an offer of reward points has begun (the step 404). Each of the Wells Fargo® issuer and the M&I® issuer may submit respective monetary bids to the
10 transaction handler (th) 206. Here, the Wells Fargo® issuer may bid 500 loyalty points for a transaction on Sam's first account and the M&I® issuer may bid 200 loyalty points for a transaction on Sam's second account (the step 406). The transaction handler (th) 206 may use the bid criterion to determine the winner of the auction (the step 408). For example, the transaction handler (th) 206 may check both the value of the respective bids and an
15 announcement condition previously specified by Sam to determine the winner of the auction. Here, Sam had the announcement condition that announcements offering below 300 loyalty point should not be sent to Sam. Given the bid amount and the announcement condition of Sam, in this example, the Wells Fargo® issuer would be deemed to be the winner of the auction. Sam may receive the announcement on his PCD including the offer of loyalty points of the Wells
20 Fargo® issuer. The announcement, for instance, may be personalized based on the transaction information of Sam, such as: "if you purchase your usual latte with your Wells Fargo® account, Wells Fargo will give you 500 loyalty points toward your loyalty program" (the step 412). Sam may, but need not, confirm that the transaction should be conducted upon the Wells Fargo® account, such as by interactive use of a User Interface (UI) on Sam's PCD.

25 Any of the above three users may receive a report of announcements sent through the announcement system 100 dealing with the announcement program. For example, the M&I® issuer may be notified about why it did not win the auction, the Wells Fargo® issuer may receive a report on how many of the announcements were sent to consumers 102 that met the announcement condition of the Wells Fargo® issuer; the Starbucks® franchisor may receive a
30 report on how sales have increased or decreased after the tailored greeting messages were sent as determined from the transaction information of the Starbucks® store stored in the DB 110 for the consumers 102 that received the announcements including the corresponding greeting messages; or Sam may receive a report on how many of the announcements were blocked given his announcement condition, for example.

Internet Zone Announcement

Here, the announcement recipient receives the announcement that is triggered by the presence of the consumer (c) 102 in an Internet Zone. For example, the merchant (m) 104, a manufacturer of power tools, may access an interactive website of the host (h) 106 to specify the announcement condition “send me an email when any [consumer 102] between the ages of 30-60
5 years (the targeted consumer (c) 102) conducts an on-line purchase of the resources of a home improvement retailer” (the step 302). The transaction handler (th) 206 may receive an authorization request for an on-line transaction via the Net (n) 108 (the step 304), wherein the authorization request includes an account identifier and a code indicating that it is an on-line
10 transaction. The transaction handler (th) 206 may forward the authorization request to the corresponding issuer (i) 202 of the account identified in the authorization request. The transaction handler (th) 206 may also use the transaction information in the authorization request to determine whether the announcement condition has been satisfied (the step 306). The transaction handler (th) 206 may determine that the announcement condition is satisfied by: (1)
15 comparing the merchant identifier of the merchant (m) 104 that was received in the authorization request with the merchant identifier of “home improvement retailers;” (2) using the received code to determine that the transaction was conducted on-line; (3) using the received account identifier to retrieve from the DB 110 the age of the consumer (c) 102 engaged in the on-line transaction; and (4) comparing the retrieved age with the age range 30-40 criterion to find a
20 match. If a match exists, the transaction handler (th) 206 may send an e-mail about the on-line transaction to the manufacturer of the power tools (the step 312).

Targeting Merchant (m) 104 Announcement Example

In this example, consumer (c) 102 receives an announcement that is triggered based on the actions of the consumer (c) 102 with a surrogate merchant (m) 104. The announcement may
25 contain information about a targeting merchant (m) 104 that is different from the surrogate merchant (m) 104. The surrogate merchant (m) 104 can be, for example: a competitor of the targeting merchant (m) 104; one of the merchants 104 that is in the zone of interest to the targeting merchant (m) 104; one of the merchants 104 that has a contractual agreement to help market the resources of the targeting merchant (m) 104; one of the merchants 104 whose
30 transactions tend to occur within a temporal proximity of the transactions of the targeting merchant (m) 104; or one of the merchants 104 whose resources are utilized within a temporal proximity of the transactions of the targeting merchant (m) 104. Temporal proximity can be a time span from instantly, immediately, or in real time to a time span that is less than seven (7) days, for example.

In one implementation, the announcement condition may be based on occurrence of the transaction between the consumer (c) 102 and the surrogate merchant (m) 104. As stated previously, the targeting merchant (m) 104 may specify the announcement condition (the step 302) as a purchase by the consumer (c) 102 from the surrogate merchant (m) 104. The targeting merchant (m) 104 may select the surrogate merchant (m) 104 by name (e.g., “a Wal-Mart® store located on 5th Ave”), a category (“clothing retailer”), or location (e.g., “the Mills Mall”), for example. The announcement condition can further delineate: the type of the consumers 102 that are targeted (e.g., “Sally Smith,” “those consumers 102 that frequently shop with me,” or “gold card members”) or other parameters such as the purchase amount (e.g., purchases that are over \$100 US). The targeting merchant (m) 104 may also specify the announcement recipient to be the consumer (c) 102 that has engaged in the transaction with the surrogate merchant (m) 104 and/or the targeting merchant (m) 104. An algorithmic rule can be created based on the announcement condition of the targeting merchant (m) 104.

The host (h) 106 may determine if the announcement condition is satisfied by use of hardware executing an algorithm or software that determines if a transaction has occurred with the surrogate merchant (m) 104. For example, the transaction handler (th) 206 may determine if the announcement condition is satisfied by using an algorithm to distinguish the transaction of the surrogate merchant (m) 104 from among the plurality of received transactions and to analyze the corresponding received transaction information, such as by comparing the corresponding received transaction information with the data stored in the DB 110. For example, the transaction handler (th) 206 may execute the algorithm that finds matches between the merchant identifier of the merchant (m) 104 engaged in the distinguished transaction and the merchant identifier of the surrogate merchant (m) 104 selected by the targeting merchant (m) 104.

As stated previously, the match may be of respective merchant categories derived from the corresponding merchant identifiers. For example, the transaction handler (th) 206 may use the merchant identifier of the merchant (m) 104 engaged in the corresponding transaction to determine a category of the respective merchant (m) 104 (e.g., clothing retailer). The determined category can be compared with the category of the surrogate merchant (m) 104 selected by the targeting merchant (m) 104 (e.g., women’s clothing retailer) to find a match. The matching does not have to be exact. Rather, the algorithm may have matching rules that dictate the degree to which comparisons are deemed to be a match. Thereafter, if a match is deemed to exist, the announcement condition is considered satisfied and the announcement is sent to the announcement recipient.

To illustrate, the targeting merchant (m) 104 may be a Target® store and the surrogate merchant (m) 104 may be a Wal-Mart® store, a competitor of the Target® store. When the consumer (1) 102, Sally Smith, makes a purchase at the Wal-Mart® store, the transaction handler (th) 206 receives the transaction information, routes the purchase to the corresponding issuer (i) 202 of the account of Sally Smith, uses the merchant identifier in the transaction to match the Wal-Mart® store with the surrogate merchant (m) 104 in the announcement program, and sends the announcement to the Target® store, such as, “Sally Smith just bought a pair of scissors at the Wal-Mart® store.” Thereafter, the consumer (c) 102, Sally Smith, may receive this text message on her cellular telephone: “scissors are on sale at Target for \$20 US.”

As stated previously, the surrogate merchant (m) 104 may be one of the merchants 104 whose transactions occur within a temporal proximity with those of the targeting merchant (m) 104. The transaction information for the plurality of transactions between the merchants 104 and the consumers 102 may indicate that the consumers 102 that shop with the surrogate merchant (m) 104 also tend to shop with the targeting merchant (m) 104 within a window of time from the purchase at the surrogate merchant (m) 104. For example, those consumers 102 that engage in the transactions upon corresponding accounts with a Neiman Marcus® store in a mall also tend to purchase coffee about an hour later from the Starbucks® store in the mall using the same respective account. Stated otherwise, the consumer may have made a purchase in the past from a surrogate merchant and, within a window of time, made another purchase from a targeting merchant. As such, the targeting merchant will want to send its announcement to the consumer within the same window of time (*e.g.*, between the minimum and maximum windows of time) after the consumer makes a subsequent purchase from the surrogate merchant. As such, the targeting merchant is acting on the believe that its announcement will cause the consumer to repeat prior behavior by making yet another purchase at the targeting merchant within the same window of time after the subsequent purchase from the surrogate merchant. Satisfaction of the announcement condition may include passage of approximately the window of time prior to sending the announcement. Similarly, a history of other consumers making chronologically sequential purchases at a surrogate merchant and a targeting merchant can be used to derive a minimum and maximum window of time during which an announcement from the targeting merchant should be sent to any consumer detected to be proximal the surrogate merchant such that the detected consumer will be most likely to act upon the received announcement.

The announcement can be sent to a point of service terminal of the surrogate merchant, to a portable consumer device co-located with the consumer, or to both.

In one implementation, the corresponding account identifiers of the consumers 102 are used to analyze temporal or sequential shopping trends of the consumers 102 based on the data in the DB 110 and/or data in the received transaction information (*e.g.*, data that is received in real-time). The determined shopping trend can then guide the announcement condition. For example, the transaction handler (th) 206 may determine that, within an average of about two hours, 51% of the account identifiers used in the transactions with the Neiman Marcus® store are also used for the transactions with the Starbucks® store. Therefore, announcements can be sent to those consumers 102 that have already shopped with either Neiman Marcus or Starbucks. Offer made in the announcements will be more likely to be effective if they are sent within the two hour window of time described above.

The window of time may be based on the purchasing behavior of a single consumer (1) 102 or on a plurality of the consumers 102. For example, a time lapse can be determined for a sequence of transactions of the consumer (1) 102 with each of the surrogate merchant (1) 104 and the targeting merchant (2) 104. The determined time lapse can then be considered the window of time. Alternatively, a corresponding time lapse can be calculated for each of the plurality of the consumers 102 and algorithmically combined to determine the window of time. For example, the window of time may be the average of the three time lapses for three consumers (c+1, c+2, c+3) 102 (*e.g.*, 1.0 hour, 1.5 hours, and 2 hours = 1.5 hours).

The announcement may be sent to the announcement recipient within the temporal proximity (*e.g.*, the window of time) after the satisfaction of the announcement condition, which is the receipt of a subsequent transaction of the consumer (c) 102 with the surrogate merchant (m) 104 in this example. For example, the transaction handler (th) 206 may calculate the window of time based on the past transactions of the consumer (1) 102 with each of the surrogate and the targeting merchants (m) 104 to be one hour. The transaction handler (th) 206 may receive a subsequent authorization request addressed from the surrogate merchant (m) 104. The transaction handler (th) 206 may determine that the announcement condition is satisfied and send the announcement to the announcement recipient within the hour after receiving the subsequent authorization request. In this manner, the announcement, such as a coupon, can be sent to the consumer (c) 102 at an opportune time. For example, the transaction information of Sally Smith may show that, for about 70% of the time, Sally Smith purchases a coffee at the Starbucks® store within a hour of shopping at the Neiman Marcus® store. The next time Sally Smith makes a purchase at the Neiman Marcus® store, Sally Smith may receive a Starbucks® coupon, or that of a Starbucks competitor, within an hour of shopping at the Neiman Marcus® store. Sally Smith may receive the Starbucks® coupon nearly instantaneously, such as on the back of the

receipt of the subsequent transaction with the Neiman Marcus® store. Similarly, the Starbucks® coupon may be rendering on the PCD of Sally Smith as she is walking out of, and toward, the Starbucks® store, for example.

The temporal proximity may be between the utilization of the resources of the surrogate merchant (m) 104 and the transaction of the targeting merchant (m) 104. To illustrate, the transaction handler (th) 206 may determine, based on the data stored in the DB 110, that 80% of the consumers 102 that purchase a Mediterranean cruise trip tend to shop at harbor stores after commencement of the Mediterranean cruise trip. The transaction handler (th) 206 may communicate the trend analysis to the targeting merchant (m) 104. The targeting merchant (m) 104 may then specify the announcement condition based on the received trend analysis. For example, the targeting merchant (m) 104 may specify the announcement condition as “if the consumer (c) 102 has purchased a ticket on a Mediterranean cruise, then send an announcement to the consumer (c) 102 on the date that the cruise line docks at the harbor near the targeting merchant (m) 104” (the step 302). The transaction handler (th) 206 may receive the transaction information indicating that a targeted consumer (c) 102 has purchased a ticket on a Mediterranean cruise that will commence in July of 2008 (the step 304). The transaction handler (th) 206 may further use the data stored in the DB 110 to determine that the consumers 102 that purchased Mediterranean cruises booked for July 1st tend to purchase resources from harbor stores located in the spatial zone on July 15th (the step 306). The transaction handler (th) 206 may send the announcement to the targeted consumer (c) 102 on July 15th, 2008 (the step 306 and the step 312).

In yet another example, the announcement condition may be based on the real time spatial proximity of the consumer (c) 102 to the location of the surrogate merchant (m) 104. In the example above, the surrogate merchant (m) 104 may be the Neiman Marcus® store but the sending of the announcement may be triggered by the presence of the consumer (c) 102 near the Neiman Marcus® store; therefore, a transaction with the Neiman Marcus® store is not necessary. The presence of the consumer (c) 102 may be determined via a signal received from a co-located PCD, as previously described. Therefore, if the determined shopping trend shows that most of the consumers 102 that shop at the Neiman Marcus® store also tend to shop at the Starbucks® store, then the consumer (c) 102 that is near the Neiman Marcus® store may receive the Starbucks® coupon, or that of an identified competitor, even without purchasing resources at the Neiman Marcus® store. Therefore, the consumer (c) 102 need not engage in the subsequent transaction with the Neiman Marcus® store in order to trigger the receipt of the announcement containing the coupon of the targeting merchant (m) 104.

Alternatively, or in combination, the criterion of the announcement condition may be based on other shopping behaviors, such as: a relationship between the resources purchased from the surrogate merchant (m) 104 and the resources offered by the targeting merchant (m) 104 (e.g., shoes and socks, iPod® music player and iTunes® digital music, hamburger at a supermarket and George Forman® grill at a nearby retail appliance store); a relationship between the surrogate merchants 104 and the targeting merchant (m) 104 (e.g. a loyalty program giving points for purchases with either of two merchants (m+1, M+2) 104); or a relationship between consumers 102 (e.g., similar purchasing behaviors among members of a household or friends). Other criterion based on purchasing behaviors are also applicable.

In some implementations, the targeting merchant (1) 104 may pay a fee to the surrogate merchant (2) 104 for information about the transactions with the targeting merchant (1) 104 that arise as a result of the announcement being sent to the consumer (c) 102. For example, both the surrogate merchant (2) 104 and the targeting merchant (1) 104 may participate in the announcement program wherein each gives consent to the host (h) 106 to the use the transaction information corresponding to the respective merchant (m+1, m+2) 104 in the announcement program. Thereafter, if the consumer (c) 102 that received the announcement engages in the transaction with the targeting merchant (1) 104, then the targeting merchant (1) 104 would pay a fee to the surrogate merchant (2) 104 (2% of the purchase price).

Announcement About A Targeted Merchant Example

Typically, the consumer (c) 102 has access to little information about past sales of the merchant (m) 104, although the consumer (c) 102 may know the name and location (physical address or URL address) of the merchant (m) 104 and a current advertised price for a particular resource that is sold by the merchant (m) 104. Typically, the consumer (c) 102 does not have access to merchant information about the merchant (m) 104, such as: a past price of the particular resource, a sales volume of the merchant (m) 104 over a period of time, the frequency of the transactions with the merchant (m) 104 for the particular resource, whether a particular one of the consumers 102 (e.g., an identified friend, relative, or celebrity) has engaged in the transaction with the merchant (m) 104. In some instances, the merchant (m) 104 may advertise portions of a merchant information, such as the past price, but the consumer (c) 102 has no direct way to confirm the accuracy of the advertisement. For example, the merchant (m) 104 may advertise that Prada® hand bags were sold for \$5000 US last week but they are on sale for \$100 US this week. Currently, the consumer (c) 102 is not able to verify that the Prada® hand bags were, in fact, sold at the store of the merchant (m) 104 for \$5000 US last week.

In one implementation, a shopper (*e.g.*, the consumer (c) 102) receives an announcement, which includes information about past transactions of merchant (m) 104. An announcement distributor may have a shopper announcement program wherein shoppers that are eligible as announcement recipients can receive information about the past transactions of the merchant (m) 104.

The announcement distributor, the merchant (m) 104, or the announcement recipient may specify the content of the announcement (the step 308). For example, the merchant (m) 104 may: delineate the types of merchant information about the merchant (m) 104 that the announcement distributor may distribute to the announcement recipients. To illustrate, the merchant (m) 104 may delineate that the announcement content be limited to the transaction information of the merchant (m) 104 for resources having a high volume of sales over the past three months. The shopper interested in the shopper announcement program may pay a different fee for various levels of access to the merchant information.

Consumer (c) 102 may transmit a query (*i.e.*, a request) to an announcement distributor, such as a transmission requesting information about merchant (m) 104 or multiple merchants 104. The announcement distributor may receive the query and determine if the announcement condition is satisfied (step 306 in Figure 3), for example, by determining: (i) that consumer (c) 102 is one of the shoppers registered for the shopper announcement program; or (ii) that the query was submitted to the announcement distributor within the hours of operation of the announcement program. The announcement distributor may further determine if it has the proper authority or required consent(s) to distribute the announcement to the shopper by, for example, determining if local laws allow for distribution of the merchant information (the step 308). After the announcement condition is determined to be satisfied (the step 306), the announcement distributor may facilitate the delivery of the announcement to the shopper, such as by forming a transmission, addressed to the shopper and including a response to the query (the step 312).

In one implementation, the response to the request (*e.g.*, query) of the shopper may be based on data stored in the DB 110 or on transaction information as the transactions are being processed in the payment processing system 200. To illustrate, consumer (c) 102, when determined to be present in a particular spatial zone, may ask transaction handler (th) 206 to transmit the price of Prada® hand bags that have been sold within the past week at stores located in the spatial zone, such as those sold by a Neiman Marcus® store located in the spatial zone. The transaction handler (th) 206 may determine that the announcement condition is satisfied by determining if the consumer (c) 102 is an eligible announcement recipient in the shopper

announcement program (the step 306). Thereafter, the transaction handler (th) 206 may prepare the content of the announcement by: determining a merchant identifier for the Neiman Marcus® store located in the spatial zone; accessing the DB 110 to retrieve the merchant information about the Neiman Marcus® store that is located in the spatial zone; and determining, from the
5 retrieved merchant information, the price of all Prada® hand bags sold at the Neiman Marcus® store in the past week. The transaction handler (th) 206 may, in turn, form the announcement for transmission, including the determined price of the Prada® hand bags sold at the Neiman Marcus® store in the past week. Alternatively, or in a combination of the forgoing, the transaction handler (th) 206 may: determine which stores are located in the spatial zone (*e.g.* by
10 comparing the spatial zone to the known locations of a plurality of the merchants 104) and determine the price of the Prada® hand bags sold within the past week at each of the stores located in the spatial zone. The transaction handler (th) 206 may, in turn, respond to the shopper by sending the announcement to the shopper who had made the request (the step 312).

The announcement system 100 may be used for any number of shopper requests.
15 Examples of requests may include: a price paid for a resource; a confirmation that a current advertised price for the resource is less than the price paid for the resource in a past transaction; an average sales volume of each of two adjacent stores, such as when the shopper is looking to make a purchase at one of the adjacent stores; a frequency of sale of a specified resource (*e.g.*, to determine how rare the availability of the resource may be); a degree of fluctuation of prices at
20 the merchant (m) 104 (*e.g.*, to determine the likelihood that a resource will be at a different price in the near future); a frequency of co-purchasing of two resources at the merchant (m) 104 (*e.g.*, to determine if one resource is typically purchased with the other resource); a rate at which resources are returned to the merchant (m) 104 (*e.g.*, to determine the quality of the resources being sold at the merchant (m) 104); a transaction that used a loyalty redemption for the purchase
25 of a resource from merchant (m) 104 or of loyalty awards (*e.g.*, to determine if merchant (m) 104 accepts points as currency for a purchase or to determine if transactions with the merchant (m) 104 have resulted in loyalty points that the consumer (c) 102 may also be eligible for); or a query asking if a specified shopper has engaged in a transaction with the merchant (m) 104 in the past
30 (*e.g.*, to determine if a friend likes to shop at the merchant (m) 104 or whether a celebrity frequents a store of the merchant (m) 104).

Announcement About Member Consumer Transactions Examples

In these examples, a member consumer (*e.g.*, the consumers 102) of a consumer group can be an announcement recipient who will receive an announcement containing data about past transactions of other member consumers in the consumer group even if the announcement

recipient is not an account holder having an account upon which any of those past transactions was conducted. For example, a first member consumer may receive the transaction information of a second member consumer even if the first member consumer is not an account holder of the account of the second member consumer. In summary, the member consumers in the consumer group agree to share at least portions of their respective transaction histories with one another.

The member consumers can delineate the types of information that can be shared. For example, the member consumers may limit access of other member consumers to data about the manufacturers of the resources that they purchased or to the purchase prices they paid for the resources they purchased. Moreover, each member consumer may customize a type of their purchasing information that they are willing to share according to a type of member consumer in the consumer group. For instance, a member consumer can specify other member consumers in the consumer group as being a family member, a friend, or a non-acquaintance. To illustrate, if a member consumer identifies three other member consumers as being two sisters and a friend, then the two sisters will have greater access to the member consumer's transaction information than would the friend. For example, the two sisters may each receive an announcement as to the name brand, manufacturer, and price of a resource purchased by the consumer member, whereas the friend would receive an announcement containing only the manufacturer's name of the purchased resource.

Examples illustrating the purpose and usefulness of receiving announcements about past and present transactions of the member consumers in a consumer group include: receiving ads or offers for resources that are likely to be of interest to consumers (c) 102 in the consumer group; receiving announcements that recommend a resource or a merchant (m) 104 to other member consumers; receiving an announcement containing a purchase "wish list" of a member consumer; receiving an offers for a resource at a purchase price that is made available to any other member consumer in the consumer group; receiving an announcement about a gift concierge service available to the consumer group; receiving an announcement that one member consumer can pay for part of a purchase by another member consumer; receiving an announcement as that a celebrity has endorsed a resource, where the announcement can be sent or received by one or more member consumers, a merchant (m) 104, an issuer (i) 202, an acquirer (q) 204, a transaction handler (th) 206, or an agent of any of the foregoing.

In one implementation, a request can be received from a member consumer about transactions upon accounts of other member consumer(s), where the query will be understood by an announcement distributor, or agent thereof, to be a criterion of an announcement condition the satisfaction of which will trigger an announcement being sent to the requesting member

consumer. For example, the announcement sent to member consumers may include data such as: the identity of one of the member consumers; the merchant identifier of the merchant (m) 104 that sold a specified resource to one of the member consumers; an offer of the merchant (m) 104 to one of the member consumers; an average spend of one of the member consumers; a resource
5 identifier of one of the resources purchased in the past by one of the member consumers; the resource identifier of at least one resource that none of the member consumers has purchased within a specified window of time; the resource identifier of at least one resource that is predicted to be of interest to at least one of the member consumers based on the resources purchased in the past by the member consumers; the resource identifier of at least one resource
10 within a pre-selected resource set including resources of interest to the member consumers; or a manufacturer identifier of at least one resource purchased by one of the member consumers.

In another implementation, an announcement condition may be based on criteria selected by the member consumers, such as the purchase of a resource that is of interest to at least one of the member consumers. The member consumers may have a set of resources (“resource set”)
15 that is of interest to the member consumers. The announcement condition may be a change that occurs to the resource set as member consumers engage in transactions for the resources in the resource set with various merchants 104, such as a shopping “wishlist” that is tracked across the merchants 104. In another example, the member consumers may receive the announcement when one of the member consumers is present in a particular spatial zone, the announcement
20 include one or more merchants 104 that are in that zone and can engage in a transaction for a resource that is in the resource set.

Referring to Figure 5, a flowchart depicts an exemplary method 500 for notifying a member consumer of transactions (“purchases”) made by other member consumers in a consumer group from a plurality of merchants 104. At a step 502, data specifying the consumer
25 group is received. The data specifying the consumer group may include corresponding consumer identifiers usable to distinguish or identify the respective member consumers from other consumers 102 within the payment processing system 200. For example, the consumer identifier may be a legal name or other distinguishing title of the member consumer. Alternatively, or in combination of the foregoing, the consumer identifier may be: an account number of an account
30 of consumer (c) 102 who is also a member consumer in the consumer group; a telephone number of the member consumer; a random number assigned to the member consumer; a Personal Identification Number (PIN); or a digital recording of a voice of the member consumer from which the member consumer can be identified. Other forms of the consumer identifier, as are

known by those of ordinary skill in the relevant art, can also suffice to distinguish the member consumer from among the other consumers 102 that are, or are not, in the consumer group.

The consumer (c) 102 may make a selection from among other member consumers in a consumer group to form a subgroup. For example, consumer (c) 102, Sally Smith, may access an Internet website via a web enabled cellular telephone. Sally Smith may enter consumer group data during an interactive session with the website wherein Sally Smith selects three friends (consumer (c+1, c+2, c+3) 102) with whom she wants to share data about her transactions within the payment processing system 200. To make selections, consumer (c) 102 may have access through the website to consumer group data that may include data about the member consumers such as: a name of the member consumer, a consumer identifier for each member consumer, an account identifier of an account of a member consumer, an demographic of a member consumer, or the marital status of a member consumer. Once entered, the member consumer data may be stored in the DB 110 in association with the consumer group. Optionally, each of the friends may receive a transmission seeking their respective consents to be one of the member consumers or requesting other information from the member consumers, such as their account identifier.

At a step 504, a resource set is determined. This resource set may include the resources that are of interest to at least one member consumer in the consumer group. The resource set can be specified or predicted. In one implementation, at least one of the member consumers specifies at least one of the resources of interest. To illustrate, Sally Smith may specify an interest in a pair of Manolo® shoes and an IBM Thinkpad® computer, each of which is included in a resource set stored in the DB 110 in association with the consumer group. Moreover, any of Sally's three specified friends may log onto the website linked to the DB 110 and further add or delete resources in the resource set. For example, one of Sally's friends may add peaches to the resource set. Therefore, the composition of resources in the resource set may be negotiated among the member consumers, wherein some member consumers propose that a resource be included in the resource set while others respond to the proposal until an agreement is reached as to a final composition of resources in the resource set.

Alternatively, or in a combination of the foregoing, the resource set may be predicted based on the past transaction histories of each of the member consumers. In one implementation, the transaction handler (th) 206 uses an algorithm to determine transaction trends within the transaction histories of corresponding member consumers to predict the resource set. For example, the transaction history of the accounts of Sally Smith and her three (3) friends may show a trend of conducting transactions with Macy's® department stores. Consequently, the resource set may include the predicted trend: "Macy's® department store."

If the announcement condition is based on receiving a transaction of one of the member consumers for the purchase of a resource in the resource set, then the method 500 moves from the step 504 to a step 604 in Figure 6. Alternatively, or in a combination of the forgoing, if the announcement condition is based on the presence of the member consumer in a particular spatial zone, the method 500 moves from a step 504 to a step 702 in Figure 7.

At the step 604, the transaction information is received about the transactions between the merchants 104 and the consumers 102, which may include the member consumers. As previously described, the transaction information may include a resource identifier (*e.g.*, Universal Product Code (UPC), Stock Keeping Unit (SKU) or resource description) and the consumer identifier of the corresponding consumer (c) 102.

At a step 606, the transactions of the member consumers are distinguished from among the transactions of the plurality of the consumers 102. For example, the consumer identifier in the transaction information is compared with the corresponding consumer identifier of the member consumers to find a match. In the above illustration, Sally Smith may have associated a first account number of her account with the consumer group in which she is one of the member consumers. When Sally Smith engages in the transaction upon that account, the merchant (m) 104 may submit an authorization request including the first account number. The transaction handler (th) 206 may receive the authorization request within the payment processing system 200. The transaction handler (th) 206 may, in turn, match the first account number received in the authorization request with the first account number stored in the DB 110 in association with Sally Smith as one of the member consumers of the consumer group. At a step 608, the resources purchased by member consumers are compared to the resources in the resource set to determine a match. For example, the transaction handler (th) 206 may match data about the resource purchased in the received authorization request with the resources in the resource set.

Not all transactions within the payment processing system 200 of the member consumers need to be compared against the resource set. The member consumers may provide to the host (h) 106 an inclusion indicator. The host (h) 106 can use this inclusion indicator to select those transactions of member consumers that should be compared against the resource set. For example, the member consumer may set up rules that denote which of their transactions in the payment processing system 200 should be compared with data associated with the consumer group. To illustrate, the profile associated with the consumer group may indicate that only transactions with specified merchants 104 should be compared against the resource set, or that only transactions that are conducted on specified accounts should be compared against the

resource set. Other means for distinguishing the transactions of the member consumers by comparing data associated with the consumer group include: matching a consumer group code (e.g., PIN) that the member consumer enters during the transaction with the consumer group code associated with the consumer group in the DB 110; using a query response session during
5 the transaction to obtain from the member consumer information to be compared to data associates with the consumer group; or providing consumer members of the consumer group with a pseudo account number for use in their transactions. For example, the member consumer may enter a special code into a Point of Service terminal (POS) of the merchant (m) 104 during a transaction that indicates that information obtained from the transaction should be compared to
10 the data associated with the consumer group.

The pseudo account number may be linked with respective accounts of each member consumer within the payment processing system 200. For example, each of the member consumers may receive a corresponding PCD specific to the consumer group, such as a payment card that is associated with or otherwise identifies the pseudo account number. When the
15 member consumer conducts a transaction on the pseudo account number, the transaction is sent to the transaction handler (th) 206 that recognizes the pseudo account number, routes the transaction to the corresponding account of the member consumer that is linked to the pseudo account number, and compares data from the transaction with the data associated with the consumer group. Other techniques effective to distinguish the transactions of the member
20 consumers are also contemplated for use in the disclosed implementations.

At a step 610, a notice function is performed if the resources purchased match the resources in the resource set. The notice function may include sending the announcement to the member consumer. The announcement may include information such as: a purchase price of the matched resource; a time that the matched resource was purchased; the consumer identifier (e.g.,
25 a name of the member consumer that purchased the matched resource); a date that the matched resource was purchased; a resource identifier of the matched resource; a manufacturer identifier of the matched resource; a message from one of the member consumers; information about a location of one of the member consumers; an offer of the merchant (m) 104 for the resource sold to one of the member consumers; an average purchase amount of one of the resources purchased
30 by the member consumers; the resource identifier of a resource that none of the member consumers has purchased within a specified window of time; the resource identifier of one of the resources in the predicted or selected resource set; or an alert that payment processing system 200 has received an authorization request a transaction to purchase of one of the resources of interest. To illustrate, if Sally Smith purchases the peaches, which resource is matched in the

resource set, then the announcement may be sent to one of her three friends with the included text: "The peaches from your resource set have just been purchased."

The resource set may be changed or updated based on the comparison between the resources in the resource set and the resources purchased by the member consumers. For example, resources in the resource set may be removed as member consumers purchase them or added as the resource set is predicted based on the transaction history of the member consumers. For example, if a resource set consists of mutually exclusive wedding gifts to be purchased by member consumers in a consumer group, each purchase of each gift removes a resource in the resource set until all of the wedding gifts have been purchased and the resource set is devoid of resources.

Each member consumer may receive an announcement that includes information about the resource set that is of interest specifically to them. In one implementation, a subset of the predicted resource set is determined and included in the announcement to a first member consumer. The subset may be based on the transaction history of the first member consumer. For example, the resource set may include a Rolex® watch, a Cadillac® vehicle, peaches, and an Apple® iPod® music player. The transaction history of the first member consumer, Sally Smith, may show that Sally Smith typically makes purchases in a range of \$1 US to \$1000 US. Therefore, the announcement sent to Sally Smith may only include information about the resources that have a purchase price in this range, such as the peaches and the Apple® iPod® music player. In another example, if the transaction history for Sally shows that she has already bought the resource in the resource set, she will not receive the announcement about that resource. For example, if the resource set includes a Spaghetti lunch at Cibo™ restaurant, but the transaction history of Sally Smith shows that Sally Smith has already eaten there this week, then Sally Smith won't receive the announcement including a coupon for the Spaghetti lunch at Cibo™ restaurant, while the other member consumers may receive the coupon. Similarly, individual member consumers can opt-in or out of receiving selected announcements.

In another implementation, the announcement condition may be based on the presence of the member consumer in a specified spatial zone, in which case, the method 500 moves from a step 504 to a step 702 in Figure 7. At a step 704, data usable to determine a location of a first consumer (c) 102 is received. As previously described, a co-located PCD can transmit information from which a location of the consumer (c) 102 to the host (h) 106. At a step 706, a determination is made as to whether the first consumer (c) 102 is one of the member consumers of the consumer group. For example, if the received data in the step 704 includes the consumer identifier of the first consumer (c) 102 (e.g., an account number or telephone number associated

with the first consumer (c) 102), then the received consumer identifier is compared against the consumer identifiers stored in the DB 110 in association with the consumer group.

At a step 708, the location of the first consumer (c) 102 is determined from the transmitted information. For example, the host (h) 106 (*e.g.*, the transaction handler (th) 206) may receive a transmission that includes GPS or local area network coordinates from which the location of the first consumer (c) 102 can be determined. The host (h) 106, may translate the coordinates into a physical address, such as a street address. At a step 710, the determined location of the first consumer is matched with the zone of interest. For example, the determined street address of the first consumer (c) 102 may be compared to the geographic boundaries of the spatial zone to determine if the first consumer (c) 102 is located within the spatial zone.

At a step 712, a notice function is performed if the determined location of the first consumer (c) 102 matches the zone of interest. The notice function may include forming the announcement for delivery to one of the member consumers including information about potential purchasing announcement opportunities. For example, Sally Smith is determined to be in the spatial zone that includes the merchant (m) 104 who can sell the IBM ThinkPad® computer which is one of the resources in the resource set. The notice function may be a transmission of a message to Sally Smith's cellular telephone that the merchant (m) 104 is selling the IBM ThinkPad® computer. Alternatively, or in combination, one of Sally's friends in the consumer group may receive the announcement indicating that Sally is near the merchant (m) 104 who is sells the IBM ThinkPad® computer. Thereafter, one of her friends may call Sally Smith to pass on the information about the merchant (m) 104.

Other implementations of the "Announcement About Member Consumer Transactions Examples" are described below including: (a) Wishlist, (b) Common Purchase Price (c) Automated Gift Concierge, (d) Pooled Money, and (e) Celebrity Endorsement.

(a) Wishlist

The announcement system 100 may be used to create a wishlist (*e.g.*, resource set) of resources that the consumer (c) 102 is interested in. The consumer (c) 102 can create a consumer group (the step 502), including denoting the member consumers in the consumer group. Each of the member consumers may have access to the wishlist which includes resources that may be purchased from any of a number of the merchants 104 (the step 504). The wishlist is edited or updated as the member consumers make purchases of resources on the wish list using any of a number of the accounts that are associated with the consumer group. For example, the wishlist may include a Microsoft® Xbox and a toy train. The transaction handler (th) 206 may receive a transaction from a first merchant (m) 104 for the Microsoft® Xbox, where the transaction was

conducted upon one of the accounts associated with the consumer group (the step 604). The transaction handler (th) 206 may: identify the Microsoft® Xbox as one of the resources in the resource set (the step 608), remove the Microsoft® Xbox from the wishlist and inform the member consumers that the Microsoft® Xbox is no longer on the wishlist (the step 610).

5 Similarly, if one of the member consumers is determined to be near a toy shop selling toy trains (the steps 704, 706, 708, and 710), the transaction handler (th) 206 can facilitate the delivery of a notice to the member consumer near the toy shop that the toy train may be purchased at the toy shop (the step 712).

(b) Common Purchase Price

10 The announcement system 100 may be used to offer resources to the member consumer at a purchase price that is similar to the purchase price paid by another member consumer. Here, the member consumers may create the resource set that includes resources that a plurality of the member consumers are interested in purchasing (the steps 502 and 504). The announcement condition can be selected to be the purchase of one of the resources in the resource set by one of
15 the member consumers. The host (h) 106 may receive the plurality of transactions (the step 604) and distinguish the transactions of the member consumer(s) with the merchant (m) 104 for the resource in the resource set (the steps 606, and 608)), and facilitate the sending of the announcement to the other member consumers (the step 610). The announcement may include information such as the purchase price of the purchased resource, the name of the member
20 consumer that purchased the resource, or a description of the merchant (m) 104 that sold the resource to the member consumer.

The announcement may include an offer of the merchant (m) 104 for the resource at a discount price that matches the purchase price of the distinguished transaction. In this manner, member consumers can receive the same deal or a better deal than those received by the other
25 member consumers in the consumer group. The offer may be tailored to the member consumer, such as “Your friend just bought a Super Mario® Wii® computer game for \$100 US. We can give you the same deal!”

(c) Automated Gift Concierge

The announcement system 100 may provide a gift concierge function to the member
30 consumers. For example, three of consumers 102 may create a consumer group (the step 502) wherein the member consumers consent to sharing their respective transaction information with one another. One of the three member consumers, such as Sally Smith, may wish to purchase a gift for another of the three member consumers 102 (“friend”). Sally Smith may transmit an inquiry to the host (h) 106 (*e.g.*, the transaction handler (th) 206) requesting information about

the past shopping habits of her friend. For example, Sally Smith may request information about the resources that her friend bought, merchants 104 that her friend has purchased from, or the manufacturers of the resources that her friend typically buys (*e.g.*, the step 504). To illustrate, Sally Smith may inquire “What clothing designer does my friend typically use?” or “Has my friend ever purchased music from iTunes® music service in the past?” or “Does my friend like Sears® products?” Thereafter, the host (h) 106 may: search the transaction information stored in the DB 110 to locate the transactions of her friend (the steps 604, 606, and 608) and then facilitate the electronic transmission to Sally Smith (the step 610) of the announcement that includes the information that Sally requested.

Alternatively, or in a combination of the forgoing, Sally Smith may receive an unsolicited announcement indicating that her friend is making a purchase. For example, Sally Smith may receive a message on her cellular telephone that the friend is about to purchase a cup of coffee. This may be initiated, for instance, by the transaction handler (th) 206 receiving an authorization request for her friend's purchase of coffee upon her friend's account. The transaction handler (th) 206 may: determine that the friend is one of the member consumers of the consumer group that includes Sally Smith, and initiate the transmission of the message that arrives at Sally's cellular telephone to inform Sally Smith that her friend is in the coffee shop. Again, such an announcement would be triggered by the satisfaction of predetermined announcement conditions that are associated with the consumer group. Sally Smith may then offer, by use of her cellular telephone, to pay for her friend's coffee purchase by sending a transmission to the payment processing system 200 (*e.g.*, the transaction handler (th) 206) consenting to make the coffee purchase payable upon the account of Sally Smith. Sally Smith may also request that an electronic message be sent indicating “This one is on me, Sally.” In turn, the transaction handler (th) 206 may send an e-mail message to the portable consumer device of her friend that includes Sally's message.

(d) Pooled Currency

In another implementation the member consumers may wish to make a group purchase wherein a resource is purchased with currency from a plurality of corresponding accounts of the member consumers as partial payment toward the group purchase. The partial payments may be processed separately wherein each partial payment is authorized, cleared, and settled individually within the payment processing system 200. Alternatively, or in a combination of the forgoing, the currency may be first pooled together in a mutual account and the transaction for the resource then processed as payable upon the mutual account.

To illustrate, the consumer group may be created. The member consumers in the consumer group may wish to purchase a “gift” for a friend that is not in the consumer group, wherein the resource set is “gift.” The “gift” may be identified, such as a Mont Blanc® pen for \$500 US from merchant (1) 104. Alternatively, the gift may be unidentified. The member consumers may each submit a corresponding request to the transaction handler (th) 206 requesting that currency (*e.g.*, money or loyalty points) be transferred from their respective account as partial payment towards the gift. The request may include the account identifier of their account and an amount of the currency to transfer as the partial payment. The transaction handler (th) 206 may process each partial payment individually or pool the currency together in a mutual account prior to processing the transaction(s) for the gift. The member consumers may receive announcements including the status of the partial payments, such as an indication of how much more currency is needed in order to cover the cost of the gift.

In one implementation, the transaction handler (th) 206 processes the partial payments individually. The transaction handler (th) 206 may submit each partial payment authorization request individually to each respective issuer (i) 202 of the corresponding accounts of the member consumers. Thereafter, each of the partial payments may be cleared and settled such that the merchant (1) 104 selling the gift receives each partial payment for the gift from each of the corresponding accounts. The transaction handler (th) 206 may, but need not, first store the information in each request until there is enough currency in the requests to cover the purchase price of an identified gift. Once there is enough currency in the requests to cover the cost of the gift, the transaction handler (th) 206 may process each of the partial payments for corresponding authorizations, clearing, and settlements.

In another implementation, the member consumers may have access to a mutual account in which the currency for the gift can first be pooled. The transaction handler (th) 206 may: receive the requests for the partial payments; request the corresponding issuers (i) 202 of the member consumers to transfer the amount of the partial payment to the mutual account (*e.g.*, authorize, clear, and settle a transfer of the funds to the mutual account) such that the mutual account carries a balance including the sum of the currency amounts of the partial payments. The transaction handler (th) 206 may then process a transaction with the merchant (m) 104 selling the gift payable upon the mutual account (*e.g.*, the transaction with the merchant (m) 104 is authorized, cleared, and settled upon the mutual account).

To illustrate, the member consumers may be co-workers in an office. Each co-worker may wish to contribute money toward the purchase of a gift for their boss worth \$30 US. Each member consumer may log onto a website wherein the member consumers enter a request to

transfer money from a corresponding identified account of the co-worker (*e.g.*, \$5 US from a first co-worker, \$10 US from a second co-worker, and \$15 US from a third co-worker) as partial payment toward the gift. If the merchant (1) 104 is also identified, the transaction handler (th) 206 may receive the requests and send an authorization request to each respective issuer (i) 202 of the corresponding identified accounts to authorize each respective partial payment. If the merchant (1) 104 is not identified, the transaction handler (th) 206 may either store the respective requests in the DB 110 until such time that the merchant (1) 104 is identified, or send instructions to each respective issuer (i) 202 of the corresponding identified accounts to transfer funds corresponding to the respective partial payment to the mutual account. The mutual account can hold the transferred money until such time that the transaction for the gift is conducted upon the mutual account.

The member consumers may receive the announcement about the pooled currency. For example, the member consumers may receive the announcement including information about how much money has been collected toward the gift and how much money still remains to be collected. In another example, the member consumers may receive the announcement including information about the gift that was bought with the pooled currency. In yet another example, the gift recipient may receive the gift (*e.g.*, a prepaid card loaded with the pooled currency) along with a note from each of the member consumers that made a partial payment toward the gift.

(d) Celebrity Endorsement

The member consumers need not know each other personally. In one implementation, the member consumers in the consumer group may include an endorser (*e.g.*, a celebrity endorser that shops with merchants 104), wherein the member consumers are interested in knowing about the purchases of the endorser at these merchants. For example, a celebrity endorser may engage in a contract with an endorsee, wherein the celebrity may receive compensation if the celebrity agrees to be part of the consumer group. Once the celebrity is included as one of the member consumers of the consumer group, other member consumers can receive announcements about the transactions of the celebrity, such as the transactions of the celebrity conducted on a specified account.

Here, the transaction handler (th) 206 may process, within the payment processing system 200, the transactions of an endorser upon an account of the endorser that is funded by the endorsee (*e.g.*, the merchant (m) 104 that has engaged in the endorsement contract with the endorser). In one implementation, the transaction handler (th) 206 may receive an authorization request for the transaction of the endorser on the account. The authorization request may include a code usable to distinguish the merchant (m) 104 as one of the endorsee's. The transaction

handler (th) 206 may use the code in the authorization request to distinguish the merchant (m) 104 that engaged in the transaction with the endorser as one of the endorsees. The transaction handler (th) 206 may send an authorization response, which is responsive to the authorization request, for delivery to the merchant (m) 104 that submitted the authorization request.

5 Thereafter, the transaction of the endorser may be cleared and settled within the payment processing system 200 as is known by those of ordinary skill in the relevant art.

Each of the endorsees of the account of the endorser may submit funds to the account. They may each transfer a set amount of funds to the account at a preset schedule, as denoted by the endorsement contract. Alternatively, or in combination, each of the endorsees may receive a
10 statement at the end of a preset period indicating an amount of funds that each of the endorsees need to forward to the account of the endorser. To illustrate, the endorser purchased \$50 US of resources from a first endorsee franchisee store, thus the franchisor must forward \$50 US plus any applicable fees to the account of the endorser. Thereafter, the first endorsee franchisee store may clear and settle the transaction with the endorser such that the first endorsee franchisee is
15 forwarded the \$50 US from the account of the endorser.

Alternatively, the transaction of the endorser may not be cleared and settled such that funds are not transferred to the merchant (m) 104 for the transaction. For example, if the merchant (1) 104 is one of the endorsees, then the merchant (1) 104 may not wish to transfer funds into the account only to receive the funds back from the account. Rather, the merchant (1)
20 104 may simply wish to reconcile the submitted authorization request. Here, the transaction handler (th) 206 may send, to the endorsee engaged in the transaction with the endorser, data usable to reconcile the transaction with the endorser. For example, the data may include indicia about: the resource purchased (*e.g.*, a SKU), the value of the resource, or the frequency of transactions of the endorser with the endorsee. In one implementation, the endorsee may
25 reconcile the received data by comparing the received data with: submitted authorization requests, logs of transaction of the endorsee, or the terms of the endorsement contract.

To illustrate, Tiger Woods, a golf celebrity, may enter a contract to endorse Nike® products, Starwood® resorts, and PF Chang® restaurants (collectively, “the Endorsees”). As part of the endorsement agreement, Tiger Woods becomes one of the member consumers in the
30 consumer group and is issued an endorsement account within the payment processing system 200, wherein the transaction data for the transactions on the endorsement account can be announced to other member consumers. Tiger Woods may then engage in transactions upon the endorsement account for the resources of any of the Endorsees. Each of the Endorsees would fund the purchase of the corresponding resource of the respective Endorsee that was made by

Tiger Woods. In this manner, Tiger Woods would receive the resources without paying for them and in return, the member consumers (e.g., fans of Tiger Woods) would receive announcements about purchases of Tiger Woods. Therefore, if Tiger Woods purchases blue Nike® tennis shoes from a merchant, his fans would receive an announcement indicating the details of purchase of the blue Nike® tennis shoes, and Nike Corporation would pay the merchant for the blue Nike® tennis shoes. Moreover, the fans may receive, in the announcement, a coupon for the blue Nike® tennis shoes from those merchants 104 that also sell the blue Nike® tennis shoes, or the coupon may be for any product manufactures by Nike Corporation. The Endorsees may set limits on the purchases that the celebrity may make. For example, one of the Endorsees may set a payment limit for an amount of funds that the respective endorsee is willing to pay for the transaction upon the endorsement account.

Additional Exemplary Implementations

Various examples of implementations are set forth in the following numbered paragraphs each of which corresponds, as indicted below, to a US patent application incorporated herein by reference in the paragraph above labeled "Cross-Reference To Related Applications" and each being enabled by the disclosure of the specification and drawings of this application:

Exemplary implementations corresponding to US Patent Application Serial No. 12/428,302, filed on April 22, 2009, titled "Receiving An Announcement Triggered By Location Data," as Attorney Docket No. P-14248US (930676.00116):

1. A computer implemented method for announcing to an announcement recipient that a consumer is located within a region that is of interest to a merchant, the computer implemented method comprising the steps of:
 - specifying to an announcement distributor, using a computing apparatus executing software, an announcement condition that includes presence of a first said consumer within the region that is of interest to the merchant;
 - and
 - receiving, using the computing apparatus executing the software, a first electronic transmission including the announcement from the announcement distributor, wherein the receiving step occurs after the announcement condition has been satisfied and while the first said consumer is within the region.
2. The computer implemented method as defined in Exemplary Implementation No. 1 further comprising the step of using a point of interaction terminal, co-located with a second

said consumer, to form an authorization request for a transaction upon a payment account of the second said consumer, wherein the authorization request is usable to:

electronically match the second said consumer with the first said consumer; and

electronically determine a location of the second said consumer in order to compare the determined location with the region.

3. The computer implemented method as defined in Exemplary Implementation No. 1 further comprising the step of receiving, using the computing apparatus executing the software, a second transmission including data usable to:

determine a location of a second said consumer; and

match the second said consumer to the first said consumer.

4. The computer implemented method as defined in Exemplary Implementation No. 3 wherein:

the second said consumer is co-located with a portable consumer device; and

the second transmission is addressed from the portable consumer device that is selected from the group consisting of:

a financial card;

a contactless device including a wireless processor, a transmitter, and a receiver;

a smart card;

a cellular telephone;

a personal digital assistant;

a digital audio player;

a global positioning system enabled device;

a computer; and

a combination of any of the above portable consumer devices.

5. The computer implemented method as defined in Exemplary Implementation No. 1 wherein the step of specifying the announcement condition further comprises the step of specifying, using the computing apparatus executing the software, at least one required account transaction history of a payment account of the first said consumer.

6. The computer implemented method as defined in Exemplary Implementation No. 5 wherein the at least one required transaction history is selected from the group consisting of:

a tendency to purchase resources matching that of the merchant;

a transaction, conducted within the region, upon the payment account;

and

a category of the payment account.

7. The computer implemented method as defined in Exemplary Implementation No. 1 further comprising the step of, subsequent to receiving the announcement, using the computing apparatus executing the software to facilitate a communication from the announcement recipient to the first said consumer while the first said consumer is within the region.

5 8. The computer implemented method as defined in Exemplary Implementation No. 1 wherein the announcement recipient is selected from the group consisting of:

a merchant;

an acquirer of the merchant;

an issuer that has issued an account to a corresponding said consumer;

10 a transaction handler; and

any combination thereof, wherein:

the transaction handler processes a plurality of transactions, each between a corresponding said merchant and a corresponding said consumer;

15 each said transaction is upon a corresponding account of the corresponding said consumer;

each of the merchants submits a corresponding said transaction to a corresponding acquirer for processing by the transaction handler who requests a corresponding issuer to obtain payment for the corresponding said transaction from the corresponding account; and

20 the corresponding issuer forwards the obtained payment for delivery to the corresponding acquirer to pay the submitting said merchant for the submitted said transaction.

9. A computer implemented method announcing information about a consumer to a merchant, the computer implemented method comprising the steps of:

25 forming, using a computing apparatus executing software, a first transmission that is addressed to an announcement distributor and includes:

a merchant indicator usable to determine a merchant address of the merchant; and

an announcement condition, wherein the announcement condition is satisfied

30 when at least one preset criterion matches information derived from data received from a first portable consumer device of a first consumer;

and

receiving, using the computing apparatus executing the software, an announcement at the merchant address from the announcement distributor after the announcement condition is satisfied, wherein the announcement:

includes the derived information; and
is received in close temporal proximity to a time that the announcement condition is satisfied.

10. The computer implemented method as defined in Exemplary Implementation No. 9 further comprising the step of forming, using the computing apparatus executing the software, a second electronic transmission, addressed to the announcement distributor, including the merchant indicator and data received from a second said portable consumer device that is co-located with a second said consumer, wherein the data received from the second said portable consumer device is usable to determine whether the announcement condition is satisfied.

11. The computer implemented method as defined in Exemplary Implementation No. 10 wherein the second electronic transmission includes an authorization request for a transaction upon a second payment account that is associated with the second said portable consumer device.

12. The computer implemented method as defined in Exemplary Implementation No. 10 wherein the data received from the second said portable consumer device is received at a terminal selected from the group consisting of:

- a point of interaction terminal of the merchant;
- a near field communication terminal of the merchant;
- a far field communication terminal of the merchant; and
- a combination thereof.

13. The computer implemented method as defined in Exemplary Implementation No. 9 wherein the preset criterion is selected from the group consisting of:

- a spatial region in which the first portable consumer device is to be located;
- a consumer demographic;
- a window of time for receiving the data from the first portable consumer device;
- a transaction history of a payment account associated with the first portable consumer device and indicating a tendency to purchase a resource matching that of the merchant;
- a category of the payment account; and
- a combination of any of the above preset criterion.

14. The computer implemented computer implemented method as defined in Exemplary Implementation No. 9 wherein:

- the preset criterion includes presence of the first consumer within a spatial zone as derived from the data received from the first portable consumer device; and
- the close temporal proximity is a time period that the first consumer is located within the spatial zone.

15. A merchant apparatus comprising a computer readable medium including stored instructions that, when executed by a computing device, the computing device performs the steps of:

specifying to an announcement distributor an announcement condition that includes
5 presence of a first portable consumer device of a consumer within a spatial region;

and

receiving an announcement about the consumer after the announcement condition has been satisfied and while the first portable consumer device is within the spatial region.

16. The merchant apparatus as defined in Exemplary Implementation No. 15 wherein
10 the computer readable medium further comprises stored instructions that, when executed by the computing device, the computing device performs the step of forming an electronic transmission for delivery to the announcement distributor and including data usable to:

determine a location of a second said portable consumer device; and

match the second portable consumer device to the first said portable consumer device.

17. The merchant apparatus as defined in Exemplary Implementation No. 16 wherein
15 the computer readable medium further comprises stored instructions that, when executed by the computing device, the computing device performs the step of receiving the usable data from the second said portable consumer device of a second said consumer.

18. The merchant apparatus as defined in Exemplary Implementation No. 16 wherein:
20 the announcement condition further includes a required first direction of movement of the first consumer; and

the usable data is further usable to:

determine a second direction of movement of the second said consumer; and

match the required first direction with the second direction.

19. The merchant apparatus as defined in Exemplary Implementation No. 15 wherein
25 the electronic transmission is an authorization request for a payment transaction upon a corresponding account associated with the second said portable consumer device.

20. The merchant apparatus as defined in Exemplary Implementation No. 15 wherein
30 the announcement includes at least one of:

an indication of a number of times the first portable consumer device has been in the spatial region over a window of time; and

an indication that the consumer has engaged in a payment transaction upon a payment account while the first portable consumer device has been in the spatial region.

Exemplary implementations corresponding to US Patent Application Serial No. 12/428,349, filed on April 22, 2009, titled "Location Based Processing Of Announcements For Delivery To An Announcement Recipient," as Attorney Docket No. P-14251US (930676.00155):

- 5 1. A computer implemented method comprising the steps of:
 associating, using a computing apparatus executing software, an announcement recipient with a predetermined zone;
 receiving, using the computing apparatus executing the software, an electronic transmission containing information sufficient to determine a location of a first consumer;
10 determining from the information, using the computing apparatus executing the software, if the location is within the predetermined zone;
 and
 when the location is determined to be within the predetermined zone:
 identifying, using the computing apparatus executing the software, an address of the
15 announcement recipient associated with the predetermined zone; and
 transmitting, using the computing apparatus executing the software, an announcement, for delivery to the identified address, that the first consumer is located within the predetermined zone.
2. The computer implemented method as defined in Exemplary Implementation No.
20 1 further comprising the steps of:
 obtaining, using the computing apparatus executing the software, target consumer data;
 and
 comparing, using the computing apparatus executing the software, the target consumer data with the received information to find a match, wherein the announcement further includes at
25 least a portion of the target consumer data.
3. The computer implemented method as defined in Exemplary Implementation No.
 1 further comprising the steps of:
 determining from the information, using the computing apparatus executing the software, a first direction of movement of the first consumer; and
30 comparing, using the computing apparatus executing the software, the first direction of movement to an announcement condition direction to find a match, wherein the step of transmitting the announcement occurs after the match of the announcement condition direction is found.

4. The computer implemented method as defined in Exemplary Implementation No. 1 wherein the electronic transmission includes an authorization request for a transaction upon a payment account associated with the first consumer.

5. The computer implemented method as defined in Exemplary Implementation No. 1 wherein the electronic transmission is addressed from at least one of:

- a first portable consumer device of the first consumer;
- a second portable consumer device of a second consumer that is communicatively linked to the first portable consumer device of the first consumer;
- a point of interaction terminal that is co-located with the first consumer;
- 10 a near field communication terminal that is co-located with the first consumer; and
- a far field communication terminal that is co-located with the first consumer.

6. The computer implemented method as defined in Exemplary Implementation No. 1 wherein:

15 the first consumer is associated with an account that is issued by an issuer within a payment processing system; and

- the announcement includes at least one of:
 - a name of the first consumer that is associated with the account;
 - an account category of the account;
 - a transaction history of the account indicating a frequency of purchases of a specific type
 - 20 of resource;
 - a demographic of the first consumer that is associated with the account; and
 - information about a transaction upon the account conducted with a merchant located within the predetermined zone.

7. The computer implemented method as defined in Exemplary Implementation No. 1 wherein the announcement recipient is selected from the group consisting of:

- a merchant;
- an acquirer of the merchant;
- an issuer that has issued an account to a corresponding said consumer;
- a transaction handler; and
- 30 any combination thereof and, wherein:
 - the transaction handler processes a plurality of transactions, each between a corresponding said merchant and a corresponding said consumer;
 - each transaction is associated with an account of one of the consumers;

each of the merchants submits corresponding said transactions to at least one of the acquirers for processing by the transaction handler who requests corresponding said issuers to obtain corresponding payments for the corresponding said transactions from corresponding said consumer accounts; and

5 the corresponding said issuers forward the obtained corresponding payments to the at least one of the acquirers to pay the submitting said merchant for the submitted corresponding said transactions.

8. A computer implemented method for announcing data about a consumer to an announcement recipient, the computer implemented method comprising the steps of:

10 specifying, using a computing apparatus executing software, an announcement condition that includes at least a presence, within a spatial zone of interest to a first merchant, of a portable consumer device associated with the consumer;

obtaining, using the computing apparatus executing the software, target information including:

15 a code usable to determine an account identifier associated with an account issued to the consumer by an issuer within a payment processing system; and

location data usable to determine a location of the portable consumer device;

determining, using the computing apparatus executing the software, the account identifier using the code;

20 receiving, using the computing apparatus executing the software, data about the consumer corresponding to the account identifier;

determining, using the computing apparatus executing the software, the location of the portable consumer device from the location data;

25 comparing, using the computing apparatus executing the software, the determined location of the portable consumer device to the spatial zone to determine when the announcement condition is satisfied; and

30 forming, using the computing apparatus executing the software, a first transmission including at least a portion of the obtained data about the consumer, wherein the first transmission is for delivery to an announcement recipient after the announcement condition is satisfied.

9. The computer implemented method as defined in Exemplary Implementation No. 8 further comprising the step of transmitting, using the computing apparatus executing the software, the first transmission for delivery to the announcement recipient while the portable consumer device is in the spatial zone.

10. The computer implemented method as defined in Exemplary Implementation No. 8 further comprising the step of forming, using the computing apparatus executing the software, a second transmission for delivery to the announcement recipient including a history of a plurality of the first transmissions previously formed.

5 11. The computer implemented method as defined in Exemplary Implementation No. 8 wherein the first transmission further includes at least one of:

a frequency of the presence of the portable consumer device within the spatial zone over a period of time; and

10 an indication that the consumer has engaged in a payment transaction upon the account while the portable consumer device has been present within the spatial zone.

12. The computer implemented method as defined in Exemplary Implementation No. 8 wherein:

15 the step of obtaining target consumer information includes receiving, using the computing apparatus executing the software, an authorization request for a payment transaction upon the account; and

the payment transaction is between the consumer and a second merchant.

13. The computer implemented method as defined in Exemplary Implementation No. 8 wherein the first merchant has a place of business located within the spatial zone.

20 14. The computer implemented method as defined in Exemplary Implementation No. 8 wherein the step of specifying the announcement condition includes receiving, using the computing apparatus executing the software, a second transmission from the announcement recipient that specifies the announcement condition.

15 15. The computer implemented method as defined in Exemplary Implementation No. 8 wherein the portable consumer device is selected from the group consisting of:

25 a financial card;

a contactless device including a wireless processor, a transmitter, and a receiver;

a smart card;

a cellular telephone;

a personal digital assistant;

30 a set-top box;

a computing apparatus; and

a combination of any of the above portable consumer devices.

16. The computer implemented method as defined in Exemplary Implementation No. 8 wherein the location data includes at least one of:

a merchant identification code associated with a corresponding said merchant having a known location;

an altitude of the portable consumer device;

a latitude of the portable consumer device;

5 a longitude of the portable consumer device;

a World Geodetic System coordinates of the portable consumer device;

data usable to determine a direction of movement of the portable consumer device; and

data usable to determine a speed of the portable consumer device.

17. An apparatus comprising a computer readable medium including stored
10 instructions that, when executed by a computing apparatus, the computing apparatus performs the steps of:

specifying an announcement condition that includes presence of at least one consumer within a spatial zone that is of interest to a merchant;

receiving a transmission including data usable to:

15 determine a location of a first said consumer; and

match the first said consumer to the at least one consumer;

using the data in the transmission to:

determine the location of the first said consumer; and

match the first said consumer with the at least one consumer;

20 determining that the announcement condition has been satisfied by at least matching the determined location of the first said consumer with the spatial zone;

and

forming an announcement about the at least one consumer for delivery to an announcement recipient, wherein the announcement is for delivery to the announcement
25 recipient after the announcement condition has been satisfied and while the first said consumer is located in the spatial zone.

18. The apparatus as defined in Exemplary Implementation No. 17 wherein:

the first said consumer is associated with a payment account that is issued by a corresponding issuer within a payment processing system;

30 account information associated with the account is stored in a database within the payment processing system; and

determining that the announcement condition has been satisfied further includes matching the corresponding said account information with at least one of:

a required account characteristic;

a required tendency to purchase a specific type of resource; and

a required demographic, wherein the corresponding said account information includes a corresponding demographic.

19. The apparatus as defined in Exemplary Implementation No. 17 wherein the step
5 of specifying the announcement condition includes receiving a second transmission from the announcement recipient that specifies the announcement condition.

20. The apparatus as defined in Exemplary Implementation No. 17 wherein the step of determining that the announcement condition has been satisfied further includes:

determining a first direction of movement of the first said consumer; and

10 determining that the first direction of movement matches an announcement condition direction.

Exemplary implementations corresponding to US Patent Application Serial No. 12/428,283, filed on April 22, 2009, titled "Receipt of Communications From Announcement Recipients of Consumer Data," as Attorney Docket No. P-14247US (930676.00115):

1. A computer implemented method for an announcement recipient to communicate with a consumer after the announcement recipient has received an announcement about the
20 consumer, the computer implemented method comprising the steps of:

specifying, using a computing apparatus executing software, a selected said announcement recipient and at least one announcement condition including a presence of the consumer within in a zone, wherein the selected said announcement recipient receives the corresponding announcement after the announcement condition is satisfied;

25 and

receiving, using the computing apparatus executing the software, a communication, addressed from the announcement recipient, that is responsive to the announcement received by the announcement recipient, wherein the receiving of the communication occurs while the consumer is present in the zone.

30 2. The computer implemented method as defined in Exemplary Implementation No. 1 wherein the zone is selected from the group consisting of:

a spatial zone;

an Internet Zone;

a virtual zone; and

a combination thereof.

3. The computer implemented method as defined in Exemplary Implementation No. 1 wherein:

5 the selected said announcement recipient is a merchant located in the zone; and
the communication includes an offer for resources of the merchant.

4. The computer implemented method as defined in Exemplary Implementation No. 3 wherein the computer is a portable consumer device selected from the group consisting of:

a contactless device including a wireless processor, a transmitter, and a receiver;
a smart card;
10 a cellular telephone;
a personal digital assistant;
a digital audio player enabled device;
a portable global positioning system enabled device; and
a combination of any of the above portable consumer devices.

15 5. The computer implemented method as defined in Exemplary Implementation No. 1 further comprising the step of providing, using the computing apparatus executing the software, information usable to determine when the at least one announcement condition has been satisfied.

6. The computer implemented method as defined in Exemplary Implementation No. 20 5 wherein the information includes position data obtained from at least one of:
a global positioning system receiver;
a gyroscope; and
an accelerometer.

7. The computer implemented method as defined in Exemplary Implementation No. 25 1 wherein the at least one announcement condition further includes a required direction of movement for the consumer.

8. The computer implemented method as defined in Exemplary Implementation No. 1 wherein the announcement recipient is selected from the group consisting of:
a merchant;
30 an acquirer of the merchant;
an issuer that has issued an account to the consumer;
a transaction handler; and
any combination thereof and, wherein:

the transaction handler processes a plurality of transactions each between a corresponding said merchant and a corresponding said consumer;
each transaction is upon a corresponding said account of one of the consumers;
each of the merchants submits said transactions to corresponding said acquirers
5 for processing by the transaction handler who requests corresponding said issuers to obtain corresponding payments from corresponding said accounts for the submitted said transactions; and
the corresponding said issuers forward the obtained said corresponding payments to the corresponding said acquirers to pay the submitting said merchants for
10 corresponding submitted said transactions.

9. An apparatus for use with a system where an announcement condition includes presence of a consumer within a zone of interest to at least one announcement recipient, the system including an announcement distributor providing an announcement about a location of the consumer to at least one announcement recipient after the announcement condition occurs,
15 the apparatus comprising a computer readable medium including stored instructions that, when executed by a computing device, the computing device performs the steps of:

receiving positioning data from which a location of the apparatus can be determined, wherein the apparatus is co-located with the consumer;
determining the location of the apparatus using the positioning data;
20 forming a transmission, for delivery to the announcement distributor, including the determined location;
and
receiving a communication addressed from the at least one announcement recipient after the at least one announcement recipient has received the announcement, wherein:
25 the announcement includes data based on the determined location; and
the announcement recipient is selected from the group consisting of:
a merchant;
an acquirer of the merchant;
an issuer that has issued an account to the consumer;
30 a transaction handler; and
any combination thereof.

10. The apparatus as defined in Exemplary Implementation No. 9 wherein the computer readable medium further comprises stored instructions that, when executed by the

computing device, the computing device performs the step of receiving a confirmation that the at least one of the announcement recipients has received the announcement.

11. The apparatus as defined in Exemplary Implementation No. 9 wherein the computer readable medium further comprises stored instructions that, when executed by the
5 computing device, the computing device performs the steps of:

specifying a selected set of the announcement recipients;

receiving information usable to determine the zone of interest to each of the announcement recipients in the selected set;

and

10 determining when the announcement condition has been satisfied including matching the determined location of the apparatus with the zones of interest of the at least one of the announcement recipient in the selected set, wherein the transmission also indicates that the announcement condition has been satisfied.

12. The apparatus as defined in Exemplary Implementation No. 9 wherein the
15 location of the apparatus includes at least one of:

an altitude of the apparatus;

a latitude location of the apparatus;

a longitude of the apparatus;

a World Geodetic System coordinates of the apparatus;

20 a speed of the apparatus;

a direction of movement of the apparatus;

an acceleration of the apparatus; and

a combination thereof.

13. The apparatus as defined in Exemplary Implementation No. 9 wherein the
25 apparatus is a portable consumer device selected from the group consisting of:

a financial card;

a contactless device including a wireless processor, a transmitter, and a receiver;

a smart card;

a cellular telephone;

30 a personal digital assistant;

a digital audio player;

a global positioning system enabled device;

a computer; and

a combination of any of the above portable consumer devices.

14. The apparatus as defined in Exemplary Implementation No. 9 wherein the transmission is wirelessly communicated to at least one of:

a point of interaction terminal that is co-located with the apparatus;

a portable consumer device co-located with the apparatus;

5 a near field communication terminal that is co-located with the apparatus; and

a far field communication terminal that is co-located with the apparatus.

15. A computer implemented method for auctioning an announcement about a consumer to a plurality of auction participants, the computer implemented method comprising the steps of:

10 consenting, using a portable consumer device executing software, to an auctioning of the announcement, wherein the plurality of auction participants electronically bid on receiving data about the consumer that is co-located with the portable consumer device within a zone;

providing, using the portable consumer device executing the software, information usable to determine when the portable consumer device is in the zone;

15 and

receiving, using the portable consumer device executing the software, a communication addressed from at least one of the auction participants that has a winning bid in the auction, wherein the receiving occurs while the portable consumer device is in the zone.

16. The computer implemented method as defined in Exemplary Implementation No. 20 15 further comprising the step of specifying, using the portable consumer device executing the software, at least one required criterion for the winning bid.

17. The computer implemented method as defined in Exemplary Implementation No. 15 further comprising the step of specifying, using the portable consumer device executing the software, the at least one specified condition.

25 18. The computer implemented method as defined in Exemplary Implementation No. 17 wherein the portable consumer device is selected from the group consisting of:

a contactless device including a wireless processor, a transmitter, and a receiver;

a smart card;

a cellular telephone;

30 a personal digital assistant;

a digital audio player;

a portable global positioning system enabled device;

and

a combination of any of the above portable consumer devices.

19. The computer implemented method as defined in Exemplary Implementation No. 15 wherein the step of the providing the information includes providing, to a merchant, an account identifier of an account issued to the consumer by an issuer within a payment processing system, wherein the account identifier is sent within a payment authorization request from a
5 point of interaction terminal that is co-located with the portable consumer device.

20. The computer implemented method as defined in Exemplary Implementation No. 15 wherein at least one of the plurality of auction participants is selected from the group consisting of:

a merchant;

10 an acquirer of the merchant;

an issuer that has issued an account to the consumer;

a transaction handler; and

any combination thereof and, wherein:

15 the transaction handler processes a plurality of transactions each between a corresponding said merchant and a corresponding said consumer;

each transaction is upon a corresponding said account of one of the consumers;

each of the merchants submits transactions to corresponding said acquirers for processing by the transaction handler who requests corresponding said issuers to obtain corresponding payments from corresponding said accounts for the submitted said

20 transactions; and

the corresponding said issuers forward the obtained said corresponding payments to the corresponding said acquirers to pay the submitting said merchants for corresponding submitted said transactions.

25 **Exemplary implementations corresponding to US Patent Application Serial No. 12/428,324, filed on April 22, 2009, titled "Bidding To Receive Data After A Consumer Is In A Zone," as Attorney Docket No. P-14249US (930676.00117):**

1. A computer implemented method for electronically participating in an auction for
30 an announcement including data about at least one consumer, the computer implemented method comprising the steps of:

bidding, using a computing apparatus executing software, to receive the announcement after at least one criterion of an announcement condition is satisfied including presence of the at least one consumer within a zone;

receiving, using the computing apparatus executing the software, notification that the bid to receive the announcement is a winning bid; and

receiving, using the computing apparatus executing the software, the announcement after the announcement condition is satisfied.

5 2. The computer implemented method as defined in Exemplary Implementation No. 1 further comprising the step of receiving, using the computing apparatus executing the software, an auction initiation communication indicating that the auction has begun.

 3. The computer implemented method as defined in Exemplary Implementation No. 1 further comprising the step of forming, using the computing apparatus executing the software,
10 a first transmission including information usable to:

 determining a location of a first said consumer;

 match the first said consumer with the at least one consumer; and

 comparing the location of the first said consumer to the zone.

 4. The computer implemented method as defined in Exemplary Implementation No.
15 3 wherein:

 the first said consumer is associated with an account that is issued by a corresponding issuer within a payment processing system;

 a first said criterion is satisfied after the first said consumer is matched with the at least one consumer;

20 a second said criterion is satisfied after the location is matched with the zone;

 and

 a third said criterion is satisfied after there is a match of at least one of:

 an account characteristic of the account with a required account characteristic;

25 a transaction history of the account with a required tendency to purchase a specific type of resource; and

 a demographic of the first said consumer with a required demographic, wherein the demographic is associated with the account within the payment processing system.

30 5. The computer implemented method as defined in Exemplary Implementation No. 3 further comprising receiving, using the computing apparatus executing the software, a second transmission including data from a portable consumer device that is co-located with the first said consumer, wherein a portion of the received data is included in the first transmission.

6. The computer implemented method as defined in Exemplary Implementation No. 5 wherein the portable consumer device is selected from the group consisting of:

- a financial card;
- a contactless device including a wireless processor, a transmitter, and a receiver;
- 5 a smart card;
- a cellular telephone;
- a personal digital assistant;
- a digital audio player;
- a global positioning system enabled device;
- 10 a computer; and
- a combination of any of the above portable consumer devices.

7. The computer implemented method as defined in Exemplary Implementation No. 1 further comprising the step of using the computing apparatus executing the software to specify the at least one criterion that can be matched to the received data.

15 8. The computer implemented method as defined in Exemplary Implementation No. 1 wherein the auction is of a type selected from the group consisting of:

- English auction;
- Dutch auction;
- sealed-bid first-price auction;
- 20 sealed-bid second-price auction;
- supply auction;
- demand auction;
- double auction;
- open auction;
- 25 closed auction;
- buyout auction;
- raffle; and
- combinations of any of the above types of auctions.

9. The computer implemented method as defined in Exemplary Implementation No. 30 1 wherein:

each of the steps of the computer implemented method is performed by a merchant within a payment processing system that includes a transaction handler processing a plurality of transactions between the merchant and a plurality of said consumers that have each been issued a corresponding account by a corresponding issuer within the payment processing system;

the merchant submits a corresponding said transaction to a corresponding acquirer for processing by the transaction handler who requests the corresponding issuer to obtain payment for the corresponding said transaction from the corresponding account; and

the issuer forwards the obtained said payment to the corresponding acquirer to pay the merchant for the corresponding said transaction.

10. The computer implemented method as defined in Exemplary Implementation No. 1 wherein the at least one criterion includes electronically receiving a transaction occurring:
within a specified time interval;
with a merchant located in the zone; and
upon a payment account issued to the at least one consumer by an issuer within a payment processing system.

11. An apparatus comprising a computer readable medium including stored instructions that, when executed by a computing device, the computing device perform the steps of:

bidding for an option to receive data that is conducive to communicating with at least one consumer after at least one announcement condition occurs including presence of the at least one consumer within a spatial zone; and

after the announcement condition occurs and the bid is a winning bid, receiving the data conducive to communicating with at least one consumer located within the spatial zone.

12. The apparatus as defined in Exemplary Implementation No. 11 wherein the computer readable medium further comprises stored instructions that, when executed by the computing device, the computing device performs the step of forming a transmission including information received from a portable consumer device that is co-located with a first said consumer, wherein the information is usable to:

determining a location of the first said consumer;
match the first said consumer with the at least one consumer; and
comparing the location of the first said consumer to the spatial zone.

13. The apparatus as defined in Exemplary Implementation No. 12 wherein the information that is usable to determine the location of the first said consumer includes at least one of:

a merchant identification code associated with a merchant having a known location;
an altitude of the portable consumer device;
a latitude of the portable consumer device;
a longitude of the portable consumer device;

a World Geodetic System coordinates of the portable consumer device;
data usable to determine a direction of movement of the portable consumer device; and
data usable to determine a speed of the portable consumer device.

14. A computer implemented method for participating in an auction for an option to
5 receive data that is conducive to communicating with at least one consumer when the consumer
is located in a zone, the computer implemented method comprising the steps of:

forming, using a computing apparatus executing software, a first electronic transmission,
addressed to an auctioneer of the option, including:

10 a merchant indicator usable to determine a merchant return address of a
corresponding merchant; and

an announcement condition for forming a bid for the option including presence of
the least one consumer within the zone;

when the announcement condition is satisfied, forming, using the computing apparatus
executing the software, the bid for the option, wherein the bid is addressed to the auctioneer;

15 and

when the bid is a winning bid, receiving at the return address, using the computing
apparatus executing the software, the data that is conducive to communicating with the least one
consumer within the zone.

15. The computer implemented method as defined in Exemplary Implementation No.
20 14, further comprising the step of enabling, using the computing apparatus executing the
software, a communication to a portable consumer device co-located with the least one consumer
within the zone.

16. The computer implemented method as defined in Exemplary Implementation No.
15 wherein the step of enabling the communication includes forming, using the computing
25 apparatus executing the software, a transmission addressed to the portable consumer device and
including a message from the corresponding merchant.

17. The computer implemented method as defined in Exemplary Implementation No.
15 wherein the communication to the portable consumer device includes indicia of a discount
that the consumer can receive when:

30 the consumer engages in a transaction upon an account issued to the consumer by an
issuer within a payment processing system; and

the transaction is conducted at a point of interaction terminal of the corresponding
merchant located in the zone.

18. The computer implemented method as defined in Exemplary Implementation No. 14, further comprising the steps of:

receiving, using the computing apparatus executing the software, information from a portable consumer device that is co-located with a first said consumer; and

5 prior to the forming the bid, forming, using the computing apparatus executing the software, a transmission addressed to the auctioneer, wherein the transmission includes the merchant indicator and the information received from the portable consumer device.

19. The computer implemented method as defined in Exemplary Implementation No. 14 wherein the announcement condition further includes a criterion that is selected from the group consisting of:

10 a window of time for receiving the data conducive to communicating with the at least one consumer;

an account category of an account of the at least one consumer issued to the at least one consumer by an issuer within a payment processing system;

15 a transaction history of the account indicating a tendency to purchase resources matching that of the corresponding merchant;

a demographic of the at least one consumer;

an occurrence of a transaction upon the account while the at least one consumer has been in the zone; and

20 a combination thereof.

20. The computer implemented method as defined in Exemplary Implementation No. 14 further comprising the step of using the computing apparatus executing the software to repeat the step of forming the bid successively until at least one of the formed successive bids is the winning bid.

25

Exemplary implementations corresponding to US Patent Application Serial No. 12/428,262, filed on April 22, 2009, titled "Auctioning of Announcements," as Attorney Docket No. P-14246US (930676.00114):

30 1. A computer implemented method for auctioning, to a plurality of auction participants, options to communicate with consumers, the computer implemented method comprising the steps of:

performing, using a computing apparatus executing software, an auction, wherein:

the plurality of auction participants each bid for the option to communicate, after at least one specified condition occurs, with at least one said consumer;

the at least one of the specified condition includes presence of the at least one said consumer in a first zone; and

5 at least one said auction participant has a winning bid;

and

after the at least one specified condition occurs, facilitating, using the computing apparatus executing the software, a communication to the at least one said consumer from the at least one said auction participant that has the winning bid.

10 2. The computer implemented method as defined in Exemplary Implementation No. 1 wherein the step of performing the auction includes:

electronically transmitting, using the computing apparatus executing the software, an auction notification to the plurality of auction participants; and

15 receiving, using the computing apparatus executing the software, a corresponding electronic bid from at least one of the auction participants.

3. The computer implemented method as defined in Exemplary Implementation No. 1 further comprising the step of determining, using the computing apparatus executing the software, whether the at least one specified condition has occurred including:

establishing a location of the at least one said consumer; and

20 comparing the established location with the first zone to find a match.

4. The computer implemented method as defined in Exemplary Implementation No. 3, further comprising receiving, using the computing apparatus executing the software, an authorization request for a transaction upon a payment account associated with the at least one said consumer, wherein:

25 the authorization request is addressed from a point of interaction terminal of a corresponding said merchant that is co-located with the at least one said consumer when the authorization request is received; and

the establishing of the location of the at least one said consumer includes, using a code in the authorization request to determine the location.

30 5. The computer implemented method as defined in Exemplary Implementation No. 3 further comprising the step of receiving, using the computing apparatus executing the software, an electronic transmission including information usable to establish the location of the at least one said consumer, wherein the transmission is addressed from at least one of the following:

a portable consumer device of the at least one said consumer;

a point of interaction terminal that is co-located with the at least one said consumer;
a near field communication terminal that is co-located with the at least one said
consumer; and

a far field communication terminal that is co-located with the at least one said consumer.

5 6. The computer implemented method as defined in Exemplary Implementation No. 1 wherein the step of facilitating the communication includes electronically transmitting, using the computing apparatus executing the software, an announcement about the at least one said consumer to the at least one said auction participant with the winning bid.

10 7. The computer implemented method as defined in Exemplary Implementation No. 1 wherein:

each said bid has a corresponding monetary offer for the option to communicate with the at least one said consumer; and

the winning bid satisfies a winning criterion that is selected from the group consisting of:

receiving a corresponding said bid within a specified window of time;

15 a highest said monetary offer among the corresponding monetary offers of the each said bid; and

a combination of the above winning criteria.

20 8. The computer implemented method as defined in Exemplary Implementation No. 1 further comprising the step of determining, using the computing apparatus executing the software, when the at least one specified condition occurs, including:

receiving data addressed from a portable consumer device co-located with a first said consumer;

using the received data to:

match the first consumer to the at least one said consumer; and

25 determine a location of the first said consumer;

and

matching the determined location of the first said consumer with the first zone.

30 9. The computer implemented method as defined in Exemplary Implementation No. 8 wherein:

the first said consumer is associated with a payment account that is issued by a corresponding issuer within a payment processing system;

account information associated with the account is stored in a database within the payment processing system;

the determining when the at least one specified condition occurs further includes using

the received data to find a match between the corresponding said account information with at least one of:

a required account characteristic;

a required tendency to purchase a specific type of resource; and

5 a required demographic, wherein the corresponding said account information includes a corresponding demographic of the first said consumer.

10. The computer implemented method as defined in Exemplary Implementation No. 1 wherein the auction is of a type selected from the group consisting of:

English auction;

10 Dutch auction;

sealed-bid first-price auction;

sealed-bid second-price auction;

supply auction;

demand auction;

15 double auction;

open auction;

closed auction;

buyout auction;

raffle; and

20 combinations of any of the above types of auctions.

11. The computer implemented method as defined in Exemplary Implementation No. 1 wherein:

there are a plurality of types of the auction participants; and

25 for each of the plurality of types, at least one of the corresponding auction participants is awarded one of the winning bids.

12. The computer implemented method as defined in Exemplary Implementation No. 1 wherein each of the plurality of auction participants is selected from the group consisting of:

a merchant;

an acquirer of the merchant;

30 an issuer that has issued an account to the at least one consumer;

a transaction handler; and

any combination thereof, wherein:

the transaction handler processes a plurality of transactions each between a corresponding said merchant and a corresponding said consumer;

each transaction is upon a corresponding account of a corresponding said consumer;

each of the merchants submits a corresponding said transaction to a corresponding said acquirer for processing by the transaction handler who requests a corresponding said issuer to obtain payment for the corresponding said transaction from a corresponding said account; and

the corresponding said issuer forwards the obtained payment to the corresponding said acquirer to pay the corresponding said merchant for the corresponding said transaction.

13. A computer implemented method for auctioning an announcement about a consumer to a plurality of auction participants, the computer implemented method comprising the steps of:

performing, using a computing apparatus executing software, an electronic auction, wherein:

a plurality of auction participants each electronically bid on receiving the announcement after at least one announcement condition occurs;

the at least one announcement condition includes presence of the consumer within a spatial zone; and

at least one auction participant has a winning bid;

determining, using the computing apparatus executing the software, when the at least one announcement condition occurs;

and

after the at least one announcement condition occurs, forming, using the computing apparatus executing the software, the announcement for electronic delivery to the at least one auction participant that has the winning bid while the consumer is within the spatial zone.

14. The computer implemented method as defined in Exemplary Implementation No. 13 further comprising the step of transmitting, using the computing apparatus executing the software, an auction initiating communication to the plurality of auction participants:

after the at least one announcement condition occurs; and

before the step of performing the electronic auction.

15. The computer implemented method as defined in Exemplary Implementation No. 14 wherein the announcement condition includes receipt of a transaction of the consumer upon a payment account issued to the consumer by an issuer within a payment processing system.

16. An apparatus comprising a computer readable medium including stored instructions that, when executed by a computing apparatus, the computing apparatus performs the steps of:

specifying conditions for performing an electronic auction, wherein the specified
5 conditions include presence of a portable consumer device of a corresponding consumer within a spatial zone; and

performing an electronic auction, wherein a plurality of auction participants electronically bid for an option to communicate with the portable consumer device within the spatial zone;

10 determining when the announcement conditions occur;

and

after the announcement conditions occur, enabling a communication with the portable consumer device within the spatial zone from at least one of the auction participants having a corresponding winning said bid.

15 17. The apparatus as defined in Exemplary Implementation No. 16 wherein the computer readable medium further comprises stored instructions that, when executed by the computing apparatus, the computing apparatus performs the step of receiving an authorization request for a transaction upon a payment account of the corresponding consumer, wherein:

the authorization request is addressed from a point of interaction terminal of a
20 corresponding merchant that is co-located with the portable consumer device when the authorization request is received; and

the determining when the announcement conditions occur includes:

using a code in the authorization request to determine a location of the portable
consumer device; and

25 comparing the determined location to the spatial zone to find a match.

18. The apparatus as defined in Exemplary Implementation No. 16 wherein the portable consumer device is selected from the group consisting of:

a financial card;

a contactless device including a wireless processor, a transmitter, and a receiver;

30 a smart card;

a cellular telephone;

a personal digital assistant;

a digital audio player;

a global positioning system enabled device;

a computer; and

a combination of any of the above portable consumer devices.

19. The apparatus as defined in Exemplary Implementation No. 16 wherein:
the step of determining when the announcement conditions occur includes:

5 receiving a location data, transmitted from the portable consumer device, usable
to identify a location of the portable consumer device;

using the received location data to determine the location of the portable
consumer device; and

10 comparing the determined said location of the portable consumer device with the
spatial zone to find a match.

20. The apparatus as defined in Exemplary Implementation No. 19 wherein the
location data includes at least one of:

a merchant identification code associated with a merchant having a known location;

an altitude of the portable consumer device;

15 a latitude of the portable consumer device;

a longitude of the portable consumer device;

a World Geodetic System coordinates of the portable consumer device;

data usable to determine a direction of movement of the portable consumer device; and

data usable to determine a speed of the portable consumer device.

20

**Exemplary implementations corresponding to US Patent Application Serial No.
12/428,398, filed on April 22, 2009, titled "Providing An Announcement About
Transactions Of A Target Merchant To A Consumer," as Attorney Docket No. P-14250US
(930676.00118):**

25

1. A computer implemented method comprising a plurality of steps each being
performed using a computing apparatus executing software, the steps including:

receiving transaction data for each of a plurality of transactions for resources of any of a
plurality of merchants within a payment processing system, wherein:

30 each said transaction is conducted on an account issued to a corresponding said
consumer that is processed for payment to a corresponding said merchant; and

the transaction data for the each said transaction includes an indicator usable to
distinguish the corresponding said merchant engaged in the each said transaction;

receiving a query of a first said consumer:

- requesting an announcement about at least one said transaction of a target said merchant with one said consumer that is different from the first said consumer; and including data usable to determine the indicator of the target said merchant; using the data included in the query to determine the indicator of the target said merchant;
- 5 merchant;
- distinguishing the at least one said transaction of the target said merchant from among the plurality of said transactions by finding at least one match between the determined said indicator of the target said merchant with the indicator included in the received transaction data; and
- 10 forming the announcement including information based on the transaction data of the distinguished at least one said transaction, wherein the announcement is for delivery to the first said consumer.
2. The computer implemented method as defined in Exemplary Implementation No. 1, wherein the query is received while the first said consumer is present within a zone that
- 15 includes a location of the target said merchant.
3. The computer implemented method as defined in Exemplary Implementation No. 2, wherein the zone is selected from the group consisting of:
- a spatial zone;
- an Internet zone;
- 20 a virtual zone; and
- a combination of any of the above zones.
4. The computer implemented method as defined in Exemplary Implementation No. 1, wherein the target said merchant is selected from the group consisting of:
- one said merchant that is identified in the query by the first said consumer; and
- 25 one said merchant that is:
- unidentified in the query by the first said consumer; and
- located within a zone that is identified in the query by the first said consumer.
5. The computer implemented method as defined in Exemplary Implementation No. 1, wherein the information included in the announcement is selected from the group consisting
- 30 of:
- data about a price paid for one said resource in the distinguished at least one said transaction of the target said merchant;

a confirmation that a current advertised said price for the one said resource of the target said merchant is less than the price paid in the distinguished at least one said transaction of the target said merchant;

an indication of a return, to the target said merchant, of the one said resource purchased in the distinguished at least one said transaction of the target said merchant;

an indication of an incentive provided, under a loyalty program, to a corresponding said consumer engaged in the distinguished at least one said transaction of the target said merchant;

an indication of a quantity of the distinguished at least one said transaction of the target said merchant; and

a combination of any of the above information.

6. The computer implemented method as defined in Exemplary Implementation No. 1, wherein the steps further comprise, subsequent to the step of forming the announcement, receiving a transmission including a communication from the first said consumer for delivery to the target said merchant.

7. The computer implemented method as defined in Exemplary Implementation No. 6, wherein the communication includes an offer from the first said consumer to purchase a corresponding said resource previously sold in the distinguished at least one said transaction of the target said merchant, wherein:

the corresponding said resource was previously sold at a previous price; and

the offer is to purchase the corresponding said resource at the previous price.

8. The computer implemented method as defined in Exemplary Implementation No. 7, further comprising the step of receiving an authorization request for one said transaction between the target said merchant and the first said consumer for the corresponding said resource at the previous price.

9. An apparatus comprising a computer readable medium including stored instructions that, when executed by a computing apparatus, the computing apparatus performs the steps of:

receiving data about a plurality of transactions each between a corresponding merchant and a corresponding consumer for corresponding resources, wherein the data about each said transaction includes an indicator usable to distinguish the each said transaction as occurring with a corresponding said merchant;

receiving a query of a first said consumer requesting an announcement about at least one said transaction of at last one target said merchant located within a spatial zone, wherein the spatial zone is specified by the first said consumer;

using a corresponding said indicator of the at least one target said merchant to distinguish the at least one said transaction of the at least one target said merchant; and

forming the announcement, responsive to the query:

including information based on the transaction data of the distinguished said at least one said transaction; and

for delivery to a portable consumer device that is co-located with the first said consumer.

10. The apparatus as defined in Exemplary Implementation No. 9, wherein:

the spatial zone is delineated by at least one specified distance relative to a position of the portable consumer device; and

the computer readable medium further comprises stored instructions that, when executed by the computing apparatus, the computing apparatus performs the steps of:

receiving a transmission including information usable to determine a position of the portable consumer device;

using at least the information included in the transmission to determine the position of the portable consumer device;

determining a location of each of a plurality of said merchants relative to the determined position of the portable consumer device; and

identifying the at least one target said merchant by:

comparing the relative locations of the each of the plurality of said merchants to the at least one specified distance to find a match;

and

determining the corresponding indicators of each of the at least one target said merchant.

11. The apparatus as defined in Exemplary Implementation No. 9, wherein the information includes at least one of:

data about a price paid for one said resource in the distinguished at least one said transaction;

a confirmation that a current advertised said price for the one said resource of the at least one target said merchant is less than the price paid in the distinguished at least one said transaction;

an indication of a return, to the at least one target said merchant, of the one said resource purchased in the distinguished at least one said transaction;

an indication of an incentive provided, under a loyalty program, to a corresponding said consumer engaged in the distinguished at least one said transaction;

an indication of a quantity of the distinguished at least one said transaction; and

a combination of any of the above.

5 12. The apparatus as defined in Exemplary Implementation No. 9, wherein the portable consumer device is selected from the group consisting of:

a financial card;

a contactless device including a wireless processor, a transmitter, and a receiver;

a smart card;

10 a cellular telephone;

a personal digital assistant;

a digital audio player;

a global positioning system enabled device;

a computer; and

15 a combination of any of the above portable consumer devices.

13. The apparatus as defined in Exemplary Implementation No. 9, wherein:

a transaction handler within the payment processing system processes the plurality of said transactions;

20 each said transaction is conducted upon a corresponding account of a corresponding said consumer;

each said merchant submits a corresponding said transaction to a corresponding acquirer for processing by the transaction handler who requests a corresponding issuer to obtain a corresponding payment for the submitted transaction from a corresponding said account issued to a corresponding said member consumer by the corresponding said issuer; and

25 the corresponding said issuer forwards the obtained corresponding payment to the corresponding acquirer to pay the submitting said merchant for the submitted said transaction.

14. The apparatus as defined in Exemplary Implementation No. 9, wherein the computer readable medium further comprises stored instructions that, when executed by the computing apparatus, the computing apparatus performs the step of, subsequent to the step of forming the announcement, receiving a transmission including a communication from the first
30 said consumer for delivery to the at least one target said merchant.

15. A computer implemented method comprising a plurality of steps each being performed using a computing apparatus executing software, the steps including:

in a payment processing system which notifies a consumer of at least one transaction for resources between any of a plurality of merchants and any of a plurality of consumers, wherein each said transaction is conducted on an account issued to a corresponding consumer that is processed for payment to a corresponding said merchant:

5 receiving a query addressed from a shopper requesting data about at least one said transaction of a target said merchant, wherein the target said merchant is associated with an indicator usable to distinguish the at least one said transaction of the target said merchant from among other said transactions;

 using the indicator to distinguish the at least one said transaction of the target said merchant from among the other said transactions;

10 and

 forming an announcement:

 including the data about the distinguished at least one said transaction of the target said merchant; and

15 for delivery to the shopper.

16. The computer implemented method as defined in Exemplary Implementation No. 15, wherein the announcement further includes a merchant offer for a future said transaction for one said resource previously sold in the distinguished at least one said transaction.

17. The computer implemented method as defined in Exemplary Implementation No. 20 16, wherein the merchant offer includes a discounted price for the at least one said resource, wherein the discounted price is lower than a price at which the at least one said resource was sold in the distinguished at least one said transaction.

18. The computer implemented method as defined in Exemplary Implementation No. 15, wherein the steps further comprise, subsequent to the shopper receiving the announcement, 25 receiving a transmission including a communication from the shopper for delivery to the target said merchant.

19. The computer implemented method as defined in Exemplary Implementation No. 15, wherein the steps further comprise receiving a plurality of said transactions, wherein:

 a transaction handler processes the plurality of said transactions;

30 each of the merchants submits corresponding said transactions to a corresponding said acquirer for processing by the transaction handler who requests corresponding issuers of the corresponding said accounts to obtain corresponding payments for the submitted corresponding said transactions from the corresponding accounts; and

the corresponding issuers forward the obtained corresponding payments for delivery to the corresponding acquirers to pay the submitting said merchant for the submitted said transactions.

20. The computer implemented method as defined in Exemplary Implementation No. 5 15, wherein the data includes at least one of:

data about a price paid for one said resource in the distinguished at least one said transaction;

a confirmation that a current advertised said price for the one said resource of the at least one target said merchant is less than the price paid in the distinguished at least one said 10 transaction;

an indication of a return, to the at least one target said merchant, of the one said resource purchased in the distinguished at least one said transaction;

an indication of an incentive provided, under a loyalty program, to a corresponding said consumer engaged in the distinguished at least one said transaction;

15 an indication of a quantity of the distinguished at least one said transaction; and
a combination of any of the above.

Exemplary implementations corresponding to US Patent Application Serial No. 12/428,241, filed on April 22, 2009, titled "Targeting Merchant Announcements Triggered 20 by Consumer Activity Relative to a Surrogate Merchant," as Attorney Docket No. P-14245US (930676.00113):

1. A computer implemented method for providing an announcement to a consumer and comprising the steps of:

25 electronically receiving, using a computing apparatus executing software:

a request from a targeting merchant to transmit an announcement to the consumer after an announcement condition has been satisfied; and

a plurality of transactions each:

30 being conducted by the consumer with a surrogate merchant; and
containing transaction information that includes a surrogate merchant
identifier usable to identify the surrogate merchant conducting the transaction;

electronically determining, using the computing apparatus executing the software,
whether the announcement condition has been satisfied by the surrogate merchant identifier in

the transaction information for one said transaction corresponding to a specific said surrogate merchant; and

electronically transmitting using the computing apparatus executing the software, in temporal proximity after the satisfaction of the announcement condition, an electronic transmission including the announcement from the targeting merchant for delivery to the consumer.

2. The computing apparatus implemented method as defined in Exemplary Implementation No. 1, wherein, for each said transaction, both the transaction information and an authorization request are received in one or more electronic transmissions addressed from a point of interaction terminal of the corresponding said surrogate merchant that is also co-located with the consumer.

3. The computer implemented method as defined in Exemplary Implementation No. 1, wherein:

the transaction information is received while the corresponding said transaction is being processed within a payment processing system; and

the announcement includes at least a portion of the transaction information for the transaction satisfying the announcement condition.

4. The computer implemented method as defined in Exemplary Implementation No. 1, wherein the satisfaction of the announcement condition further includes determining that the specific surrogate merchant is a competitor of the targeting merchant by:

determining that the merchant identifier of the specific said surrogate merchant corresponds to a first category;

determining that the merchant identifier of the targeting merchant corresponds to a second category; and

determining that the first category matches the second category.

5. The computer implemented method as defined in Exemplary Implementation No. 1, wherein the electronic transmission that includes the announcement from the targeting merchant the delivery to the consumer is addressed to at least one of:

a portable consumer device associated with the consumer; and

a point of interaction terminal of the specific surrogate merchant that is co-located with the consumer.

6. The computer implemented method as defined in Exemplary Implementation No. 1, wherein:

prior to the satisfaction of the announcement condition, the electronically received said transactions include:

a first said transaction conducted by the consumer with the specific said surrogate merchant; and

5 a chronologically sequential second said transaction conducted by the consumer with the target merchant occurring after the first said transaction; and

the temporal proximity after the satisfaction of the announcement condition is less than or equal to the length of time between the first said transaction and the second said transaction.

10 7. The computer implemented method as defined in Exemplary Implementation No. 1 wherein:

transaction handlers process the plurality of transactions upon corresponding accounts within at least one payment processing system;

15 each of the surrogate merchants submits corresponding said transactions to corresponding acquirers for processing by corresponding said transaction handlers who request corresponding issuers of the corresponding said accounts to obtain corresponding payments for the corresponding said transactions from the corresponding said accounts; and

the corresponding said issuers forward each of the obtained corresponding payments for delivery to the corresponding said acquirers to pay the submitting said surrogate merchant for the submitted said transactions.

20 8. The computer implemented method as defined in Exemplary Implementation No. 1 further comprising, after the step of transmitting the electronic transmission, electronically receiving, using the computing apparatus executing the software, an authorization request for another said transaction between the targeting merchant and the consumer.

25 9. The computer implemented method as defined in Exemplary Implementation No. 1 further comprises the step of, after the step of transmitting the electronic transmission, receiving, using the computing apparatus executing the software, a communication of the consumer for delivery to the targeting merchant.

30 10. The computer implemented method as defined in Exemplary Implementation No. 9 wherein:

the announcement is an offer to the consumer for a resource of the targeting merchant; and

the communication is an acceptance of the offer by the consumer.

11. A computer implemented method for providing an announcement of a targeting merchant to a consumer, the computer implemented method comprising the steps of:

electronically receiving, using a computing apparatus executing software:

transaction information for a plurality of transactions of a plurality of surrogate
5 merchants upon an account of the consumer, wherein the plurality of transactions
include:

a first said transaction of a specific said surrogate merchant upon the
account; and

a second said transaction of the targeting merchant upon the account;

10 and

an announcement condition that includes:

an occurrence of a third said transaction of the specific surrogate merchant
upon the account that occurs subsequent to the second said transaction; and

the electronic receipt of the third said transaction by the computing
15 apparatus executing software;

and

electronically transmitting using the computing apparatus executing the software, after
the announcement condition is satisfied, a transmission including the announcement of the
targeting merchant addressed for delivery to a portable consumer device of the consumer.

20 12. The computer implemented method as defined in Exemplary Implementation No.
11 further comprising the step of determining, using the computing apparatus executing the
software, a window of time between the first said transaction and the second said transaction,
wherein the announcement is transmitted within the window of time after the third said
transaction.

25 13. The computer implemented method as defined in Exemplary Implementation No.
12 further comprising the steps of, within the window of time after the third said transaction,
electronically receiving, using the computing apparatus executing the software, an authorization
request for another said transaction of the targeting merchant upon the account.

30 14. The computer implemented method as defined in Exemplary Implementation No.
11 further comprising the step of, after the step of transmitting the transmission, electronically
receiving, using the computing apparatus executing the software, an acceptance by the consumer
of an offer of the targeting merchant, wherein the offer is included in the announcement and the
received acceptance is addressed from the portable consumer device.

15. The computer implemented method as defined in Exemplary Implementation No. 11 wherein:

a transaction handler processes each of the transactions of each of the surrogate merchants upon the account;

5 each of the surrogate merchants submits the corresponding said transactions to a corresponding acquirer for processing by the transaction handler who requests a corresponding issuer of the account to obtain corresponding payments for the corresponding said transactions from the account; and

10 the corresponding issuer forwards the obtained corresponding payments for delivery to the corresponding acquirer to pay the submitting said surrogate merchant for the submitted said transactions.

16. The computer implemented method as defined in Exemplary Implementation No. 11 wherein the portable consumer device is selected from the group consisting of:

a financial card;

15 a contactless device including a wireless processor, a transmitter, and a receiver;

a smart card;

a cellular telephone;

a personal digital assistant;

a digital audio player;

20 a global positioning system enabled device;

a portable computing apparatus; and

a combination of the foregoing.

17. An apparatus comprising a computer readable medium including stored instructions that, when executed by a computing apparatus, the computing apparatus performs 25 the steps of:

electronically receiving a plurality of transactions conducted upon accounts of consumers with:

a surrogate merchant; and

a targeting merchant;

30 electronically determining, for each said consumer, a time interval between each pair of chronologically sequential said transactions conducted with:

the surrogate merchant; and

the targeting merchant;

electronically receiving location data useable to detect the location of a specific said consumer;

and

upon detecting from the location data that the location of the specific said consumer is within a spatial zone proximal a location of the surrogate merchant, electronically transmitting, between the minimum said time interval and the maximum said time interval, an announcement making an offer to the specific said consumer to conduct one said transaction with the targeting merchant.

18. The apparatus as defined in Exemplary Implementation No. 17, wherein transmitted said announcement is addressed for delivery to at least one of:

a point of service terminal of the surrogate merchant; and

a portable consumer device co-located with the specific said consumer.

19. The as defined in Exemplary Implementation No. 17, wherein the computer readable medium further comprises stored instructions that, when executed by the computing apparatus, the computing apparatus, after said detecting, electronically receives an authorization request for another said transaction conducted by the specific said consumer with the targeting merchant and the first said consumer.

Exemplary implementations corresponding to US Patent Application Serial No. 12/428,364, filed on April 22, 2009, titled "Notification of Resources of Interest To Members Of A Consumer Group," as Attorney Docket No. P-14245US1 (930676.00208):

1. A computer implemented method comprising a plurality of steps each being performed using a computing apparatus executing software, the steps including:

in a payment processing system which notifies a member consumer of at least one transaction for resources between any of a plurality of merchants and any said member consumer in a consumer group, wherein each said transaction is conducted on an account issued to one said member consumer that is processed for payment to the one said merchant:

receiving resource data identifying a resource set including resources of interest to at least one of the member consumers in the consumer group;

receiving transaction data for the at least one transaction, wherein the transaction data includes information about a corresponding said resource;

finding a matching resource by a comparison of the resources of interest in the resource set with the corresponding said resource in the received transaction data for the at least one transaction;

and

5 for each said matching resource, sending a transmission including data about the matching resource for delivery to at least one of the member consumer in the consumer group.

2. The computer implemented method as defined in Exemplary Implementation No. 1, wherein the steps further comprise updating the resource set by removing each said matching
10 resources from the resources of interest in the resource set.

3. The computer implemented method as defined in Exemplary Implementation No. 1, wherein the transmission includes at least one of:

a purchase price of the matching resource;
a time that the matching resource was purchased in the at least one transaction;
15 a name of the member consumer that purchased the matched said resource;
a date the matching resource was purchased;
a resource identifier of the matching resource;
a manufacturer identifier of the matching resource; and
a message from one of the member consumers.

20 4. The computer implemented method as defined in Exemplary Implementation No. 1, wherein:

the transmission includes a merchant offer for a future said transaction for the matching resource at a discount price; and
the discount price matches a price previously paid by one said member consumer for the
25 matching resource purchased in the at least one transaction.

5. The computer implemented method as defined in Exemplary Implementation No. 1, wherein the steps further comprise:

obtaining target information including position data usable to determine a position of one
of the member consumers;
30 using the position data to determine the position of the one of the member consumers;
comparing the position to a zone to identify a match, wherein:
a targeting merchant is located in the zone; and
the targeting merchant is capable of engaging in a future said transaction for at
least one of the resources of interest in the resource set;

and

forming an announcement for delivery to at least one of:

the one of the member consumers located in the zone; and

the targeting merchant.

5 6. The computer implemented method as defined in Exemplary Implementation No. 5, wherein the announcement includes at least one of:

data about the one of the member consumers located in the zone;

data about the resource set; and

data about the targeting merchant.

10 7. The computer implemented method as defined in Exemplary Implementation No. 5, wherein:

the target information includes data from a portable consumer device of the one of the member consumers; and

the portable consumer device is selected from the group consisting of:

15 a financial card;

a contactless device including a wireless processor, a transmitter, and a receiver;

a smart card;

a cellular telephone;

a personal digital assistant;

20 a digital audio player;

a global positioning system enabled device;

a portable computing apparatus; and

a combination of the foregoing.

 8. The computer implemented method as defined in Exemplary Implementation No. 25 1, wherein the steps further comprise receiving, in a transmission addressed from one of the member consumers, an indicator that affirmatively distinguishes the corresponding said resource in the received transaction data that is to be used for the finding of the matching resource in the resources of interest in the resource set.

 9. The computer implemented method as defined in Exemplary Implementation No. 30 1, wherein:

a transaction handler within the payment processing system processes each said transaction conducted on a corresponding said account;

each said merchant submits a corresponding said transaction to a corresponding acquirer for processing by the transaction handler who requests a corresponding issuer to obtain a

corresponding payment for the submitted transaction from a corresponding said account issued to a corresponding said member consumer by the corresponding said issuer; and

the corresponding said issuer forwards the obtained corresponding payment to the corresponding acquirer to pay the submitting merchant for the submitted transaction.

5 10. The computer implemented method as defined in Exemplary Implementation No. 1, wherein the steps further comprise receiving at least one request for a transfer of a specified amount of funds from one said account of one of the member consumers to a mutual payment said account that is accessible by each of the member consumers in the consumer group.

10 11. The computer implemented method as defined in Exemplary Implementation No. 10, wherein the steps further comprise:

receiving an authorization request to make one said transaction payable upon the mutual payment said account for one of the resources in the resource set;

15 receiving an authorization response to the authorization request including an approval of an issuer of the mutual payment said account to make the one said transaction payable upon the mutual said payment account; and

requesting the issuer of the mutual payment said account to obtain payment therefrom for the one said transaction, wherein the issuer forwards the obtained payment for delivery to a corresponding acquirer of a corresponding said merchant to pay the corresponding said merchant for the one of the resources in the resource set.

20 12. The computer implemented method as defined in Exemplary Implementation No. 1, wherein the steps further comprise:

receiving at least one request for partial payment towards a current said transaction for at least one of the resources in the resource set, wherein the at least one request for partial payment includes:

25 an account identifier of a corresponding said account issued to one of the member consumers by an issuer; and

an amount of funds to apply towards the partial payment;

and

30 facilitating application of the amount of funds of the at least one request for partial payment towards the current said transaction for the at least one of the resources.

13. The computer implemented method as defined in Exemplary Implementation No. 12, wherein the step of facilitating the application of the amount of funds includes:

receiving information about a selected said merchant offering to sell the at least one of the resources; and

sending at least one clearing and settling request, to an issuer of the corresponding said account, to forward the amount of funds for delivery to the selected said merchant as the corresponding partial payment towards the current said transaction for the at least one of the resources in the resource set.

5 14. An apparatus comprising a computer readable medium including stored instructions that, when executed by a computing apparatus, the computing apparatus performs the steps of:

 receiving transaction data for a plurality of transactions of a plurality of merchants, wherein:

10 each said transaction is conducted by a consumer with one said merchant; and the transaction data for each said transaction includes:

 information about a resource purchased in the transaction; and

 a consumer identifier of the consumer;

 receiving data specifying a consumer group, wherein each member said consumer in the
15 consumer group has a corresponding said consumer identifier usable to distinguish the member said consumer from other said consumers;

 using the consumer identifiers in the transaction data to distinguish the transactions of the each member said consumer from other said consumers;

 identifying a predicted resource set including resources predicted to be of interest to the
20 member said consumers based at least in part on the distinguished said transactions; and

 announcing information about the predicted resource set to at least one of the member said consumers.

 15. The apparatus as defined in Exemplary Implementation No. 14, wherein the computer readable medium further comprises stored instructions that, when executed by the
25 computing apparatus, the computing apparatus performs the steps of:

 determining a subset of the predicted resource set based at least in part on corresponding said transaction data of the transactions of a first member said consumer by:

 comparing the resources in the predicted resource set with the resources
 purchased in the corresponding said transactions of the first member said consumer to
30 find one or more matches; and

 compiling the subset of the predicted resource set based on the one or more matches;

 and

 announcing the subset of the predicted resource set to the first member said consumer.

16. The apparatus as defined in Exemplary Implementation No. 14, wherein the computer readable medium further comprises stored instructions that, when executed by the computing apparatus, the computing apparatus performs the steps of:

- 5 receiving a query from a first said consumer requesting information about at least the predicted resource set;
- using the consumer identifier corresponding to the first said consumer to distinguish the first said consumer as one of the member said consumers; and
- announcing, if the first said consumer is one of the member said consumers, the requested information to the first said consumer.

- 10 17. The apparatus as defined in Exemplary Implementation No. 14, wherein:
- a transaction handler, within the payment processing system, processes the each said transaction upon a corresponding said account of one said consumer engaged in the transaction;
- a corresponding said merchant submits a corresponding said transaction to a corresponding acquirer for processing by the transaction handler who requests a corresponding
- 15 issuer of the corresponding said account to obtain a payment for the transaction from the corresponding said account; and
- the corresponding issuer forwards the obtained payment to the corresponding acquirer to pay the corresponding said merchant for the submitted said transaction.

- 20 18. A computer implemented method comprising a plurality of steps each being performed using a computing apparatus executing software, the steps including:
- in a payment processing system which notifies a member of at least one transaction conducted upon an account for resources of any of a plurality of merchants, wherein each said transaction is processed for payment to the any of the plurality of merchants:
- receiving an address for each of a plurality of said members of an interest group for a
- 25 person of interest;
- receiving information about a plurality of said transactions;
- distinguishing one or more said transactions each being:
- conducted between the person of interest and one said merchant; and
- upon an endorsement said account for the resource of the one said merchant;
- 30 and
- for each of the distinguished one or more said transactions:
- facilitating movement of funds from an endorsee under contract with the person of interest for deposit in the endorsement said account to pay the one said merchant for the purchase of the resource; and

transmitting data about the transaction conducted by the person of interest upon the endorsement said account to at least one said address.

19. The computer implemented method as defined in Exemplary Implementation No. 18, wherein the data about the transaction includes information about the resource of the one said merchant.

20. The computer implemented method as defined in Exemplary Implementation No. 18, wherein:

a transaction handler processes each said transaction conducted upon a corresponding said account;

each said merchant submits each said transaction to a corresponding acquirer for processing by the transaction handler who requests a corresponding issuer to obtain a corresponding payment for the each said transaction from the corresponding said account; and

the corresponding issuer forwards the obtained corresponding payment to the corresponding acquirer to pay the submitting said merchant for the submitted said transaction.

21. The computer implemented method as defined in Exemplary Implementation No. 18, wherein, for each of the distinguished one or more said transactions, the steps further comprise:

receiving an authorization request having a merchant indicator associated with the one said merchant;

comparing the merchant indicator in the authorization request with a corresponding said merchant indicator of one of the endorsees to find a match;

and

forwarding an authorization response, responsive to the authorization request, for delivery to the one said merchant engaged in the transaction.

Exemplary implementations corresponding to US Patent Application Serial No. 12/428,382, filed on April 22, 2009, titled "Announcing Information about Payment Transactions of Any Member of A Consumer Group," as Attorney Docket No. P-14245US2 (930676.00209):

1. A computer implemented method comprising a plurality of steps each being performed using a computing apparatus executing software, the steps including:

in a payment processing system which notifies a member consumer of at least one transaction for resources between any of a plurality of merchants and any said member consumer

in a consumer group, wherein each said transaction is conducted on an account issued to a corresponding said member consumer that is processed for payment to a corresponding said merchant:

forming a query of one said member consumer:

5 requesting information about the at least one transaction conducted on a corresponding said account; and

 including a code usable to distinguish the at least one transaction from other said transactions, wherein the requesting one said member consumer is not an accountholder of the corresponding said account;

10 and

 receiving an announcement including the information about the at least one transaction that is distinguished by using the code.

2. The computer implemented method as defined in Exemplary Implementation No. 1, wherein:

15 the code is further usable to determine that the requesting one said member consumer is one of the member consumers; and

 the announcement is received after the requesting said member consumer is determined to be one of the member consumers.

3. The computer implemented method as defined in Exemplary Implementation No. 20 1, wherein the announcement includes at least one of:

 an identifier of the any said member consumer engaged in the at least one transaction;

 a merchant identifier of the merchant engaged in the at least one transaction;

 an offer:

 of the merchant engaged in the at least one transaction;

25 for a future said transaction;

 with the requesting one said member consumer; and

 for the resource purchased in the at least one transaction;

 a purchase amount of the resource purchased in the at least one transaction;

 a first resource identifier of the resource purchased in the at least one transaction;

30 a second resource identifier of at least one said resource that none of the member consumers has previously purchased in a corresponding said transaction processed in the payment processing system within a duration of time;

a third resource identifier of at least one said resource that is predicted to be of interest to at least one of the member consumers based on the resources previously purchased by the member consumers in the transactions processed the payment processing system;

the resource identifier of at least one said resource within a pre-selected resource set
5 including said resources of interest to the member consumers;

an alert that the payment processing system has received an authorization request for the at least one transaction for at least one of the resources of interest; and

a manufacturer identifier of a manufacturer of at least one of the resources previously purchased in the at least one transaction.

10 4. The computer implemented method as defined in Exemplary Implementation No. 1, wherein:

the steps further comprise forming a transmission including position data usable to determine when a first said member consumer is present in a zone;

the announcement includes data about at least one said merchant capable of engaging in
15 a future said transaction for at least one said resource predicted to be of interest to at least one of the member consumers based upon the resources previously purchased by the member consumers in the transactions;

and

the receiving occurs when the first said member consumer is present in the zone.

20 5. The computer implemented method as defined in Exemplary Implementation No. 1, wherein:

the announcement includes an update to a resource set having resources of interest to at least one of the member consumers; and

the update is created by removing, from the resource set, the resources of interest that
25 were previously purchased in one said transaction processed in the payment processing system.

6. The computer implemented method as defined in Exemplary Implementation No. 5, wherein the steps further comprise forming a transmission including a request that a payment amount be made payable upon a corresponding said account of the requesting said member consumer towards one said transaction for at least one said resource of interest in the update.

30 7. The computer implemented method as defined in Exemplary Implementation No. 5, wherein the update consists of information about the resources of interest that cost within a range of currency amounts determined, in part, by a spend over a plurality of said transactions upon at least one corresponding said account of the requesting said member consumer.

8. The computer implemented method as defined in Exemplary Implementation No. 1, wherein:

a transaction handler within the payment processing system processes each said transaction;

5 each said merchant submits a corresponding said transaction to a corresponding acquirer for processing by the transaction handler who requests a corresponding issuer to obtain a corresponding payment for the submitted transaction from the corresponding said account issued to the corresponding said member consumer by a corresponding said issuer; and

10 the corresponding said issuer forwards the obtained corresponding payment to the corresponding acquirer to pay the submitting said merchant for the submitted said transaction.

9. A computer implemented method comprising a plurality of steps each being performed using a computing apparatus executing software, the steps including:

15 forming a transmission specifying member consumers of a consumer group, wherein each specified said member consumer is issued a corresponding account within a payment processing system;

and

20 receiving an announcement including information about at least one Resource Predicted to be of Interest (RPI) to at least one of the member consumers, wherein the RPI is algorithmically determined from data about resources purchased in transactions within the payment processing system upon corresponding said accounts between any of a plurality of merchants and at least one of the specified said member consumers.

10. The computer implemented method as defined in Exemplary Implementation No. 9, wherein the steps further comprise receiving a second transmission having an indicator:

25 to be associated with each said transaction of one said member consumer; and usable to affirmatively distinguish the each said transaction as one having data about at least one said resource for inclusion in the algorithmic determination of the RPI.

11. The computer implemented method as defined in Exemplary Implementation No. 10, wherein the steps further comprise associating the indicator with the each said transaction by at least using a point of interaction terminal to form a third transmission:

30 during one said transaction between one said merchant and the one said member consumer; and

including the indicator.

12. The computer implemented method as defined in Exemplary Implementation No. 9, wherein:

a first said member consumer receives the announcement;
the information about at least one RPI includes data about a subset of the RPI; and
the subset is selected by using an algorithm to remove, from the RPI, resources matching
the RPI that the first specified said member consumer has previously purchased in corresponding
5 said transactions of the first specified said member consumer.

13. The computer implemented method as defined in Exemplary Implementation No.
9, wherein announcement includes an offer of at least one of the merchants for a future said
transaction for at least one said resource within the RPI.

14. The computer implemented method as defined in Exemplary Implementation No.
10 9, wherein:

the steps further comprise forming a second transmission including position data usable
to determine when a first said member consumer is present in a spatial zone;

the announcement includes data about one said merchant capable of engaging in a future
said transaction for at least one resource in the RPI;

15 and

the receiving occurs when the first said member consumer is present in the spatial zone.

15. The computer implemented method as defined in Exemplary Implementation No.
9, wherein the steps further comprise forming a second transmission including a request that a
payment amount be made payable upon a corresponding said account of one said member
20 consumer in a current said transaction for at least one of the resources in the RPI.

16. An apparatus comprising a computer readable medium including stored
instructions that, when executed by a computing apparatus, the computing apparatus performs
the steps of:

forming a transmission specifying at least one member consumer of a consumer group,
25 wherein each said member consumer is issued a corresponding account within a payment
processing system;

forming a second transmission specifying a resource, of any of a plurality of merchants,
that is of interest to at least one said member consumer;

and

30 receiving an announcement including information about a resource set, wherein the
resource set consists of data about at least one said resource of interest that is unmatched to
resources previously purchased, over a specified window of time, using any of the accounts of
the corresponding said member consumers.

17. The apparatus as defined in Exemplary Implementation No. 16, wherein the computer readable medium further comprises stored instructions that, when executed by the computing apparatus, the computing apparatus performs the step of forming a third transmission including a request that a payment amount be made payable upon one said account of a
5 corresponding said member consumer towards a purchase of at least one said resource of interest in the resource set.

18. The apparatus as defined in Exemplary Implementation No. 16, wherein the computer readable medium further comprises stored instructions that, when executed by the computing apparatus, the computing apparatus performs the steps of:

10 forming a third transmission including position data usable to determine when the apparatus is present in a spatial zone; and

the announcement further includes data about at least one said merchant capable of engaging in a future purchase of at least one of the resource in the resource set, wherein the announcement is received while the apparatus is in the spatial zone.

15 19. The apparatus as defined in Exemplary Implementation No. 18, wherein the announcement further includes an offer of the one said merchant, for the future said purchase.

20. The apparatus as defined in Exemplary Implementation No. 16, wherein the apparatus is selected from the group consisting of:

a contactless device including a wireless processor, a transmitter, and a receiver;

20 a smart card;

a cellular telephone;

a personal digital assistant;

a digital audio player;

a global positioning system enabled device;

25 a computer; and

a combination of any of the above portable consumer devices.

Another Exemplary Payment Processing System

Figure 8 illustrates another exemplary payment processing system 800. Payment
30 processing system can be operated in the environment of Figure 1 which an announcement recipient of the implementations disclosed herein can receive an announcement. The general environment of Figure 1 include that of a merchant (m) 810, such as the merchant (m) 104, who can conduct a transaction for goods and/or services with an account user (au) (e.g., consumer (c) 102) on an account issued to an account holder (a) 808 by an issuer (i) 804 (e.g., issuer (i) 202),

where the processes of paying and being paid for the transaction are coordinated by a transaction handler 802 (*e.g.*, the transaction handler (th) 206). The transaction includes participation from different entities that are each a component of the payment processing system 800. The payment processing system 800 has a plurality of merchants (m) 810 that includes merchant (1) 810
5 through merchant (M) 810, where M can be up to and greater than an eight digit integer.

Payment processing system 800 has a plurality of accounts 808 each of which is held by a corresponding account holder (1) 808 through account holder (A) 808, where A can be up to and greater than a ten eight digit integer.

Payment processing system 800 includes account user (1) 808 through account user (AU)
10 808, where AU can be as large as a ten digit integer or larger. Each account user (au) conducts a transaction with merchant (m) 810 for goods and/or services using the account that has been issued by an issuer (i) 804 to a corresponding account holder (a) 808. Data from the transaction on the account is collected by the merchant (m) 810 and forwarded to a corresponding acquirer (a) 806 (*e.g.*, the acquirer (q) 204). Acquirer (a) 806 forwards the data to transaction handler 802
15 who facilitates payment for the transaction from the account issued by the issuer (i) 804 to account holder (a) 808.

Payment processing system 800 has a plurality of issuers (1-i) 804. Each issuer (i) 804 may be assisted in processing one or more transactions by a corresponding agent issuer (ai) 804, where 'i' can be an integer from 1 to I, where 'ai' can be an integer from 1 to AI, and where I and
20 AI can be as large as an eight digit integer or larger.

Payment processing system 800 has a plurality of acquirers (q) 806. Each acquirer (q) 806 may be assisted in processing one or more transactions by a corresponding agent acquirer (aq) 806, where 'q' can be an integer from 1 to Q, where aq can be an integer from 1 to AQ, and where Q and AQ can be as large as a eight digit integer or larger.

The transaction handler 802 may process a plurality of transactions within the payment processing system 800. The transaction handler 802 can include one or a plurality of networks and switches (ns) 802. Each network/switch (ns) 802 can be a mainframe computer in a geographic location different than each other network/switch (ns) 802, where 'ns' is an integer from one to NS, and where NS can be as large as a four digit integer or larger.

Dedicated communication systems 820, 822 (*e.g.*, private communication network(s))
30 facilitate communication between the transaction handler 802 and each issuer (i) 804 and each acquirer (a) 806. The Network 812, via e-mail, the World Wide Web, cellular telephony, and/or other optionally public and private communications systems, can facilitate communications 822a-822c among and between each issuer (i) 804, each acquirer (a) 806, each merchant (m)

810, each account holder (a) 808, and the transaction handler 802. Alternatively and optionally, one or more dedicated communication systems 824, 826, and 828 can facilitate respective communications between each acquirer (a) 806 and each merchant (m) 810, each merchant (m) and each account holder (a) 808, and each account holder (a) 808 and each issuer (i) 804, respectively.

Each acquirer (q) 806 may be assisted in processing one or more transactions by a corresponding agent acquirer (aq) 806, where 'q' can be an integer from 1 to Q, where aq can be an integer from 1 to AQ, and where Q and AQ can be as large as a eight digit integer or larger.

Merchant (m) 810 may be a person or entity that sells goods and/or services. Merchant (m) 810 may also be, for instance, a manufacturer, a distributor, a retailer, a load agent, a drugstore, a grocery store, a gas station, a hardware store, a supermarket, a boutique, a restaurant, or a doctor's office. In a business-to-business setting, the account holder (a) 808 may be a second merchant (m) 810 making a purchase from another merchant (m) 810. Merchant (m) 810 may utilize at least one point-of-interaction terminal (*e.g.*, Point of Service or browser enabled consumer cellular telephone) that can communicate with the account user (au) 808, the acquirer (a) 806, the transaction handler 802, or the issuer (i) 804. Thus, the point-of-interaction terminal is in operative communication with the payment processing system 800.

Typically, a transaction begins with account user (au) 808 presenting the portable consumer device to the merchant (m) 810 to initiate an exchange for a good or service. The portable consumer device may be associated with an account (*e.g.*, a credit account) of account holder (a) 808 that was issued to the account holder (a) 808 by issuer (i) 804.

The portable consumer device may be in a form factor that can be a payment card, a gift card, a smartcard, a smart media, a payroll card, a healthcare card, a wrist band, a machine readable medium containing account information, a keychain device, such as a SPEEDPASS® device commercially available from ExxonMobil Corporation, a supermarket discount card, a cellular telephone, personal digital assistant, a pager, a security card, an access card, a wireless terminal, or a transponder. The portable consumer device may include a volatile or non-volatile memory to store information such as the account number or an account holder (a) 808's name.

Merchant (m) 810 may use the point-of-interaction terminal to obtain account information, such as a number of the account of the account holder (a) 808, from the portable consumer device. The portable consumer device may interface with the point-of-interaction terminal using a mechanism including any suitable electrical, magnetic, or optical interfacing system such as a contactless system using radio frequency or magnetic field recognition system or contact system such as a magnetic stripe reader. The point-of-interaction terminal sends a

transaction authorization request to the issuer (i) 804 of the account associated with the portable consumer device. Alternatively, or in combination, the portable consumer device may communicate with issuer (i) 804, transaction handler 802, or acquirer (a) 806.

Issuer (i) 804 may authorize the transaction and forward same to the transaction handler
5 802. Transaction handler 802 may also clear the transaction. Authorization includes issuer (i) 804, or transaction handler 802 on behalf of issuer (i) 804, authorizing the transaction in connection with issuer (i) 804's instructions such as through the use of business rules. The business rules could include instructions or guidelines from the transaction handler 802, the account holder (a) 808, the merchant (m) 810, the acquirer (a) 806, the issuer (i) 804, a related
10 financial institution, or combinations thereof. The transaction handler 802 may maintain a log or history of authorized transactions. Once approved, the merchant (m) 810 may record the authorization, allowing the account user (au) 808 to receive the good or service from merchant (m) or an agent thereof.

The merchant (m) 810 may, at discrete periods, such as the end of the day, submit a list
15 of authorized transactions to the acquirer (a) 806 or other transaction related data for processing through the payment processing system 800. The transaction handler 802 may compare the submitted authorized transaction list with its own log of authorized transactions. The transaction handler 802 may route authorization transaction amount requests from the corresponding the acquirer (a) 806 to the corresponding issuer (i) 804 involved in each transaction. Once the
20 acquirer (a) 806 receives the payment of the authorized transaction from the issuer (i) 804, the acquirer (a) 806 can forward the payment to the merchant (m) 810 less any transaction costs, such as fees for the processing of the transaction. If the transaction involves a debit or pre-paid card, the acquirer (a) 806 may choose not to wait for the issuer (i) 804 to forward the payment prior to paying merchant (m) 810.

25 There may be intermittent steps in the foregoing process, some of which may occur simultaneously. For example, the acquirer (a) 806 can initiate the clearing and settling process, which can result in payment to the acquirer (a) 806 for the amount of the transaction. The acquirer (a) 806 may request from the transaction handler 802 that the transaction be cleared and settled. Clearing includes the exchange of financial information between the issuer (i) 804 and
30 the acquirer (a) 806 and settlement includes the exchange of funds. The transaction handler 802 can provide services in connection with settlement of the transaction. The settlement of a transaction includes depositing an amount of the transaction settlement from a settlement house, such as a settlement bank, which transaction handler 802 typically chooses, into a clearinghouse, such as a clearing bank, that acquirer (a) 806 typically chooses. The issuer (i) 804 deposits the

same from a clearinghouse, such as a clearing bank, which the issuer (i) 804 typically chooses, into the settlement house. Thus, a typical transaction involves various entities to request, authorize, and fulfill processing the transaction.

The payment processing system 800 will preferably have network components suitable
5 for scaling the number and data payload size of transactions that can be authorized, cleared and settled in both real time and batch processing. These include hardware, software, data elements, and storage network devices for the same. Examples of payment processing system 800 include those operated, at least in part, by: American Express Travel Related Services Company, Inc; MasterCard International, Inc.; Discover Financial Services, Inc.; First Data Corporation; Diners
10 Club International, LTD; Visa Inc.; and agents of the foregoing.

Each of the network/switch (ns) 802 can include one or more data centers for processing transactions, where each transaction can include up to 100 kilobytes of data or more. The data corresponding to the transaction can include information about the types and quantities of goods and services in the transaction, information about the account holder (a) 808, the account user
15 (au) 808, the merchant (m) 810, tax and incentive treatment(s) of the goods and services, coupons, rebates, rewards, loyalty, discounts, returns, exchanges, cash-back transactions, etc.

By way of example, network/switch (ns) 802 can include one or more mainframe computers (*e.g.*, one or more IBM mainframe computers) for one or more server farms (*e.g.*, one or more Sun UNIX Super servers), where the mainframe computers and server farms can be in
20 diverse geographic locations.

Each issuer (i) 804 (or agent issuer (ai) 804 thereof) and each acquirer (a) 806 (or agent acquirer (aq) 806 thereof) can use or more router/switch (*e.g.*, Cisco™ routers/switches) to communicate with each network/switch (ns) 802 via dedicated communication systems.

Transaction handler 802 can store information about transactions processed through
25 payment processing system 800 in data warehouses such as may be incorporated as part of the plurality of networks/switches 802. This information can be data mined. The data mining transaction research and modeling can be used for advertising, account holder and merchant loyalty incentives and rewards, fraud detection and prediction, and to develop tools to demonstrate savings and efficiencies made possible by use of the payment processing system
30 800 over paying and being paid by cash, or other traditional payment mechanisms.

The VisaNet® system is an example component of the transaction handler 802 in the payment processing system 800. Presently, the VisaNet® system is operated in part by Visa Inc. As of 2007, the VisaNet® system Inc. was processing around 300 million transaction daily, on over 1 billion accounts used in over 170 countries. Financial instructions numbering over

16,000 connected through the VisaNet® system to around 30 million merchants (m) 810. In 2007, around 81 billion transactions for about 4 trillion U.S. dollars were cleared and settled through the VisaNet® system, some of which involved a communication length of around 24,000 miles in around two (2) seconds.

5 The various steps or acts in a method or process may be performed in the order shown, or may be performed in another order. Additionally, one or more process or method steps may be omitted or one or more process or method steps may be added to the methods and processes. An additional step, block, or action may be added in the beginning, end, or intervening existing elements of the methods and processes. Based on the disclosure and teachings provided herein, a
10 person of ordinary skill in the art will appreciate other ways and/or methods for various implements. Moreover, it is understood that a functional step of described methods or processes, and combinations thereof can be implemented by computer program instructions that, when executed by a processor, create means for implementing the functional steps. The instructions may be included in computer readable medium that can be loaded onto a general purpose
15 computer, a special purpose computer, or other programmable apparatus.

 It is understood that the examples and implementations described herein are for illustrative purposes only and that various modifications or changes in light thereof will be suggested to persons skilled in the art and are to be included within the spirit and purview of this application and scope of the appended claims.

CLAIMS

What is claimed is:

1. A computer implemented method comprising a plurality of steps each being performed using a computing apparatus executing software, the steps including:
 - 5 receiving transaction data for each of a plurality of transactions for resources of any of a plurality of merchants within a payment processing system, wherein:
 - each said transaction is conducted on an account issued to a corresponding said consumer that is processed for payment to a corresponding said merchant; and
 - the transaction data for the each said transaction includes an indicator usable to
10 distinguish the corresponding said merchant engaged in the each said transaction;
receiving a query of a first said consumer:
 - requesting an announcement about at least one said transaction of a target said
merchant with one said consumer that is different from the first said consumer; and
 - including data usable to determine the indicator of the target said merchant;
15 using the data included in the query to determine the indicator of the target said
merchant;
 - distinguishing the at least one said transaction of the target said merchant from among the
plurality of said transactions by finding at least one match between the determined said indicator
of the target said merchant with the indicator included in the received transaction data;
20 and
 - forming the announcement including information based on the transaction data of the
distinguished at least one said transaction, wherein the announcement is for delivery to the first
said consumer.
2. The computer implemented method of Claim 1, wherein the query is received
25 while the first said consumer is present within a zone that includes a location of the target said
merchant.
3. The computer implemented method of Claim 2, wherein the zone is selected from
the group consisting of:
 - a spatial zone;
 - 30 an Internet zone;
 - a virtual zone; and
 - a combination of any of the above zones.

4. The computer implemented method of Claim 1, wherein the target said merchant is selected from the group consisting of:

one said merchant that is identified in the query by the first said consumer; and
one said merchant that is:

5 unidentified in the query by the first said consumer; and
 located within a zone that is identified in the query by the first said consumer.

5. The computer implemented method of Claim 1, wherein the information included in the announcement is selected from the group consisting of:

10 data about a price paid for one said resource in the distinguished at least one said
transaction of the target said merchant;

 a confirmation that a current advertised said price for the one said resource of the target
said merchant is less than the price paid in the distinguished at least one said transaction of the
target said merchant;

15 an indication of a return, to the target said merchant, of the one said resource purchased
in the distinguished at least one said transaction of the target said merchant;

 an indication of an incentive provided, under a loyalty program, to a corresponding said
consumer engaged in the distinguished at least one said transaction of the target said merchant;

 an indication of a quantity of the distinguished at least one said transaction of the target
said merchant; and

20 a combination of any of the above information.

6. The computer implemented method of Claim 1, wherein the steps further comprise, subsequent to the step of forming the announcement, receiving a transmission including a communication from the first said consumer for delivery to the target said merchant.

7. The computer implemented method of Claim 6, wherein the communication
25 includes an offer from the first said consumer to purchase a corresponding said resource
previously sold in the distinguished at least one said transaction of the target said merchant,
wherein:

 the corresponding said resource was previously sold at a previous price; and
 the offer is to purchase the corresponding said resource at the previous price.

30 8. The computer implemented method of Claim 7, further comprising the step of
receiving an authorization request for one said transaction between the target said merchant and
the first said consumer for the corresponding said resource at the previous price.

9. An apparatus comprising a computer readable medium including stored instructions that, when executed by a computing apparatus, the computing apparatus performs the steps of:

receiving data about a plurality of transactions each between a corresponding merchant
5 and a corresponding consumer for corresponding resources, wherein the data about each said transaction includes an indicator usable to distinguish the each said transaction as occurring with a corresponding said merchant;

receiving a query of a first said consumer requesting an announcement about at least one
10 said transaction of at least one target said merchant located within a spatial zone, wherein the spatial zone is specified by the first said consumer;

using a corresponding said indicator of the at least one target said merchant to distinguish
the at least one said transaction of the at least one target said merchant; and

forming the announcement, responsive to the query:

including information based on the transaction data of the distinguished said at
15 least one said transaction; and

for delivery to a portable consumer device that is co-located with the first said
consumer.

10. The apparatus of Claim 9, wherein:

the spatial zone is delineated by at least one specified distance relative to a position of the
20 portable consumer device; and

the computer readable medium further comprises stored instructions that, when executed
by the computing apparatus, the computing apparatus performs the steps of:

receiving a transmission including information usable to determine a position of
the portable consumer device;

25 using at least the information included in the transmission to determine the position of the portable consumer device;

determining a location of each of a plurality of said merchants relative to the
determined position of the portable consumer device; and

identifying the at least one target said merchant by:

30 comparing the relative locations of the each of the plurality of said merchants to the at least one specified distance to find a match;

and

determining the corresponding indicators of each of the at least one target
said merchant.

11. The apparatus of Claim 9, wherein the information includes at least one of:
data about a price paid for one said resource in the distinguished at least one said
transaction;

a confirmation that a current advertised said price for the one said resource of the at least
5 one target said merchant is less than the price paid in the distinguished at least one said
transaction;

an indication of a return, to the at least one target said merchant, of the one said resource
purchased in the distinguished at least one said transaction;

an indication of an incentive provided, under a loyalty program, to a corresponding said
10 consumer engaged in the distinguished at least one said transaction;

an indication of a quantity of the distinguished at least one said transaction; and
a combination of any of the above.

12. The apparatus of Claim 9, wherein the portable consumer device is selected from
the group consisting of:

15 a financial card;

a contactless device including a wireless processor, a transmitter, and a receiver;

a smart card;

a cellular telephone;

a personal digital assistant;

20 a digital audio player;

a global positioning system enabled device;

a computer; and

a combination of any of the above portable consumer devices.

13. The apparatus of Claim 9, wherein:

25 a transaction handler within the payment processing system processes the plurality of said
transactions;

each said transaction is conducted upon a corresponding account of a corresponding said
consumer;

each said merchant submits a corresponding said transaction to a corresponding acquirer
30 for processing by the transaction handler who requests a corresponding issuer to obtain a
corresponding payment for the submitted transaction from a corresponding said account issued to
a corresponding said member consumer by the corresponding said issuer; and

the corresponding said issuer forwards the obtained corresponding payment to the
corresponding acquirer to pay the submitting said merchant for the submitted said transaction.

14. The apparatus of Claim 9, wherein the computer readable medium further comprises stored instructions that, when executed by the computing apparatus, the computing apparatus performs the step of, subsequent to the step of forming the announcement, receiving a transmission including a communication from the first said consumer for delivery to the at least one target said merchant.

15. A computer implemented method comprising a plurality of steps each being performed using a computing apparatus executing software, the steps including:

in a payment processing system which notifies a consumer of at least one transaction for resources between any of a plurality of merchants and any of a plurality of consumers, wherein each said transaction is conducted on an account issued to a corresponding consumer that is processed for payment to a corresponding said merchant:

receiving a query addressed from a shopper requesting data about at least one said transaction of a target said merchant, wherein the target said merchant is associated with an indicator usable to distinguish the at least one said transaction of the target said merchant from among other said transactions;

using the indicator to distinguish the at least one said transaction of the target said merchant from among the other said transactions;

and

forming an announcement:

including the data about the distinguished at least one said transaction of the target said merchant; and

for delivery to the shopper.

16. The computer implemented method of Claim 15, wherein the announcement further includes a merchant offer for a future said transaction for one said resource previously sold in the distinguished at least one said transaction.

17. The computer implemented method of Claim 16, wherein the merchant offer includes a discounted price for the at least one said resource, wherein the discounted price is lower than a price at which the at least one said resource was sold in the distinguished at least one said transaction.

18. The computer implemented method of Claim 15, wherein the steps further comprise, subsequent to the shopper receiving the announcement, receiving a transmission including a communication from the shopper for delivery to the target said merchant.

19. The computer implemented method of Claim 15, wherein the steps further comprise receiving a plurality of said transactions, wherein:

a transaction handler processes the plurality of said transactions;

each of the merchants submits corresponding said transactions to a corresponding said acquirer for processing by the transaction handler who requests corresponding issuers of the corresponding said accounts to obtain corresponding payments for the submitted corresponding said transactions from the corresponding accounts; and

the corresponding issuers forward the obtained corresponding payments for delivery to the corresponding acquirers to pay the submitting said merchant for the submitted said transactions.

20. The computer implemented method of Claim 15, wherein the data includes at least one of:

data about a price paid for one said resource in the distinguished at least one said transaction;

a confirmation that a current advertised said price for the one said resource of the at least one target said merchant is less than the price paid in the distinguished at least one said transaction;

an indication of a return, to the at least one target said merchant, of the one said resource purchased in the distinguished at least one said transaction;

an indication of an incentive provided, under a loyalty program, to a corresponding said consumer engaged in the distinguished at least one said transaction;

an indication of a quantity of the distinguished at least one said transaction; and
a combination of any of the above.

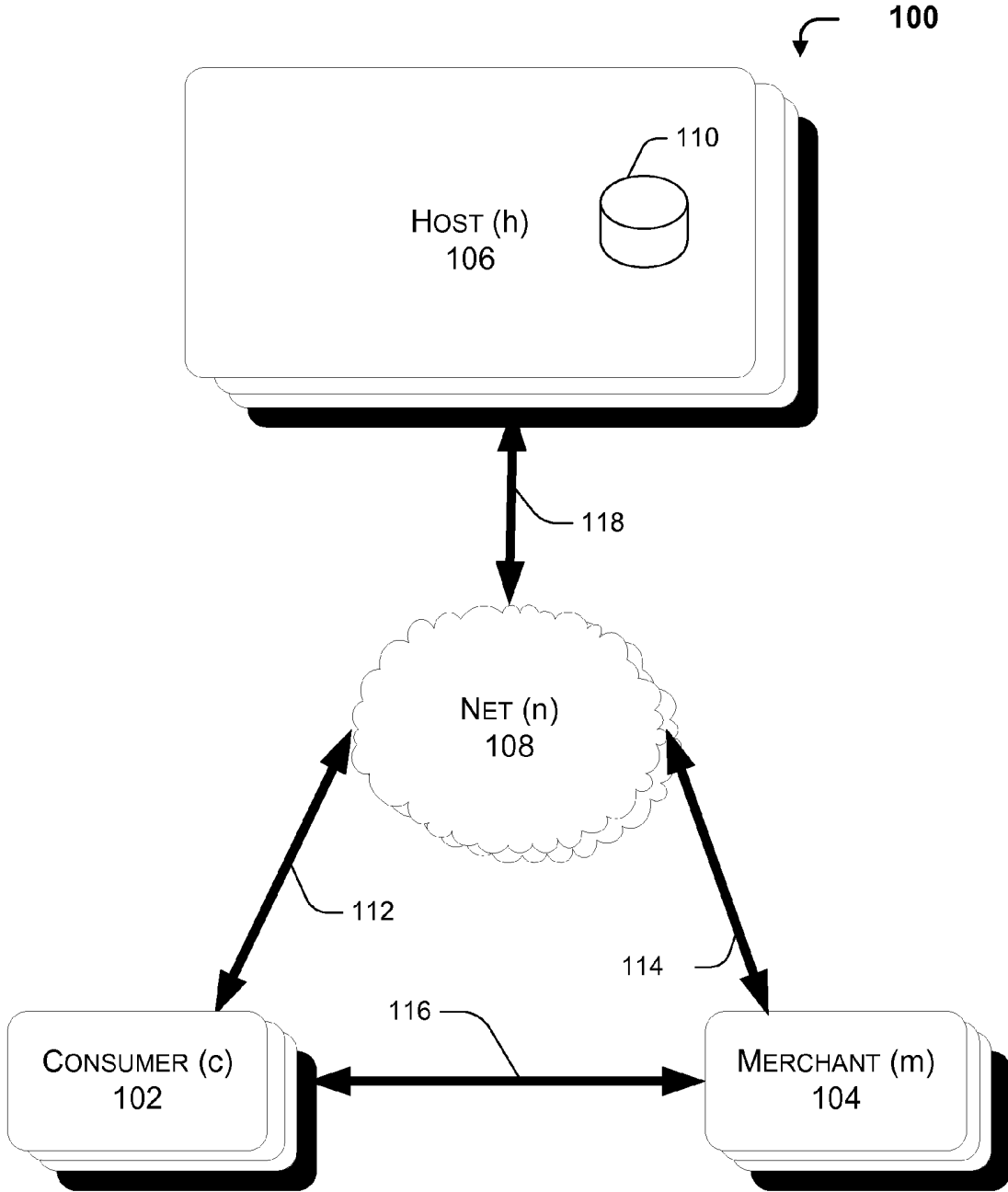

Figure 1

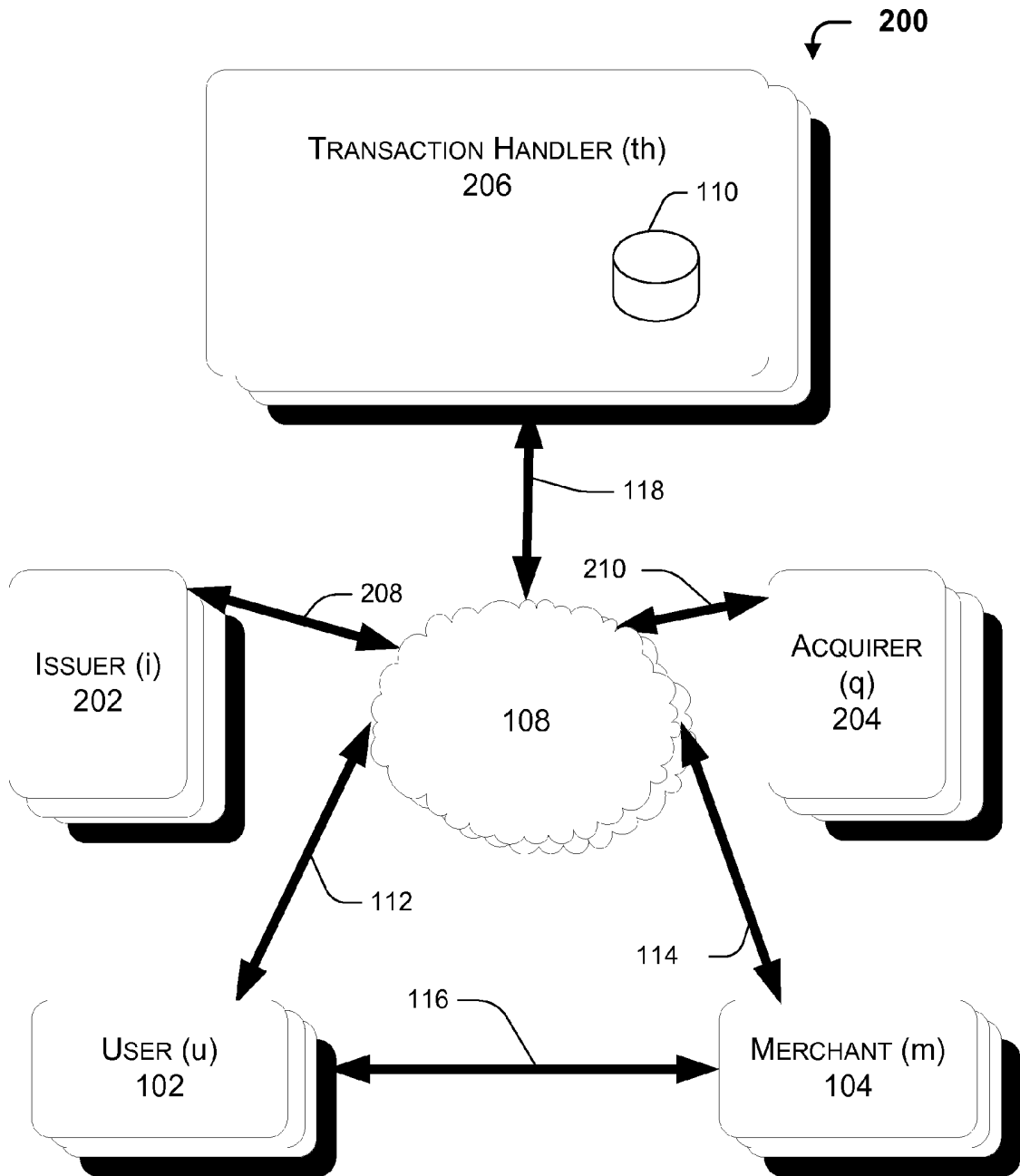

Figure 2

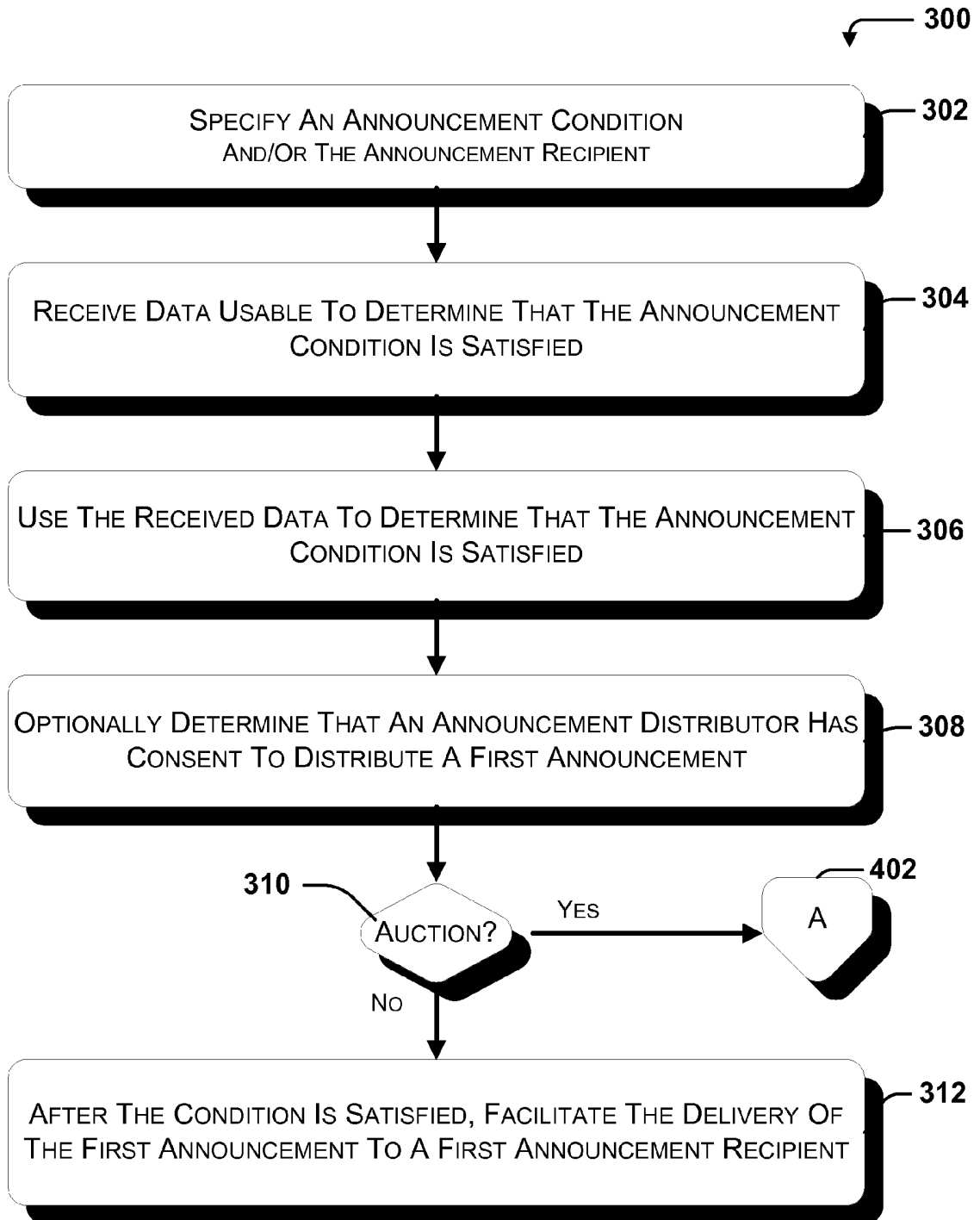

Figure 3

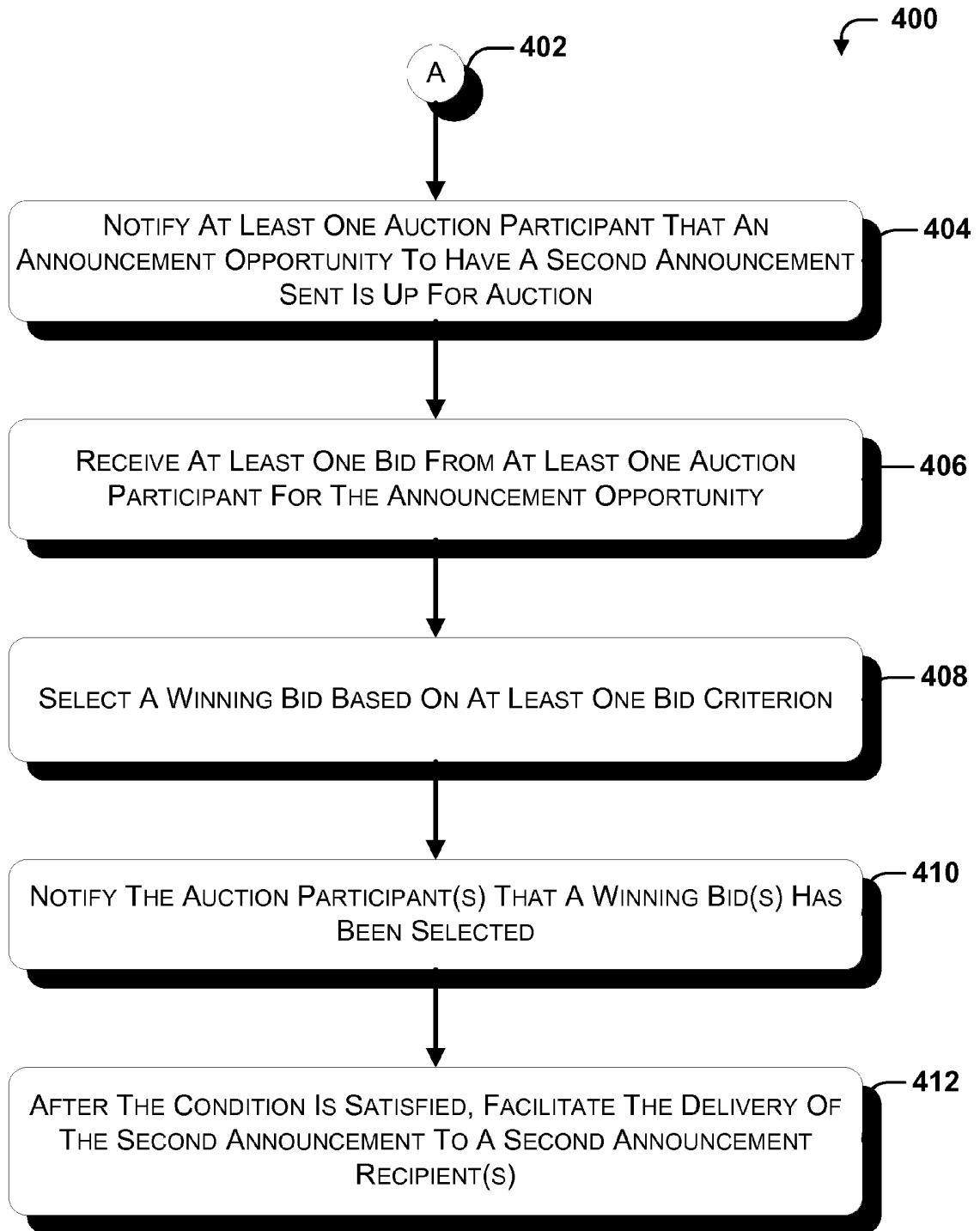

Figure 4

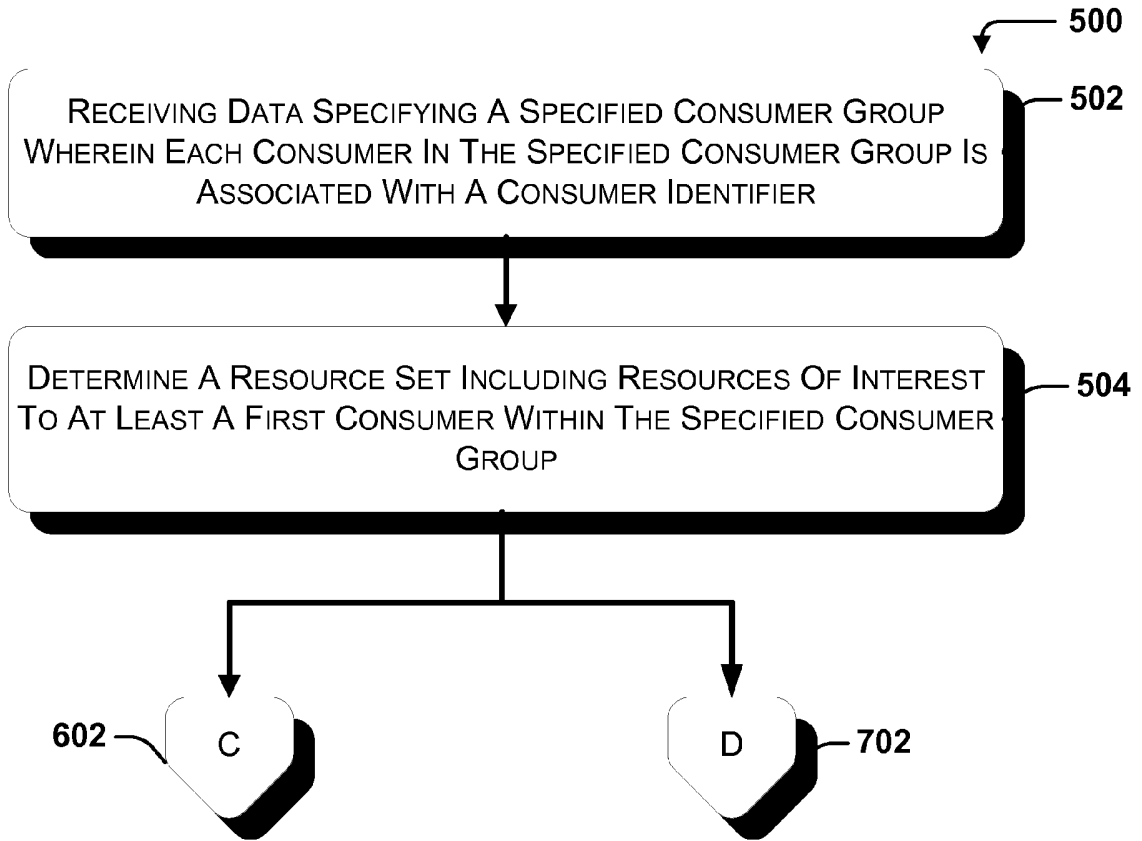

Figure 5

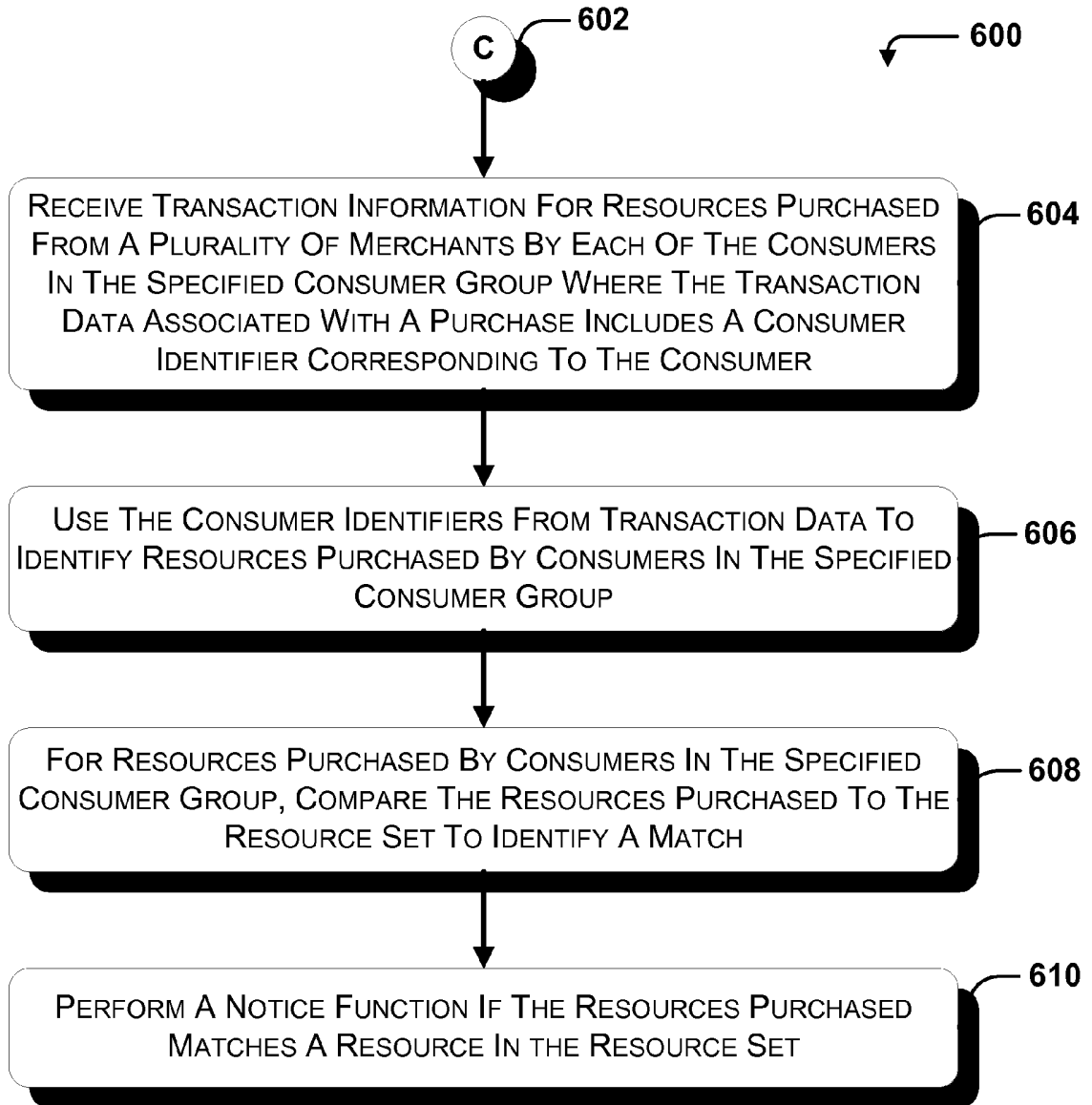

Figure 6

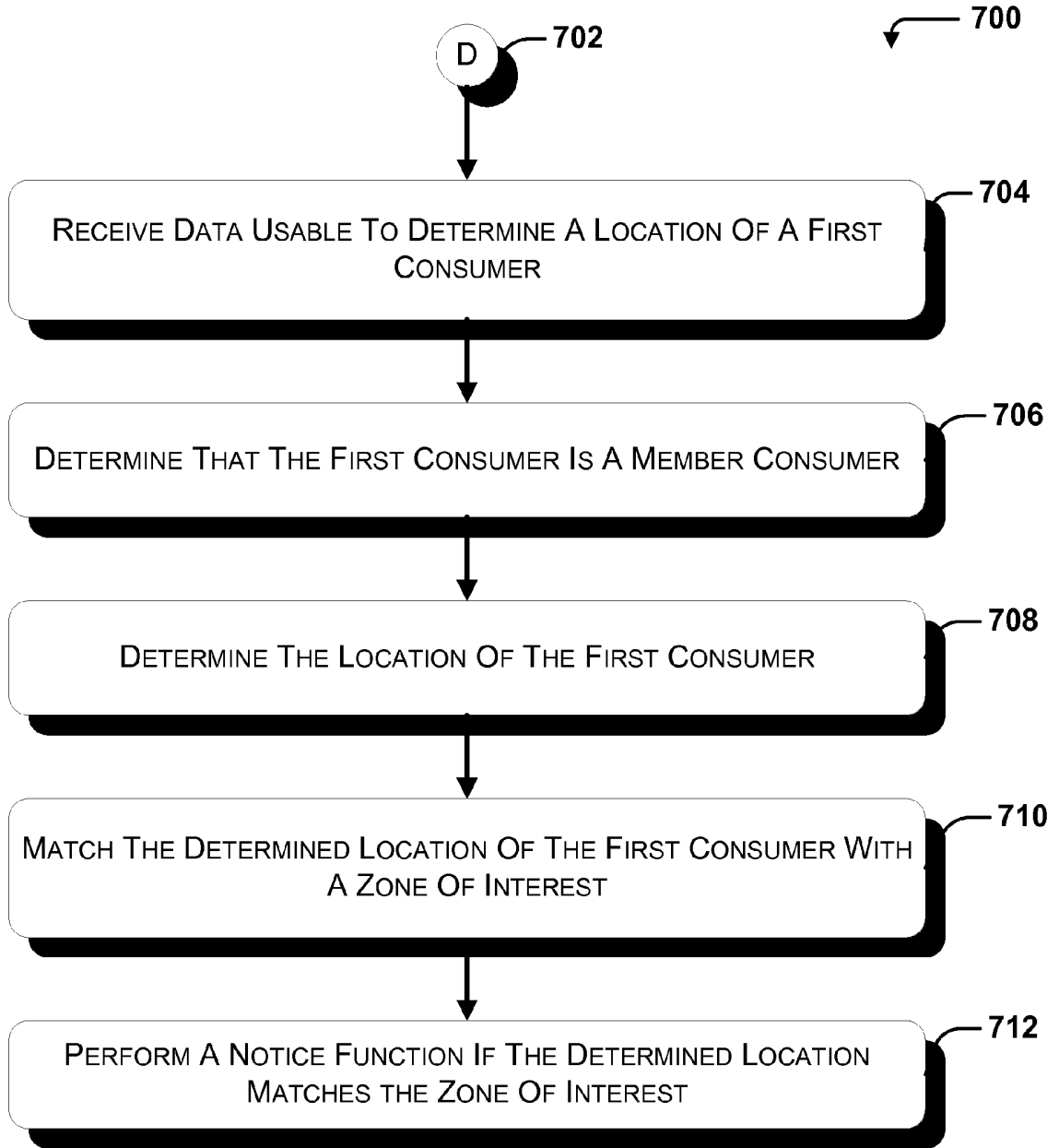

Figure 7

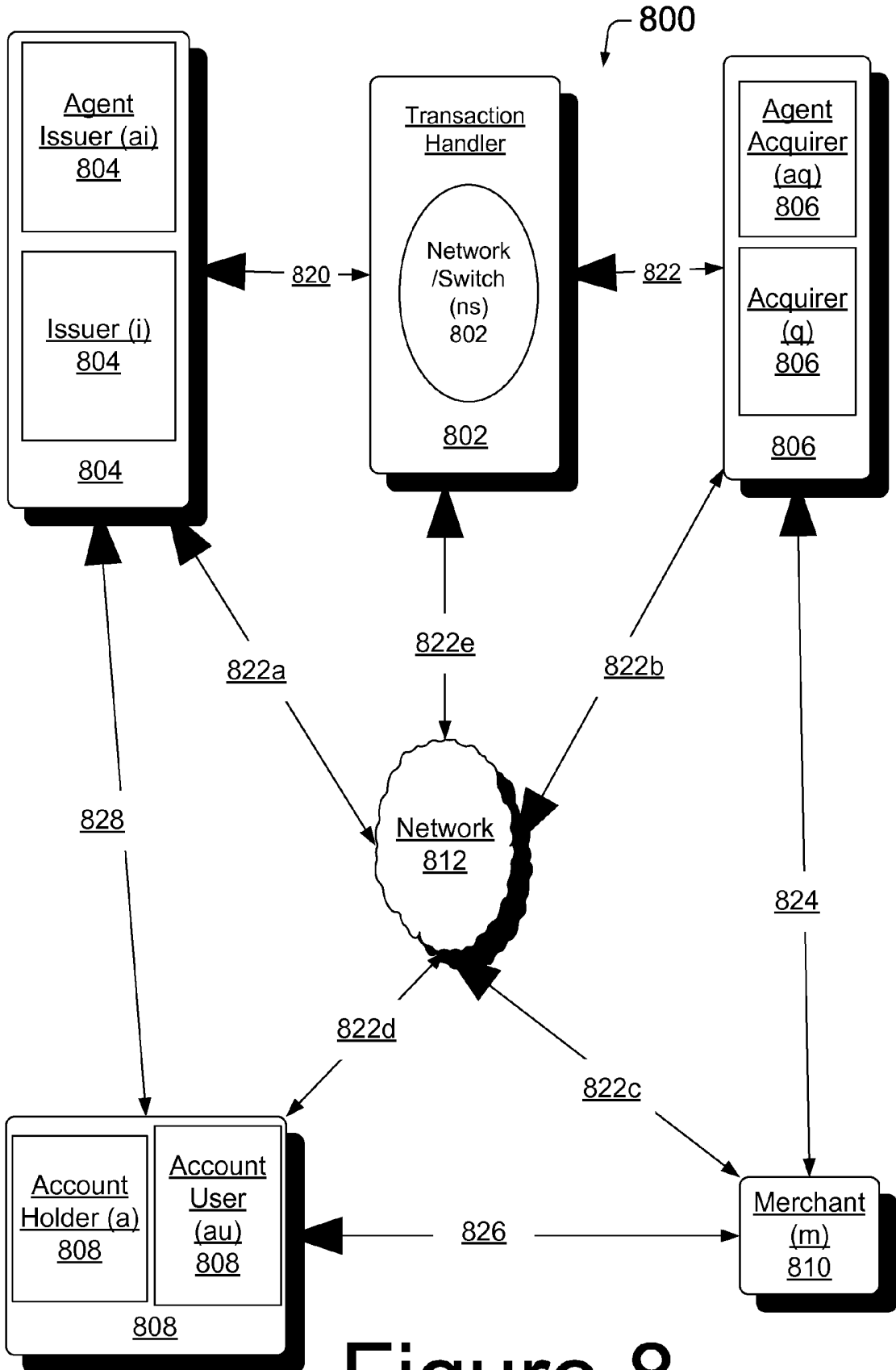

Figure 8