



INTERNATIONAL APPLICATION PUBLISHED UNDER THE PATENT COOPERATION TREATY (PCT)

<p>(51) International Patent Classification <sup>6</sup> : <b>H04L 12/28, 12/56, H04M 3/42</b></p>	<p><b>A1</b></p>	<p>(11) International Publication Number: <b>WO 98/54871</b> (43) International Publication Date: 3 December 1998 (03.12.98)</p>
<p>(21) International Application Number: PCT/US98/10451 (22) International Filing Date: 20 May 1998 (20.05.98)</p> <p>(30) Priority Data: 60/047,262 21 May 1997 (21.05.97) US 60/063,631 27 October 1997 (27.10.97) US</p> <p>(71) Applicant: BELL COMMUNICATIONS RESEARCH, INC. [US/US]; 445 South Street, Morristown, NJ 07960-6438 (US).</p> <p>(72) Inventors: BAJZATH, James, A., Jr.; 15 McCay Drive, Roebing, NJ 08554 (US). GHOGHARI, Nilay; 19 Tory Court, Bedminster, NJ 07921 (US). SMYK, Darek, A.; 15 Zirkel Avenue, Piscataway, NJ 08854 (US).</p> <p>(74) Agents: GIORDANO, Joseph et al.; c/o International Coordinator, Room 1G112R, 445 South Street, Morristown, NJ 07960-6438 (US).</p>		<p>(81) Designated States: CA, JP, European patent (AT, BE, CH, CY, DE, DK, ES, FI, FR, GB, GR, IE, IT, LU, MC, NL, PT, SE).</p> <p><b>Published</b> <i>With international search report. Before the expiration of the time limit for amending the claims and to be republished in the event of the receipt of amendments.</i></p>

(54) Title: SYSTEM AND METHOD FOR IMPLEMENTING CALL WAITING FUNCTIONS OVER A NETWORK

(57) Abstract

System and method for implementing call waiting functions over a network architecture which includes a public switched telephone network (PSTN) (210) and the Internet (120). The call waiting system (220) allows a user (205) to receive incoming call information from a third party without interrupting an active connection with a second party, such as an Internet Service Provider (ISP) (115). When the user (205) attempts to connect to the ISP (115), a call waiting service (220) is activated at a service control point (145) connected to the PSTN (210) and the user (205) is notified about any incoming call attempts made after the user (205) establishes a successful connection with the second party (115). If the user (205) is actively connected to the Internet (120), a call waiting Internet server (215) can be used to provide the incoming call information to the user's computer terminal (130). The call waiting system (220) further allows the user (205) to answer incoming calls in real-time when connected to the Internet (120) and return unsuccessful incoming call attempts at a later time.

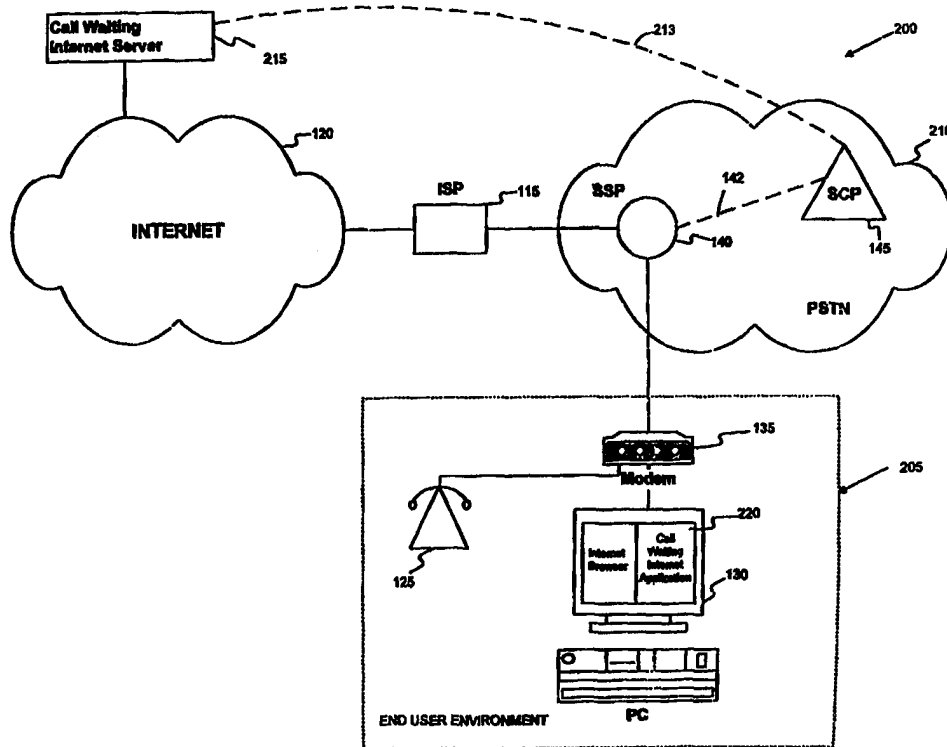

**FOR THE PURPOSES OF INFORMATION ONLY**

Codes used to identify States party to the PCT on the front pages of pamphlets publishing international applications under the PCT.

<b>AL</b>	Albania	<b>ES</b>	Spain	<b>LS</b>	Lesotho	<b>SI</b>	Slovenia
<b>AM</b>	Armenia	<b>FI</b>	Finland	<b>LT</b>	Lithuania	<b>SK</b>	Slovakia
<b>AT</b>	Austria	<b>FR</b>	France	<b>LU</b>	Luxembourg	<b>SN</b>	Senegal
<b>AU</b>	Australia	<b>GA</b>	Gabon	<b>LV</b>	Latvia	<b>SZ</b>	Swaziland
<b>AZ</b>	Azerbaijan	<b>GB</b>	United Kingdom	<b>MC</b>	Monaco	<b>TD</b>	Chad
<b>BA</b>	Bosnia and Herzegovina	<b>GE</b>	Georgia	<b>MD</b>	Republic of Moldova	<b>TG</b>	Togo
<b>BB</b>	Barbados	<b>GH</b>	Ghana	<b>MG</b>	Madagascar	<b>TJ</b>	Tajikistan
<b>BE</b>	Belgium	<b>GN</b>	Guinea	<b>MK</b>	The former Yugoslav Republic of Macedonia	<b>TM</b>	Turkmenistan
<b>BF</b>	Burkina Faso	<b>GR</b>	Greece			<b>TR</b>	Turkey
<b>BG</b>	Bulgaria	<b>HU</b>	Hungary	<b>ML</b>	Mali	<b>TT</b>	Trinidad and Tobago
<b>BJ</b>	Benin	<b>IE</b>	Ireland	<b>MN</b>	Mongolia	<b>UA</b>	Ukraine
<b>BR</b>	Brazil	<b>IL</b>	Israel	<b>MR</b>	Mauritania	<b>UG</b>	Uganda
<b>BY</b>	Belarus	<b>IS</b>	Iceland	<b>MW</b>	Malawi	<b>US</b>	United States of America
<b>CA</b>	Canada	<b>IT</b>	Italy	<b>MX</b>	Mexico	<b>UZ</b>	Uzbekistan
<b>CF</b>	Central African Republic	<b>JP</b>	Japan	<b>NE</b>	Niger	<b>VN</b>	Viet Nam
<b>CG</b>	Congo	<b>KE</b>	Kenya	<b>NL</b>	Netherlands	<b>YU</b>	Yugoslavia
<b>CH</b>	Switzerland	<b>KG</b>	Kyrgyzstan	<b>NO</b>	Norway	<b>ZW</b>	Zimbabwe
<b>CI</b>	Côte d'Ivoire	<b>KP</b>	Democratic People's Republic of Korea	<b>NZ</b>	New Zealand		
<b>CM</b>	Cameroon		Republic of Korea	<b>PL</b>	Poland		
<b>CN</b>	China	<b>KR</b>	Republic of Korea	<b>PT</b>	Portugal		
<b>CU</b>	Cuba	<b>KZ</b>	Kazakstan	<b>RO</b>	Romania		
<b>CZ</b>	Czech Republic	<b>LC</b>	Saint Lucia	<b>RU</b>	Russian Federation		
<b>DE</b>	Germany	<b>LI</b>	Liechtenstein	<b>SD</b>	Sudan		
<b>DK</b>	Denmark	<b>LK</b>	Sri Lanka	<b>SE</b>	Sweden		
<b>EE</b>	Estonia	<b>LR</b>	Liberia	<b>SG</b>	Singapore		

## SYSTEM AND METHOD FOR IMPLEMENTING CALL WAITING FUNCTIONS OVER A NETWORK

### Background of the Invention

The present invention relates generally to implementing service functions over a network, and more particularly to a call waiting service implemented over a telephone network which allows a user, such as an Internet user, to receive incoming call information from a third party without interrupting an active connection between the user and a second party.

Currently, telephone users have the option of subscribing to a call waiting service through their local telephone company. When a third party attempts to contact a telephone user that is actively connected to a second party, this service provides a tone signal to the user notifying her of the incoming call. The user may ignore the tone signal or switch over to the incoming call. Although the user is notified of an incoming call immediately, current call waiting services are highly intrusive and unreasonably disruptive to the telephone user. If the user ignores the tone signal, the missed caller remains unknown. Certain phone systems allow a user to input a specific code to automatically dial the telephone number of the person making the last incoming call attempt. This feature, however, is useless if more than one person attempted to call the user during their telephone conversation with the second party.

With the emergence of the Internet, more people are relying on a single dial-up telephone line to make voice calls and access the Internet. These users currently have a choice of either disabling call waiting on the Internet access line and potentially missing incoming calls or leaving the call waiting service active and taking a risk that the Internet session will be abruptly terminated by an incoming call. Certainly, many telephone and Internet users would find these results unacceptable.

Therefore, it is desirable to provide a call waiting system for telephone users who do not want to miss incoming calls and at the same time do not like to be interrupted with new calls during a telephone conversation with another person.

In addition, it is desirable to provide a call waiting system that allows Internet users to have an uninterrupted Internet session and at the same time not miss incoming calls.

Additional objectives, features and advantages of the invention will be set forth in the description which follows, and in part will be apparent from the description, or may be learned by practice of the invention. The objectives and other advantages of the invention will be realized and attained by means of the instrumentalities and combinations particularly pointed out in the written description and appended claims hereof as well as the appended drawings.

#### Description of the Invention

Systems and methods consistent with the present invention implement call waiting service functions over a telephone network allowing a user, such as an Internet user, to receive incoming call information from a third party without interrupting an active connection with a second party.

To achieve the objects and in accordance with the purposes of the invention, as embodied and broadly described herein, the invention comprises a system for implementing call waiting functions over a telephone network including a connecting means, activating means, notifying means, and providing means. Connecting means connect a user to a specified destination over the telephone network. Activating means activate a call waiting service available to the user. Notifying means notify the user about an incoming call attempt. Finally, providing means provide the user with information about the incoming call attempts without interrupting the connection between the user and specified destination.

A method for implementing call waiting functions over a telephone network, comprises several steps. Initially, a user is connected to a specified destination over the telephone network. A call waiting service available to the user is then activated and the user is notified about an incoming call attempt. Finally, the user is provided with information about the incoming call attempts without interrupting the connection between the user and specified destination.

It is to be understood that both the foregoing general description and the following detailed description are exemplary and explanatory only and are not restrictive of the invention, as claimed.

#### Brief Description of the Drawings

The accompanying drawings, which are incorporated in and constitute a part of the specification, illustrate the invention and together with the description, serve to explain the principles of the invention.

In the drawings,

Fig. 1 shows a telephone network architecture which supports a call waiting system consistent with the present invention;

Fig. 2 shows an Internet network architecture which supports a call waiting system consistent with the present invention;

Fig. 3a shows a flowchart for activating the call waiting system;

Fig. 3b shows a service logic program (SLP) for activating a call waiting flag consistent with a step of Fig. 3a;

Fig. 3c shows a SLP for providing a termination notification message consistent with a step of Fig. 3a;

Fig. 3d shows a SLP for updating service control point status consistent with a step of Fig. 3a;

Fig. 4a shows a flowchart for deactivating a call waiting system;

Fig. 4b shows a SLP for deactivating a call waiting flag consistent with a step of Fig. 4a;

Fig. 4c shows a SLP for updating service control point status consistent with a step of Fig. 4a;

Fig. 5a shows a flowchart for routing new incoming calls to voice mail over the telephone network architecture of Fig. 1;

Fig. 5b shows a SLP for activating voice mail services consistent with a step of Fig. 5a;

Fig. 5c shows a SLP for updating a voice mail message consistent with a step of Fig. 5a;

Fig. 6a shows a flowchart for routing and displaying incoming call information at the site of a user over the Internet network architecture of Fig. 2;

Fig. 6b shows a SLP for determining appropriate action for third party call consistent with a step of Fig. 6a;

Fig. 6c shows a SLP for generating a table including calling party's name and telephone number consistent with a step of Fig. 6a;

Fig. 6d shows a SLP for sending the calling party's name and telephone number to a call waiting server consistent with a step of Fig. 6a;

Fig. 7 shows a block diagram of the features available on the call waiting system consistent with the present invention;

Fig. 8 shows a flowchart of a call waiting system package available to users over the telephone network architecture of Fig. 1; and

Fig. 9 shows a flowchart of a call waiting system package available to users over the Internet network architecture of Fig. 2.

### Best Mode for Carrying Out the Invention

Reference will now be made in detail to the present preferred embodiments of the invention, examples of which are illustrated in the accompanying drawings. Wherever possible, the same reference numbers will be used throughout the drawings to refer to the same or like parts.

Fig. 1 illustrates a telephone network architecture for implementing call service functions consistent with the present invention. Telephone network architecture 100 includes an end user environment 105, a public switch telephone network (PSTN) 110, an Internet Service Provider (ISP) 115 (e.g., America On-line), and Internet 120.

End user environment 105 includes a telephone 125, personal computer 130 and modem 135. To make a voice call, an end user uses telephone 125 to manually dial the telephone number of the destination terminal. However, when the end user wishes to send and receive data (e.g., via Internet 120), modem 135 is utilized for such a connection. To facilitate an Internet connection through modem 135 and ISP 115, the end user typically uses Internet browsing software, such as Netscape Navigator™ or Microsoft Explorer™. Whether the end user is attempting to make a voice connection or a modem connection, each telephone number dialed from end user environment 105 is sent to PSTN 110 over telephone line 136. Although telephone 125 is shown connected to modem 135 to access telephone line 136 in Fig. 1, end user environment 105 is not limited to this configuration. For example, telephone 125 may be directly connected to telephone line 136.

PSTN 110 includes a service switching point (SSP) 140, a service control point (SCP) 145 and a voice mail system 150. Signals sent from end user environment 105 first arrive at SSP 140, typically a local telephone company, which analyzes the signals and determines where to route the call. For example, depending on the telephone number dialed, SSP 140 may route the call immediately over PSTN 110 to attempt a connection or communicate with SCP 145 over link 142 for further routing information.

SCP 145 controls the transfer of information signals between nodes (e.g., SSP 140 and voice mail system 150) on telephone network architecture 100 and preferably comprises a Bellcore ISCP® platform architecture to create and execute network services including, for example, the SPACE® and MSAP™ applications.

Voice mail system 150 communicates with SSP 140 over communication links 151 and 152 and communicates with SCP 145 over communication link 147 to effectively provide voice mail services to users of PSTN 110. Communication links 147 and 151 are preferably wireless communication channels for transferring information. Voice mail system 150 operates to record voice messages for call waiting service subscribers.

ISP 115 is connected to SSP 140 over communication link 116. ISP 115 supports multiple users who subscribe thereto for Internet access. ISP 115 may provide subscribers with additional services such as e-mail and searching functions.

Fig. 2 illustrates an Internet network architecture 200 similar to that disclosed in Fig. 1. In particular, Internet network architecture 200 includes ISP 115 and Internet 120, both illustrated in Fig. 1. In addition to these elements, however, Internet network architecture 200 includes an end user environment 205, PSTN 210, and call waiting Internet server 215.

End user environment 205 is updated to include a call waiting Internet application 220 which is a software program executed by PC 130 for providing an end user with a variety of call waiting features specific to Internet applications. Calls from end user environment 205 attempting to connect with ISP 115 are routed over PSTN 210 which, in one embodiment, may not include dedicated voice mail system 150 illustrated in Fig. 1. SCP 145 communicates with SSP 140 over communication link 142 and call waiting Internet server 215 over communication link 213. Call waiting Internet server 214 is a computer server dedicated to managing call waiting functions over Internet 120. Call waiting Internet server 215 communicates with Internet 120 using standard transmission control protocol and Internet protocol (TCP/IP). Call waiting Internet application 220 software may be downloaded from ISP 115, call waiting Internet server 215, or provided on storage media (e.g., diskette or CD-ROM) to the user. When executed, the software retrieves information about incoming calls from call waiting Internet server using address-specific or "PUSH" technology.

Call waiting activation over the network architecture described above is illustrated in the flowchart of Fig. 3a. References to Fig. 1 components are provided. Initially, an end user dials ISP's 115 telephone number (step 300). An information signal including the user's ten-digit

telephone number is sent to SSP 140 where the information signal is analyzed and routed to SCP 145 (step 320). Upon reaching SCP 145, a service logic program (SLP) corresponding to the information signal is executed (step 340). Figs. 3b-3d, 4b-4c, 5b-5c, and 6b-6d are examples of SLPs executed in the SPACE® application for a Call Waiting DeLuxe Service<sup>SM</sup> also developed by Bellcore. For this application, SLPs are referred to as call processing records (CPRs).

In Fig. 3b, a CPR for activating call waiting is illustrated. First, the information signal is analyzed (step 340a) and the CPR attempts to load a call waiting flag corresponding to the user's record (steps 340b and 340c). An unsuccessful load attempt indicates that the user does not subscribe to the Call Waiting DeLuxe Service<sup>SM</sup> and the call is routed to ISP 115 (step 340d). If the call waiting flag loads successfully, then the flag is activated (i.e., set to "yes") (step 340e). At this point, the CPR activates (i.e., turns on) a termination notification message for the user as illustrated in Fig. 3c (step 340f). In this figure, a termination notification window 341 is displayed allowing entry of a termination notification ID (i.e., user's telephone number). Subsequently, the CPR activates a termination attempt trigger to notify the user of an incoming call while in communication with ISP 115 as illustrated in Fig. 3d (step 340g). Termination attempt window 342 and select trigger window 343 are provided to select the indicated active termination attempt parameters. Upon activating the termination attempt trigger, the CPR saves the modifications (step 340h) and routes the call to the ISP (step 340i). Upon connecting with ISP 115, the call is established (step 360 of Fig. 3a), creating an active connection between the user and ISP 115 (step 370). Finally, the user's Internet protocol (IP) address is registered with



call waiting Internet server 215 to activate call waiting services (step 380). By activating the call waiting feature consistent with the present invention, a user can receive incoming call information from a third party while connected to ISP 115.

The call waiting service as described herein may also be deactivated if a user chooses not to receive any incoming call information while connected to ISP 115. Fig. 4a provides a flowchart for deactivating the call waiting system consistent with the present invention. Initially, the user hangs up the telephone or otherwise terminates the telephone call (e.g., such as when exiting an Internet browser) (step 400). At this stage, SSP 140 sends a notification signal to SCP 145 indicating that the user has terminated the call (step 420). In response to the notification, SCP 145 executes a SLP or CPR to deactivate call waiting (step 440), as provided in Figs. 4b-4c.

In Fig. 4b, the CPR analyzes the user's record (step 440a) and determines whether call waiting is active (step 440b). If call waiting flag is not active, CPR execution stops (step 440c). Otherwise, the call waiting flag is deactivated (i.e., turned off) (step 440d) and the user's telephone number is assigned to a temporary variable (step 440e). Subsequently, the termination attempt trigger status is updated (i.e., deactivated), as illustrated in Fig. 4c (step 440f). In this figure, termination attempt window 441 and select trigger window 442 are provided to select the indicated inactive termination attempt parameters. Upon deactivating the termination attempt trigger, the CPR saves the modifications (step 440g) and stops (step 440h). Finally, after completion of the CPR, the call is terminated (step 460 of Fig. 4a).

When the call waiting service of the present invention is active and a communication link is established between the user and ISP, for example, any new incoming calls to the user may be routed to voice mail system 150 illustrated in Fig. 1. The process of routing new incoming calls to voice mail system 150 is illustrated in the flowchart of Fig. 5a. First, during active communications between a user and ISP (step 500), a new caller dials the user's telephone number (step 520). At this point, a termination attempt signal is sent from the new caller's SSP to the SCP (step 540). The SCP executes a CPR requesting the new caller's SSP to activate a message waiting indicator and route the call to voice mail system 150 (step 560). Alternatively, the call can be routed to another telephone number (e.g., a second phone line at the user's location).

Figs. 5b-5c illustrate the CPR for executing the voice mail system features consistent with the present invention. First, the CPR analyzes the record of the person called (i.e., end user connected to ISP) (step 560a) and determines if call waiting is activated (step 560b). If call

waiting is not activated, CPR execution stops, and the call is routed back to the new caller's SSP (step 560c). If call waiting is active, the CPR activates a message waiting indicator, as illustrated in Fig. 5c. In this Figure, a message waiting indicator window 561 is activated to allow the system operator to enter the identified message waiting indicator parameters. Upon activating the message waiting indicator, a voice mail routing number is specified (step 560e) and the call is routed to voice mail (step 560f) over line 147 of Fig. 1. At this point, a call is established between the new caller and the user's voice mail so that the new caller may leave a message for the user for subsequent retrieval (step 580). Therefore, a user will not miss any new incoming calls while connected to a second party (e.g., an ISP).

Fig. 6a shows a flowchart for routing and displaying incoming call information at the site of a user over the Internet network architecture of Fig. 2. Initially, a new caller dials the user's telephone number (step 600) and a termination attempt signal is routed from the new caller's SSP (which may be SSP 140) to SCP 145 (step 620). Subsequently, SCP 145 executes a CPR to obtain the calling party's name, send the calling party's name and number to the call waiting server, and play an announcement to the calling party (step 640). Exemplary CPRs for executing step 640 are illustrated in Figs. 6b-6d.

In Fig. 6b, the CPR analyzes the record of the person called (i.e., user connected to ISP) (step 640a) and determines if call waiting is activated (i.e., call waiting flag is set). If the flag is not active, then the call is routed back to the new caller's SSP. If the flag is active, then the CPR retrieves the caller's name and telephone number by activating a table function illustrated in Fig. 6c (step 640d). Table 641 allows a system operator to view parameters indicating whether the caller's name and telephone number are successfully retrieved. If so, the CPR activates a send data window 642, illustrated in Fig. 6d, that allows the system operator to view the parameters associated with sending the data (step 640e). Finally, the caller's name and telephone number are sent to the call waiting server and an announcement is played to the caller (step 640f).

Referring back to Fig. 6a, the caller's information is then sent from call waiting Internet server 215 to the user's personal computer which has an active connection with the ISP (step 650). The call waiting Internet application software residing in the PC of the user, then displays the caller's information on the display screen of the PC (step 660). At this time, the user is able to review the caller's information in real-time and decide whether to answer the call or wait until after their Internet session. To answer the call, the end user environment must be equipped to accept voice signals while connected to the Internet. If the user chooses not to answer the

incoming call (e.g., by selecting "NO" on the screen or ignoring the caller information), call waiting Internet server 215 signals SCP 145 indicating that the call will not be accepted. Subsequently, SCP 145 sends a message to the new caller's SSP requesting that the call be blocked from connecting to the end user (step 670). In response to this message, the caller's SSP sends a busy tone to the caller (step 680). The advantage of this system is that the user has the ability to review the incoming call information in real-time and decide when to return the incoming call.

Fig. 7 shows a block diagram of the configurable features available on the call waiting system consistent with the present invention. Each feature provides the user with convenience options so that the call waiting service can be customized for different users. These features may be implemented by one or more of the network architecture component described above. For call waiting service activation (block 700), the user has the options of activating the service only for the duration of the next call made by the user (block 702), automatically activating the service during telephone calls to specific numbers (block 704), or allowing the service to be active all of the time (block 706). The next feature of the call waiting service includes options for notifying a user about incoming calls (block 710). For this feature, the user may be notified about incoming calls from a third party while a call between the user and the second party is still in progress (block 712). In addition, the user has the option of being notified about missed calls from third parties after the termination of the active call between the user and the second party (block 714). Moreover, the user has options for receiving indications of the missed calls (block 720). The first option allows the user to dial a special telephone number or feature code to retrieve incoming call information (block 722). Alternatively, the user may implement an Internet application to make an explicit request to retrieve incoming call information. The user may also be provided with information without an explicit request (block 724). For this option, information delivery can be based on an Internet application which automatically displays information as soon as it becomes available to the user.

The user may also control the amount of information they receive about a missed incoming call (block 730). This information may include a caller's telephone number, the time and date of an incoming call, the caller's name, and a voice message from the caller (block 732). The way incoming calls are answered may also be controlled by the user (block 740). For this particular feature of the present invention, the user may have the option of answering the call in real-time (block 742) or no ability to answer the incoming call in real-time (block 744). Finally,

if the user wishes to return a missed call, the user also has available options (block 750). The options include allowing the network to assist the user by automatically dialing the telephone number of the missed caller (block 752) or requiring the user to explicitly dial the telephone number herself (block 754).

Fig. 8 shows a flowchart of a pre-configured call waiting system package available to users over the telephone network architecture of Fig. 1. This call waiting system package is preferably customized for particular service requirements and automatically activates the call waiting service when the user calls one or more specific telephone numbers, such as different ISPs telephone numbers (step 800). Any incoming calls received by the user while connected to the ISP are routed to the voice mail system and the user is notified of the missed call after logging off from the ISP (step 810). The user is then able to retrieve the missed call information by calling a special voice mail telephone number (step 820). Upon calling the special telephone number, the user is provided with the time and date of the call, the caller's telephone number, the name of the caller, and a voice message from the caller (step 830). With this particular call waiting package, the user is not able to answer incoming calls in real-time (step 840). However, the user can explicitly dial the telephone number of the caller when returning the missed calls (step 850).

Fig. 9 illustrates an alternative enablement of a call waiting system package. For this call waiting package, the user automatically activates the call waiting service when calling predetermined telephone numbers (step 900). When a third party attempts to call the user, an Internet application implemented by the user's PC may be utilized to find out information about the missed call (step 910). The Internet application may be used and programmed to automatically display the missed call information as soon as it is available to the user (step 920). The system then provides the user with the time and date of the call, the caller's telephone number, and the caller's name (step 930). With the second call waiting system package, the user is also not able to answer incoming calls in real-time (step 940). As with the first call waiting system package, however, the user can explicitly dial the telephone number of the caller when returning the missed calls (step 950).

The call waiting system discussed herein provides a user with a variety of options for receiving incoming call information without interrupting an active connection with a second party. The call waiting system is less intrusive than conventional call waiting services in that the user has complete control over when to receive, review, and return missed incoming calls.

Moreover, the call waiting Internet application feature is unprecedented and adds versatility to other features of the call waiting system. For example, the user can view information from each and every incoming call shortly after the call is made. This feature gives the user the flexibility of returning an important telephone call immediately as opposed to missing the call entirely or waiting until the Internet session has ended.

While there has been illustrated and described what are at present considered to be preferred embodiments and methods of the present invention, it will be understood by those skilled in the art that various changes and modifications may be made, and equivalents may be substituted for elements thereof without departing from the true scope of the invention.

In addition, many modifications may be made to adapt a particular element, technique or implementation to the teachings of the present invention without departing from the central scope of the invention. Therefore, it is intended that this invention not be limited to the particular embodiments and methods disclosed herein, but that the invention include all embodiments falling within the scope of the appended claims.

Claims

1. A system for implementing call waiting functions over a telephone network, comprising:  
means for connecting a user to a specified destination over the telephone network;  
means for activating a call waiting service available to the user over the network;  
means for notifying the user about an incoming call attempt; and  
means for providing the user with information about the incoming call attempts  
without interrupting the connection between the user and specified destination.
2. The system of claim 1, further comprising means for receiving an indication of the number of incoming call attempts.
3. The system of claim 1, further comprising means for answering the incoming call attempts when the user is connected to the specified destination over the telephone network.
4. The system of claim 1, further comprising means for returning the call of a person making the incoming call attempts.
5. A telephone network connected to the Internet, comprising:  
an end user environment in communication with the Internet over the telephone network;  
a service switching point;  
a voice mail system in communication with the service switching point; and  
a service control point in communication with the service switching point and voice mail  
system for implementing call waiting functions to allow the end user environment to receive incoming call information while in communication with the Internet.
6. The system of claim 5, further comprising a call waiting Internet server which provides incoming call information to the end user environment.
7. A service control point in communication with the Internet, comprising:  
means for receiving telephone call information;

means for modifying the activation status of a call waiting service in response to the telephone call information; and

means for routing the telephone call information to a predetermined destination over the Internet.

8. A call waiting Internet server connected to a network, comprising:
  - means for receiving telephone call information over the network; and
  - means for providing the telephone call information to a user actively connected to the Internet, without interruption of service.
  
9. A method for implementing call waiting functions over a telephone network, comprising the steps of:
  - connecting a user to a specified destination over the telephone network;
  - activating a call waiting service available to the user;
  - notifying the user about an incoming call attempt;
  - providing the user with information about the incoming call attempt without interrupting the connection between the user and specified destination.
  
10. The method of claim 9 further comprising the step of receiving an indication of the number of the incoming call attempts.
  
11. The method of claim 9 further comprising the step of answering the incoming call attempt when the user is connected to the specified destination over the telephone network.
  
12. The method of claim 9 further comprising the step of returning the call of the person making the incoming call attempts.
  
13. The method of claim 9 wherein the activating step includes activating the call waiting service for the duration of the next call made by the user.
  
14. The method of claim 9 wherein the activating step includes activating the call waiting service automatically when a call is made to a specified telephone number.

15. The method of claim 9 wherein the notifying step includes the step of informing the user about the incoming call attempt when the user disconnects from the specified destination.
16. The method of claim 10 wherein the receiving step includes the step of manually dialing a specified telephone number to retrieve the number of incoming call attempts.
17. The method of claim 10 wherein the receiving step includes the step of utilizing an Internet-based application to request the information about the incoming call attempts.
18. The method of claim 11 wherein the answering step includes the step of responding to the incoming call attempt in real-time.



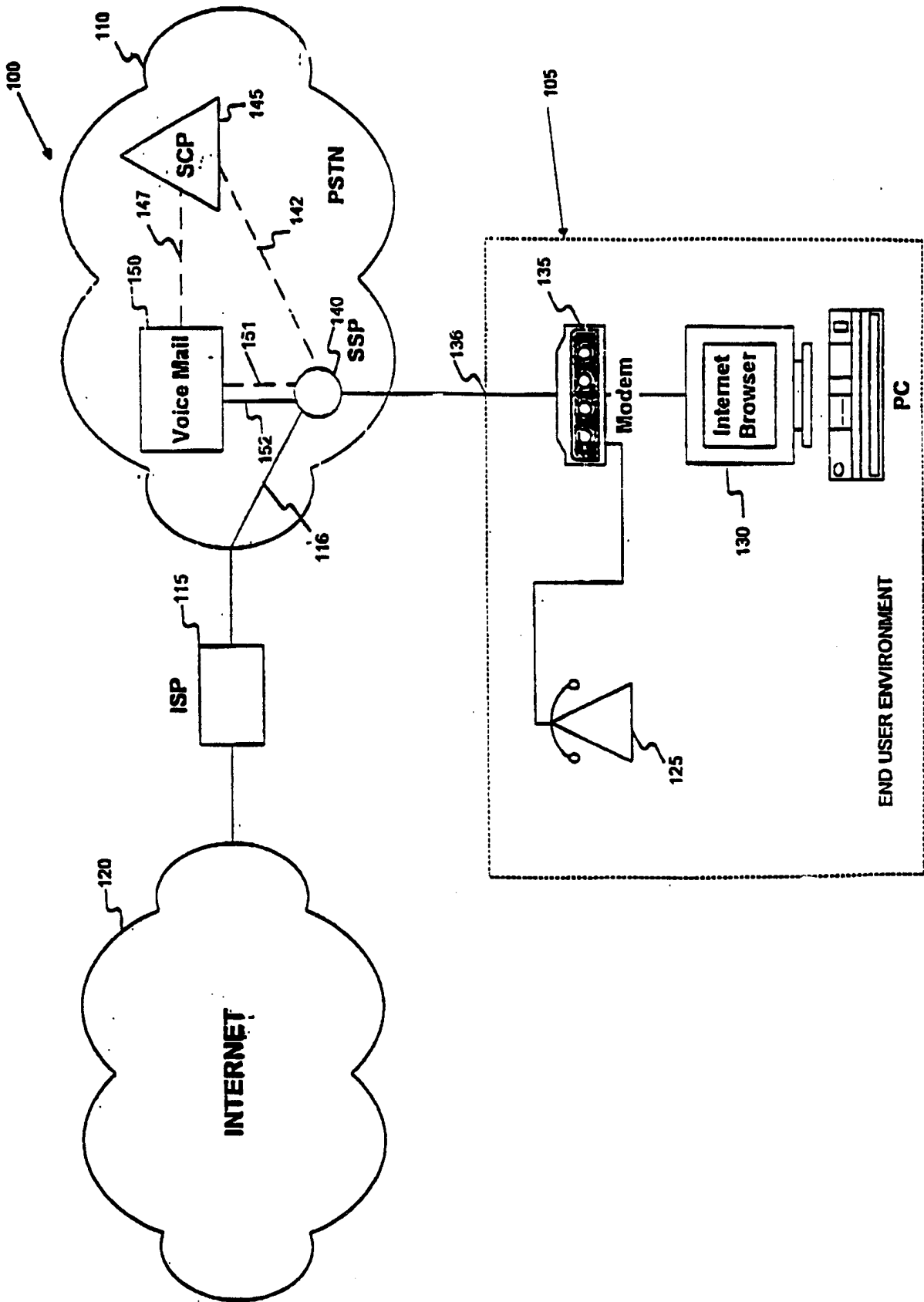

FIG. 1

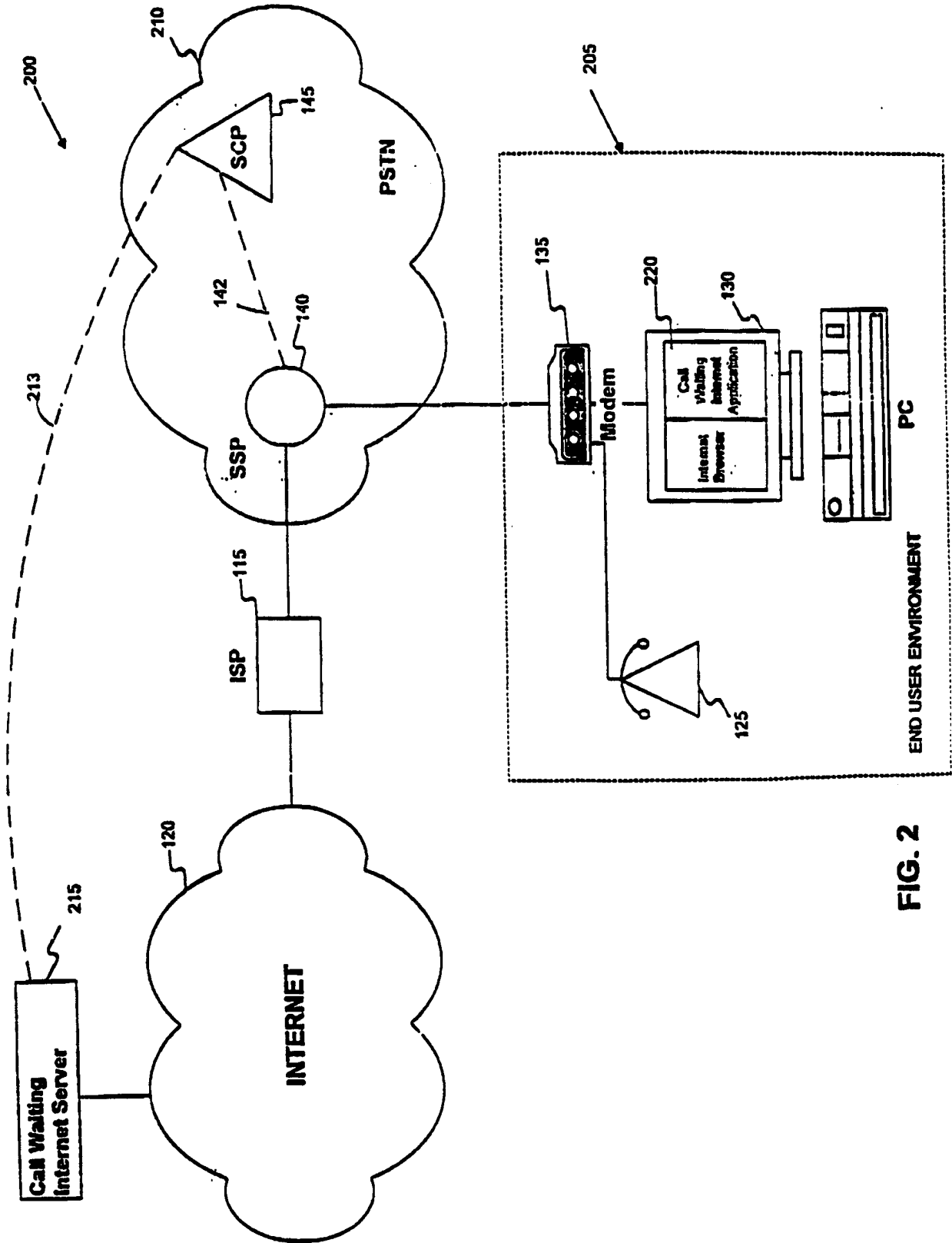

FIG. 2

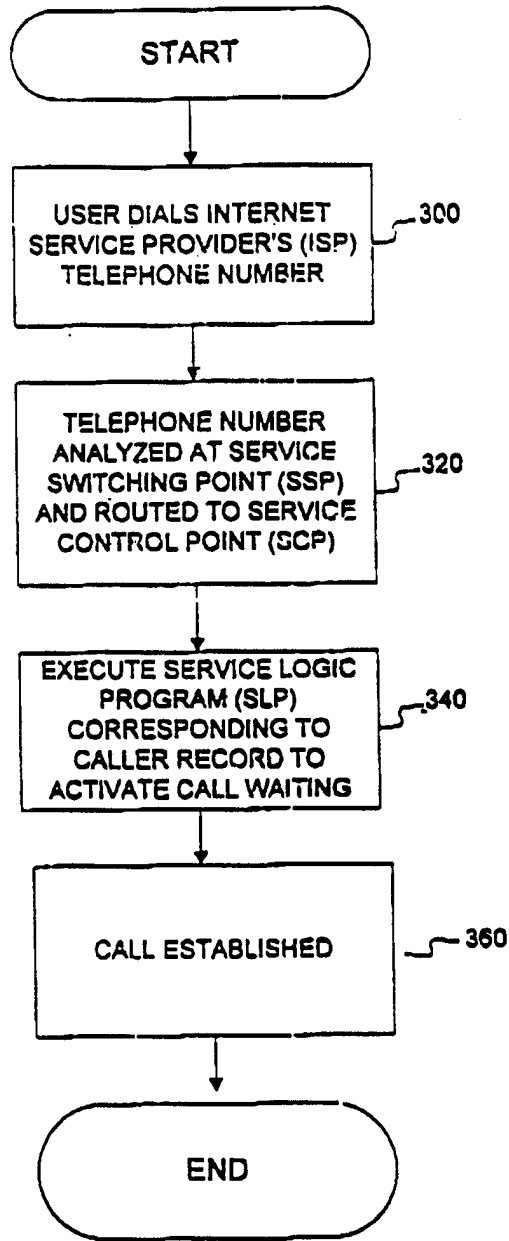

FIG. 3a

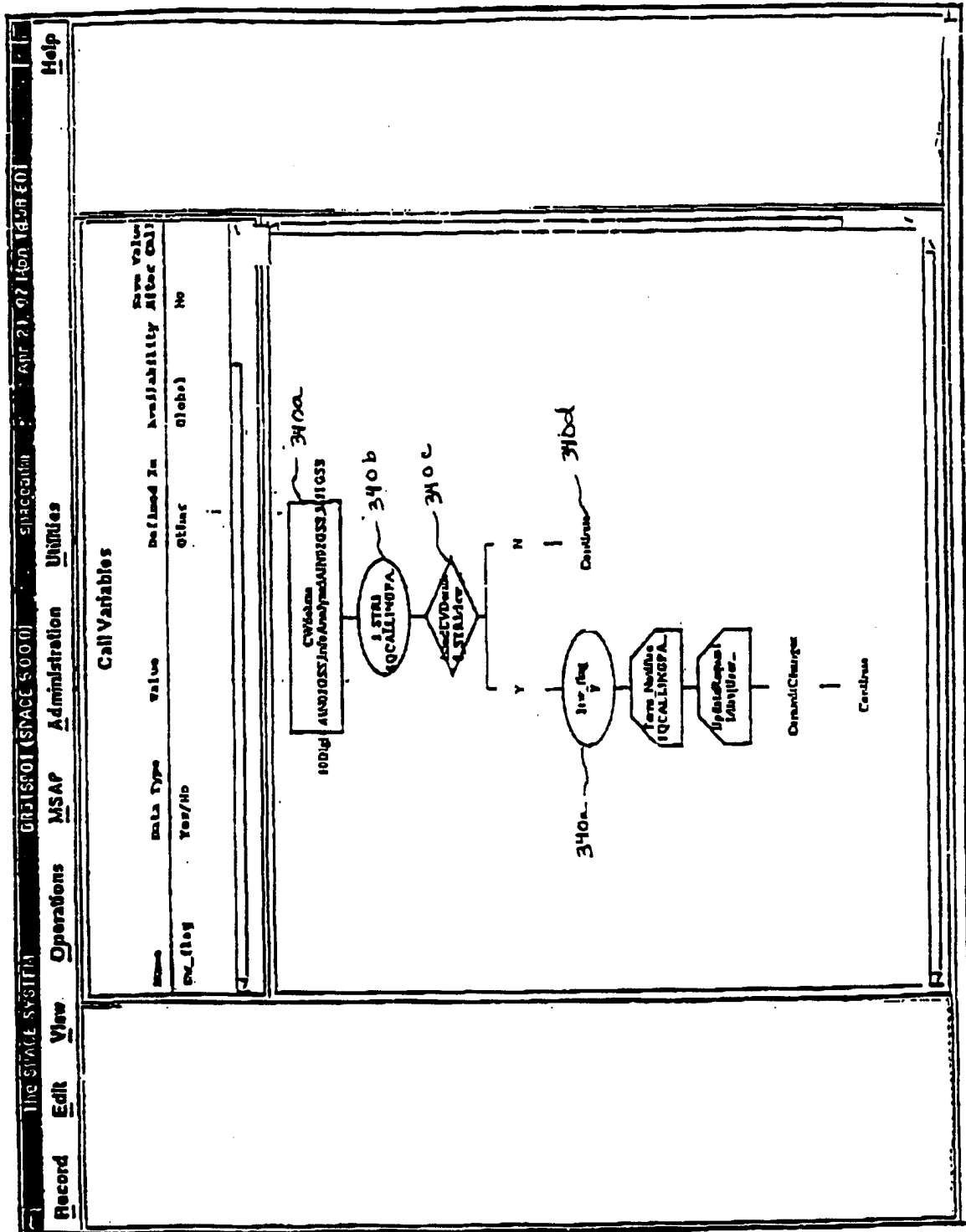

Fig. 3b

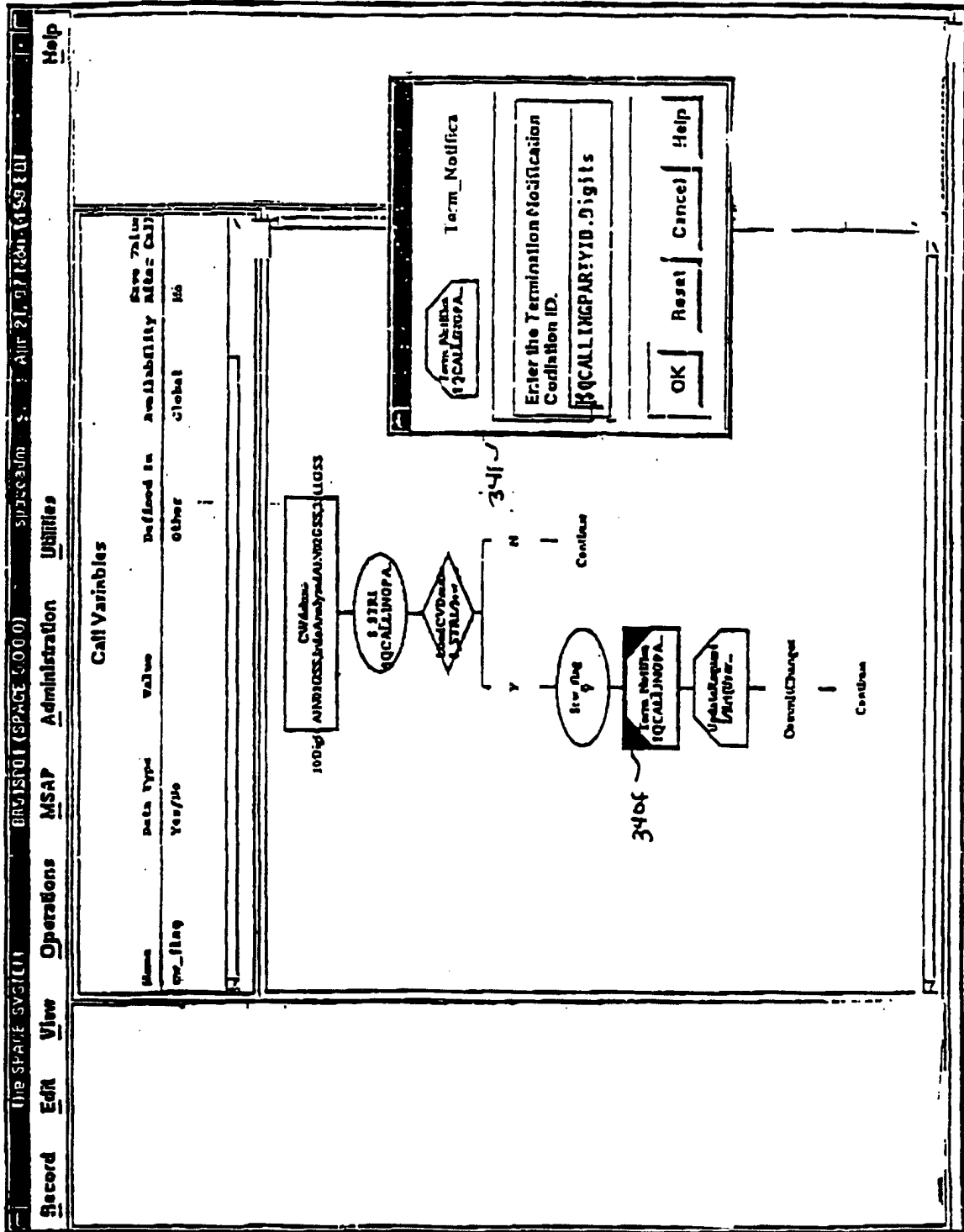

FIG. 3c

DETAILED VIEW (01/15/98) (SPACE 5000)

Record Edit View Operations MSAP Administration

Call Var.

Name	Data Type	Value
cc_flag	Yes/No	342

Update Request

Associated Wait for Event node Event ID

Select the User ID Type

Enter the User ID (Subscriber number) value

||| QCALLINGPARTYID-Digits

Enter the Service Profile (SP) ID value (Optional)

Select the Bearer Capability

||| speech

Enter the TriggerCriteriaFlag

||| TriggerCriteriaFlag(ActivateTr Show Details

Enter exactly one of the following

Enter either the Signaling Point Code destination

Or as NPANXX of the SSP (AIN switch)

||| telcomp(QCALLINGPARTYID, 2)

OK Reset Cancel Help

343

Select if trigger should be activated or deactivated

||| ActivateTrigger

Select the trigger

||| TerminationAttempt

OK Reset Cancel Help

344

Update Request

Enter the number of the trigger

||| 340h

Continue

345

Fig. 3d

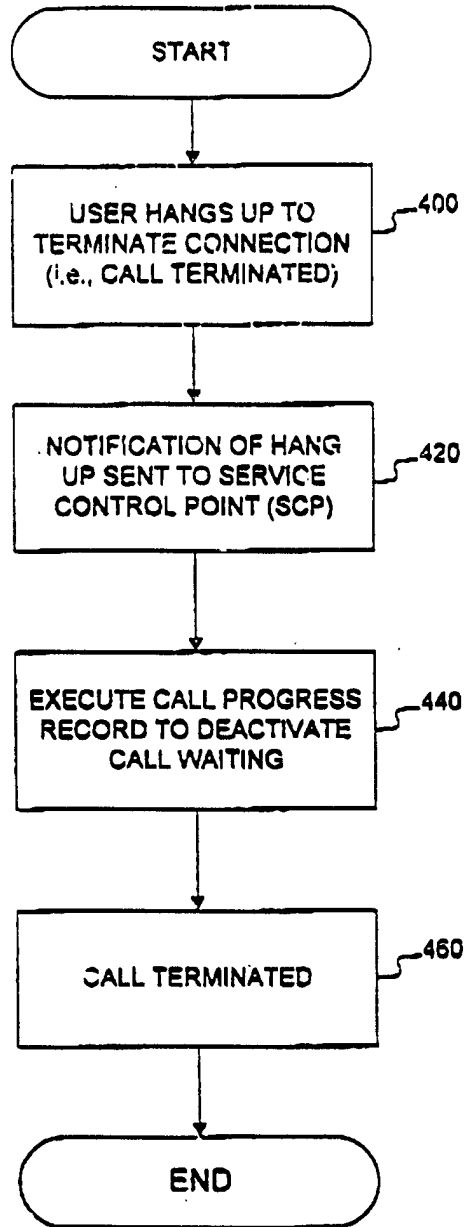

FIG. 4a

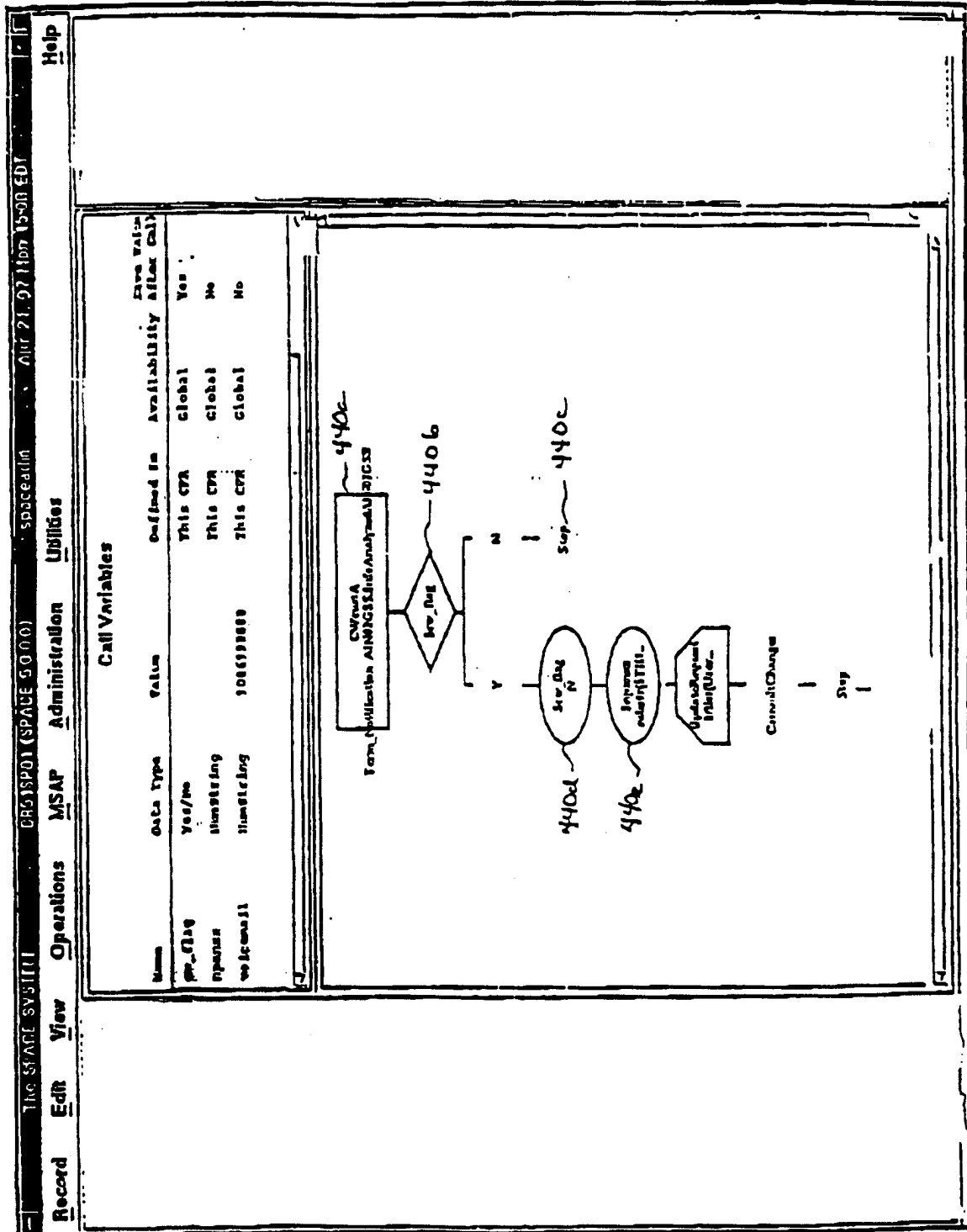

Fig. 4b



The SPACE SYSTEM    8101SPDI (SPACE 5000)    **Update Request**

Record    Edit    View    Operations    MSAP    Adminstrallion

Name	Data Type	Value
oc_flag	Yes/No	441
spname	String	
volcanol	String	306655000

Turn\_International\_Attempt    **442**

Service Profile    **443**

Update Request Subscriber    **444**

Capacity Charge    **445**

Update Request Subscriber    **446**

Capacity Charge    **447**

Update Request Subscriber    **448**

Capacity Charge    **449**

---

**Associated WaitForEvent node Event ID**

Select the UserID Type

Enter the UserID (Subscriber number) value

Enter the Service Profile (SP) ID value (Optional)

Select the Bearer Capability

Enter the TriggerCriteriaFlag

TriggerCriteriaFlag (Deactivate    Show Details)

Enter exactly one of the following

Enter either the Signaling Point Code destination

Or an NPANXX of the SSP (AIN switch)

OK    Reset    Cancel    Help

---

Select if trigger should be activated or deactivated

DeactivateTrigger

Select the trigger

TerminationAttempt

OK    Reset    Cancel    Help

Fig. 4c

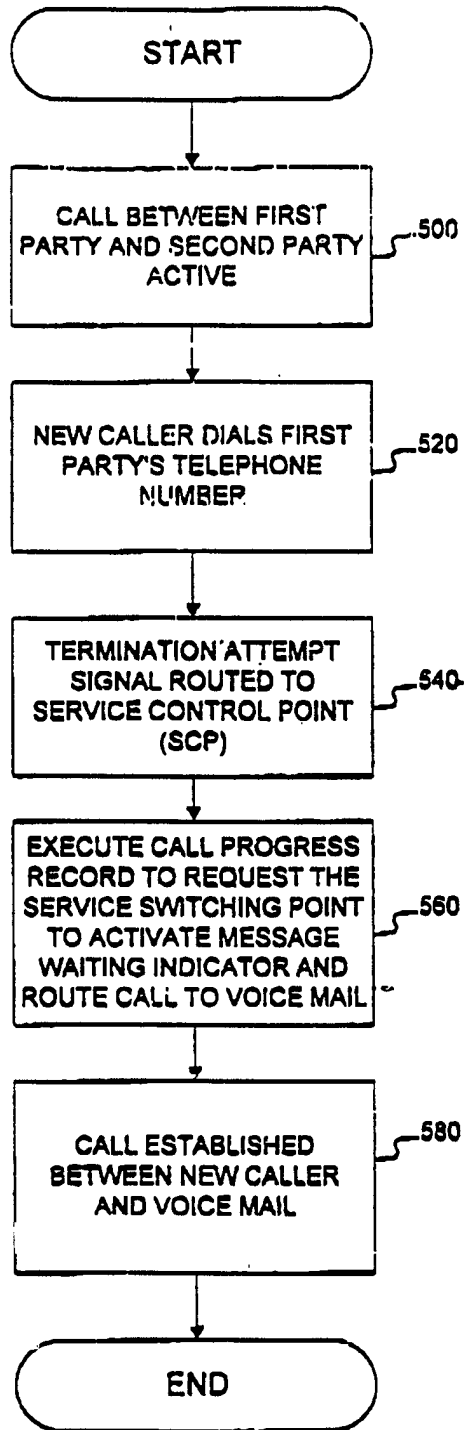

FIG. 5a

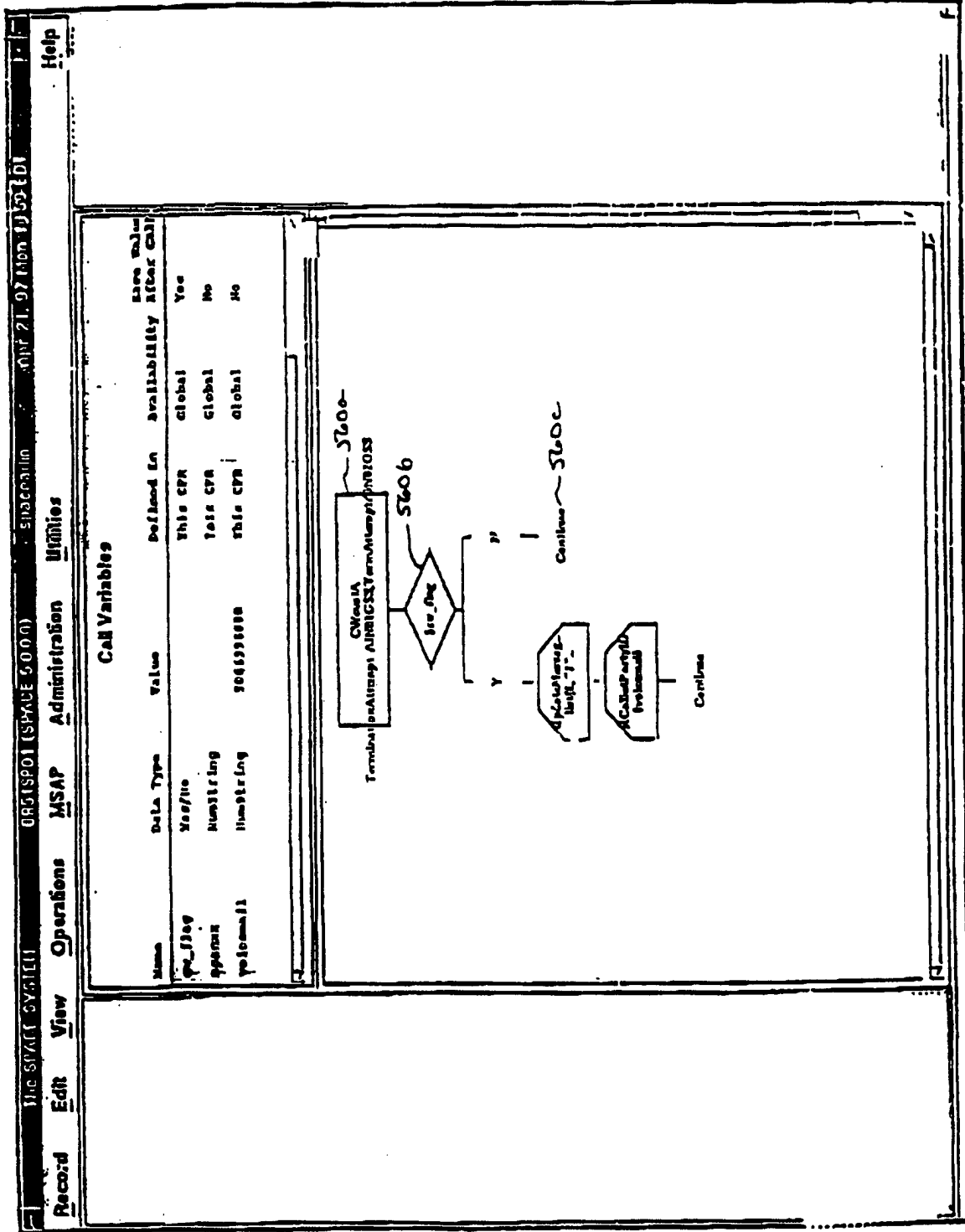

Fig. 5b

THE SPACE SYSTEM  
 BR3TSPDT (SPACE 6000)  
 Record Edit View Operations MSAP Administration

Update/Message Waitind

Name	Data Type	Value
see_flg	Yes/No	Stel
opnum	Number	
vsnum11	Number	1011111111

THIS CPR  
 Enter the 10 digit Directory Number  
 Specify Directory Number only  
 Specify Directory Number and Call Type

Enter the 10 digit Directory Number

Enter the Call Type

Enter the Activation State Code (optional)

Enter exactly one of the following

Enter either the Signaling Point Code destination

Or an NP ANXX of the SSP (ANX switch)

Or a comp (SQCALLEDPARTYID, 2)

OK
Reset
Cancel
Help

CWDATA  
 Update/Message Waitind ANX/SQ/ST/...

```

    graph TD
      Start([Start]) --> Update[Update/Message Waitind]
      Update --> Assign[Assign Party ID]
      Assign --> Continue([Continue])
      Update --> SeeFlg{see_flg}
      SeeFlg -- Y --> Update
      SeeFlg -- N --> Assign
    
```

SLOD  
 SLOZ  
 SLOF  
 Continue

Fig. 5c

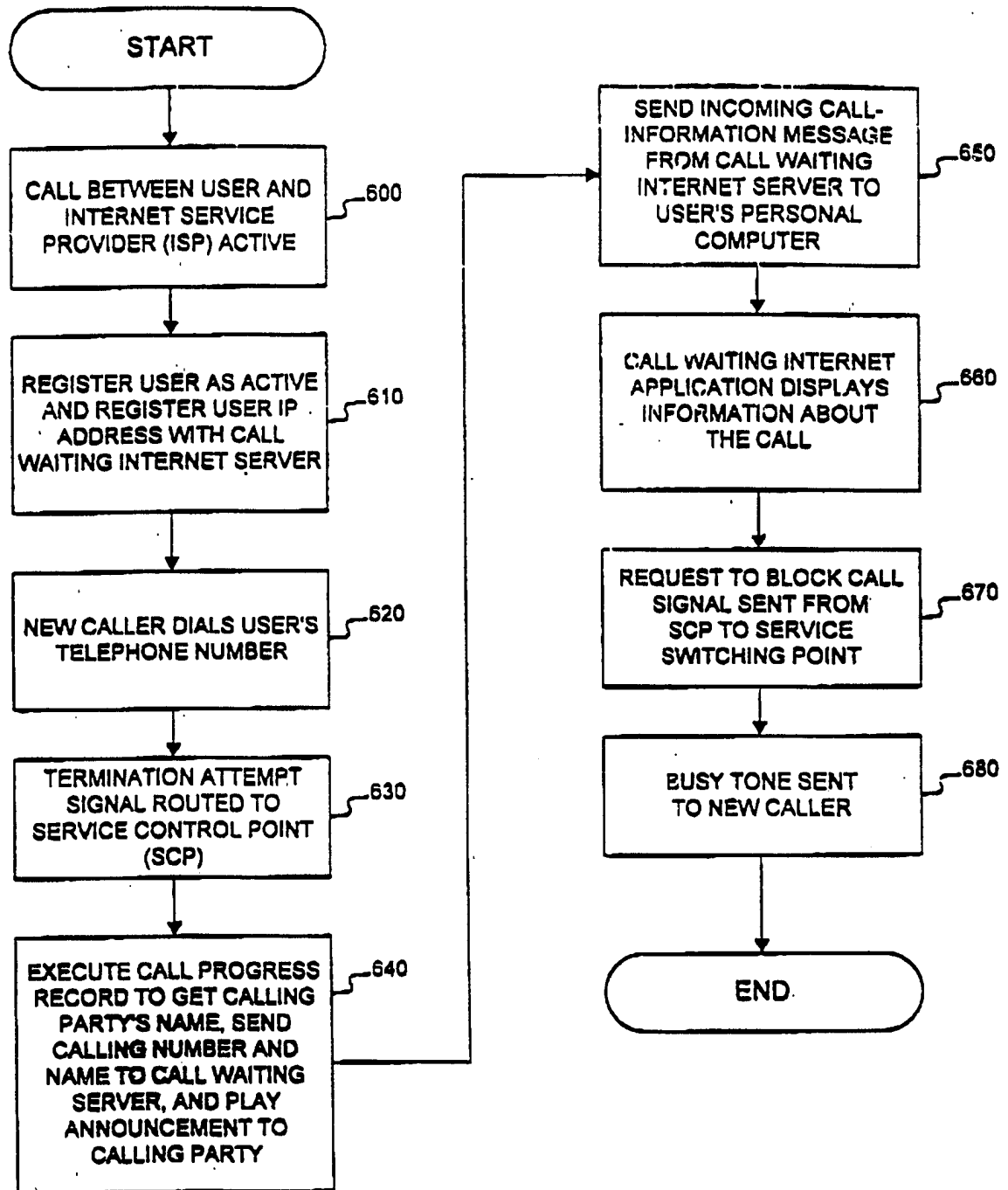

FIG. 6a

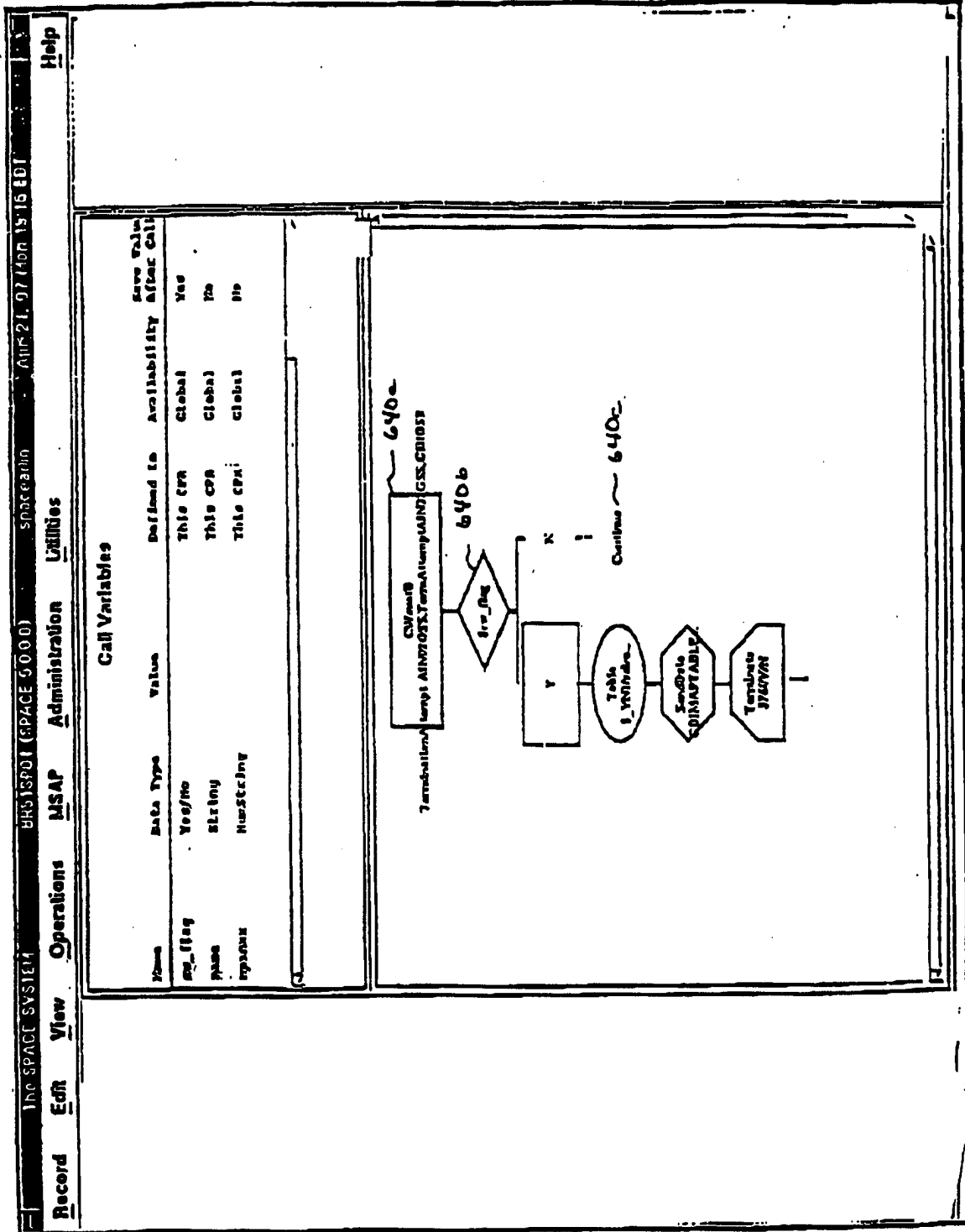

Fig. 6b

The SPACE SYSTEMS Administration

Record Edit View Operations MSAP Administration

Apr 21, 97 Mon 10:31:40

**CallVars**

Name	Data Type	Value
SP_Flag	Yes/No	
Name	String	641
operator	Numbering	

**Table**

Enter a yes/no call variable to indicate if the retrieve was successful

SP\_YHI

Enter table record search criteria

Table name: SP\_FlagName

Search matrix

- Search for the rows meeting ALL of the criteria
- Search for the rows meeting ANY of the criteria

Column name: Logarithm Value to be compared to

NUMBER1 SOCIALINTEGRATION.DIGITS

Retrieval matrix

Select the columns to retrieve data

Column name: Call variable name

NAME: SP\_YHI

640d

```

graph TD
    Start([Termination of Temp ALINTEGRATION]) --> Decision{SP_Flag}
    Decision -- Y --> Table([Table L_YHIName])
    Decision -- N --> End([Terminate 9767765])
    Table --> Step([Send Data COMINTEGRATION])
    Step --> End
  
```

OK    Reset    Cancel    Help

Fig. 6c

The SPACE SYSTEM      BR51SPDI (SPACE 5000)      AIR 21-97 Mon 05:17 EDT

Record   Edit   View   Operations   MSAP   Administration

SendData SendData

SendData SendData

Table Name (ISCP Tag-Table)  
 SENDDATA  
 SAVED

Associated Event ID  
 12

Access Key (external search key)  
 #THISCP#

Security ID (optional)

Guarantee send data (resend if unsuccessful)  
 No

Data to send  
 tag name      data to send  
 Calling\_Number      SENDDATA  
 Calling\_Name      name

OK      Reset      Cancel      Help

---

Car Varial      642

Name	Data Type	Value
CP_Flag	Yes/No	
Name	String	
System	String	

Termination      640e      640f

SendData SendData

Table s\_yml/ndr-      Termination STATION

Events      640e      640f

Termination      640e      640f

Fig. 6d



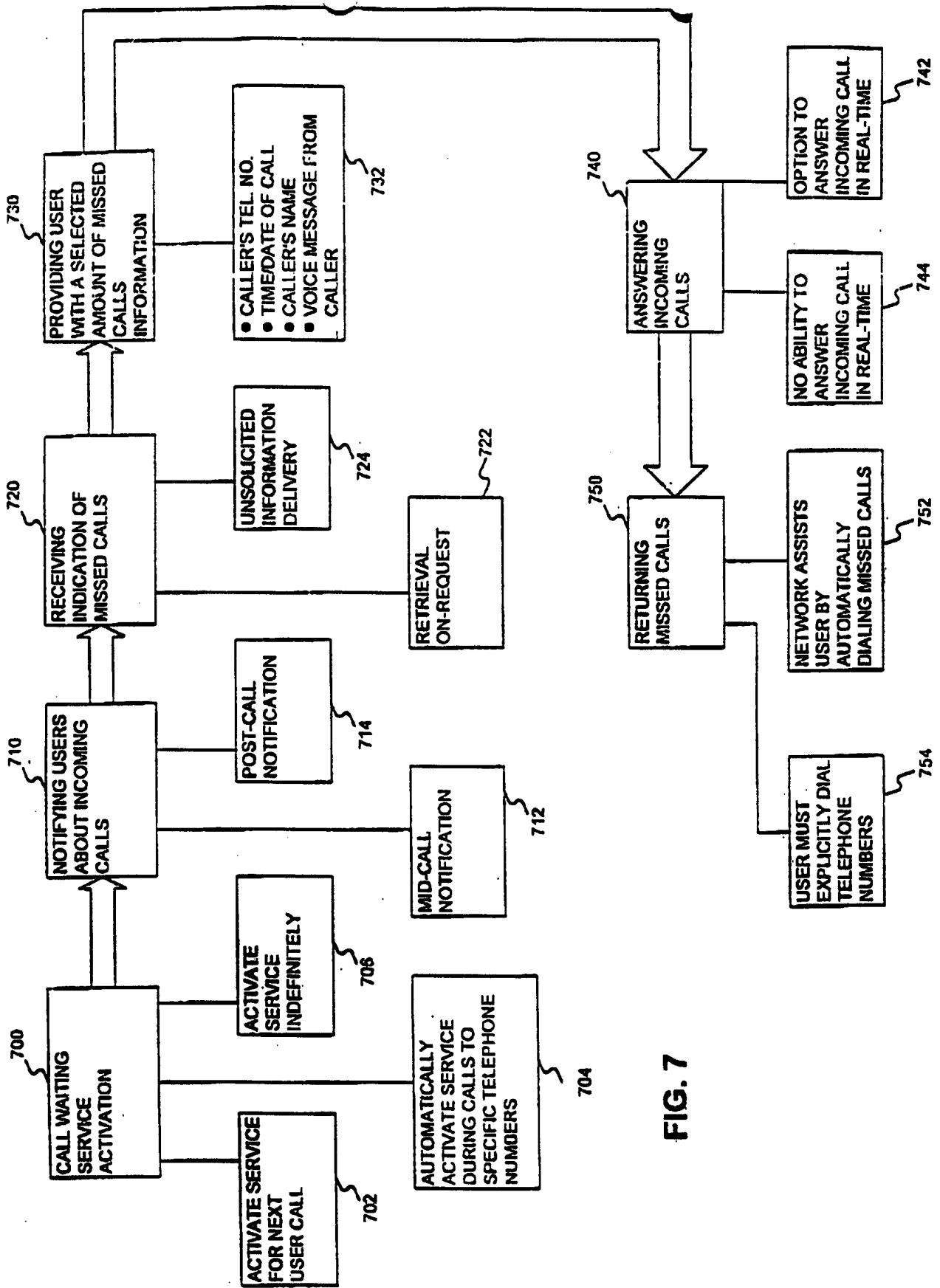

FIG. 7

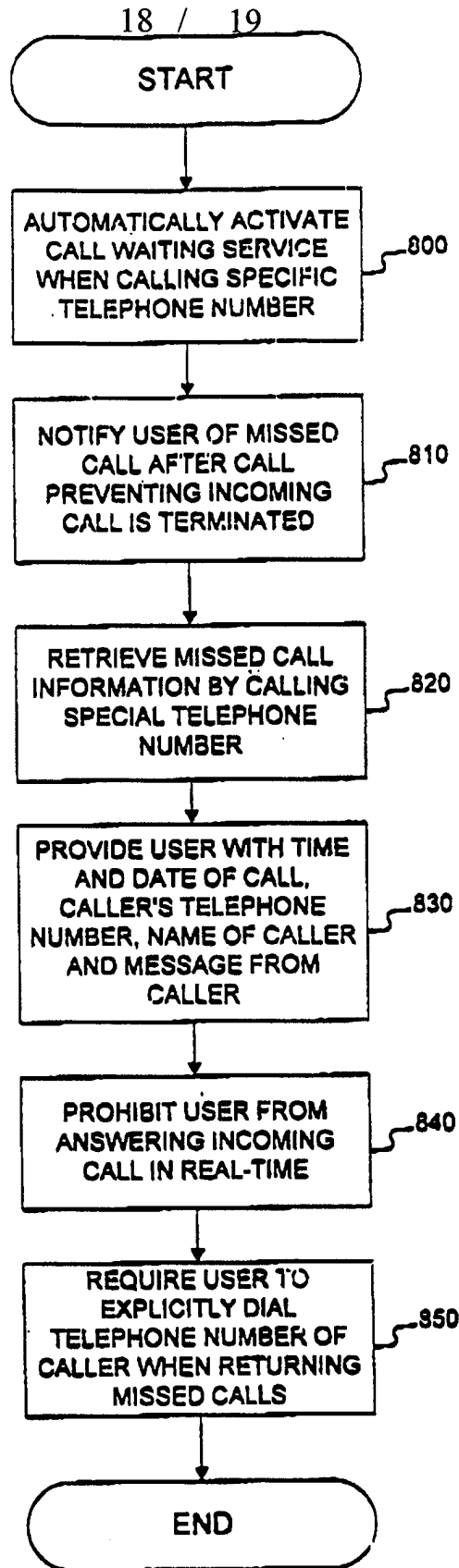

FIG. 8

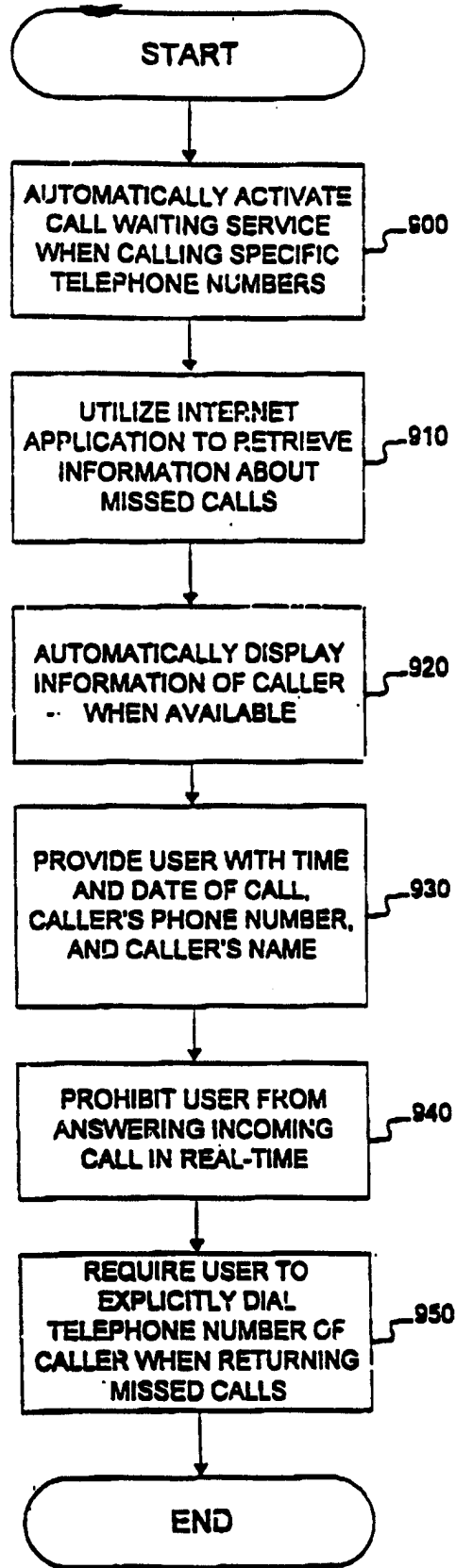

FIG. 9

**INTERNATIONAL SEARCH REPORT**

International application No.  
PCT/US98/10451

**A. CLASSIFICATION OF SUBJECT MATTER**  
 IPC(6) :H04L 12/28, 12/56; H04M 3/42  
 US CL :370/352, 379/215  
 According to International Patent Classification (IPC) or to both national classification and IPC

**B. FIELDS SEARCHED**  
 Minimum documentation searched (classification system followed by classification symbols)  
 U.S. : Please See Extra Sheet.

Documentation searched other than minimum documentation to the extent that such documents are included in the fields searched

Electronic data base consulted during the international search (name of data base and, where practicable, search terms used)  
 APS (PSTN, internet, call waiting, ISP, call attempts, computer)

**C. DOCUMENTS CONSIDERED TO BE RELEVANT**

Category*	Citation of document, with indication, where appropriate, of the relevant passages	Relevant to claim No.
Y, P	US 5,712,907 A (WEGNER et al) 27 January 1998, col. 7, line 24 to col. 8, line 11.	1-18
Y, P	US 5,751,706 A (LAND et al) 12 May 1998, col. 5, line 30 to col. 6, line 61.	1-18
Y	YANG, C. INETPhone: Telephone Services and Servers on Internet, RFC 1789, April 1995, pgs. 1-6.	1-18
A	US 4,771,725 A (BARAN et al) 13 September 1988.	1-18
A, P	US 5,724,412 A (SRINIVASAN) 03 March 1998.	1-18
A	US 5,095,480 A (FENNER) 10 March 1992.	1-18

Further documents are listed in the continuation of Box C.  See patent family annex.

* Special categories of cited documents:	"T" later document published after the international filing date or priority date and not in conflict with the application but cited to understand the principle or theory underlying the invention
"A" document defining the general state of the art which is not considered to be of particular relevance	"X" document of particular relevance; the claimed invention cannot be considered novel or cannot be considered to involve an inventive step when the document is taken alone
"E" earlier document published on or after the international filing date	"Y" document of particular relevance; the claimed invention cannot be considered to involve an inventive step when the document is combined with one or more other such documents, such combination being obvious to a person skilled in the art
"L" document which may throw doubts on priority claim(s) or which is cited to establish the publication date of another citation or other special reason (as specified)	"&" document member of the same patent family
"O" document referring to an oral disclosure, use, exhibition or other means	
"P" document published prior to the international filing date but later than the priority date claimed	

Date of the actual completion of the international search 14 AUGUST 1998	Date of mailing of the international search report <b>08 OCT 1998</b>
---	--

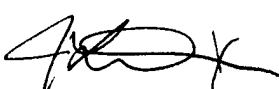
Name and mailing address of the ISA/US Commissioner of Patents and Trademarks Box PCT Washington, D.C. 20231 Facsimile No. (703) 305-3230	Authorized officer <b>JASON CHAN</b>  Telephone No. (703) 305-3900
---	---

INTERNATIONAL SEARCH REPORT

International application No.  
PCT/US98/10451

C (Continuation). DOCUMENTS CONSIDERED TO BE RELEVANT

Category*	Citation of document, with indication, where appropriate, of the relevant passages	Relevant to claim No.
A, E	US 5,790,548 A (SISTANIZADEH et al) 04 August 1998.	1-18

**INTERNATIONAL SEARCH REPORT**

International application No.  
PCT/US98/10451

**B. FIELDS SEARCHED**

Minimum documentation searched

Classification System: U.S.

370/352, 353, 354, 355, 356, 383, 389, 390, 392, 401, 408, 410; 379/89, 90.01, 93.01, 93.07, 923.08, 93.14, 93.29, 100.11, 100.13, 114, 208, 210, 211, 212, 215