



US00D757244S

(12) **United States Design Patent**  
**Sung**

(10) **Patent No.:** **US D757,244 S**

(45) **Date of Patent:** **\*\* May 24, 2016**

(54) **SENSOR FOR RESPIRATOR MASK**

(71) Applicant: **SLS MEDICAL TECHNOLOGY CORP. LTD.**, Taichung (TW)

(72) Inventor: **Ching-Lung Sung**, Taichung (TW)

(73) Assignee: **SLS MEDICAL TECHNOLOGY CORP. LTD.**, Taichung (TW)

(\*\*) Term: **14 Years**

(21) Appl. No.: **29/518,820**

(22) Filed: **Feb. 27, 2015**

(51) **LOC (10) Cl.** ..... **29-02**

(52) **U.S. Cl.**  
USPC ..... **D24/110**

(58) **Field of Classification Search**  
USPC ..... D24/107, 110-110.6, 127, 129, 164;  
D8/307, 308, 322, 338  
CPC ..... A62B 18/00; A62B 18/02; A62B 18/025;  
A62B 23/025; A62B 23/02; A62B 7/10;  
A62B 19/00; A62B 23/00; A61M 16/0622;  
A61M 16/06; A61M 16/0616; A61M 16/0003;  
A61M 2230/40; A61M 2230/50; A61M  
16/0051; A61M 16/161; A61B 5/0878;  
A61B 5/0816; A61B 5/087; A61B 5/08;  
A61B 5/082; A61B 5/113  
See application file for complete search history.

(56) **References Cited**

**U.S. PATENT DOCUMENTS**

5,063,938	A *	11/1991	Beck	.....	A61B 5/0816
					128/200.26
D329,189	S *	9/1992	Beck	.....	D8/322
D520,855	S *	5/2006	Osiecki	.....	D8/308
D601,401	S *	10/2009	Neidich	.....	D8/307
D704,027	S *	5/2014	Trunek	.....	D8/308
9,080,347	B2 *	7/2015	Le	.....	E05B 1/003

9,144,654	B2 *	9/2015	Kwok	.....	A61F 5/56
2002/0026937	A1 *	3/2002	Mault	.....	A61B 5/0002
					128/200.24
2002/0139368	A1 *	10/2002	Bachinski	.....	A61M 16/06
					128/204.23
2002/0162556	A1 *	11/2002	Smith	.....	A61B 5/087
					128/207.12
2004/0163648	A1 *	8/2004	Burton	.....	A61B 5/04085
					128/204.21
2005/0268916	A1 *	12/2005	Mumford	.....	A61M 16/06
					128/207.13
2014/0005497	A1 *	1/2014	Larsen	.....	A61B 5/6803
					600/301

\* cited by examiner

*Primary Examiner* — Barbara Fox

*Assistant Examiner* — Lilyana Bekic

(74) *Attorney, Agent, or Firm* — Muncy, Geissler, Olds & Lowe, P.C.

(57) **CLAIM**

The ornamental design for a sensor for respirator mask, as shown and described.

**DESCRIPTION**

FIG. 1 is a perspective view of a sensor for respirator mask showing the present design;  
FIG. 2 is a front view of the present design;  
FIG. 3 is a rear view of the present design;  
FIG. 4 is a left side view of the present design;  
FIG. 5 is a right side view of the present design;  
FIG. 6 is a top view of the present design;  
FIG. 7 is a bottom view of the present design; and,  
FIG. 8 is a left side view thereof, shown in an environment of use.

The broken line showing of the respirator mask in FIG. 8 illustrates environment and forms no part of the claimed design. All other broken lines illustrate portions of the sensor for respirator mask that form no part of the claimed design.

**1 Claim, 6 Drawing Sheets**

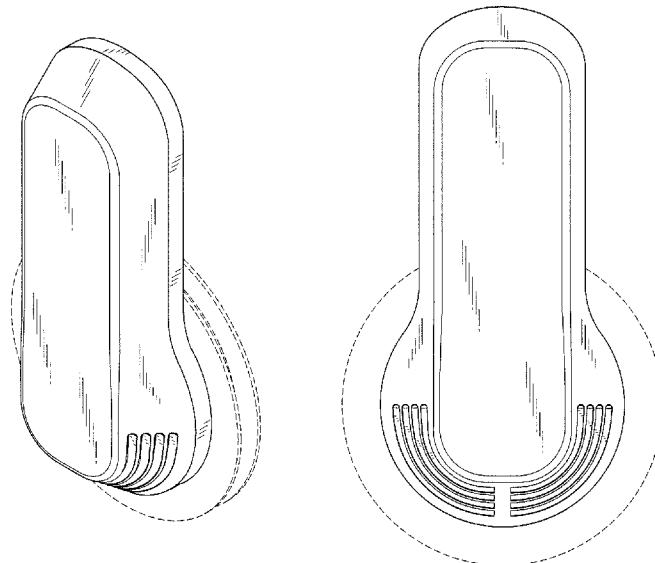

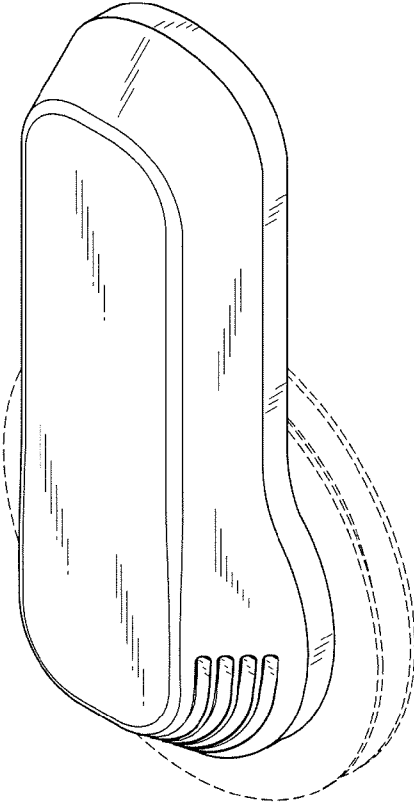

FIG. 1

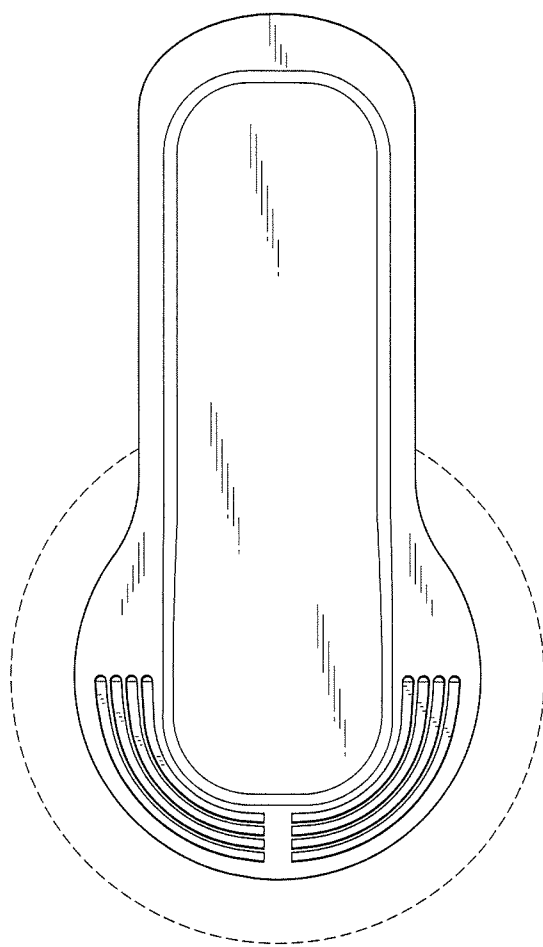

FIG. 2

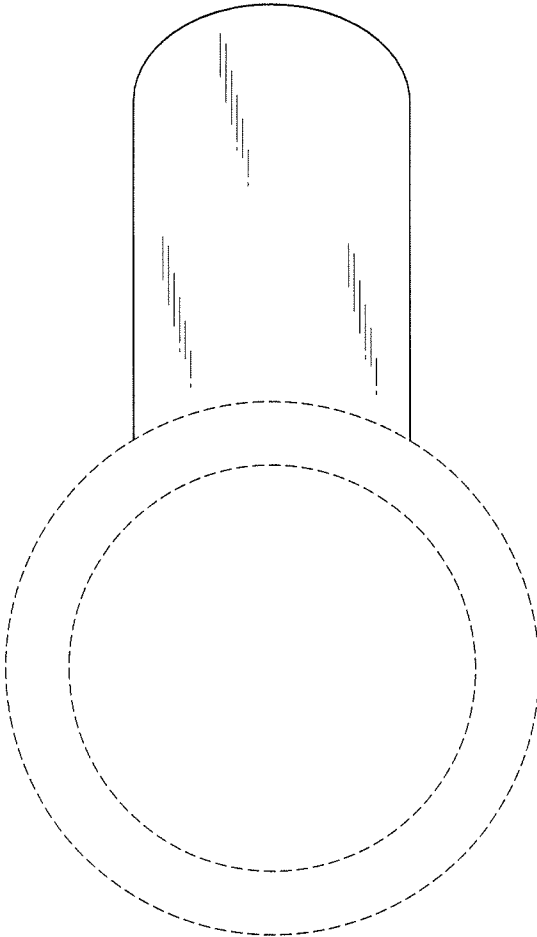

FIG. 3

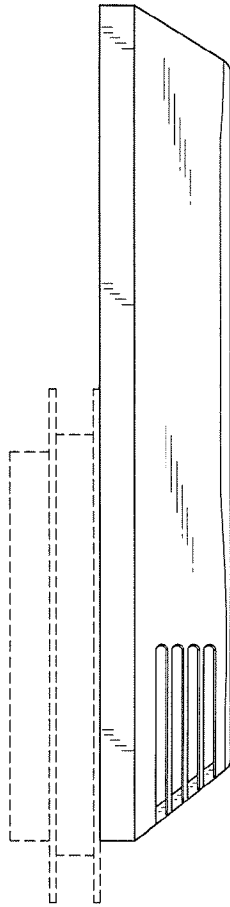

FIG. 4

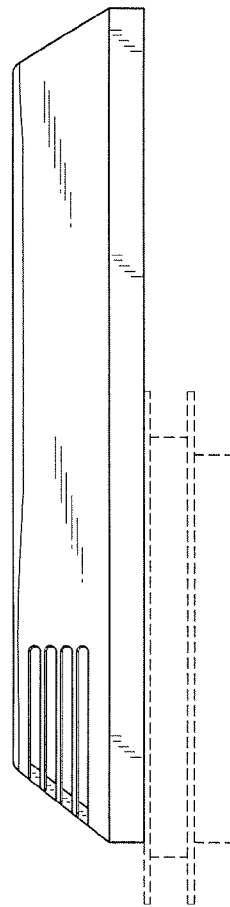

FIG. 5

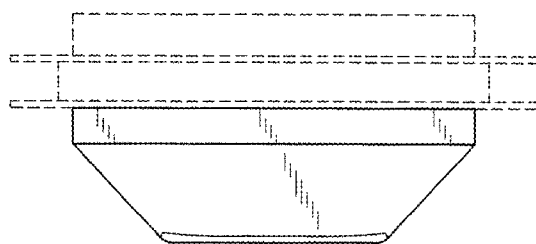

FIG. 6

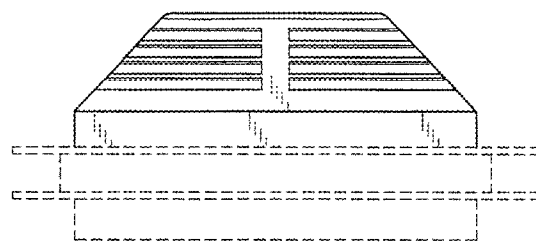

FIG. 7

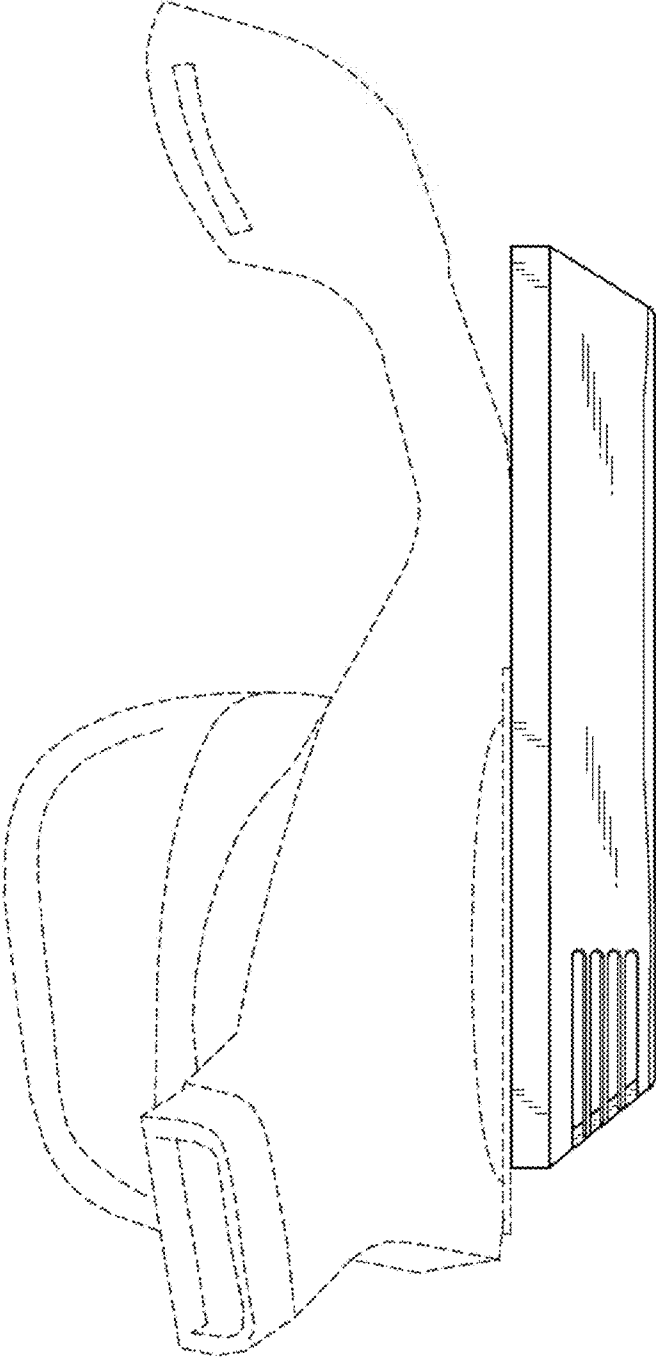

FIG. 8