



US00D700806S

(12) **United States Design Patent**
Joy

(10) **Patent No.:** **US D700,806 S**

(45) **Date of Patent:** **** Mar. 11, 2014**

- (54) **BEVERAGE GLASS**
- (71) Applicant: **LifeFactory, Inc.**, Sausalito, CA (US)
- (72) Inventor: **Daren Joy**, Sausalito, CA (US)
- (73) Assignee: **Lifefactory, Inc.**, Sausalito, CA (US)
- (**) Term: **14 Years**
- (21) Appl. No.: **29/454,467**
- (22) Filed: **May 10, 2013**
- (51) **LOC (10) Cl.** **07-01**
- (52) **U.S. Cl.**
USPC **D7/507; D7/523; D7/509; D7/624.2**
- (58) **Field of Classification Search**
CPC **A47G 19/22; A47G 19/23; A45F 3/16**
USPC **D7/523, 507, 514, 624.2, 607, 608;**
215/11.1, 11.6; 206/459.5; 220/739
See application file for complete search history.

D621,259 S *	8/2010	Joy et al.	D9/444
D623,899 S *	9/2010	Baratte	D7/531
D629,259 S *	12/2010	Joy et al.	D7/624.2
D634,159 S *	3/2011	Bodum	D7/509
D644,072 S *	8/2011	McDonald et al.	D7/667
8,579,133 B2 *	11/2013	Marcus et al.	215/11.6
D696,080 S *	12/2013	Joy	D7/629
8,608,018 B2 *	12/2013	Babinsky et al.	220/739
2009/0057257 A1 *	3/2009	Marcus et al.	215/11.6

* cited by examiner

Primary Examiner — Marianne Pandozzi
(74) *Attorney, Agent, or Firm* — The Mueller Law Office, P.C.

(57) **CLAIM**
The ornamental design for a beverage glass, as shown and described.

DESCRIPTION

FIG. 1 shows a perspective view of a design for a beverage glass.
 FIG. 2 shows a front view of the design.
 FIG. 3 shows a back view of the design.
 FIG. 4 shows a left side view of the design.
 FIG. 5 shows a right side view of the design.
 FIG. 6 shows a top view of the design.
 FIG. 7 shows a bottom view of the design.
 FIG. 8 shows an oblique perspective view of the design; and,
 FIG. 9 shows another oblique perspective of the design.

1 Claim, 9 Drawing Sheets

- (56) **References Cited**
U.S. PATENT DOCUMENTS
- | | | | | |
|--------------|---------|-----------------|-------|--------|
| D78,014 S * | 3/1929 | Dunbar | | D7/523 |
| D206,889 S * | 2/1967 | Benes | | D7/523 |
| D216,096 S * | 11/1969 | Lawton | | D9/501 |
| D267,332 S * | 12/1982 | Pirovano et al. | | D19/85 |
| D492,547 S * | 7/2004 | Hsu | | D7/523 |
| D567,094 S * | 4/2008 | Bickert | | D9/529 |
| D612,687 S * | 3/2010 | Gilbert et al. | | D7/509 |
| D615,816 S * | 5/2010 | Joy et al. | | D7/507 |

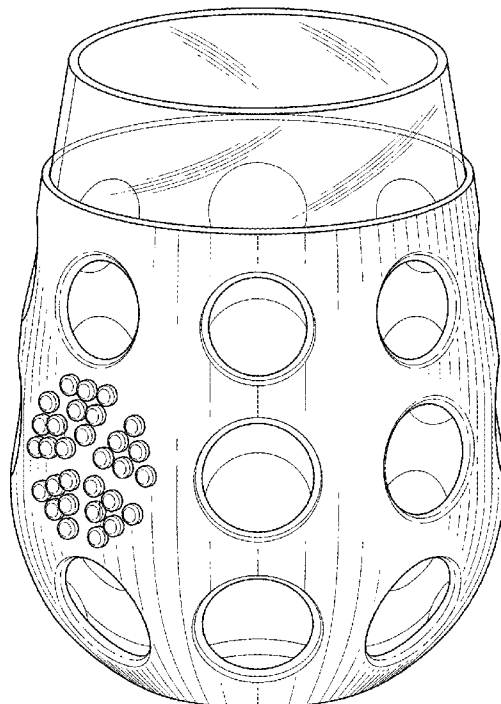

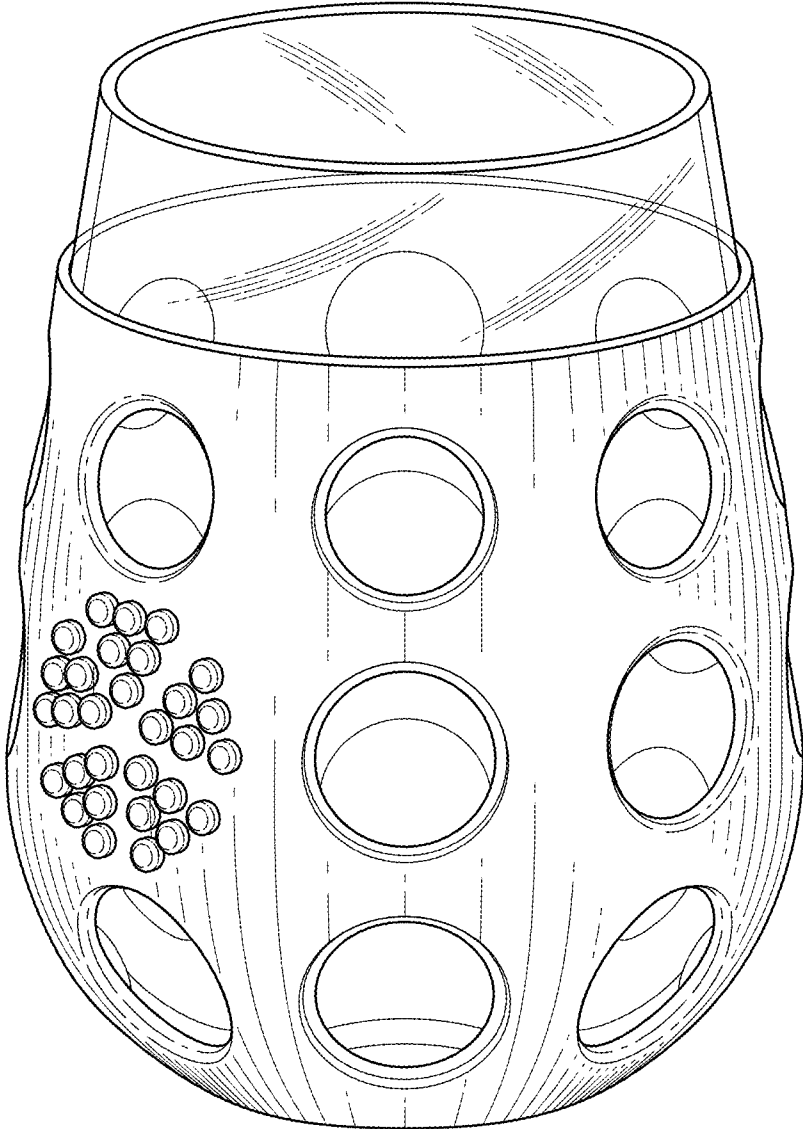

FIG. 1

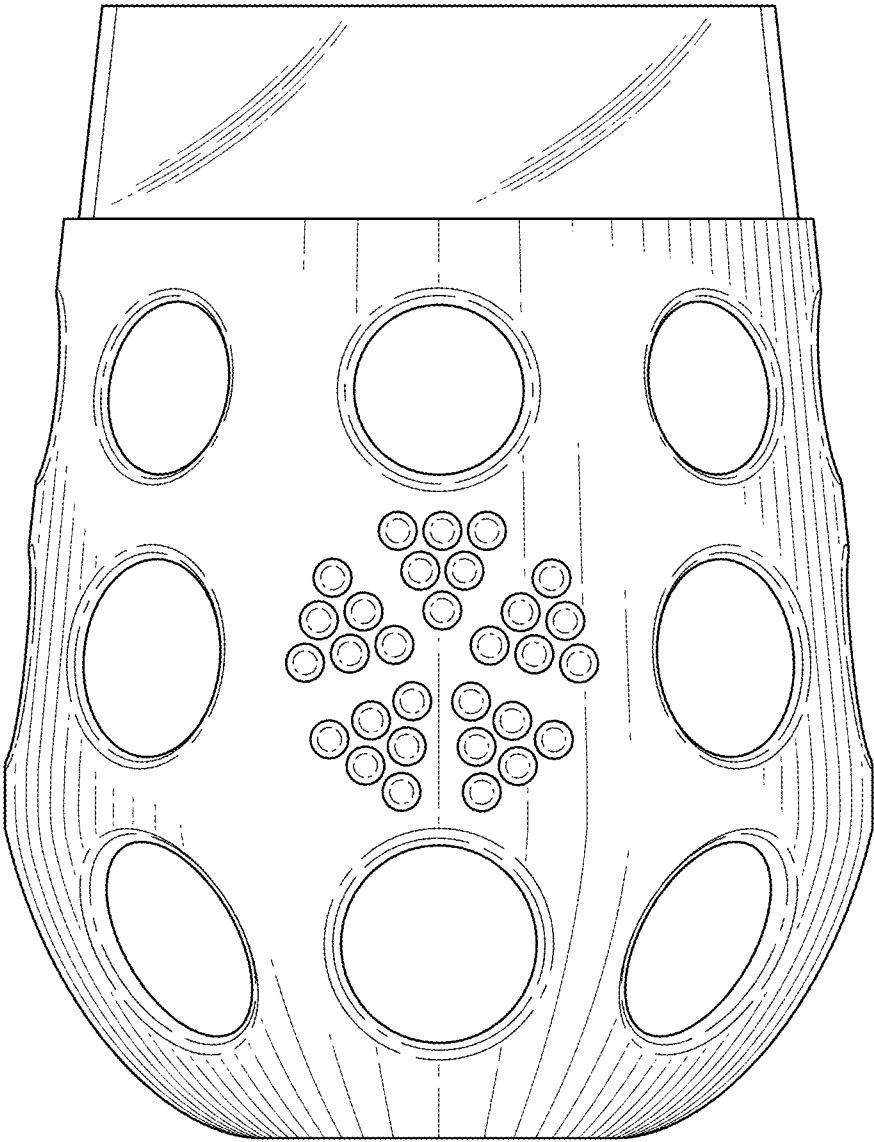

FIG. 2

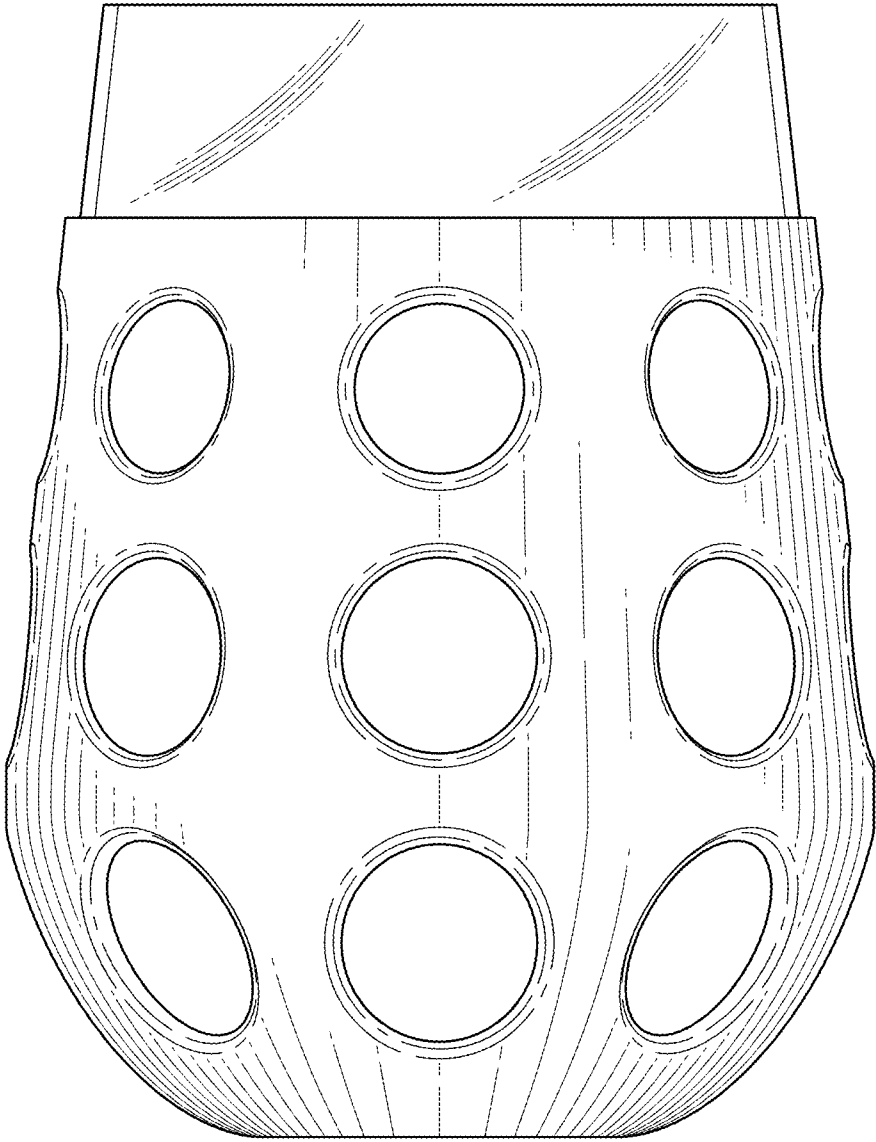

FIG. 3

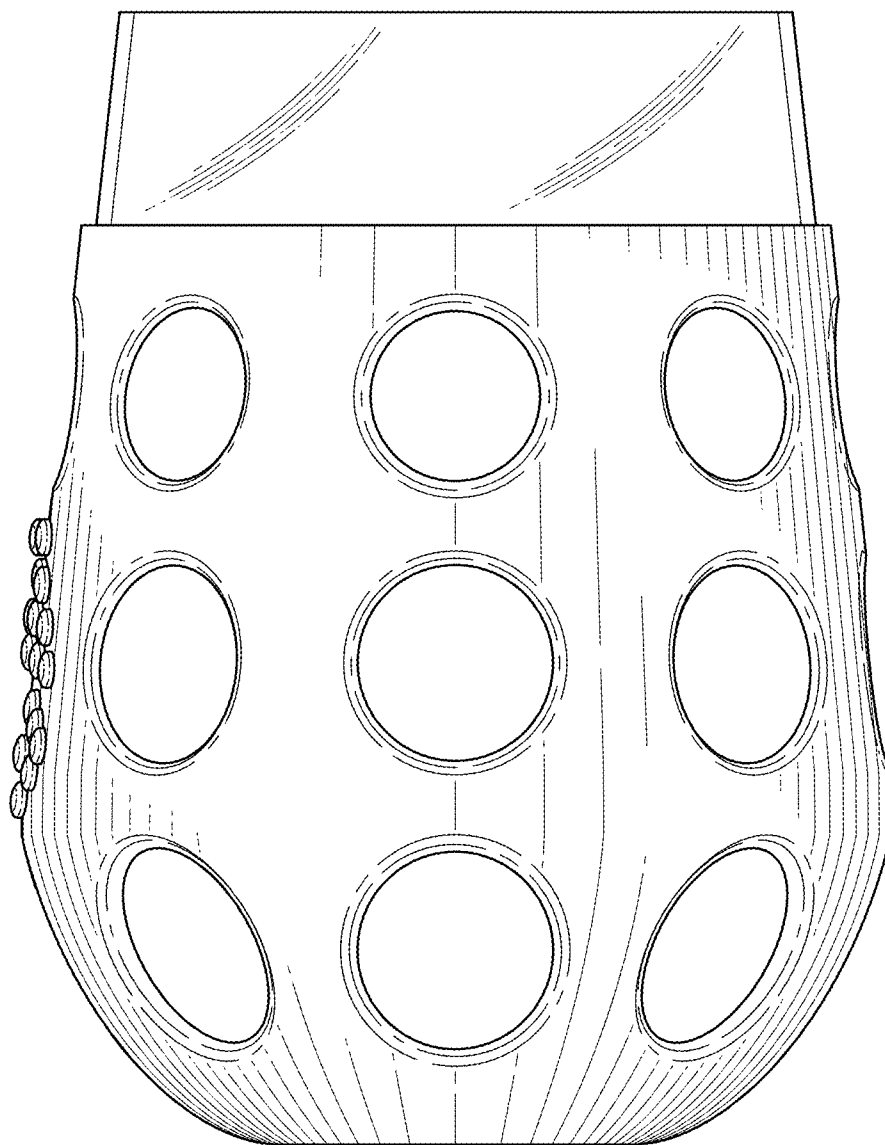

FIG. 4

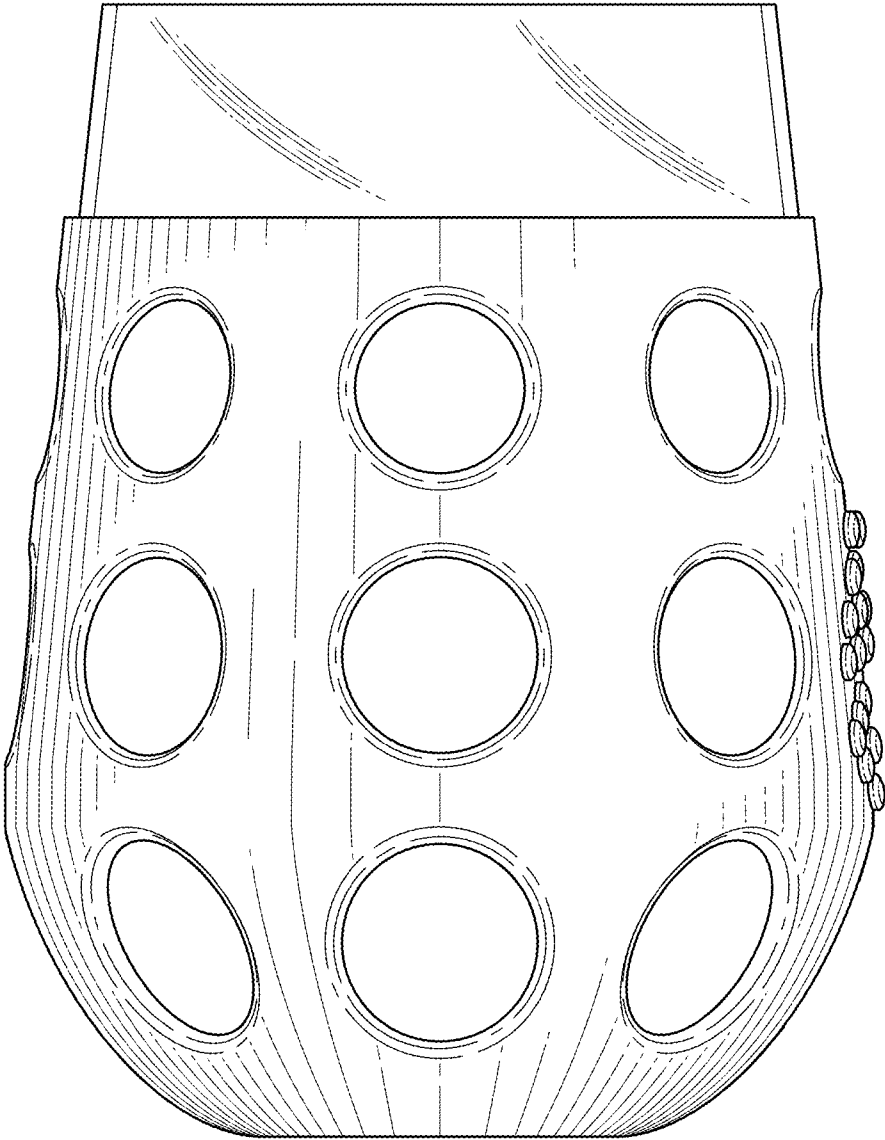

FIG. 5

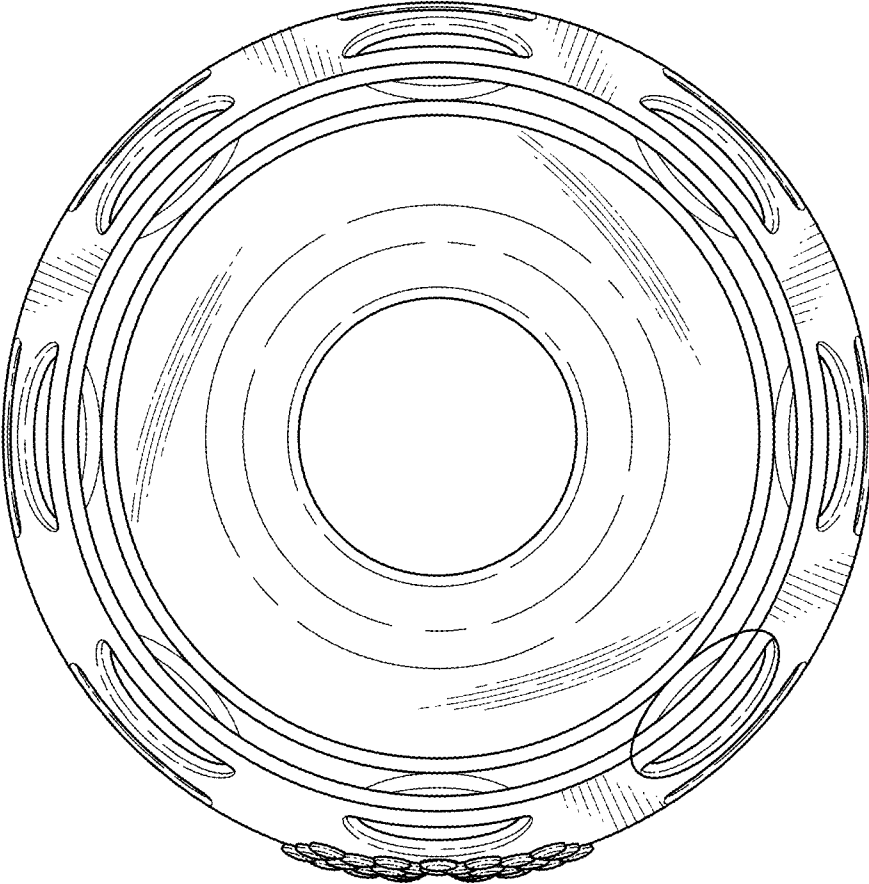

FIG. 6

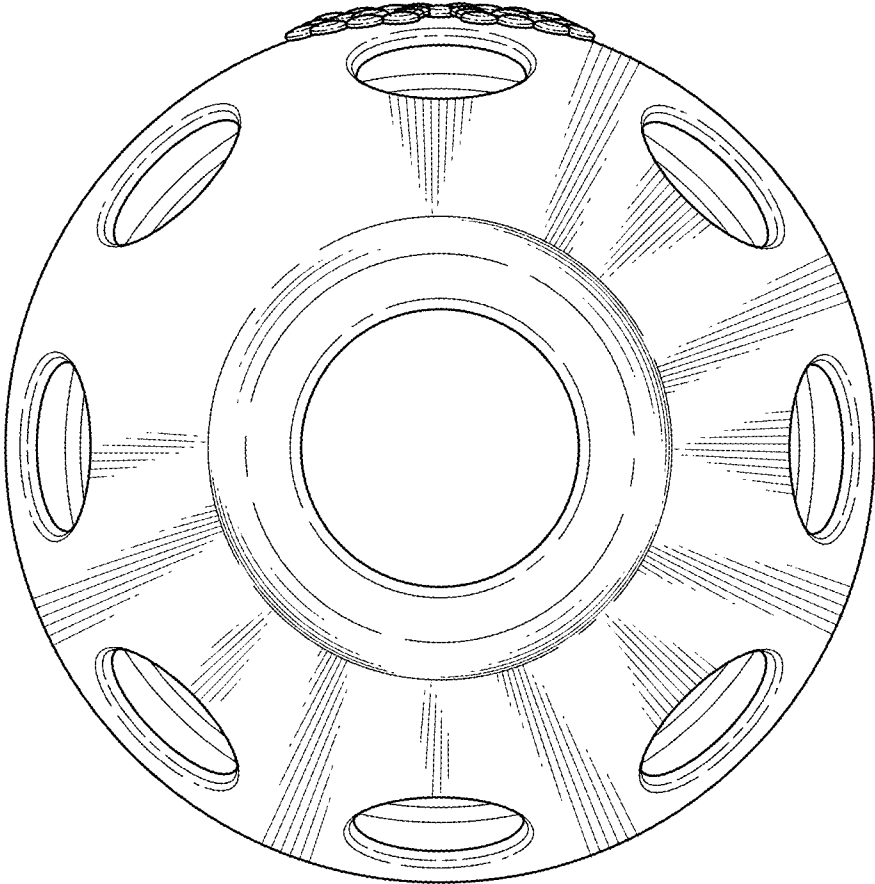

FIG. 7

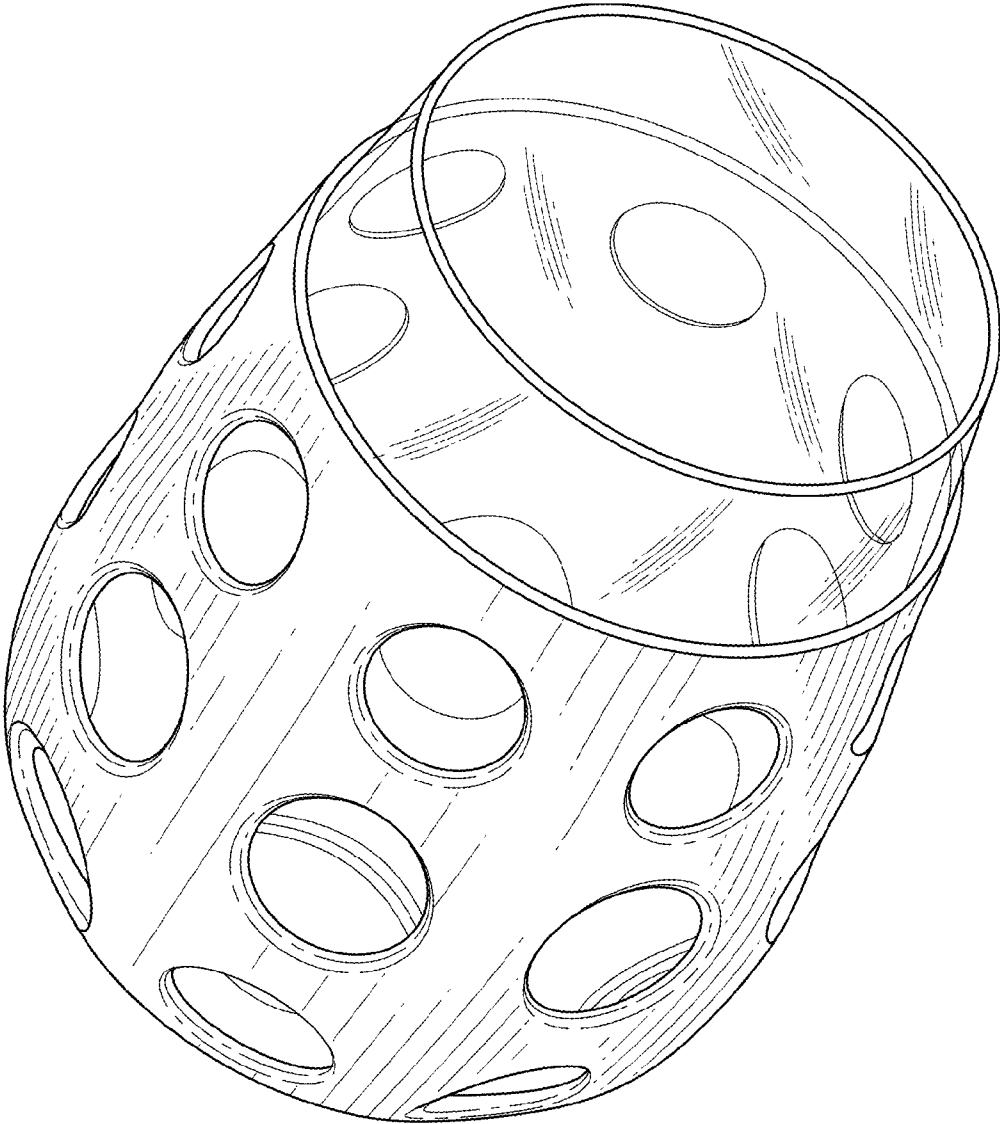

FIG. 8

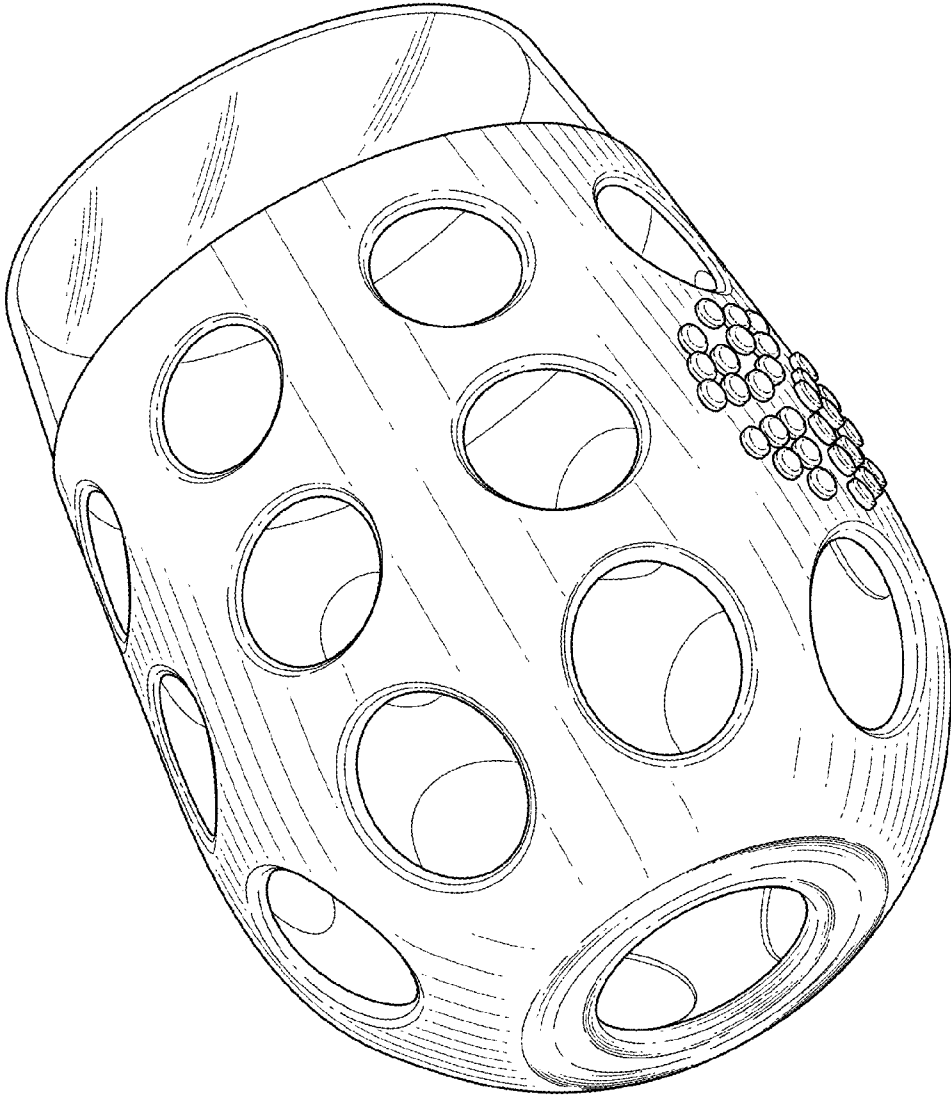

FIG. 9