

(19) World Intellectual Property Organization
International Bureau



(43) International Publication Date
28 December 2000 (28.12.2000)

PCT

(10) International Publication Number
WO 00/78391 A1

(51) International Patent Classification⁷: **A61N 1/365**,
A61B 5/05

7177 Gray Heron Drive, Lino Lakes, MN 55015 (US). **NU-
GENT, Kevin, G.**; 3340 Irving Avenue South, Minneapo-
lis, MN 55408 (US).

(21) International Application Number: PCT/US00/12403

(74) Agent: **NIKOLAI, Thomas, J.**; Nikolai, Mersereau & Di-
etz, P.A., Suite 820, 900 Second Avenue South, Minneapo-
lis, MN 55402-3325 (US).

(22) International Filing Date: 5 May 2000 (05.05.2000)

(25) Filing Language: English

(81) Designated States (*national*): AU, CA, JP.

(26) Publication Language: English

(84) Designated States (*regional*): European patent (AT, BE,
CH, CY, DE, DK, ES, FI, FR, GB, GR, IE, IT, LU, MC,
NL, PT, SE).

(30) Priority Data:
09/336,449 21 June 1999 (21.06.1999) US

Published:

- With international search report.
- With amended claims and statement.

(71) Applicant: **CARDIAC PACEMAKERS, INC.** [US/US];
4100 N. Hamline Avenue, St. Paul, MN 55112-5798 (US).

*For two-letter codes and other abbreviations, refer to the "Guid-
ance Notes on Codes and Abbreviations" appearing at the begin-
ning of each regular issue of the PCT Gazette.*

(72) Inventors: **SALO, Rodney, W.**; 135-71st Way N.E., Fri-
dley, MN 55112 (US). **KADHIRESAN, Veerichetty, A.**;

(54) Title: MULTI-SITE IMPEDANCE SENSOR USING CORONARY SINUS/VEIN ELECTRODES

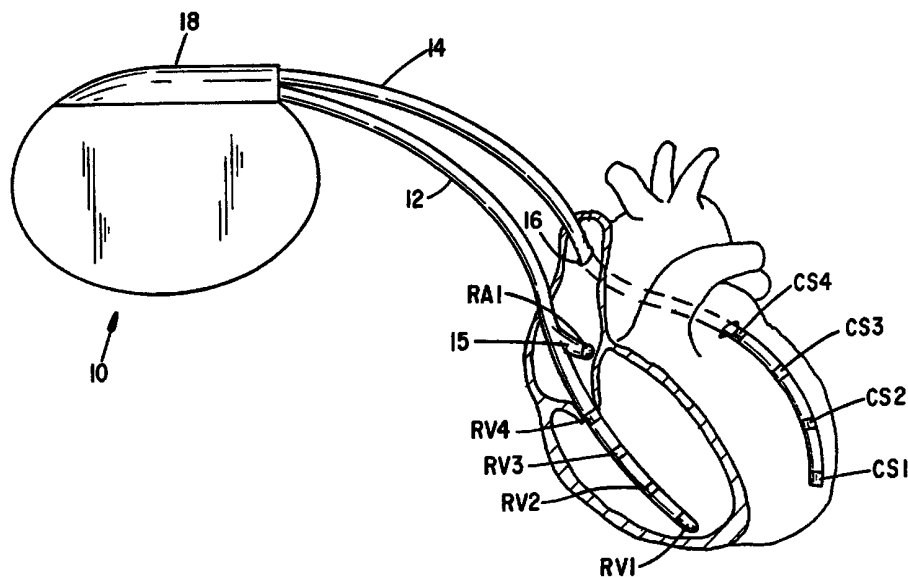

(57) Abstract: A method and apparatus for performing impedance plethysmography on a living heart for diagnostic and therapy purposes involves placement of plural leads where at least one is disposed within a coronary vein traversing the myocardium on the left side of the heart with another lead having plural electrodes thereon disposed in the right ventricle. By appropriate selection of electrodes on the first and second leads for driving with an AC carrier signal and other such electrodes coupled to a sensing amplifier, an impedance vs. time signal can be derived that when signal processed provides useful information concerning cardiac performance. The multi-site impedance sensing has been found to yield more robust data especially in patients having CHF.

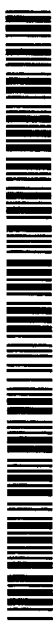

WO 00/78391 A1

**MULTI-SITE IMPEDANCE SENSOR USING
CORONARY SINUS/VEIN ELECTRODES**

BACKGROUND OF THE INVENTION

I. Field of the Invention: This invention relates
5 generally to cardiac rhythm management apparatus
incorporating impedance sensing capability, and more
particularly to a multi-site impedance sensing system
having one or more leads arranged to localize sensing of
impedances in the left ventricular chamber.

10 **II. Discussion of the Prior Art:** The first use of
electrical impedance to attempt to measure the chamber
volume of the heart reported by Geddes, et al. in a paper
entitled "Continuous Measurement of Ventricular Stroke
Volume by Electrical Impedance", Cardiovascular Research
15 Center Bulletin, Vol. 4, pp. 118-131, ©1966, involved the
use of a pair of epicardial electrodes which were sewn to
the surface of the left ventricle spanning its volume. A
constant AC current was injected between these electrodes
and the potential difference generated was used as a
20 measure of the left ventricular volume. Converting the
potential difference into electrical resistance, the group
obtained calibration constants for this technique of 4.2-
10.0 ml./ohm and found the calibration to be highly
dependent on the individual. Because the electrodes were
25 sutured into position, the separation was highly stable and
there was very little signal artifact due to motion of the
electrodes.

In 1970, in an effort to reduce the invasiveness of
the technique, the same research group made similar
30 measurements using a single multi-electrode catheter
positioned in the left ventricle. They obtained similar
results to the initial studies but the technique was only
useful acutely due to the possibility of thrombus formation
in the left heart and its attendant dangers. Subsequent
35 research concentrated on acute catheter-based measurements
in the left heart primarily because knowledge of the
function of the left ventricle was considered to be more

-2-

critical than the right ventricle for most patient conditions.

The first application of impedance plethysmography to an implantable device is described in Salo, et al. Patent 5,190,035 which uses electrical impedance from a single multi-electrode lead positioned in the right ventricle to measure stroke volume. In its simplest implementation, this approach required a three-electrode lead. The current source was connected between the distal tip electrode and the pacemaker case and the measurement of impedance was made between the two remaining ring electrodes, which were positioned within the right ventricle. This arrangement was satisfactory for the measurement of stroke volume, since right and left ventricular stroke volumes must remain, on the average, equal. The system was relatively unpopular due to its requirement for a non-standard tri-polar lead and was also unable to measure left ventricular parameters in situations (such as left bundle branch block, etc.) where the left ventricular performance can diverge from that of the right ventricle.

The requirement for a three electrode lead was addressed by the Hauck, et al. Patent No. 5,036,894 which teaches the utilization of the pacemaker metal can and an additional electrode disposed on the device's insulating lead connector block as the two proximal electrodes. Thus, it was possible to make tetra polar impedance measurements using a standard bipolar pacing lead in the right ventricle. Obviously, this configuration did not address the measurement of left ventricular parameters and was also sensitive to global impedance changes within the torso (such as respiration) due to the wide separation of sensing electrodes.

A further area of concern is the sensitivity of the lead system to motion. The heart is constantly in violent motion. During each cardiac cycle, there is inward and outward movement of septal and lateral walls, upward motion of the apex and spiral movement of the entire chamber

wringing the blood out of the ventricles. In addition, the whole heart swings from the great vessels. These cardiac motions promote lead motions which result in impedance changes which are misinterpreted as changes in volume.

5 Separating current sources and measuring electrodes can diminish the impact of this motion, by placing the measuring electrodes in regions of more uniform current density. The situation can also be improved by fixing the electrodes in position so that they cannot move relative to

10 the heart. pacing leads have been found to become fixed in position by fibrotic encapsulation in the first two weeks and measurements made before this process is completed are suspect. In fact, we have noted that about half the amplitude of impedance signals acquired immediately after

15 implant is a result of lead motion and unrelated to ventricular volume.

The application of impedance plethysmography is additionally difficult when the goal is to make measurements in dilated hearts. Because of the large

20 volume of these hearts (up to five or even ten times that of a normal heart) the average measured impedance is very low. In addition, the ejection fraction of these hearts may be as low as five percent resulting in a very small absolute change in impedance during the cardiac cycle.

25 Thus, the signal/noise in these patients is much worse than for patients with normal hearts. The baseline impedance, which follows the equation: $Z = \rho \cdot L^2 / V$ (where ρ is the resistivity of the blood, L is the distance between sensing electrodes and V is the chamber volume) can be increased by

30 increasing the inter-electrode distance, L with significant improvement in signal/noise.

The subject of this application is an impedance plethysmography system to meet the multiple requirements of an implantable system. These requirements are that it 1)

35 utilize simple and, if possible, standard leads and not require leads in addition to those necessary for therapy application, 2) measure left ventricular cardiac function,

3) be relatively immune to motion of the heart permitting accurate measurement from the time of system implant and be usable in dilated chambers, such as those in patients with moderate to severe heart failure, with inherently poor signal/noise ratio.

SUMMARY OF THE INVENTION

The invention is based on the utilization of at least one electrode on a coronary sinus/vein lead positioned in an anterior or posterior vein of the left ventricle and electrodes on pacing or defibrillation leads position in the right ventricle and/or right atrium. The coronary vein lead may be positioned for pacing in a distal portion of a coronary vein and may be combined with a right ventricular or right atrial lead to span the left ventricular blood volume. A high frequency current source and sensing amplifier may be connected to electrodes available on these leads in a number of ways to measure electrical impedance. In each of these configurations, the sensing electrodes span some region of the left ventricle and would, therefore, be sensitive to left ventricular volume and wall motion.

This arrangement meets all the requirements outlined previously. It does not require leads or electrodes in addition to those necessary for pacing or defibrillation therapy. It is primarily sensitive to left ventricular function and because the coronary vein electrode has very limited motion (being confined to the inner diameter of the distal portion of a coronary vein), is relatively free of lead motion artifact. Finally, the ability to increase the distance between sensing electrodes by choosing distant combinations of electrodes improves the signal-to-noise ratio in dilated hearts.

DESCRIPTION OF THE DRAWINGS

The foregoing features, objects and advantages will become apparent to those skilled in the art from the following detailed description of a preferred embodiment

especially when considered in conjunction with the accompanying drawings in which:

Figure 1 diagrammatically depicts a heart having multiple-electrode right ventricular and coronary sinus leads coupled to a cardiac rhythm management device;

Figures 2A, 2B, 2C, 2D and 2E schematically display drive and sense electrode combinations for measuring electrical impedance utilizing coronary vein, right ventricular and right atrial electrodes, each combination showing differing sensitivities to desired cardiac parameters, such as left ventricular volume and timing of ejection and filling; and

Figure 3 is a schematic block diagram of the cardiac rhythm management device shown in Figure 1.

DESCRIPTION OF THE PREFERRED EMBODIMENT

Referring first to Figure 1, there is indicated generally by numeral 10 a cardiac rhythm management device which may, typically, comprise a cardiac pacemaker, and/or a defibrillator that would be implantable within a patient. Alternatively, the device 10 may be an external unit for use in acute studies for diagnostic purposes. In this specification, the device 10 will be considered to be designed to apply electrical stimulation therapy for congestive heart failure and to monitor the cardiac output to permit optimization of the pacing site or the relative timing (AV delay) between the sensing of an atrial depolarization signal and electrical stimulation of the left (and possibly right) ventricle. This is done by periodically changing the pacing site, e.g., by pacing at a different coronary vein electrode, or by changing the AV delay and monitoring the evoked change in cardiac output to determine whether it increases or decreases. This procedure can be continued until the cardiac output is maximized.

The device 10 is shown as being connected to a right ventricular lead 12 having two electrodes labeled RV1 and RV2. While two electrodes are illustrated, it should be

understood that a greater or fewer number may be employed on the lead 12. A coronary sinus lead 14 is shown as entering the coronary sinus 16 in the right atrium and extending therethrough and into a vein traversing the myocardium on the left side of the heart. The coronary
5 sinus lead 14 is illustrated as having a plurality of electrodes CS1 through CS4 on a surface thereof and connected by individual conductors within the lead 14 to circuitry within the device 10. Again, while four such
10 electrodes are shown, it is only for the purpose of illustration and, typically, a fewer number of electrodes would be placed on the CS lead 14 because of size constraints of the lumen in which the lead is to be placed. It is further contemplated that an additional lead 15 with
15 an electrode RA1 may be positioned at a location abutting the right atrial wall of the heart. The atrial lead 15 may be a branch off the right atrial lead 12 and will include a conductor connecting RA1 to contacts within the connector 18 of the pacemaker device 10.

20 Referring next to Figure 3, the internal circuitry of the device 10 is shown as being enclosed in the dashed line box 20. It includes a microprocessor based controller 22. Connected to the microprocessor 22 is an address bus 24, a data bus 26 and a control bus 28. Connected to each of
25 these buses is a ROM memory 30 storing a program of instructions executable by the microprocessor 22 for carrying out the control functions yet to be described. Also connected to the buses 24, 26 and 28 is a RAM memory 32 which may store various control parameters called upon
30 by the microprocessor 22 during execution of its program. The RAM 32 may also store data resulting from computations for later read-out to an external monitor 34, via I/O circuit 36 and a telemetry link 38. Of course, data and programmable parameters may also be entered into the
35 implanted unit, via the external monitor, the telemetry link and the I/O module 36.

The microprocessor-based controller 22 is connected by a control line 40 to a "select" input of a switching matrix 42 whereby selected ones of the several electrodes RV1, RV2, CS1-CS4 and RA1 may be selected to function either as a drive electrode or a sense electrode. A hard-wired connection may also be used.

In implementing impedance plethysmography, an oscillator circuit 44 is provided. It, too, is controlled by a microprocessor 22 to produce an AC carrier signal on lines 46 whose amplitude is below that which is required to evoke capture (depolarization) of the heart and whose frequency may be typically 5-10 KHz. The switch matrix 42 permits the carrier signal to be applied across a selected pair of electrodes on the leads 12, 14 and 15. Likewise, a selected pair of these electrodes, preferably not used for applying the carrier signal, may be selected to function as sensing electrodes and they are connected, via the switch matrix 42, to a sense amplifier 48.

As those skilled in the art appreciate, the application of the AC carrier signal across a pair of electrodes creates an electric field and since blood is a fairly good conductor, the inflow and outflow of blood from the heart results in a change in impedance and, therefore, the voltage being picked up by the selected pair of sensing electrodes. The output from the sense amplifier 48 may be suitably filtered, as at 50, to remove the high frequency carrier component of the composite signal picked up by the sense amplifier, thereby leaving the ECG waveform. This waveform may be digitized by an analog-to-digital converter 52 and applied to the microprocessor-based controller 22 as a digital quantity. The composite signal from the sense amplifier 48 may also be applied to a demodulator circuit 54 whereby the modulation envelope is separated from the carrier, such that an impedance vs. time waveform is delivered over line 56 to the A/D converter 52. Once digitized, the impedance signal can be further signal processed, such as by first smoothing the waveform using a

6-point moving window, then windowing on a beat-to-beat basis with a fiducial point selectively chosen to focus on a predetermined portion of the cardiac cycle of interest. Ensemble averaging may also prove effective in emphasizing a particular feature of the impedance waveform. This further signal processing can be carried out in the analog domain, but preferably in the digital domain within the microprocessor 22.

As is explained in the aforereferenced Salo et al. patent, a signal proportional to cardiac output can be derived from the impedance vs. time signal and the cardiac output signal can, in turn, be used to optimize the pacing site or AV delay in a CHF therapy device or pacing rate in a rate adaptive cardiac rhythm management device.

The microprocessor 22 also controls a pulse generator 58 that is used to apply cardiac stimulating pulses to the heart via selected electrodes on one or the other of the leads 12, 14 and 15. The particular electrodes, again, are selected by the microprocessor 22 controlling the switch matrix 42.

By locating electrodes on the left side of the heart, via the coronary sinus/vein lead, the electric field created by the impedance sensing circuitry can be localized in the left ventricle, resulting in improved measurement of left ventricle stroke volume, determination of ejection fraction, rate of filling and a measure of the amount of mitral valve regurgitation present. The ability to select the site where impedance sensing takes place will also afford a way of timing different cardiac features for diagnostic or control purposes.

Studies using the present invention have shown that if the AC carrier signal is applied between electrodes RV1 and RA1 and with the sense amplifier connected to electrodes RV2 and CS2 as in Figure 2(a), timing features of the cardiac cycle, e.g., the time of the beginning of ejection, can be determined. This arrangement also affords the additional advantage that only one electrode would be

required on the coronary sinus lead which translates to a relatively small outside diameter of the lead for placement in a myocardial vein on the left side of the heart. Alternatively, if electrodes RV1 and RV2 are used for the current sources and with the sense signal picked up between electrodes CS2 and CS3, as in Figure 2(b), changes in left ventricular volume are enhanced. Here again, only two electrodes would be required on the coronary sinus lead which also portends a small diameter configuration.

10 It is also contemplated that the drive source can be connected across electrodes CS1 and CS4 and with sensing across electrodes CS2 and CS3. See Figure 2(c). While this configuration requires four electrodes, both stroke volume and timing features peculiar to the left ventricle can be more readily derived than when driving and sensing both occur in the right ventricle. Since four electrodes are required to implement this configuration, it may prove best for acute studies only. Such acute studies can be used to determine which configuration is best for a particular patient and then chronic leads having only the number of electrodes needed to achieve the optimum results need be chronically implanted.

25 It is also possible to measure interchamber impedance with the configuration shown in Figure 2(d). In this arrangement, the current (drive) source is connected to one of at least two electrodes on the coronary sinus/vein lead and to one of the at least two electrodes on the right ventricular lead. The sense amplifier is connected to one of the other electrodes on the coronary sinus lead and to one of the other electrodes on the right ventricular lead. This configuration requires only two bipolar (two electrode) leads and, since the sensing electrodes span the left ventricle, is sensitive to ventricular volume and wall motion.

35 Another measurement of chamber impedance can be generated by the configuration shown in Figure 2(e). In this arrangement, the current source is connected to an

electrode in the right atrium and to an electrode in the right ventricle. The electrical potential field generated by the current source is detected by a sense amplifier connected to two electrodes on a lead in a coronary vein. 5 This configuration is similar to that of Figure 2(b), but requires only unipolar (single electrode) leads in the right ventricle and right atrium. This arrangement like that of Figure 2(b) is most useful for following changes in left ventricular wall thickness and for extracting timing 10 information from wall thickness changes.

The use of a left coronary vein lead in conjunction with other sites in the right ventricular cardiac chamber has been found to greatly improve the ability of impedance plethysmography to sense both timing and volume features in 15 the cardiac cycle. Given the mechanical constraint imposed on the lead by the coronary vein, motion artifacts are significantly reduced. Configurations incorporating electrodes on both the coronary vein lead and the right ventricular lead permit the measurement of impedances 20 between different chambers and also along different current paths. This makes it possible to select combinations with improved signal-to-noise ratio to significantly improve the quality of the impedance measurement.

This invention has been described herein in 25 considerable detail in order to comply with the patent statutes and to provide those skilled in the art with the information needed to apply the novel principles and to construct and use such specialized components as are required. However, it is to be understood that the 30 invention can be carried out by specifically different equipment and devices, and that various modifications, both as to the equipment and operating procedures, can be accomplished without departing from the scope of the invention itself.

35 What is claimed is:

CLAIMS

1. A method of carrying out impedance plethysmography on a living heart, comprising the steps of:
- (a) installing a first lead having a plurality of electrodes in a right ventricular chamber of said living heart;
 - (b) installing a second lead having a plurality of electrodes in a coronary vein on the left ventricle of said heart;
 - 10 (c) coupling an AC drive signal between selected ones of the electrodes on the first and second leads;
 - (d) coupling a signal sensing circuit between at least one electrode on the second lead and another selected one of the electrodes on one of the first and second leads;
 - 15 and
 - (e) extracting a signal representative of electrical impedance from the signal sensing circuit.
2. A method for carrying out impedance plethysmography on a living heart, comprising the steps of:
- 20 (a) installing a first lead including at least two electrodes in a right ventricular chamber of said heart;
 - (b) installing a second lead including a plurality of electrodes in a coronary vein on the left ventricle of the heart;
 - 25 (c) coupling an AC drive signal source between one of
 - (i) the at least two electrodes on the first lead,
 - 30 (ii) one of the at least two electrodes on the first lead and a first of the plurality of electrodes on the second lead,
 - (iii) the first and a second of the plurality of electrodes on the second lead;
 - 35 (d) coupling a signal sensing circuit between

-12-

(i) a third and a fourth electrode on the second lead when the AC drive signal is coupled to the at least two electrodes on the first lead,

(ii) the other of the at least two electrodes on the first lead and the first of the plurality of the electrodes on the second lead when the AC drive signal is coupled to one of the at least two electrodes on the first lead and the third of the plurality of electrodes on the second lead,

(iii) the third and fourth of the plurality of electrodes on the second lead when the AC drive signal is coupled to the first and second of the plurality of electrodes on the second lead; and

(e) extracting a signal representative of electrical impedance from the signal sensing circuit.

3. A method for carrying out impedance plethysmography comprising the steps of:

(a) installing a first lead including at least two electrodes in a right ventricular chamber of said heart;

(b) installing a second lead including a plurality of electrodes in a coronary vein on the left ventricle of the heart;

(c) installing a third lead having an electrode in a right atrial chamber of the heart;

(d) coupling an AC drive signal source between one of:

(i) the at least two electrodes on the first lead,

(ii) one of the at least two electrodes on the first lead and a first of the plurality of electrodes on the second lead,

(iii) the first and a second of the plurality of electrodes on the second lead,

(iv) the electrode on the third lead and one of the electrodes on the first lead;

(e) coupling a signal sensing circuit between:

(i) a third and a fourth of the plurality of electrodes on the second lead when the AC drive signal is coupled to the at least two electrodes on the first lead,

5 (ii) the other of the at least two electrodes on the first lead and the third of the plurality of electrodes on the second lead when the AC drive signal is coupled to one of the at least two electrodes on the first lead and a third of the plurality of electrodes on
10 the second lead,

(iii) the third and a fourth of the plurality of electrodes on the second lead when the AC drive signal is coupled to the first and second of the plurality of electrodes on the second lead,

15 (iv) the first and the third of the plurality of electrodes on the second lead or the other electrode on the first lead and the third of the plurality of electrodes on the second lead when the AC drive signal is coupled to the electrode on the third lead and one of
20 the electrodes on the first lead; and

(f) extracting a signal representative of the electrical impedance from the signal sensing circuit.

4. A method for carrying out impedance plethysmography on a living heart, comprising the steps of:

25 (a) installing a first lead in a right ventricle of the heart, the first lead including at least two electrodes RV_1 and RV_2 thereon disposed in the right ventricle;

30 (b) installing a second lead in a coronary vein on the left ventricle of the heart, the second lead including a plurality of electrodes including at least two of CS_1 , CS_2 , CS_3 and CS_4 thereon;

35 (c) coupling an AC drive signal source and a signal sensing circuit to predetermined pairs of said electrodes in accordance with an entry in the following table:

AC DRIVE SOURCE	SENSING CIRCUIT
RV ₁ , RV ₂	CS ₂ , CS ₃
CS ₁ , CS ₄	CS ₂ , CS ₃
RV ₂ , CS ₁	RV ₁ , CS ₂

5 and;

(d) extracting a signal representative of electrical impedance from the signal sensing circuit.

5. The method of Claim 4 and further including the steps of:

10 (a) installing a third lead in a right atrial chamber, the third lead including an electrode RA₁ thereon; and

(b) coupling the AC drive signal source and the sensing circuit to predetermined pairs of said electrodes
 15 in accordance with an entry in the following table:

AC Drive Source	Sensing Circuit
RA ₁ , RV ₁	RV ₂ , CS ₂
RA ₁ , RV ₁	CS ₁ , CS ₂
RV ₁ , RV ₂	CS ₂ , CS ₃
20 CS ₁ , CS ₄	CS ₂ , CS ₃
RV ₂ , CS ₁	RV ₁ , CS ₂

6. An apparatus for conducting impedance plethysmography on a living heart, comprising:

25 (a) a first electrical lead having a plurality of electrodes adapted for placement in a coronary vein on the left ventricular chamber of said heart;

(b) a second lead having a plurality of electrodes and adapted for placement in a right ventricular chamber of the heart;

30 (c) means for applying an AC carrier signal across selected ones of said plurality of electrodes on one or both of the first and second electrical leads;

(d) means for sensing electrical signals connected across a pair of said plurality of electrodes

where at least one of said pair of electrodes is on the first electrical lead; and

(e) means connected to the sensing means for demodulating the sensed electrical signals.

AMENDED CLAIMS

[received by the International Bureau on 23 August 2000 (23.08.00);
original claims 1-5 cancelled; original claim 6 amended;
new claims 7-9 added (3 pages)]

CLAIMS

6. An apparatus for conducting impedance plethysmography on a living heart,
comprising:

5 (a) a first electrical lead (12) having a plurality of electrodes (RV₁ -
RV₄) adapted for placement in a coronary vein on the left ventricular chamber of said
heart;

(b) a second lead (14) having a plurality of electrodes (CS₁ - CS₄) and
adapted for placement in a right ventricular chamber of the heart;

10 (c) means (44) for applying an AC carrier signal across selected ones
of said plurality of electrodes on one or both of the first and second electrical leads;

(d) means (48) for sensing electrical signals connected across a pair of
said plurality of electrodes where at least one of said pair of electrodes is on the first
electrical lead; and

15 (e) means (54) connected to the sensing means for demodulating the
sensed electrical signals.

7. Apparatus for carrying out impedance plethysmography on a living heart,
comprising:

20 (a) a first lead (12) having a plurality of electrodes (RV₁ - RV₄)
adapted for placement in a right ventricular chamber of said heart;

(b) a second lead (14) having a plurality of electrodes (CS₁ - CS₄)
adapted for placement in a coronary vein on the left ventricle of the heart;

(c) a source (44) of AC drive signals;

25 (d) a switching circuit (42) for connecting said source of AC drive
signals to selected ones of the electrodes on the first and second leads;

(e) a signal sensing circuit (48) coupled by the switching circuit to at
least one electrode on the second lead and another electrode on the second lead and
another electrode on one of the first and second leads (Figs. 2a, 2b, 2d and 2e); and

(f) a demodulator (54) coupled to the signal sensing circuit, the demodulator extracting a signal proportional to the electrical impedance between said at least one electrode on the second lead and said another electrode on one of the first and second leads.

5

8. An apparatus for carrying out impedance plethysmography on a living heart, comprising:

(a) a first electrical lead (12) having at least two electrodes (RV₁ - RV₂) thereon adapted for placement in the right ventricular chamber of said heart;

10

(b) a second electrical lead (14) having a plurality of electrodes (CS₁ - CS₄) thereon adapted for placement in a coronary vein on the left ventricle of said heart;

(c) a source of AC drive signals (44);

(d) a signal sensing circuit (48);

15

(e) a switching circuit (42) for connecting said source and said sensing circuit to the electrodes on the first and second leads in accordance with an entry in the following table:

AC DRIVE SOURCE	SENSING CIRCUIT	FIGURE
RV ₁ , RV ₄	CS ₂ , CS ₃	2b
CS ₁ , CS ₄	CS ₂ , CS ₃	2c
RV ₂ , CS ₁	RV ₁ , CS ₂	2d

and;

20

(f) a demodulator (54) coupled to the signal sensing circuit, the demodulator extracting a signal proportional to the electrical impedance between the electrodes to which the switching circuit has connected the sensing circuit.

9. The apparatus of claim 8 and further including:

(a) a third lead adapted for placement in the right atrium of the heart, the third lead including an electrode RA₁ thereon; said switching circuit connecting said source and said sensing circuit to the electrodes on the first, second and third leads in accordance with an entry in the following table:

5

AC DRIVE SOURCE	SENSING CIRCUIT	FIGURE
RA ₁ , RV ₁	RV ₂ , CS ₂	2a
RA ₁ , RV ₁	CS ₁ , CS ₂	2e

STATEMENT UNDER ARTICLE 19(1)

In response to the International Search Report, applicant hereby cancels original claims 1-5 and claim 6 is amended only to add reference numbers. Applicant offers the addition of new claims 7, 8 and 9 for consideration. The newly presented claims are believed to be within the scope of the invention described in the specification, and better recite the distinct inventive features with respect to the state of the art. The present claims are believed to more concisely distinguish over the documents considered to be relevant in the International Search Report.

It is believed that the present Amendment under Article 19 and Statement Under Article 19(1) are timely with respect to the publication date and will be made of record.

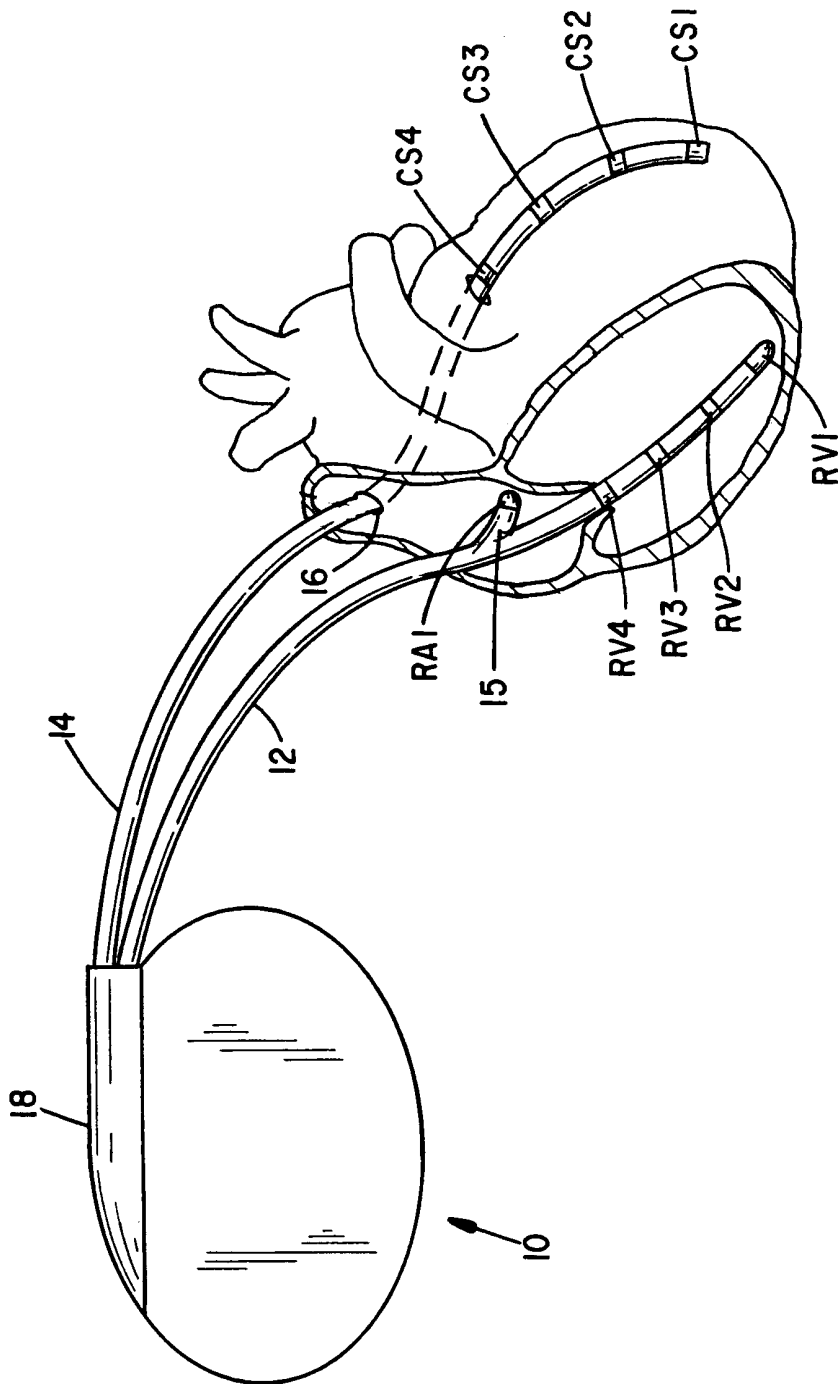

FIG. 1

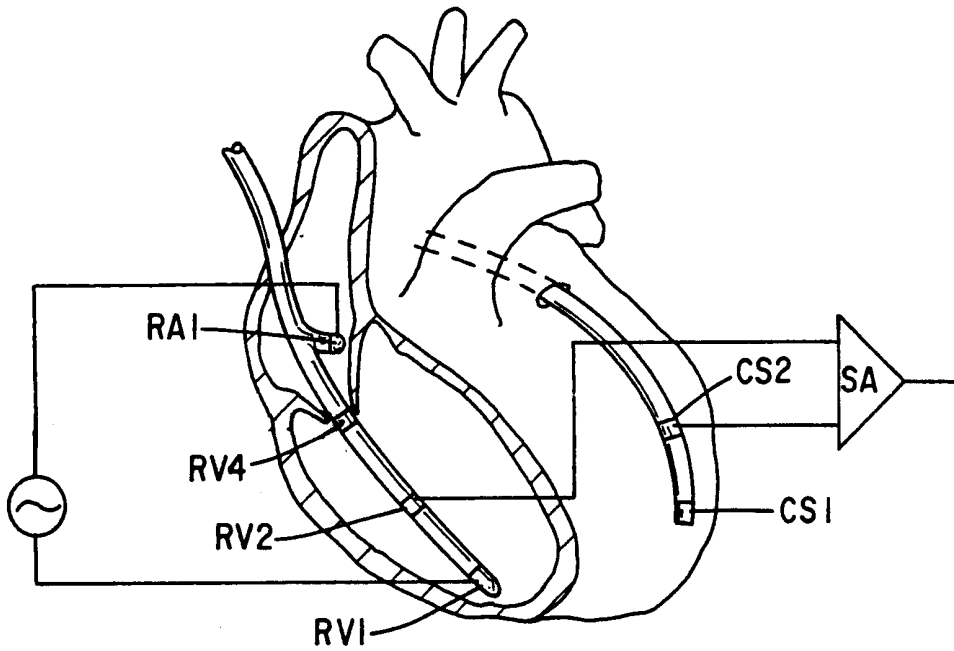

FIG. 2(a)

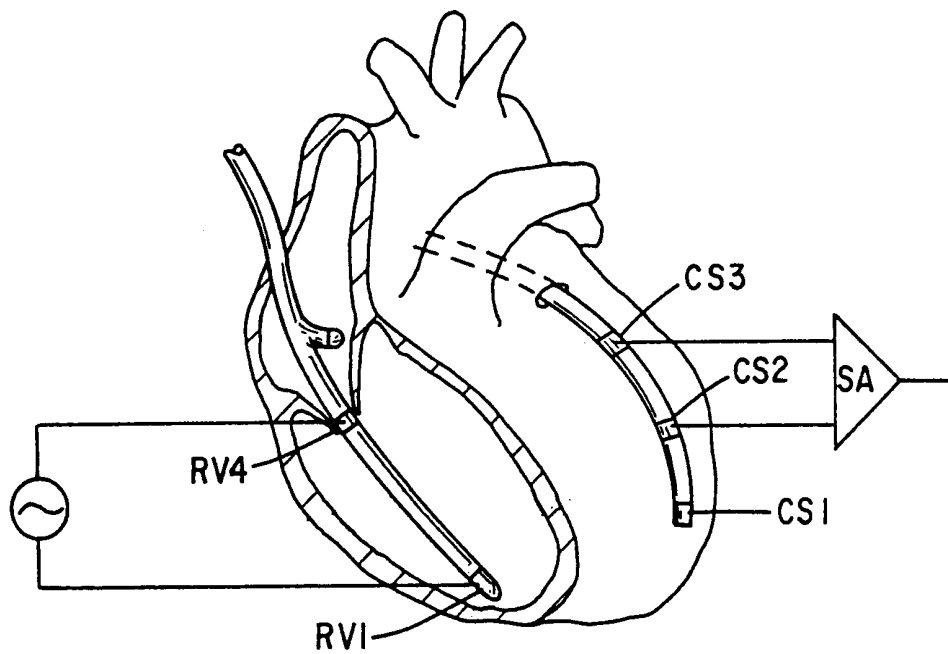

FIG. 2(b)

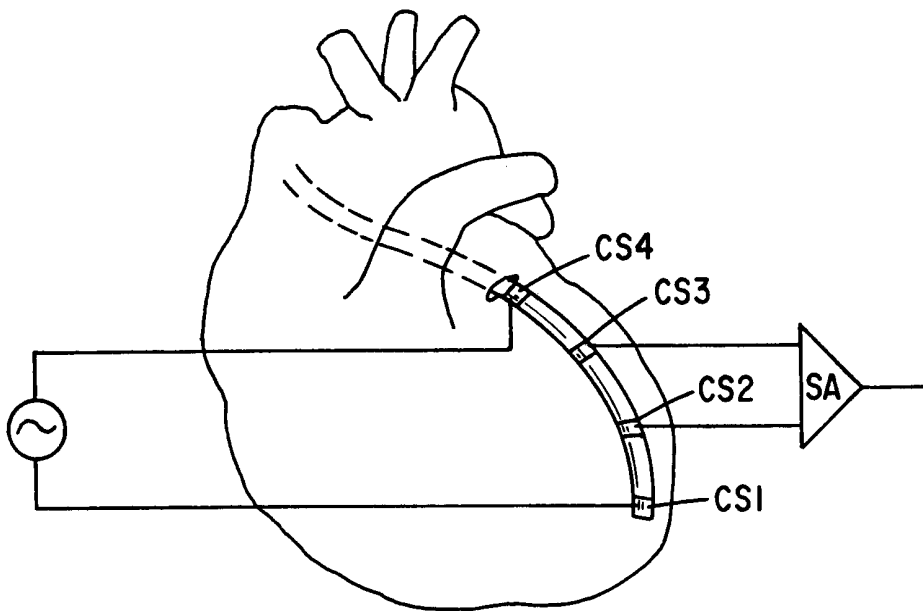

FIG. 2(c)

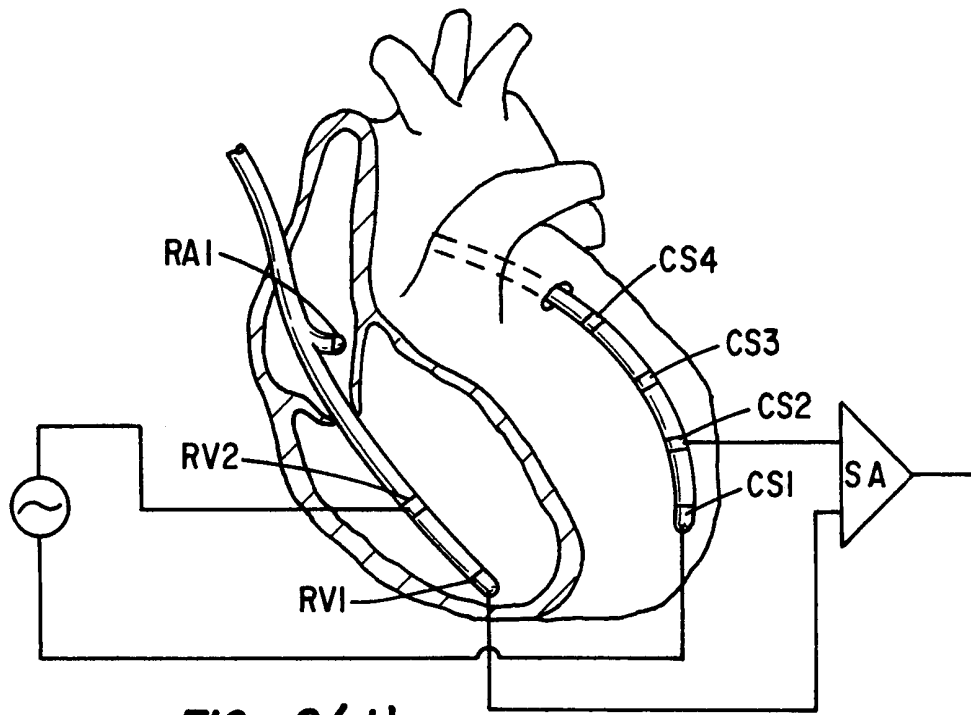

FIG. 2(d)

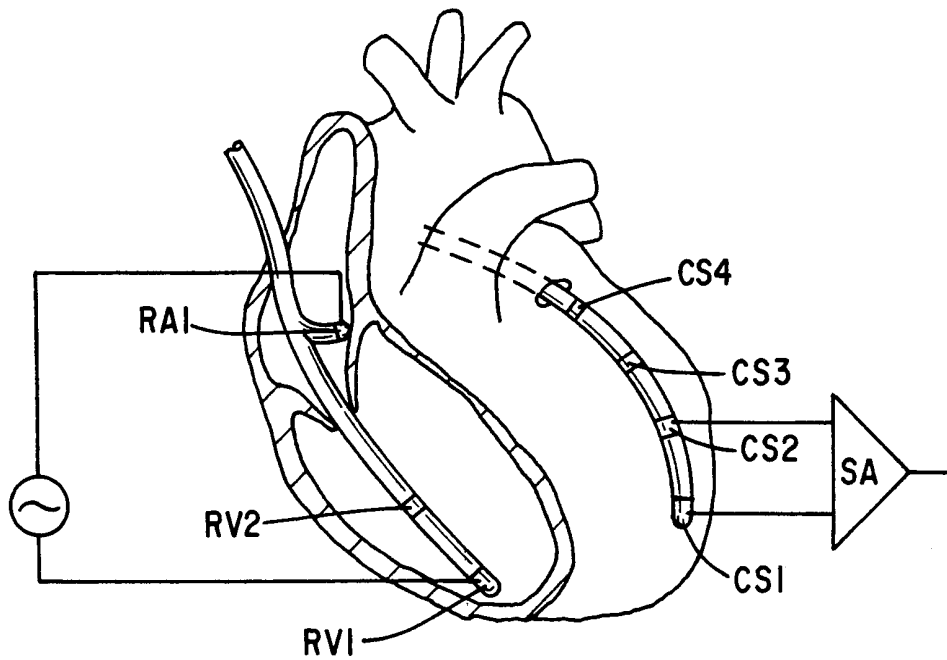

FIG. 2(e)

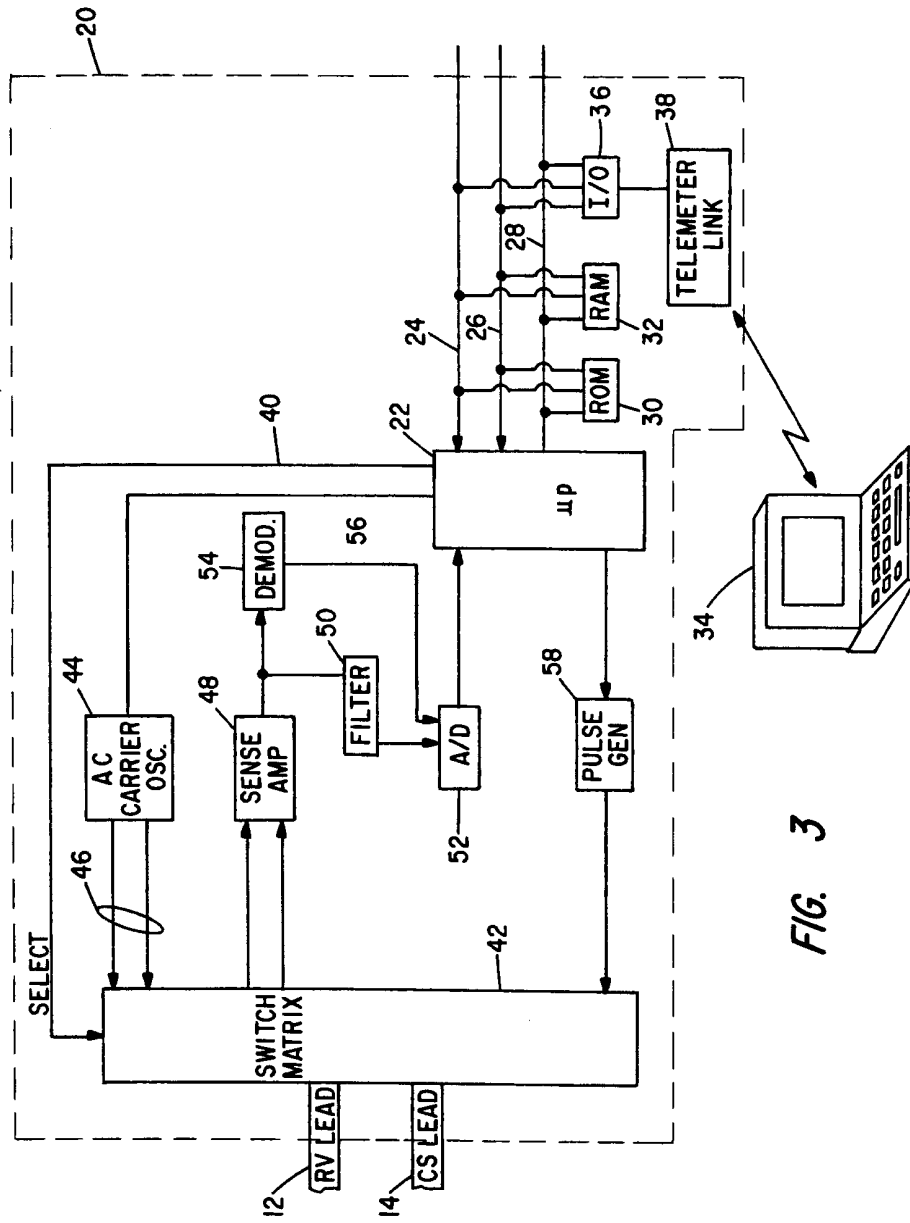

FIG. 3

INTERNATIONAL SEARCH REPORT

International Application No
PCT/US 00/12403

A. CLASSIFICATION OF SUBJECT MATTER
IPC 7 A61N1/365 A61B5/05

According to International Patent Classification (IPC) or to both national classification and IPC

B. FIELDS SEARCHED

Minimum documentation searched (classification system followed by classification symbols)
IPC 7 A61N A61B

Documentation searched other than minimum documentation to the extent that such documents are included in the fields searched

Electronic data base consulted during the international search (name of data base and, where practical, search terms used)

EPO-Internal, WPI Data

C. DOCUMENTS CONSIDERED TO BE RELEVANT

Category	Citation of document, with indication, where appropriate, of the relevant passages	Relevant to claim No.
P, X	WO 99 30777 A (ROOS CUBUS DE ;BAKELS ARNOLDUS (NL); LEINDERS ROBERT (NL); MEDTRON) 24 June 1999 (1999-06-24) page 5-16; claim 23; figures ---	6
Y	US 5 501 702 A (PLICCHI GIANNI ET AL) 26 March 1996 (1996-03-26) column 2, line 50 -column 8, line 16; figures 1,2,14-16; example 4 ---	6
Y	US 5 540 727 A (SALO RODNEY W ET AL) 30 July 1996 (1996-07-30) column 3, line 14 -column 5, line 26; claim 6; figures ---	6
A	WO 99 13941 A (SULZER INTERMEDICS INC) 25 March 1999 (1999-03-25) page 7-11; claim 1; figures 1-5 ---	6
	-/--	

Further documents are listed in the continuation of box C.

Patent family members are listed in annex.

° Special categories of cited documents :

- "A" document defining the general state of the art which is not considered to be of particular relevance
- "E" earlier document but published on or after the international filing date
- "L" document which may throw doubts on priority claim(s) or which is cited to establish the publication date of another citation or other special reason (as specified)
- "O" document referring to an oral disclosure, use, exhibition or other means
- "P" document published prior to the international filing date but later than the priority date claimed

- "T" later document published after the international filing date or priority date and not in conflict with the application but cited to understand the principle or theory underlying the invention
- "X" document of particular relevance; the claimed invention cannot be considered novel or cannot be considered to involve an inventive step when the document is taken alone
- "Y" document of particular relevance; the claimed invention cannot be considered to involve an inventive step when the document is combined with one or more other such documents, such combination being obvious to a person skilled in the art.
- "&" document member of the same patent family

Date of the actual completion of the international search

15 August 2000

Date of mailing of the international search report

22/08/2000

Name and mailing address of the ISA

European Patent Office, P.B. 5818 Patentlaan 2
NL - 2280 HV Rijswijk
Tel. (+31-70) 340-2040, Tx. 31 651 epo nl,
Fax: (+31-70) 340-3016

Authorized officer

Allen, E

INTERNATIONAL SEARCH REPORT

International Application No
PCT/US 00/12403

C.(Continuation) DOCUMENTS CONSIDERED TO BE RELEVANT		
Category °	Citation of document, with indication, where appropriate, of the relevant passages	Relevant to claim No.
A	US 5 235 976 A (SPINELLI JULIO C) 17 August 1993 (1993-08-17) column 4, line 49 -column 5, line 68; figures 1,2 -----	6

INTERNATIONAL SEARCH REPORT

Information on patent family members

International Application No

PCT/US 00/12403

Patent document cited in search report	Publication date	Patent family member(s)	Publication date
WO 9930777 A	24-06-1999	US 6070100 A AU 1714499 A	30-05-2000 05-07-1999
US 5501702 A	26-03-1996	IT 1272265 B	16-06-1997
US 5540727 A	30-07-1996	NONE	
WO 9913941 A	25-03-1999	EP 1015074 A	05-07-2000
US 5235976 A	17-08-1993	CA 2091708 A EP 0615770 A AU 3522493 A DE 69323543 D DE 69323543 T ES 2130222 T	17-09-1994 21-09-1994 29-09-1994 25-03-1999 08-07-1999 01-07-1999