



US00D726438S

(12) **United States Design Patent**
Morgan

(10) **Patent No.:** **US D726,438 S**

(45) **Date of Patent:** **** Apr. 14, 2015**

(54) **FLOWER POT**

(71) Applicant: **Scott N. Morgan**, Seattle, WA (US)

(72) Inventor: **Scott N. Morgan**, Seattle, WA (US)

(**) Term: **14 Years**

(21) Appl. No.: **29/464,777**

(22) Filed: **Aug. 21, 2013**

(51) **LOC (10) Cl.** **06-06**

(52) **U.S. Cl.**

USPC **D6/404**

(58) **Field of Classification Search**

USPC D6/403-405, 556-559, 570;
D11/143-156, 164; D19/77, 80, 81,
D19/84; D25/15, 100, 105, 113; D26/9, 10,
D26/11, 16, 19; D34/1, 2, 4-6; 47/17, 32.4,
47/32.5, 32.7, 33, 39, 41.01, 41.1,
47/41.11-41.15, 44-47, 63, 65.5, 65.9,
47/66.6, 66.7, 67-71; D8/1

See application file for complete search history.

(56) **References Cited**

U.S. PATENT DOCUMENTS

| | | | |
|------------|-----------|-------------|---------------|
| D106,131 S | 9/1937 | Butler | |
| D176,798 S | 1/1956 | Klingberg | |
| D189,856 S | 3/1961 | Doran | |
| D246,637 S | * 12/1977 | Kawade | D11/149 |
| D296,607 S | * 7/1988 | Iber | D2/898 |
| D340,006 S | 10/1993 | Barger, III | |
| D351,525 S | * 10/1994 | Alexander | D6/597 |
| D450,261 S | 11/2001 | Steere | |
| D565,459 S | 4/2008 | Fears | |

| | | | |
|------------------|---------|-----------------|-------------|
| D647,370 S | 10/2011 | van Dijk et al. | |
| D651,938 S | 1/2012 | Christie | |
| D653,474 S | 2/2012 | Garcia et al. | |
| 2013/0219589 A1* | 8/2013 | Jones | 2/227 |
| 2014/0165265 A1* | 6/2014 | Tulin et al. | 2/234 |

OTHER PUBLICATIONS

Jean Planters by Dad's Route 66 Blog. dated Jul. 17, 2011. found online [Oct. 24, 2014] <http://route66.mightyhorproductions.com/route66-dad/?p=922>.*

Holster detail by carrie dated Mar. 10, 2009. found online [Oct. 24, 2013] <https://www.flickr.com/photos/9102223@N07/3344163969>.*

* cited by examiner

Primary Examiner — Robert M Spear

Assistant Examiner — Marissa J Cash

(57) **CLAIM**

The ornamental design for a flower pot, as shown and described.

DESCRIPTION

FIG. 1 is a front view of a flower pot showing my new design; FIG. 2 is a rear view of the flower pot; FIG. 3 is a left side view of the flower pot; FIG. 4 is a right side view of the flower pot; FIG. 5 is a top view of the flower pot, a bottom view thereof having no ornamental features; and, FIG. 6 is a cross-sectional view taken along line 6-6 of FIG. 4 to show the depth of the container within the flower pot. The broken lines in the drawings represent unclaimed environmental subject matter and form no part of the claim.

1 Claim, 5 Drawing Sheets

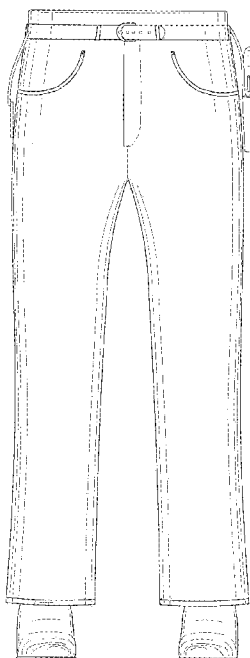

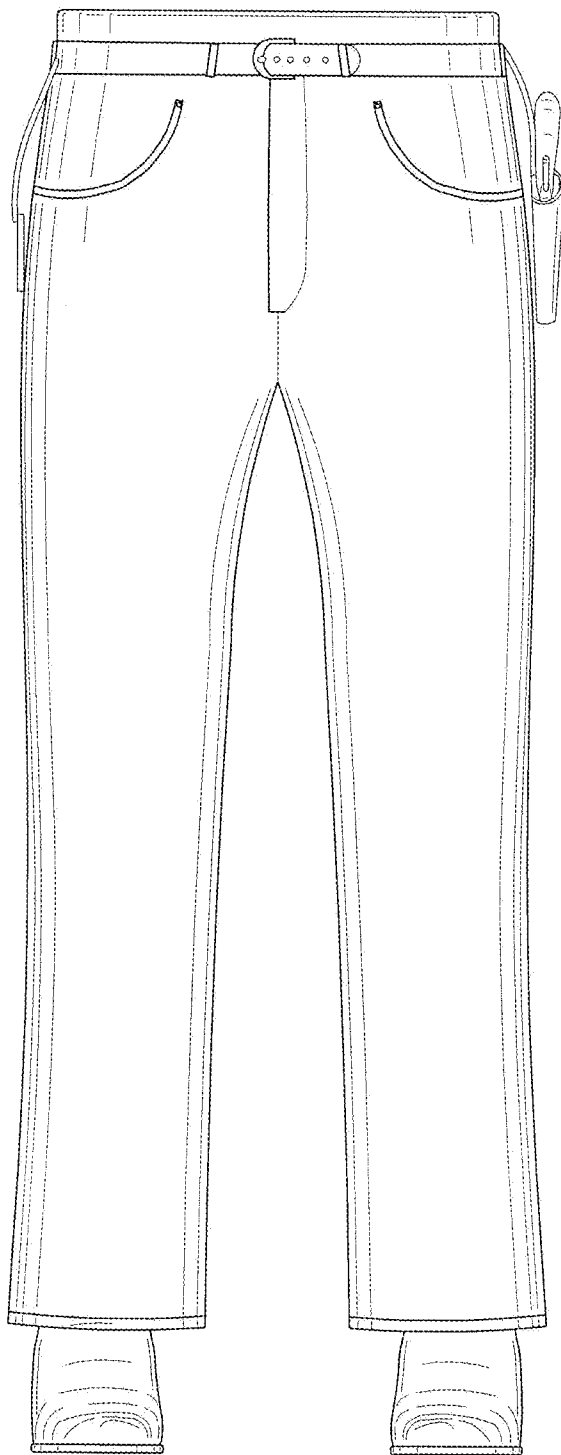

FIG. 1

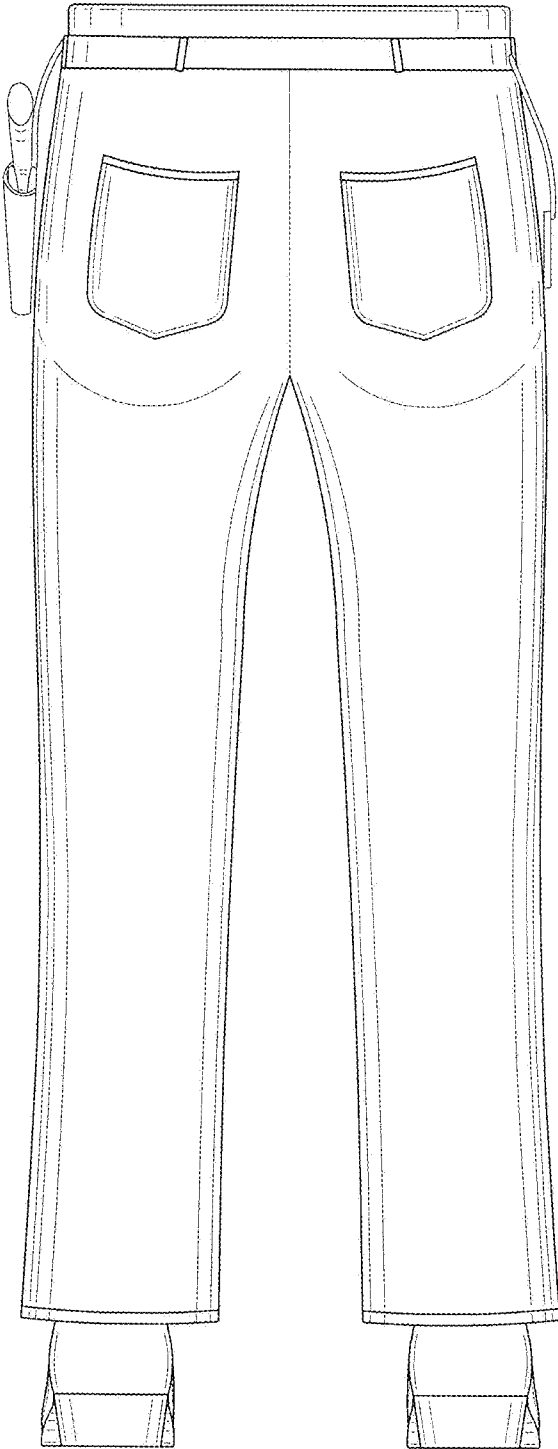

FIG. 2

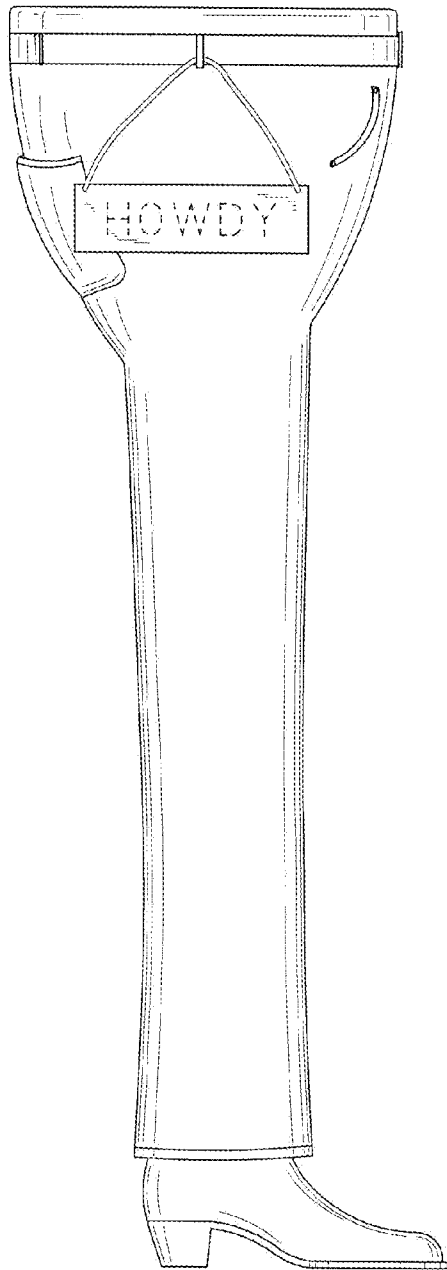

FIG. 3

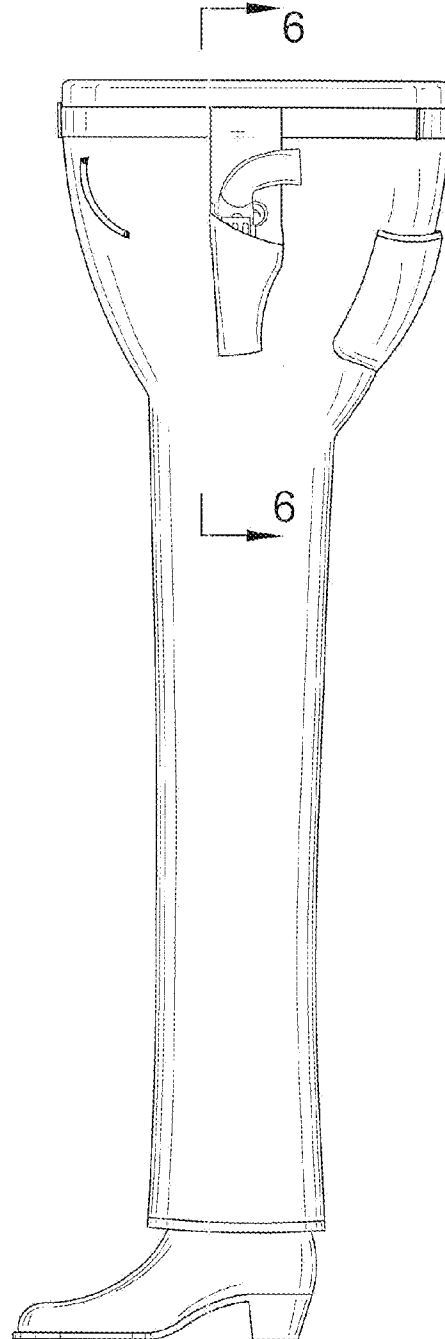

FIG. 4

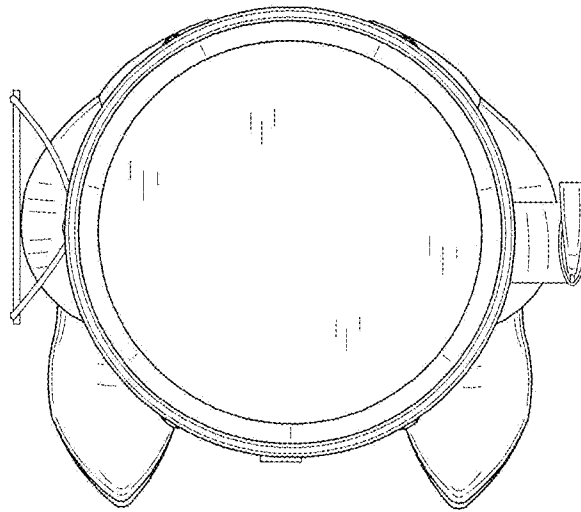

FIG. 5

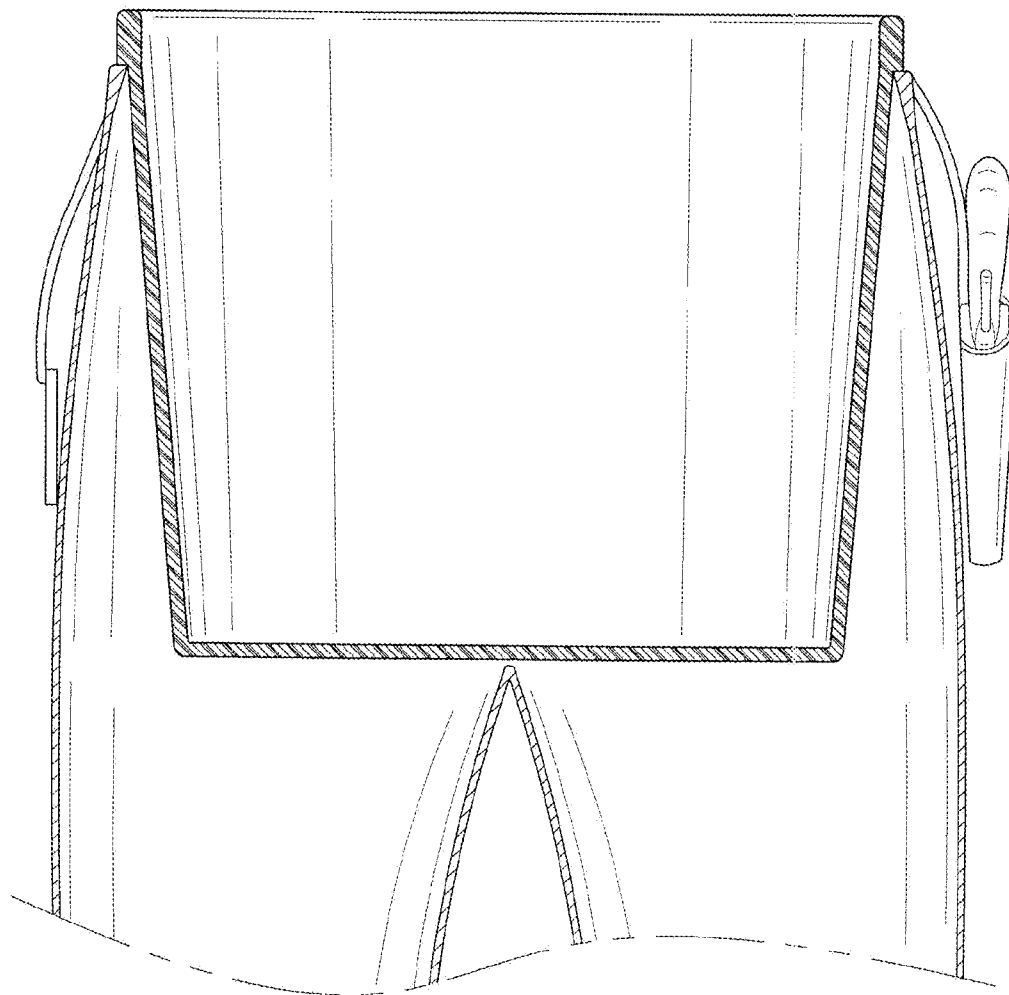

FIG. 6