

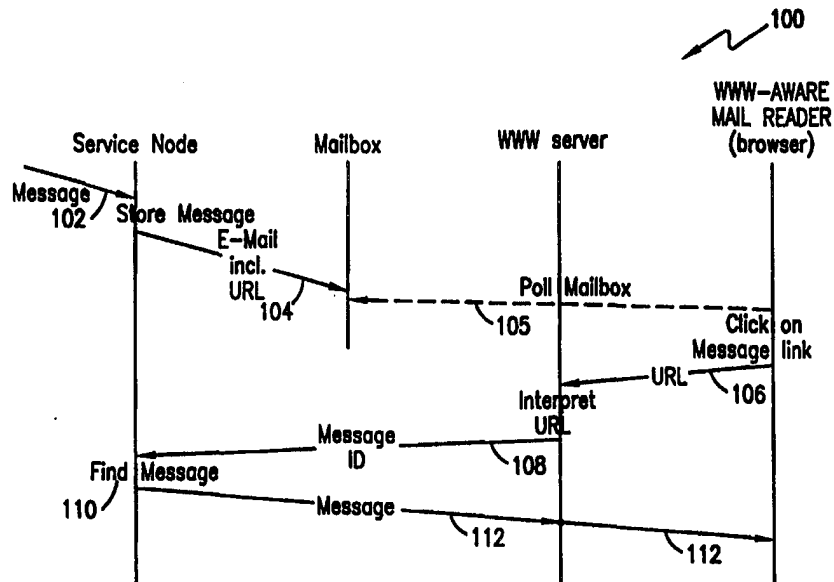

INTERNATIONAL APPLICATION PUBLISHED UNDER THE PATENT COOPERATION TREATY (PCT)

<p>(51) International Patent Classification ⁶ : G06F 17/60, H04M 3/50</p>	<p>A1</p>	<p>(11) International Publication Number: WO 98/58332 (43) International Publication Date: 23 December 1998 (23.12.98)</p>
<p>(21) International Application Number: PCT/SE98/01140 (22) International Filing Date: 12 June 1998 (12.06.98) (30) Priority Data: 08/877,065 17 June 1997 (17.06.97) US 09/092,132 5 June 1998 (05.06.98) US (71) Applicant: TELEFONAKTIEBOLAGET LM ERICSSON [SE/SE]; S-126 25 Stockholm (SE). (72) Inventors: ERIKSSON, Michael; Barks Väg 12, 2trp, S-170 73 Solna (SE). BÅGE, Göran; Byvägen 10, S-133 34 Saltsjö-Baden (SE). DANNE, Anders; Kastrupgatan 12, S-164 41 Kista (SE). (74) Agent: ERICSSON RADIO SYSTEMS AB; Common Patent Dept., S-164 80 Stockholm (SE).</p>	<p>(81) Designated States: AL, AM, AT, AU, AZ, BA, BB, BG, BR, BY, CA, CH, CN, CU, CZ, DE, DK, EE, ES, FI, GB, GE, GH, GM, GW, HU, ID, IL, IS, JP, KE, KG, KP, KR, KZ, LC, LK, LR, LS, LT, LU, LV, MD, MG, MK, MN, MW, MX, NO, NZ, PL, PT, RO, RU, SD, SE, SG, SI, SK, SL, TJ, TM, TR, TT, UA, UG, UZ, VN, YU, ZW, ARIPO patent (GH, GM, KE, LS, MW, SD, SZ, UG, ZW), Eurasian patent (AM, AZ, BY, KG, KZ, MD, RU, TJ, TM), European patent (AT, BE, CH, CY, DE, DK, ES, FI, FR, GB, GR, IE, IT, LU, MC, NL, PT, SE), OAPI patent (BF, BJ, CF, CG, CI, CM, GA, GN, ML, MR, NE, SN, TD, TG).</p> <p>Published <i>With international search report.</i></p>	

(54) Title: METHOD AND APPARATUS FOR ACCESSING AND RETRIEVING MESSAGES



(57) Abstract

A method and apparatus are disclosed in which a Uniform Resource Locator, which pinpoints an electronic message storage address or location, is embedded in or attached to an e-mail notification message sent to an intended recipient. Once notified, the intended recipient, in just one step, uses a WWW-aware mail reader (browser) to click on a link in the notification message window. The mail reader can thereby directly access the message storage location and retrieve the message for viewing or listening. In order to ensure that the embedded or attached Uniform Resource Locator is valid and has been received from a bona fide source, the Uniform Resource Locator can be tagged with a random encryption key. Also, an intended recipient of an electronically stored message can interactively elect to have the message delivered via a telephone connection instead of a data network.

FOR THE PURPOSES OF INFORMATION ONLY

Codes used to identify States party to the PCT on the front pages of pamphlets publishing international applications under the PCT.

AL	Albania	ES	Spain	LS	Lesotho	SI	Slovenia
AM	Armenia	FI	Finland	LT	Lithuania	SK	Slovakia
AT	Austria	FR	France	LU	Luxembourg	SN	Senegal
AU	Australia	GA	Gabon	LV	Latvia	SZ	Swaziland
AZ	Azerbaijan	GB	United Kingdom	MC	Monaco	TD	Chad
BA	Bosnia and Herzegovina	GE	Georgia	MD	Republic of Moldova	TG	Togo
BB	Barbados	GH	Ghana	MG	Madagascar	TJ	Tajikistan
BE	Belgium	GN	Guinea	MK	The former Yugoslav Republic of Macedonia	TM	Turkmenistan
BF	Burkina Faso	GR	Greece	ML	Mali	TR	Turkey
BG	Bulgaria	HU	Hungary	MN	Mongolia	TT	Trinidad and Tobago
BJ	Benin	IE	Ireland	MR	Mauritania	UA	Ukraine
BR	Brazil	IL	Israel	MW	Malawi	UG	Uganda
BY	Belarus	IS	Iceland	MX	Mexico	US	United States of America
CA	Canada	IT	Italy	NE	Niger	UZ	Uzbekistan
CF	Central African Republic	JP	Japan	NL	Netherlands	VN	Viet Nam
CG	Congo	KE	Kenya	NO	Norway	YU	Yugoslavia
CH	Switzerland	KG	Kyrgyzstan	NZ	New Zealand	ZW	Zimbabwe
CI	Côte d'Ivoire	KP	Democratic People's Republic of Korea	PL	Poland		
CM	Cameroon	KR	Republic of Korea	PT	Portugal		
CN	China	KZ	Kazakistan	RO	Romania		
CU	Cuba	LC	Saint Lucia	RU	Russian Federation		
CZ	Czech Republic	LI	Liechtenstein	SD	Sudan		
DE	Germany	LK	Sri Lanka	SE	Sweden		
DK	Denmark	LR	Liberia	SG	Singapore		
EE	Estonia						

METHOD AND APPARATUS FOR ACCESSING AND RETRIEVING MESSAGES

5 BACKGROUND OF THE INVENTION

Technical Field of the Invention

The present invention relates in general to the telecommunications field and, in particular, to methods and apparatuses for use in accessing and retrieving messages in response to e-mail notifications.

10

Description of Related Art

Most modern day telecommunication systems contain message centers, which are typically hardware-based facilities used to store voice messages, facsimile messages, e-mail messages, etc. These messages can be accessed and retrieved in a number of different ways that depend on the type of message stored. For example, a telephone can be used to retrieve a voice mail message from a voice mail message center, while a facsimile message is typically accessed and retrieved using a digital processor which is executing specialized facsimile software.

15

Digital processing systems that are executing specialized software programs are also used to access and retrieve e-mail messages from message centers (commonly referred to as "mailboxes"). These processing systems can take a number of different forms. For example, in a local area network (LAN), e-mail messages can be transferred between network users under the control of a centralized network server. Typically, the network server is specialized software, which is executed by a digital processor to perform the e-mail message transmission, storage, notification, accessing and receiving functions. The hardware that supports the network server provides the memory storage locations that comprise the network's message center or mailbox.

20

25

Essentially, there are numerous types of e-mail systems in use on LANs, wide area networks (WANs), mainframe systems, and public data networks. For example, a number of e-mail systems are in use that can transfer messages over the Internet.

30

- 2 -

These systems typically interface with the Internet in accordance with a standard message protocol called the "Simple Mail Transfer Protocol" (SMTP). The SMTP is an e-mail transfer protocol used primarily on the Internet, UNIX-based systems, and Transmission Control Protocol/Internet Protocol (TCP/IP) networks. This protocol is normally used when sending e-mail messages created by one user's mail software program (running on a host computer) to a recipient's mailbox. The SMTP defines the control messages used in sending the e-mail message, including such functions as verifying that the connection is proper, identifying the sender, negotiating the transmission parameters, and transmitting the message. Other known protocols are used when an e-mail message is retrieved from a mailbox and transferred to a recipient's mail software program. A more detailed description of the standard Internet (TCP/IP) message protocols can be found in the commonly known "Request For Comments" (RFCs).

One way that an Internet user can access and retrieve an e-mail message via the Internet is to use a World-Wide Web (WWW)-aware mail reader. For example, the Microsoft Internet Explorer and Netscape Navigator (commonly referred to as "browsers") are typical WWW-aware mail readers, which are software programs that operate on a user's computer. The mail reader can be used to access and retrieve documents (e.g., e-mail messages) from sites on the Internet and display them at the user's computer. An e-mail message is just one type of document that can be accessed and retrieved by such a mail reader, but the document retrieved in this instance is composed of text files.

The conventional method used to transfer e-mail messages from senders to recipients is called a "store and forward" method. When a user composes an e-mail message on a local computer, the user includes the address of the intended recipient. The user's return address is electronically affixed to the message. When the message is transmitted over the Internet, the intended recipient's address provides enough information about the message's final destination so that the various computers encountered on the Internet, each of which temporarily stores and then forwards the message, can determine where the message should go next. The message is transferred from computer to computer until it reaches its final destination, which is typically a

- 3 -

mailbox provided by the intended recipient's service provider. The service provider stores the incoming message in the destination mailbox. Typically, the intended recipient's mail software program polls the provider's server for new messages. These new messages can be e-mail notification messages about e-mail, voicemail, facsimile messages, missed calls, or any other type of electronic message. Once notified, the intended recipient can then take steps to retrieve the electronic message. In the case of an e-mail message, the intended recipient can start the WWW-aware mail reader and use it to follow the prescribed links to the correct e-mail message page, and then on to the message location. The mail reader can then be used to retrieve the message text for viewing at the intended recipient's computer.

More specifically, having received a notification of a new e-mail message, the typical procedure (assuming a Windows[®]-like environment) followed by an intended recipient to access and retrieve the new message is to start the WWW-aware mail reader and click on an e-mail icon with a mouse. The recipient then clicks on "read message" from a drop down menu. The next step is to click on the new message which is shown in the "inbox" (assuming the inbox is already selected). The new message is then retrieved by the mail reader for viewing at the recipient's monitor.

Similarly, having received an e-mail notification of a new voicemail message, the intended recipient typically dials the voicemail mailbox number, and inputs a series of numbers to access the voicemail message. However, a significant problem that arises when such access and retrieval procedures are followed is that they require numerous manual steps to complete, which results in a substantial and unnecessary expenditure of time and system resources.

The above-described process for using a WWW browser to access electronic messages via the Internet can have further disadvantages. For example, if the message to be retrieved is large, as is typical for voice and facsimile messages, two potential problems arise: transmission of the message to the intended recipient's terminal can require a disadvantageously long transmission time; and the recipient's terminal must have enough memory available to accommodate the entire message. Although streaming can be used for immediate response and to reduce memory use, inadequate bandwidth may prove to be a bottleneck when receiving voice messages.

It is therefore desirable to: reduce the time it takes to retrieve an electronic message; facilitate a user's access to an electronic message once notification of the message has been received; and minimize the use of system resources in accessing electronic messages.

5 It is further desirable to avoid the aforementioned disadvantages of using a browser to access long electronic messages.

The present invention provides a method and apparatus for embedding or attaching a Uniform Resource Locator (URL) which pinpoints the electronic message storage address or location, in or to the e-mail notification message sent to the
10 intended recipient. Once notified, the intended recipient can, in just one step, use a WWW-aware mail reader to click on a link in the notification message window. The mail reader can thereby directly access the message storage address or location and retrieve the message for viewing or listening by the recipient. In order to ensure that the embedded or attached URL is valid and has been received from a bona fide source,
15 the URL can be tagged with a random encryption key.

The invention also permits an intended recipient of a stored electronic message to interactively elect to have the message delivered via a telephone connection instead of a data network.

20 BRIEF DESCRIPTION OF THE DRAWINGS

FIGURE 1 is a simplified block diagram of an exemplary system that can be used to implement the method and apparatus of the present invention.

FIGURE 2 is a sequence diagram that illustrates an exemplary method that can be used for accessing and retrieving electronic messages from a public (or private) data
25 network, in accordance with the present invention.

FIGURE 3 shows an example of an e-mail notification message with an embedded URL, in accordance with the present invention.

FIGURE 4 is a block diagram of an exemplary system in which the present invention may be implemented.

- 5 -

FIGURE 5 is a flow diagram illustrating a process according to the present invention for accessing a stored electronic message via a message page and receiving the message via a telephone connection.

FIGURE 6 illustrates an exemplary message page according to the invention.

5 FIGURE 7 illustrates an entry from the FIGURE 6 message page in greater detail.

FIGURE 8 illustrates a window with which a message recipient can interactively designate a destination telephone number for delivery of a message.

10 FIGURE 9 is a flow diagram which illustrates exemplary operations of the browser of FIGURE 4.

FIGURE 10 is a sequence diagram illustrating an exemplary procedure according to the invention for effecting telephone delivery of an electronic message accessed from a message page.

15 FIGURE 11 is a flow diagram which illustrates exemplary operations of the message service node of FIGURE 4.

DETAILED DESCRIPTION OF THE DRAWINGS

Essentially, in a preferred embodiment, the time and resource problems associated with using a WWW-aware mail reader (e.g., browser) to follow the links
20 to the proper message location are resolved by embedding (or attaching) a URL, which pinpoints the message storage address, in (or to) the e-mail notification message sent to the intended recipient. Once notified, the intended recipient can, in just one step, use the WWW-aware mail reader to click on a link in the notification message window. The mail reader can thereby directly access the electronic message location
25 and retrieve the message for viewing or listening. In order to ensure that the embedded or attached URL is valid and has been received from a bona fide source, the URL can be tagged with a security key, such as, for example, a random encryption key. This security key is used when the message is to be retrieved. The key can be a "long" sequence of random bits, an encrypted bit string, or any appropriate
30 conventional type of security key. The key can be randomly generated using, for example, an "RSA" random key generation algorithm.

- 6 -

More specifically, FIGURE 1 is a simplified block diagram of an exemplary system that can be used to implement the method and apparatus of the present invention. In the preferred embodiments, the system (10) can include, for example, a service node 18 connected for two-way data communications with a public (or private) data network (e.g., LAN, WAN, Internet, etc.) 14. Node 18 can be, for example, a host processor, communications controller, server, workstation, personal computer, digital switch, gateway controller, or any other appropriate network-connected device that can function to transmit, receive and store e-mail and other electronic message data. In the preferred embodiments, service node 18 can be, for example, a mobile services switching center (MSC), a Gateway MSC (GMSC), or a home location register (HLR) in a Public Land Mobile Network (PLMN). In a different embodiment, service node 18 can be a central exchange in a wireline network such as a Public Switched Telephone Network (PSTN), or an MSC in a packet switched data network.

A user (e.g., message recipient) can communicate with the network 14 by the use of specialized software (12) running on a digital processor. In the preferred embodiments, the software is preferably a WWW-aware mail reader (e.g., browser, such as, for example, Microsoft's Internet Explorer or Netscape's Navigator), which can run on the recipient's personal computer. Alternatively, the mail reader can reside and run in any appropriate wireless terminal (e.g., a fixed or mobile terminal in a PLMN). The network 14 is connected for two-way data communications with a network server 16. In the preferred embodiments, server 16 is preferably a conventional WWW server.

FIGURE 2 is a sequence diagram that illustrates an exemplary method that can be used for accessing and retrieving electronic messages from a public (or private) data network, in accordance with a preferred embodiment of the present invention. Referring to FIGURES 1 and 2, the method (100) begins at step 102, when a new electronic message arrives and is stored in the service node 18 (e.g., at a specific location in a message center in the service node). At step 104, the service node 18 embeds or appends a URL in or to an e-mail notification message, which is to notify the intended recipient that a new electronic message has arrived and identify the

- 7 -

precise address or location of the stored message in that network (e.g., in the service node 18). The e-mail notification message is then transferred to the intended recipient's mailbox. This notification message is eventually noticed by the recipient's WWW-aware mail reader program 12. An example of an e-mail notification message with such an embedded URL is shown in FIGURE 3. The URL, for example, can be a link to a stored e-mail message, voicemail message, facsimile message, a link to send a facsimile message to a certain facsimile machine, a link to set up a phone call to a party who sent a voicemail message, or it can represent a URL-to-call back function implemented in a service node.

At step 105, the intended recipient's WWW-aware mail reader program 12 polls the mailbox and receives the notification e-mail (when the recipient's personal computer is on-line). Once notified about the new message, the recipient can activate the mail reader (12) and click on the message link in the notification window (step 106). At step 108, the WWW server 16 interprets the message identification and location information in the URL, and transfers the new message identification to the service node 18. At step 110, the service node 18 uses the message identification and location information (e.g., a link) to find the message at its precise location in the service node 18. At step 112, the service node transmits the new message to the WWW server 16, where it can be viewed via the recipient's web browser 12 (e.g., e-mail or a facsimile message) or heard (e.g. voicemail).

FIGURE 4 illustrates diagrammatically a system similar to that of FIGURE 1, but differing from FIGURE 1 in that the service node 18 is coupled to a conventional telecommunication station, such as a telephone or facsimile machine 41, via the public switched telephone network (PSTN), and is also coupled to a conventional wireless telecommunication device, such as a wireless telephone or facsimile machine, via a public land mobile radio network (PLMR). Using the example arrangement of FIGURE 4, a message recipient (or user) can use the web browser 12 to access an electronic message stored in the service node 18, and also direct the service node 18 to deliver the electronic message via a telephone link (PSTN or PLMR) to any of the devices indicated at 41 and 43. For example, the message recipient can direct the service node 18 to deliver the electronic message to a facsimile machine via PSTN.

- 8 -

As another example, the message recipient can direct the service node 18 to deliver the electronic message to a wireless telephone via PLMR.

FIGURE 5 shows one example of the aforementioned process of using the browser 12 to access an electronic message and to arrange to receive the message via a telephone connection to, for example, a telephone or facsimile machine. It is first
5 determined at 51 whether a message has been received. For example, the decision at 51 would be answered yes when the recipient's browser 12 polls the recipient's mailbox and receives a new e-mail notification message. Once notified about the new message, the recipient can, at 52, use the browser to follow the prescribed links to the
10 correct message page, as is conventional. FIGURE 6 illustrates one example of a message page displayed to the recipient by the browser 12. As shown in FIGURE 6, the message page (or message web page) includes a plurality of message entries which respectively provide information about a plurality of the recipient's messages.

FIGURE 7 illustrates in more detail an example of the message entries shown
15 in FIGURE 6. As illustrated in FIGURE 7, a typical message entry according to the present invention includes an information portion 71 which displays, for example, the sender of the message, the date and time that the message was received, the type of message (e.g., e-mail, voice mail, facsimile) and the length of the message. The message entry also includes a deliver button (or link) 72, a deliver by phone button (or
20 link) 73 and a skip button 74. If the message recipient clicks on the deliver button 72, then the message will be delivered via the data network 14 of FIGURE 4 in conventional fashion. If the message recipient clicks on the skip button 74, then the message will be skipped for the time being. If the message recipient clicks on the deliver by phone button 73, then the web browser 12 will send to the service node 18
25 a communication including the identification of the message to be delivered along with a URL which designates the telephone number of the destination to which the service node is to deliver the message via telephone.

Referring again to FIGURE 5, the step at 53 of choosing the phone link in the message page corresponds to the above-described clicking on the deliver by phone
30 button (or link) 73. After the phone link has been chosen in the message page (i.e., button 73 has been clicked on), at 54 the message is received at the designated

telephone, facsimile machine or other telecommunication station. Thereafter, notification of the next new message is awaited at 51.

The decision at 53 may depend on the message length shown in the FIGURE 7 message entry. That is, if the message is relatively long (e.g., exceeds an empirically predetermined length), then phone delivery may be chosen to avoid the above-described problems created by long messages. If phone delivery is not chosen at 53, then the data network is used for delivery at 56 and 57, as is conventional.

When the recipient clicks on the deliver by phone button 73 of FIGURE 7, the URL that is sent to the service node 18 via the network 14 will designate a predetermined (and previously programmed) telephone number to which the message is to be delivered by the service node. However, it is desirable to have the capability of selecting different telephone number destinations for delivery of different messages. Therefore, in another embodiment of the invention, when the message recipient clicks on the deliver by phone button 73, the browser 12 can present to the message recipient the exemplary window illustrated in FIGURE 8. If the recipient wishes to have the message delivered to a telephone number other than a predetermined default telephone number, then the recipient types in the desired telephone number at 81 and clicks on the deliver button (or link) 82. In this instance, the destination URL produced by the browser 12 will designate the telephone number at 81 as the desired destination for delivery of the message. If the recipient simply clicks on the deliver button 82 without entering a telephone number at 81, then the destination URL will designate the default telephone number to be the delivery destination, as described above with respect to FIGURE 7.

FIGURE 9 is a flow diagram which illustrates exemplary operations of the browser 12 in executing the deliver by phone options of FIGURES 7 and 8. The browser initially waits at 91 for the recipient to click on the deliver by phone button 73. When the recipient has clicked on the deliver by phone button 73, either the default telephone number is obtained at 94 (see broken line path), or the window of FIGURE 8 is presented to the recipient, in which case the browser determines at 92 whether or not a telephone number has been supplied at 81 in FIGURE 8. If so, then the phone number from 81 is obtained at 93. If no telephone number is supplied at 81

- 10 -

in FIGURE 8, then the default number is used at 94. Thereafter, at 95, either the default telephone number or the recipient-supplied telephone number is designated in the URL and, at 96, the message ID and URL are sent via data network 14 to the message node 18.

5 FIGURE 10 is a sequence diagram which illustrates an exemplary sequence that permits the message recipient to receive the message via one of the PSTN or PLMR of FIGURE 4. In FIGURE 10, the message is received and stored in the service node in conventional fashion at 120. When the recipient clicks on the phone link (for example, either button 73 of FIGURE 7 or button 82 of FIGURE 8) the
10 browser at 121 transmits to the server 16 (see FIGURE 4) via the network 14 message identification information and the destination URL designating the desired telephone number to which the message is to be delivered. At 122, the server relays the information to the service node via the network 14. The service node interprets the URL to determine the desired call destination, and then sets up a suitable telephone
15 connection to one of the devices 41 and 43 (see FIGURE 4) via one of PSTN and PLMR. Once the call has been set up at 123 and 124, the service node delivers the message via the telephone connection at 125.

 FIGURE 11 illustrates exemplary operations of the service node 18 in response to a request to deliver a message stored in the service node. If telephone delivery is
20 not selected at 131, then the service node performs the conventional delivery function at 132. If telephone delivery has been selected at 131, then it is determined at 133 whether or not the stored message is a facsimile message. If so, then the service node calls the selected facsimile machine and delivers the facsimile message at 134. If the message is not a facsimile message, it is then determined at 135 whether the message
25 is a voice message. If so, then the service node calls the desired telephone and delivers the voice message at 136.

 If the message is neither a facsimile message (133) nor a voice message (135), then the message is assumed to be e-mail or a text file (or files), so the service node will perform a suitable conversion of the message to voice (139) or facsimile (138)
30 depending whether the destination station is a facsimile receiver or a voice receiver (137). Thereafter, the service node 18 calls and delivers either a facsimile message at

- 11 -

134 or a voice message at 136. After either a voice message or a facsimile message is delivered at 136 or 134, the service node waits at 131 until the next request for telephone delivery is received from network 14.

5 Although exemplary embodiments of the present invention have been described above in detail, this does not limit the scope of the invention, which can be practiced in a variety of embodiments.

- 12 -

WHAT IS CLAIMED IS:

1. A method for use in accessing a message in a message storage location, comprising the steps of:
 - generating a notification message to notify an intended recipient of a receipt
5 of said message;
 - appending a uniform resource locator having a security key to said notification message, said uniform resource locator identifying said message storage location; and
 - transferring said notification message including said uniform resource locator to said intended recipient.
- 10 2. The method of Claim 1, further comprising the steps of accessing said message in said message storage location; and
retrieving said message for use by said intended recipient.
- 15 3. The method of Claim 1, wherein said message comprises a text message.
4. The method of Claim 1, wherein said message comprises an e-mail message.
- 20 5. The method of Claim 1, wherein said message comprises a voice message.
6. The method of Claim 1, wherein said message comprises a facsimile
25 message.
7. The method of Claim 1, wherein said message includes a URL-to-call-back function on a WWW server.
- 30 8. The method of Claim 2, wherein said accessing and retrieving steps are performed with a WWW-aware mail reader.

- 13 -

9. The method of Claim 1, wherein said uniform resource locator includes a security key.

5 10. The method of Claim 8, wherein said WWW-aware mail reader resides in a wireless terminal.

11. The method of Claim 1, wherein said appending step comprises attaching said uniform resource locator to said notification message.

10 12. The method of Claim 1, wherein said appending step comprises embedding said uniform resource locator in said notification message.

13. The method of Claims 1-10, wherein said notification message comprises an e-mail message.

15

14. A system for use in accessing a message in a message storage location, comprising:

20 means for appending a uniform resource locator having a security key to a notification message, said uniform resource locator identifying said message storage location;

means for transferring said notification message to an intended recipient; and
means for accessing said message in said message storage location using said uniform resource locator.

25 15. The system of Claim 14, further comprising means for retrieving said message for display to said intended recipient.

16. The system of Claim 14, wherein said message comprises a text message.

30

- 14 -

17. The system of Claim 14, wherein said message comprises an e-mail message.
18. The system of Claim 14, wherein said message comprises a voice message.
19. The system of Claim 14, wherein said message comprises a facsimile message.
20. The system of Claim 14, wherein said message includes a URL-to-call back function on a WWW server.
21. The system of Claim 14, wherein said notification message comprises an e-mail message.
22. The system of Claim 14, wherein said means for accessing said message includes means for running a software browser.
23. The system of Claim 14, wherein said uniform resource locator includes a security key.
24. The system of Claim 14, wherein said means for accessing said message includes a wireless terminal.
25. A method of retrieving a message that is stored electronically at a storage apparatus, comprising:
- receiving via a data network, at a notification location physically remote from the storage apparatus, a notification that the message is available to be retrieved from the storage apparatus; and
 - responsive to receipt of the notification at the notification location, sending from the notification location to the storage apparatus, via the data network, a

- 15 -

communication indicating that the message is to be delivered via a telephone connection.

5 26. The method of Claim 25, including specifying a destination telephone number which identifies a telecommunication station to which the message is to be delivered via the telephone connection.

10 27. The method of Claim 26, wherein said specifying step includes providing in the communication a uniform resource locator that designates the destination telephone number.

 28. The method of Claim 26, wherein said specifying step includes using a WWW browser to specify the destination telephone number.

15 29. The method of Claim 26, wherein said telecommunication station is a voice receiving station, and including delivering the message to the voice receiving station.

20 30. The method of Claim 29, including converting the stored message into a voice message and delivering the converted voice message to the voice receiving station.

25 31. The method of Claim 26, wherein said telecommunication station is a facsimile receiving station, and including delivering the message to the facsimile receiving station via the telephone connection.

30 32. The method of Claim 31, including converting the stored message into a facsimile message, and delivering the converted facsimile message to the facsimile receiving station via the telephone connection.

- 16 -

33. The method of Claim 25, including determining the message length of the stored message, said sending step including sending the communication responsive to the message length exceeding a predetermined length.

5 34. The method of Claim 25, wherein the stored message is a voice message.

35. The method of Claim 25, wherein the stored message is a facsimile message.

10

36. The method of Claim 25, wherein the stored message is an e-mail message.

15 37. The method of Claim 25, wherein the telephone connection includes a wireless connection.

38. An apparatus for use in retrieving a message stored electronically at a physically remote storage apparatus, comprising:

20 means for receiving via a data network a notification that the message is available to be retrieved from the storage apparatus; and

 means responsive to the notification for sending to the storage apparatus via the data network a communication indicating that the message is to be delivered via a telephone connection.

25 39. The apparatus of Claim 38, including means for permitting a user to specify a destination telephone number which identifies a telecommunication station to which the message is to be delivered via the telephone connection.

30 40. The apparatus of Claim 39, wherein the telecommunication station includes a facsimile receiver.

- 17 -

41. The apparatus of Claim 39, wherein the telecommunication station includes a voice receiver.

5 42. The apparatus of Claim 39, wherein said communication includes a uniform resource locator that designates said destination telephone number.

43. The apparatus of Claim 38, including means for indicating whether the stored message is a voice message.

10 44. The apparatus of Claim 38, including means for indicating whether the stored message is a facsimile message.

45. The apparatus of Claim 38, including means for indicating a message length of the stored message.

15 46. The apparatus of Claim 38, wherein said telephone connection includes a wireless connection.

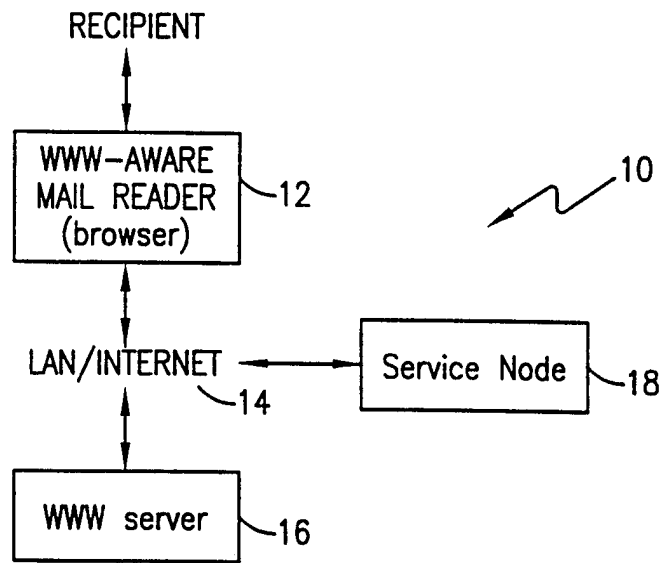

FIG. 1

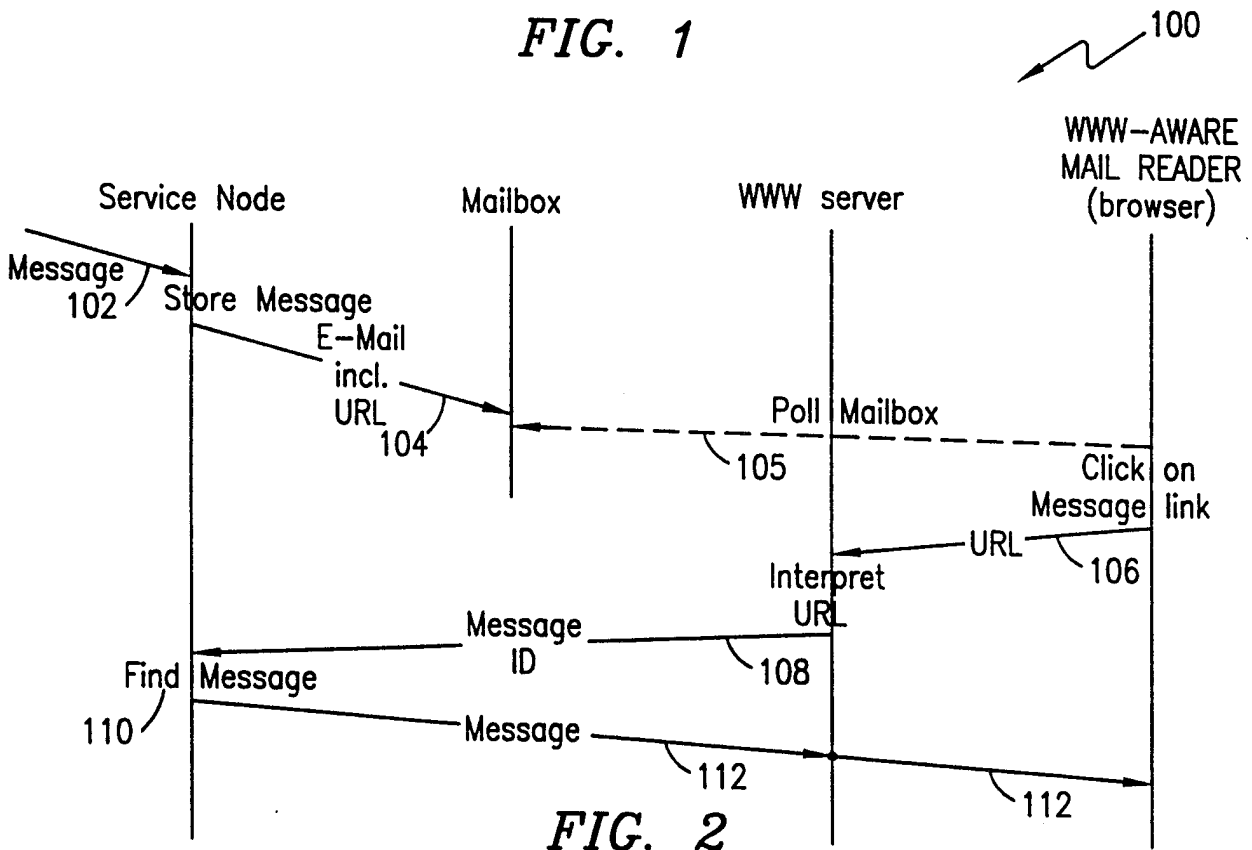

FIG. 2

Listen:

<http://okanagan.ericsson.se:8000/cgi-bin/get-mail.pe?UID=erabage&REF=OFNzr&TY:>

Call:

<http://okanagan.ericsson.se:8000/cgi-bin/make-call.pe?UID=erabage&nr=1003>

FIG. 3

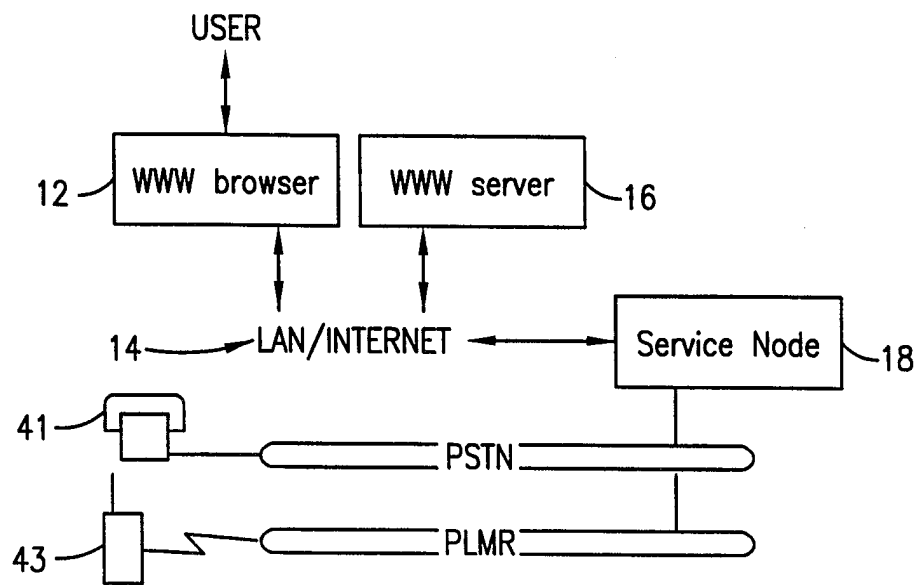

FIG. 4

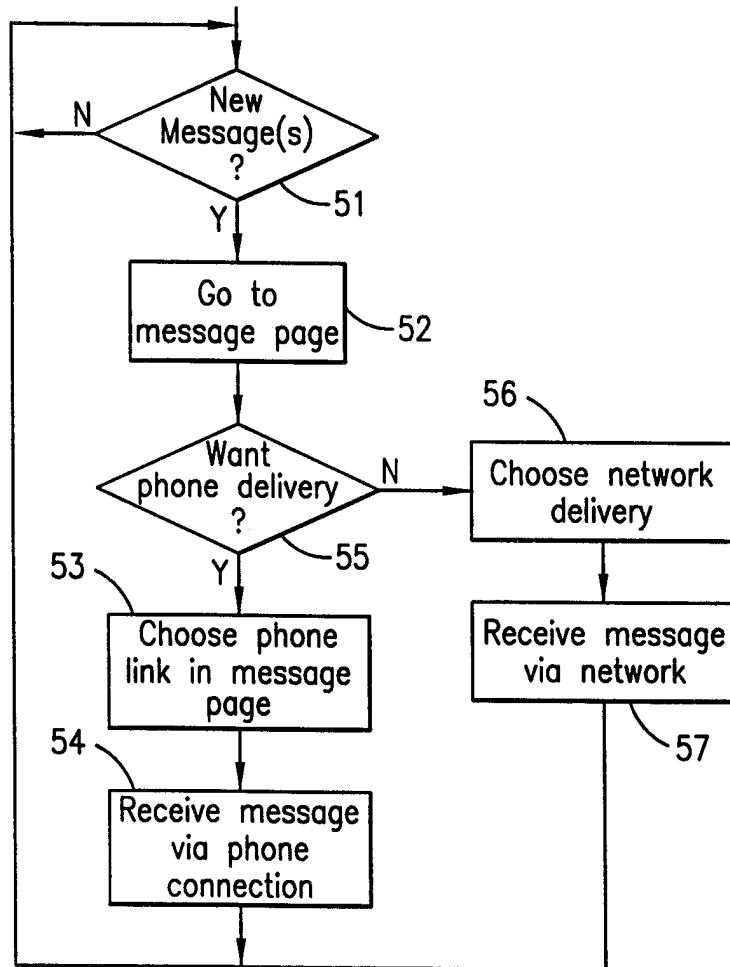

FIG. 5

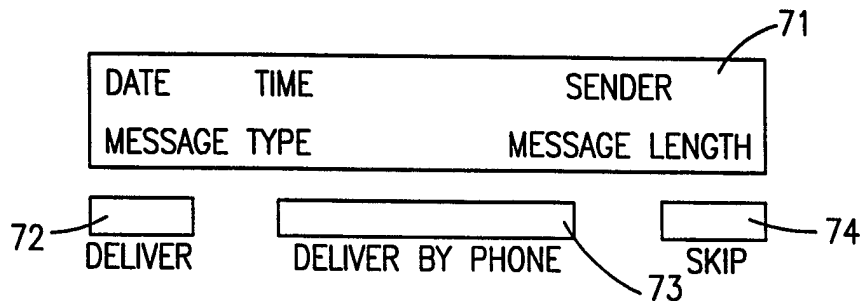

FIG. 7

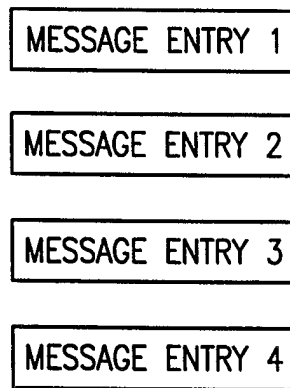

FIG. 6

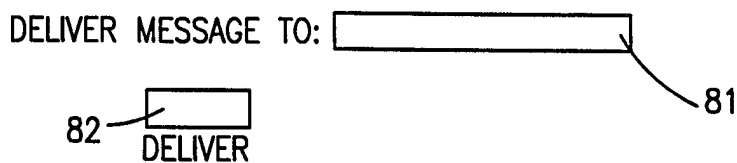

FIG. 8

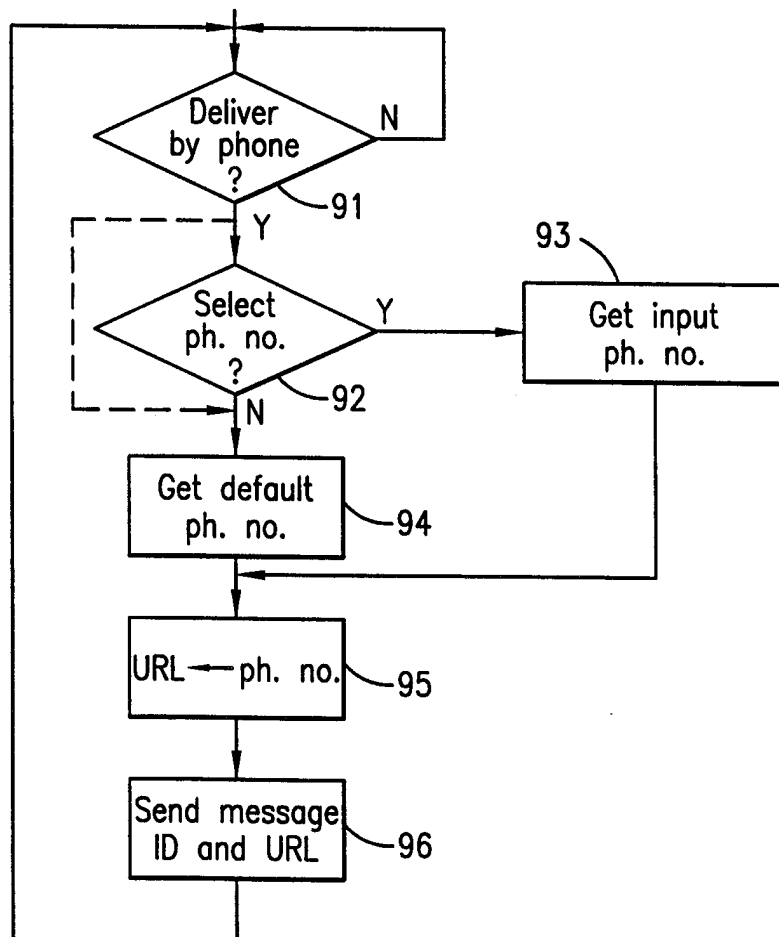

FIG. 9

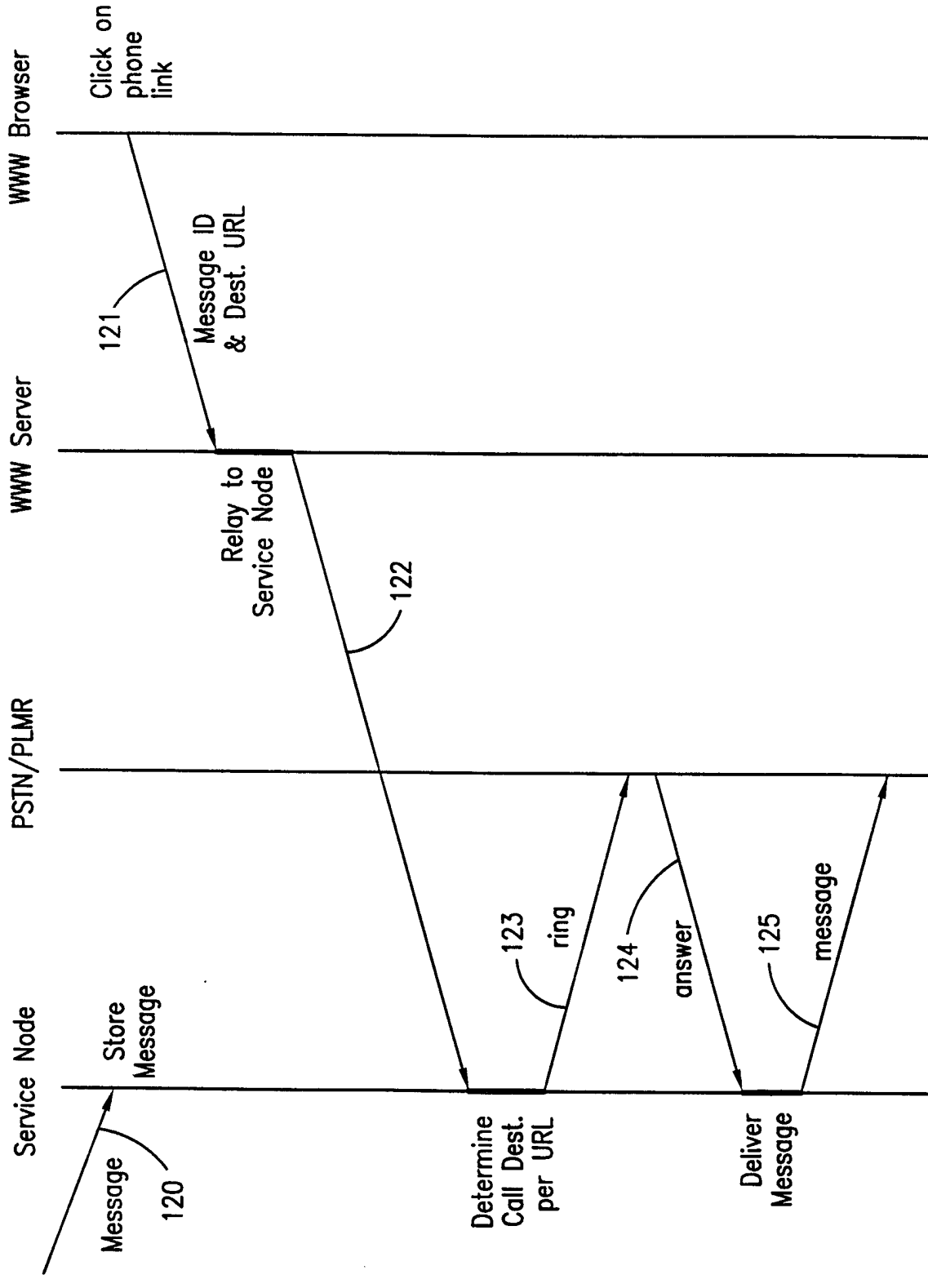

FIG. 10

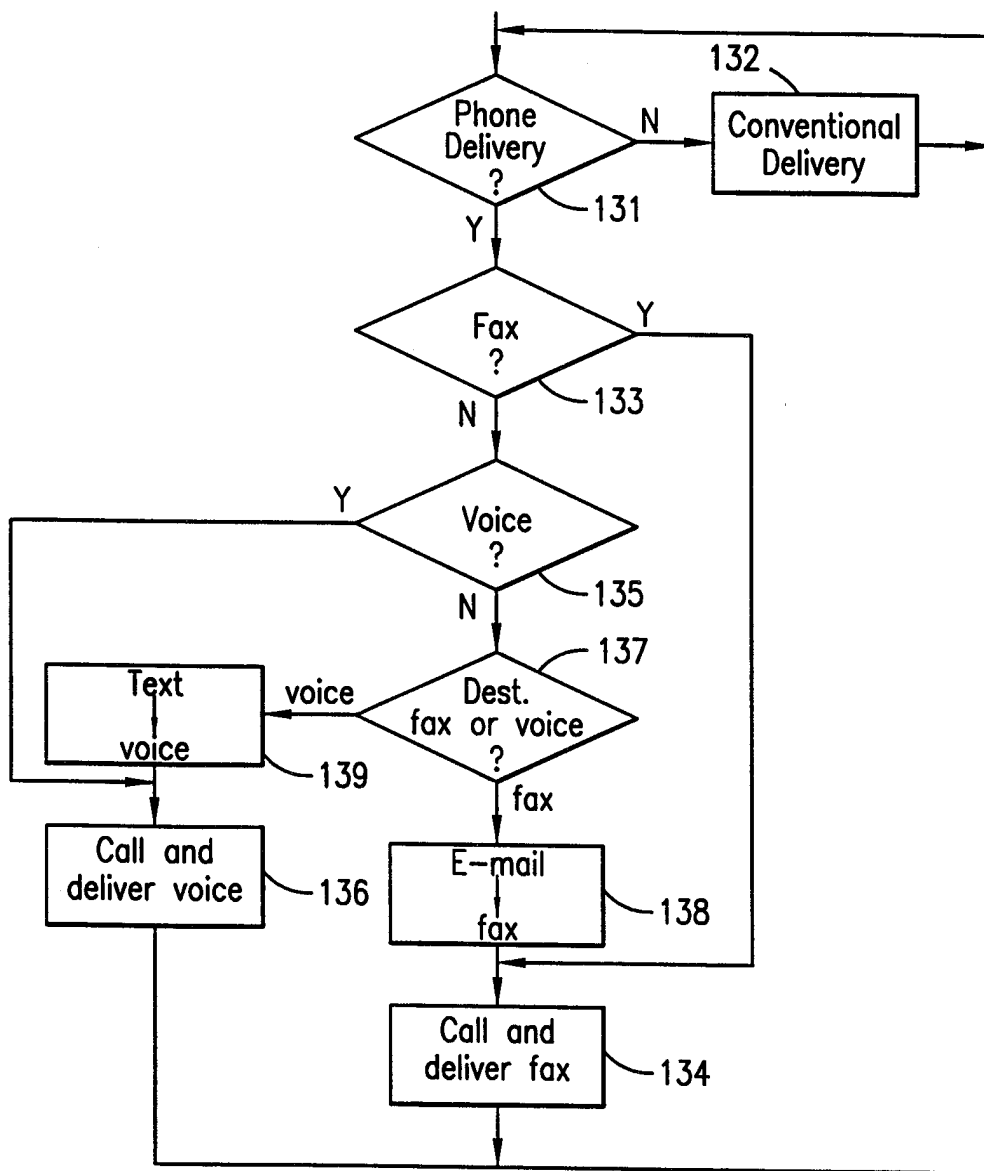

FIG. 11

INTERNATIONAL SEARCH REPORT

International Application No

PCT/SE 98/01140

A. CLASSIFICATION OF SUBJECT MATTER
 IPC 6 G06F17/60 H04M3/50

According to International Patent Classification (IPC) or to both national classification and IPC

B. FIELDS SEARCHED

Minimum documentation searched (classification system followed by classification symbols)
 IPC 6 G06F H04M

Documentation searched other than minimum documentation to the extent that such documents are included in the fields searched

Electronic data base consulted during the international search (name of data base and, where practical, search terms used)

C. DOCUMENTS CONSIDERED TO BE RELEVANT

Category	Citation of document, with indication, where appropriate, of the relevant passages	Relevant to claim No.
A	WO 96 31826 A (HIGLEY THOMAS K) 10 October 1996 see page 1, line 1 - page 5, line 17 ---	1-4, 8, 11-17, 21, 25, 38
A	WO 87 07801 A (AMERICAN TELEPHONE & TELEGRAPH) 17 December 1987 see page 1, line 1 - page 2, line 16; claims 1,5,6,9,10; figures 1,3,4 ---	1, 14, 25, 26, 29, 30, 34, 36, 38, 41, 43
P, A	EP 0 794 650 A (IBM) 10 September 1997 see column 1, line 1 - column 5, line 31	1, 14
P, X	see column 13, line 20 - line 40 ---	25, 38
	-/--	

Further documents are listed in the continuation of box C.

Patent family members are listed in annex.

Special categories of cited documents:

- "A" document defining the general state of the art which is not considered to be of particular relevance
- "E" earlier document but published on or after the international filing date
- "L" document which may throw doubts on priority claim(s) or which is cited to establish the publication date of another citation or other special reason (as specified)
- "O" document referring to an oral disclosure, use, exhibition or other means
- "P" document published prior to the international filing date but later than the priority date claimed

- "T" later document published after the international filing date or priority date and not in conflict with the application but cited to understand the principle or theory underlying the invention
- "X" document of particular relevance; the claimed invention cannot be considered novel or cannot be considered to involve an inventive step when the document is taken alone
- "Y" document of particular relevance; the claimed invention cannot be considered to involve an inventive step when the document is combined with one or more other such documents, such combination being obvious to a person skilled in the art.
- "&" document member of the same patent family

Date of the actual completion of the international search

29 September 1998

Date of mailing of the international search report

06/10/1998

Name and mailing address of the ISA

European Patent Office, P.B. 5818 Patentlaan 2
 NL - 2280 HV Rijswijk
 Tel. (+31-70) 340-2040, Tx. 31 651 epo nl,
 Fax: (+31-70) 340-3016

Authorized officer

Fournier, C

INTERNATIONAL SEARCH REPORT

I. International Application No
PCT/SE 98/01140

C.(Continuation) DOCUMENTS CONSIDERED TO BE RELEVANT		
Category °	Citation of document, with indication, where appropriate, of the relevant passages	Relevant to claim No.
A	US 5 144 557 A (WANG DIANA S ET AL) 1 September 1992 see column 2, line 12 - line 50; figure 3 ---	1-3, 14-17, 25,38
A	"DISTRIBUTING A DOCUMENT USING A REGIONAL REFERENCE" IBM TECHNICAL DISCLOSURE BULLETIN, vol. 33, no. 3A, 1 August 1990, page 251 XP000123925 see the whole document ---	1-3, 14-17, 25,38
A	WO 96 20553 A (ALPHANET TELECOM INC) 4 July 1996 see page 1, line 1 - page 6, line 30 -----	1-6, 14-19, 25,38

INTERNATIONAL SEARCH REPORT

Information on patent family members

International Application No
PCT/SE 98/01140

Patent document cited in search report	Publication date	Patent family member(s)	Publication date
WO 9631826 A	10-10-1996	US 5790793 A	04-08-1998
WO 8707801 A	17-12-1987	US 4837798 A	06-06-1989
		CA 1261493 A	26-09-1989
		CA 1270584 B	19-06-1990
		CN 1014666 B	06-11-1991
		EP 0270604 A	15-06-1988
		JP 2568602 B	08-01-1997
		JP 63503502 T	15-12-1988
EP 0794650 A	10-09-1997	GB 2310970 A	10-09-1997
		JP 9321914 A	12-12-1997
US 5144557 A	01-09-1992	EP 0471639 A	19-02-1992
		JP 1993558 C	22-11-1995
		JP 6067999 A	11-03-1994
		JP 7027499 B	29-03-1995
WO 9620553 A	04-07-1996	CA 2139081 A	24-06-1996
		AU 4294996 A	19-07-1996
		CN 1173260 A	11-02-1998
		EP 0799543 A	08-10-1997
		US 5608786 A	04-03-1997