

(19)



(11)

EP 1 259 643 B1

(12)

EUROPEAN PATENT SPECIFICATION

(45) Date of publication and mention of the grant of the patent:
15.10.2008 Bulletin 2008/42

(51) Int Cl.:
C12Q 1/68 (2006.01)

(21) Application number: **01910466.0**

(86) International application number:
PCT/US2001/004056

(22) Date of filing: **07.02.2001**

(87) International publication number:
WO 2001/057269 (09.08.2001 Gazette 2001/32)

(54) NUCLEIC ACID DETECTION METHODS USING UNIVERSAL PRIMING

NUKLEINSÄURE-NACHWEISVERFAHREN MIT UNIVERSELLEM PRIMING

PROCEDES DE DETECTION D'ACIDE NUCLEIQUE PAR AMORCAGE UNIVERSEL

(84) Designated Contracting States:
**AT BE CH CY DE DK ES FI FR GB GR IE IT LI LU
MC NL PT SE TR**

(56) References cited:
**WO-A-96/15271 WO-A-97/45559
WO-A-98/04746**

(30) Priority: **07.02.2000 US 180810 P
22.09.2000 US 234732 P**

- **IANNONE MARIE A ET AL: "Multiplexed single nucleotide polymorphism genotyping by oligonucleotide ligation and flow cytometry." CYTOMETRY, vol. 39, no. 2, 1 February 2000 (2000-02-01), pages 131-140, XP001073442 ISSN: 0196-4763**

(43) Date of publication of application:
27.11.2002 Bulletin 2002/48

- **LIZARDI P M ET AL: "MUTATION DETECTION AND SINGLE-MOLECULE COUNTING USING ISOTHERMAL ROLLING-CIRCLE AMPLIFICATION" NATURE GENETICS, NEW YORK, NY, US, vol. 19, no. 3, July 1998 (1998-07), pages 225-232, XP000856939 ISSN: 1061-4036**

(60) Divisional application:
08008155.7

- **BANER J ET AL: "Signal amplification of padlock probes by rolling circle replication" NUCLEIC ACIDS RESEARCH, OXFORD UNIVERSITY PRESS, SURREY, GB, vol. 26, no. 22, 15 November 1998 (1998-11-15), pages 5073-5078, XP002112357 ISSN: 0305-1048**

(73) Proprietor: **Illumina, Inc.
San Diego, California 92121-1975 (US)**

- **MAO Y W, LIANG, SONG, LI AND CHEN: "Construction of a DNA library from chromosome 4 of rice (Oryza sativa) by microdissection." CELL RESEARCH, vol. 8, no. 4, 1 December 1998 (1998-12-01), - 1 December 1997 (1997-12-01) pages 285-293, XP008034721**

(72) Inventors:
• **FAN, Jian-Bing
San Diego, CA 92130 (US)**
• **CHEE, Mark, S.
Del Mar, CA 92014 (US)**

(74) Representative: **Kiddle, Simon John et al
Mewburn Ellis LLP
23 Kingsway
London WC2B 6HP (GB)**

EP 1 259 643 B1

Note: Within nine months of the publication of the mention of the grant of the European patent in the European Patent Bulletin, any person may give notice to the European Patent Office of opposition to that patent, in accordance with the Implementing Regulations. Notice of opposition shall not be deemed to have been filed until the opposition fee has been paid. (Art. 99(1) European Patent Convention).

Description

FIELD OF THE INVENTION

5 **[0001]** The present invention is directed to providing sensitive and accurate assays for single nucleotide polymorphisms (SNPs) with a minimum or absence of target-specific amplification.

BACKGROUND OF THE INVENTION

10 **[0002]** The detection of specific nucleic acids is an important tool for diagnostic medicine and molecular biology research. Gene probe assays currently play roles in identifying infectious organisms such as bacteria and viruses, in probing the expression of normal and mutant genes and identifying mutant genes such as oncogenes, in typing tissue for compatibility preceding tissue transplantation, in matching tissue or blood samples for forensic medicine, and for exploring homology among genes from different species.

15 **[0003]** Ideally, a gene probe assay should be sensitive, specific and easily automatable (for a review, see Nickerson, Current Opinion in Biotechnology 4:48-51 (1993)). The requirement for sensitivity (i.e. low detection limits) has been greatly alleviated by the development of the polymerase chain reaction (PCR) and other amplification technologies which allow researchers to amplify exponentially a specific nucleic acid sequence before analysis (for a review, see Abramson et al., Current Opinion in Biotechnology, 4:41-47 (1993)).

20 **[0004]** Specificity, in contrast, remains a problem in many currently available gene probe assays. The extent of molecular complementarity between probe and target defines the specificity of the interaction.

[0005] Variations in the concentrations of probes, of targets and of salts in the hybridization medium, in the reaction temperature, and in the length of the probe may alter or influence the specificity of the probe/target interaction.

25 **[0006]** It may be possible under some circumstances to distinguish targets with perfect complementarity from targets with mismatches, although this is generally very difficult using traditional technology, since small variations in the reaction conditions will alter the hybridization. New experimental techniques for mismatch detection with standard probes include DNA ligation assays where single point mismatches prevent ligation and probe digestion assays in which mismatches create sites for probe cleavage. WO 96/15271 describes methods for amplifying a target nucleic acid sequence using split-probe reagents. WO 97/45559 describes methods of determining nucleic acid sequence differences using coupled ligase detection reaction and polymerase chain reaction.

30 **[0007]** Recent focus has been on the analysis of the relationship between genetic variation and phenotype by making use of polymorphic DNA markers. Previous work utilized short tandem repeats (STRs) as polymorphic positional marker; however, recent focus is on the use of single nucleotide polymorphisms (SNPs), which occur at an average frequency of more than 1 per kilobase in human genomic DNA. Some SNPs, particularly those in and around coding sequences, are likely to be the direct cause of therapeutically relevant phenotypic variants and/or disease predisposition. There are a number of well known polymorphisms that cause clinically important phenotypes; for example, the apoE2/3/4 variants are associated with different relative risk of Alzheimer's and other diseases (see Cordor et al., Science 261(1993). Multiplex PCR amplification of SNP loci with subsequent hybridization to oligonucleotide arrays has been shown to be an accurate and reliable method of simultaneously genotyping at least hundreds of SNPs; see Wang et al., Science, 40 280:1077 (1998); see also Schafer et al., Nature Biotechnology 16:33-39 (1998). The compositions of the present invention may easily be substituted for the arrays of the prior art.

[0008] Accordingly, it is an object of the invention to provide a very sensitive and accurate approach for genotyping with a minimum or absence of target-specific amplification.

45 BRIEF DESCRIPTION OF THE DRAWINGS

[0009]

50 Figures 1 to 6 are provided for reference.

Figure 7 depicts for reference a poly(A)-poly(T) capture to remove unhybridized probes and targets. Target sequence 5 comprising a poly(A) sequence 6 is hybridized to target probe 115 comprising a target specific sequence 70, an adapter sequence 20, an unstream universal priming site 25, and a downstream universal priming site 26. The resulting hybridization complex is contacted with a bead 51 comprising a linker 55 and a poly(T) capture probe 61.

55 Figure 8 depicts removing non-hybridized target probes, utilizing an OLA format Target 5 is hybridized to a first ligation probe 100 comprising a first target specific sequence 16, detection position 10, an adapter sequence 20, an unstream universal priming site 25, and an optional label 30, and a second ligation probe 110 comprising a

second target specific sequence 16, a downstream universal priming site 26, and a nuclease inhibitor 35. After ligation, denaturation of the hybridization complex and addition of an exonuclease, the ligated target probe 115 and the second ligation probe 110 is all that is left. The addition of this to an array (in this figure a bead array comprising substrate 40, bead 50 with linker 55 and capture probe 60 that is substantially complementary to the adapter sequence 20), followed by washing away of the second ligation probe 110 results in a detectable complex.

Figure 9 depicts a rolling circle utilizing two ligation probes. Target 5 is hybridized to a first ligation probe 100 comprising a first target specific sequence 15, detection position 10, an adapter sequence 20, an upstream universal priming site 25, an adapter sequence 20 and a RCA primer sequence 120, and a second ligation probe 110 comprising a second target specific sequence 16 and a downstream universal priming site 26. Following ligation, an RCA sequence 130 is added, comprising a first universal primer 27 and a second universal primer 28. The priming sites hybridize to the primers and ligation occurs, forming a circular probe. The RCA sequence 130 serves as the RCA primer for subsequent amplification. An optional restriction endonuclease site is not shown.

Figure 10 depicts for reference a rolling circle utilizing a single target probe. Target 5 is hybridized to a target probe 115 comprising a first target specific sequence 15, detection position 10, an adapter sequence 20, an upstream universal priming site 25, a RCA priming site 140, optional label sequence 150 and a second target specific sequence 16. Following ligation, denaturation, and the addition of the RCA primer and extension by a polymerase, amplicons are generated. An optional restriction endonuclease site is not shown.

SUMMARY OF THE INVENTION

[0010] The present invention provides a method of determining the identification of nucleotides at detection positions in target sequences, comprising:

a) providing a plurality of probe sets, wherein each set comprises:

- i) a first ligation probe comprising an upstream universal priming site and a first target-specific sequence; and
 - ii) a second ligation probe comprising a downstream universal priming site and a second target-specific sequence;
- wherein either the first or second target-specific sequence comprises a base at an interrogation position, and wherein at least one of said first and second ligation probes comprises an adapter sequence complementary to a capture probe on an array;

- b) hybridizing said plurality of probe sets to target sequences immobilized on a support or support, said target sequences each comprising a first target domain comprising a detection position and a second target domain adjacent to said detection position, wherein a first ligation probe comprising a sequence specific for the target hybridizes to the first target domain and a second ligation probe comprising a sequence specific for the target hybridizes to the second target domain, and wherein if said base at said interrogation position is perfectly complementary to a nucleotide at said detection position, a ligation complex is formed;
- c) providing a ligase that ligates said first and second ligation probes to form ligated probes;
- d) amplifying said ligated probes to generate a plurality of amplicons;
- e) contacting said amplicons with an array comprising capture probes on a solid support; and
- f) determining the nucleotide at each of said detection positions.

[0011] In addition comprising a method of determining the identification of a nucleotide at a detection position in target sequences, as set out in the claims hybridizing said ligated probes to a rolling circle (RC) sequence comprising:

an upstream priming sequence; and a downstream priming sequence; providing a ligase that ligates said upstream and downstream priming sites to form a circular ligated probe; amplifying said circular ligated probe to generate a plurality of amplicons; contacting said amplicons with an array of capture probes according to the claims, and determining the nucleotide at said detection position is described.

DETAILED DESCRIPTION OF THE INVENTION

[0012] The present invention is directed to the detection and quantification of a variety of nucleic acid reactions, particularly using microsphere arrays. In particular, the invention relates to genotyping, done using either genomic DNA, cDNA or mRNA, without prior amplification of the specific targets. In addition, the invention can be utilized with adapter

sequences to create universal arrays. In some embodiments, the invention further relates to the detection of genomic sequences and quantification (expression monitoring or profiling) of cDNA.

5 **[0013]** The detection and quantification of nucleic acids can be generally described as follows. A plurality of probes (sometimes referred to herein as "target probes") are designed to have at least three different portions: a first portion that is target-specific and two "universal priming" portions, an upstream and a downstream universal priming sequence. These target probes are hybridized to target sequences from a sample, without prior amplification, to form hybridization complexes. Non-hybridized sequences (both target probes and sample nucleic acids that do not contain the sequences of interest) are then removed. This is generally done in one of two ways: (1) either by using methods that can distinguish between single stranded and double stranded nucleic acids, for example by using intercalators on a support that preferentially bind double stranded nucleic acids; or (2) through the use of target specific sequences; for example, when the target sequences are mRNA transcripts with poly(A) tails, the use of poly(T) sequences on a support can preferentially retain all the hybrids. Once the unhybridized target probes are removed, the hybrids are denatured. All the target probes can then be simultaneously amplified using universal primers that will hybridize to the upstream and downstream universal priming sequences. The resulting amplicons, which can be directly or indirectly labeled, can then be detected on arrays, particularly microsphere arrays. This allows the detection and quantification of the target sequences, although in this embodiment, mRNA may not be preferred. Methods of the invention are as set out in the claims.

10 **[0014]** As will be appreciated by those in the art the systems can take on a wide variety of conformations, depending on the assay. An embodiment according to the present invention, for example when genotyping information is desired at a particular detection position in the target, is a variation of the above technique that utilizes the oligonucleotide ligation assay (OLA). OLA relies on the fact that two adjacently hybridized probes will be ligated together by a ligase only if there is perfect complementarity at each of the termini, i.e. at a detection position. In this embodiment, there are two ligation probes: a first or upstream ligation probe that comprises the upstream universal priming sequence and a second portion that will hybridize to a first domain of the target sequence, and a second or downstream ligation probe that comprises a portion that will hybridize to a second domain of the target sequence, adjacent to the first domain, and a second portion comprising the downstream universal priming sequence. If perfect complementarity at the junction exists, the ligation occurs and then the resulting hybridization complex (comprising the target and the ligated probe) can be separated as above from unreacted probes. Again, the universal priming sites are used to amplify the ligated probe to form a plurality of amplicons that are then detected in a variety of ways, as outlined herein. Alternatively, a variation on this theme utilizes rolling circle amplification (RCA), which requires a single probe whose ends are ligated, followed by amplification.

15 **[0015]** In addition, the above embodiments utilize one or more "adapter sequences" (sometimes referred to in the art as "zip codes") to allow the use of "universal arrays". That is, arrays are generated that contain capture probes that are not target specific, but rather specific to individual artificial adapter sequences. The adapter sequences are added to the target probes (in the case of ligation probes, either probe may contain the adapter sequence), nested between the priming sequences, and thus are included in the amplicons. The adapters are then hybridized to the capture probes on the array, and detection proceeds.

20 **[0016]** The present invention provides several significant advantages. The method can be used to detect genomic DNA or other targets from a single cell or a few cells because of signal amplification of annealed probes. It also allows the direct hybridization of the probes to genomic targets, if desired. Additionally, the hybridization reaction occurs on a surface, so that the reuse of immobilized target sequences with a different set or sets of target probes is possible.

25 **[0017]** Finally, the use of universal primers avoids biased signal amplification in PCR.

30 **[0018]** Accordingly, the present invention provides methods for detecting and genotyping specific target nucleic acid sequences in a sample. As will be appreciated by those in the art, the sample solution may comprise any number of things, including, but not limited to, bodily fluids (including, but not limited to, blood, urine, serum, lymph, saliva, anal and vaginal secretions, perspiration and semen, of virtually any organism, with mammalian samples being preferred and human samples being particularly preferred). The sample may comprise individual cells, including primary cells (including bacteria), and cell lines, including, but not limited to, tumor cells of all types (particularly melanoma, myeloid leukemia, carcinomas of the lung, breast, ovaries, colon, kidney, prostate, pancreas and testes), cardiomyocytes, endothelial cells, epithelial cells, lymphocytes (T-cell and B cell), mast cells, eosinophils, vascular intimal cells, hepatocytes, leukocytes including mononuclear leukocytes, stem cells such as haemopoetic, neural, skin, lung, kidney, liver and myocyte stem cells, osteoclasts, chondrocytes and other connective tissue cells, keratinocytes, melanocytes, liver cells, kidney cells, and adipocytes. Suitable cells also include known research cells, including, but not limited to, Jurkat T cells, NIH3T3 cells, CHO, Cos, 923, HeLa, WI-38, Weri-1, MG-63, etc. See the ATCC cell line catalog.

35 **[0019]** In addition, preferred methods utilize cutting or shearing techniques to cut the nucleic acid sample containing the target sequence into a size that will facilitate handling and hybridization to the target, particularly for genomic DNA samples. This may be accomplished by shearing the nucleic acid through mechanical forces (e.g. sonication) or by cleaving the nucleic acid using restriction endonucleases.

40 **[0020]** The present invention provides methods for detecting the presence or absence of target nucleic acid sequences in a sample. By "nucleic acid" or "oligonucleotide" or grammatical equivalents herein means at least two nucleotides

covalently linked together. A nucleic acid of the present invention will generally contain phosphodiester bonds, although in some cases, as outlined below, particularly for use with probes, nucleic acid analogs are included that may have alternate backbones, comprising, for example, phosphoramidate (Beaucage et al., *Tetrahedron* 49(10):1925 (1993) and references therein; Letsinger, *J. Org. Chem.* 35:3800 (1970); Sprinzl et al., *Eur. J. Biochem.* 81:579 (1977); Letsinger et al., *Nucl. Acids Res.* 14:3487 (1986); Sawai et al., *Chem. Lett.* 805 (1984); Letsinger et al., *J. Am. Chem. Soc.* 110:4470 (1988); and Pauwels et al., *Chemica Scripta* 26:141 91986)), phosphorothioate (Mag et al., *Nucleic Acids Res.* 19:1437 (1991); and U.S. Patent No. 5,644,048), phosphorodithioate (Briu et al., *J. Am. Chem. Soc.* 111:2321 (1989)), O-methylphosphoroamidite linkages (see Eckstein, *Oligonucleotides and Analogues: A Practical Approach*, Oxford University Press), and peptide nucleic acid backbones and linkages (see Egholm, *J. Am. Chem. Soc.* 114:1895 (1992); Meier et al., *Chem. Int. Ed. Engl.* 31:1008 (1992); Nielsen, *Nature*, 365:566 (1993); Carisson et al., *Nature* 380:207 (1996)). Other analog nucleic acids include those with positive backbones (Denpcy et al., *Proc. Natl. Acad. Sci. USA* 92:6097 (1995); non-ionic backbones (U.S. Patent Nos. 5,386,023, 5,637,684, 5,602,240, 5,216,141 and 4,469,863; Kiedrowski et al., *Angew. Chem. Intl. Ed. English* 30:423 (1991); Letsinger et al., *J. Am. Chem. Soc.* 110:4470 (1988); Letsinger et al., *Nucleoside & Nucleotide* 13:1597 (1994); Chapters 2 and 3, ASC Symposium Series 580, "Carbohydrate Modifications in Antisense Research", Ed. Y.S. Sanghui and P. Dan Cook; Mesmaeker et al., *Bioorganic & Medicinal Chem. Lett.* 4:395 (1994); Jeffs et al., *J. Biomolecular NMR* 34:17 (1994); *Tetrahedron Lett.* 37:743 (1996)) and non-ribose backbones, including those described in U.S. Patent Nos. 5,235,033 and 5,034,506, and Chapters 6 and 7, ASC Symposium Series 580, "Carbohydrate Modifications in Antisense Research", Ed. Y.S. Sanghui and P. Dan Cook. Nucleic acids containing one or more carbocyclic sugars are also included within the definition of nucleic acids (see Jenkins et al., *Chem. Soc. Rev.* (1995) pp169-176). Several nucleic acid analogs are described in Rawls, *C & E News* June 2, 1997 page 35. These modifications of the ribose-phosphate backbone may be done to facilitate the addition of labels, or to increase the stability and half-life of such molecules in physiological environments.

[0021] As will be appreciated by those in the art, all of these nucleic acid analogs may find use in the present invention. In addition, mixtures of naturally occurring nucleic acids and analogs can be made. Alternatively, mixtures of different nucleic acid analogs, and mixtures of naturally occurring nucleic acids and analogs may be made.

[0022] Particularly preferred are peptide nucleic acids (PNA) which includes peptide nucleic acid analogs. These backbones are substantially non-ionic under neutral conditions, in contrast to the highly charged phosphodiester backbone of naturally occurring nucleic acids. This results in two advantages. First, the PNA backbone exhibits improved hybridization kinetics. PNAs have larger changes in the melting temperature (T_m) for mismatched versus perfectly matched basepairs. DNA and RNA typically exhibit a 2-4°C drop in T_m for an internal mismatch. With the non-ionic PNA backbone, the drop is closer to 7-9°C. This allows for better detection of mismatches. Similarly, due to their non-ionic nature, hybridization of the bases attached to these backbones is relatively insensitive to salt concentration.

[0023] The nucleic acids may be single stranded or double stranded, as specified, or contain portions of both double stranded or single stranded sequence. Thus, for example, when the target sequence is a polyadenylated mRNA, the hybridization complex comprising the target probe has a double stranded portion, where the target probe is hybridized, and one or more single stranded portions, including the poly(A) portion. The nucleic acid may be DNA, both genomic and cDNA, RNA or a hybrid, where the nucleic acid contains any combination of deoxyribo- and ribo-nucleotides, and any combination of bases, including uracil, adenine, thymine, cytosine, guanine, inosine, xanthine, hypoxanthine, isocytosine, isoguanine, etc. A preferred embodiment utilizes isocytosine and isoguanine in nucleic acids designed to be complementary to other probes, rather than target sequences, as this reduces non-specific hybridization, as is generally described in U.S. Patent No. 5,681,702. As used herein, the term "nucleoside" includes nucleotides as well as nucleoside and nucleotide analogs, and modified nucleosides such as amino modified nucleosides. In addition, "nucleoside" includes non-naturally occurring analog structures. Thus for example the individual units of a peptide nucleic acid, each containing a base, are referred to herein as a nucleoside.

[0024] The methods of the invention are directed to the detection of target sequences. The term "target sequence" or "target nucleic acid" or grammatical equivalents herein means a nucleic acid sequence on a single strand of nucleic acid. The target sequence may be a portion of a gene, a regulatory sequence, genomic DNA, cDNA, RNA including mRNA and rRNA, or others, with polyadenylated mRNA being particularly preferred in some embodiments. As is outlined herein, the target sequence may be a target sequence from a sample, or a secondary target such as an amplicon, which is the product of an amplification reaction such as PCR or RCA. Thus, for example, a target sequence from a sample is amplified to produce an amplicon that is detected. The target sequence may be any length, with the understanding that longer sequences are more specific. As will be appreciated by those in the art, the complementary target sequence may take many forms. For example, it may be contained within a larger nucleic acid sequence, i.e. all or part of a gene or mRNA, a restriction fragment of a plasmid or genomic DNA, among others. Particularly preferred target sequences in the present invention include genomic DNA, polyadenylated mRNA, and alternatively spliced RNAs. As is outlined more fully below, probes are made to hybridize to target sequences to determine the presence, absence, quantity or sequence of a target sequence in a sample. Generally speaking, this term will be understood by those skilled in the art.

[0025] The target sequence may also be comprised of different target domains, that may be adjacent (i.e. contiguous)

or separated. For example, in the OLA techniques outlined below, a first ligation probe may hybridize to a first target domain and a second ligation probe may hybridize to a second target domain; either the domains are directly adjacent, or they may be separated by one or more nucleotides (e.g. indirectly adjacent), coupled with the use of a polymerase and dNTPs, as is more fully outlined below. The terms "first" and "second" are not meant to confer an orientation of the sequences with respect to the 5'-3' orientation of the target sequence. For example, assuming a 5'-3' orientation of the complementary target sequence, the first target domain may be located either 5' to the second domain, or 3' to the second domain. In addition, as will be appreciated by those in the art, the probes on the surface of the array (e.g. attached to the microspheres) may be attached in either orientation, either such that they have a free 3' end or a free 5' end; in some embodiments, the probes can be attached at one or more internal positions, or at both ends.

[0026] If required, the target sequence is prepared using known techniques. For example, the sample may be treated to lyse the cells, using known lysis buffers, sonication, electroporation, etc., with purification and amplification as outlined below occurring as needed, as will be appreciated by those in the art. In addition, the reactions outlined herein may be accomplished in a variety of ways, as will be appreciated by those in the art. Components of the reaction may be added simultaneously, or sequentially, in any order, with preferred embodiments outlined below. In addition, the reaction may include a variety of other reagents which may be included in the assays. These include reagents like salts, buffers, neutral proteins, e.g. albumin, detergents, etc., which may be used to facilitate optimal hybridization and detection, and/or reduce non-specific or background interactions. Also reagents that otherwise improve the efficiency of the assay, such as protease inhibitors, nuclease inhibitors, antimicrobial agents, etc., may be used, depending on the sample preparation methods and purity of the target.

[0027] It should be noted that in some cases, two poly(T) steps are used. In one embodiment, a poly(T) support is used to remove unreacted target probes from the sample. However, a poly(T) support may be used to purify or concentrate poly(A) mRNA from a sample prior to running the assay. For example, total RNA may be isolated from a cell population, and then the poly(A) mRNA isolated from the total RNA and fed into the assay systems described below.

[0028] In addition, in most embodiments, double stranded target nucleic acids are denatured to render them single stranded so as to permit hybridization of the primers and other probes of the invention. A preferred embodiment utilizes a thermal step, generally by raising the temperature of the reaction to about 95°C, although pH changes and other techniques may also be used.

[0029] As outlined herein, the invention makes use of a number of different primers and probes. Probes and primers are designed to have at least a portion be complementary to a target sequence (either the target sequence of the sample or to other probe sequences, such as portions of amplicons, as is described below), such that hybridization of the target sequence and the probes occurs. As outlined below, this complementarity need not be perfect; there may be any number of base pair mismatches which will interfere with hybridization between the target sequence and the single stranded nucleic acids. However, if the number of mutations is so great that no hybridization can occur under even the least stringent of hybridization conditions, the sequence is not a complementary target sequence. Thus, by "substantially complementary" herein is meant that the probes are sufficiently complementary to the target sequences to hybridize under normal reaction conditions, and preferably give the required specificity.

[0030] A variety of hybridization conditions may be used in the present invention, including high, moderate and low stringency conditions; see for example Maniatis et al., *Molecular Cloning: A Laboratory Manual*, 2d Edition, 1989, and *Short Protocols in Molecular Biology*, ed. Ausubel, et al. Stringent conditions are sequence-dependent and will be different in different circumstances. Longer sequences hybridize specifically at higher temperatures. An extensive guide to the hybridization of nucleic acids is found in Tijssen, *Techniques in Biochemistry and Molecular Biology-Hybridization with Nucleic Acid Probes*, "Overview of principles of hybridization and the strategy of nucleic acid assays" (1993). Generally, stringent conditions are selected to be about 5-10°C lower than the thermal melting point (T_m) for the specific sequence at a defined ionic strength and pH. The T_m is the temperature (under defined ionic strength, pH and nucleic acid concentration) at which 50% of the probes complementary to the target hybridize to the target sequence at equilibrium (as the target sequences are present in excess, at T_m , 50% of the probes are occupied at equilibrium). Stringent conditions will be those in which the salt concentration is less than about 1.0 M sodium ion, typically about 0.01 to 1.0 M sodium ion concentration (or other salts) at pH 7.0 to 8.3 and the temperature is at least about 30°C for short probes (e.g. 10 to 50 nucleotides) and at least about 60°C for long probes (e.g. greater than 50 nucleotides). Stringent conditions may also be achieved with the addition of helix destabilizing agents such as formamide. The hybridization conditions may also vary when a non-ionic backbone, i.e. PNA is used, as is known in the art. In addition, cross-linking agents may be added after target binding to cross-link, i.e. covalently attach, the two strands of the hybridization complex.

[0031] Thus, the assays are generally run under stringency conditions which allows formation of the first hybridization complex only in the presence of target. Stringency can be controlled by altering a step parameter that is a thermodynamic variable, including, but not limited to, temperature, formamide concentration, salt concentration, chaotropic salt concentration, pH, organic solvent concentration, etc.

[0032] These parameters may also be used to control non-specific binding, as is generally outlined in U.S. Patent No. 5,681,697. Thus it may be desirable to perform certain steps at higher stringency conditions to reduce non-specific binding.

5 [0033] The size of the primer and probe nucleic acid may vary, as will be appreciated by those in the art with each portion of the probe and the total length of the probe in general varying from 5 to 500 nucleotides in length. Each portion is preferably between 10 and 100 being preferred, between 15 and 50 being particularly preferred, and from 10 to 35 being especially preferred, depending on the use and amplification technique. Thus, for example, the universal priming sites of the probes are each preferably about 15-20 nucleotides in length, with 18 being especially preferred. The adapter sequences of the probes are preferably from 15-25 nucleotides in length, with 20 being especially preferred. The target specific portion of the probe is preferably from 15-50 nucleotides in length.

10 [0034] By "probe set" herein is meant a plurality of target probes that are used in a particular multiplexed assay. In this context, plurality means at least two, with more than 10 being preferred, depending on the assay, sample and purpose of the test.

15 [0035] Accordingly, first target probe sets that comprise universal priming sites are described. By "universal priming site" herein is meant a sequence of the probe that will bind a PCR primer for amplification. Each probe comprises an upstream universal priming site (UUP) or a downstream universal priming site (DUP). Again, "upstream" and "downstream" are not meant to convey a particular 5'-3' orientation, and will depend on the orientation of the system. Preferably, only a single UUP sequence and a single DUP sequence is used in a probe set, although as will be appreciated by those in the art, different assays or different multiplexing analysis may utilize a plurality of universal priming sequences. In addition, the universal priming sites are preferably located at the 5' and 3' termini of the target probe (or the ligated probe), as only sequences flanked by priming sequences will be amplified.

20 [0036] In addition, universal priming sequences are generally chosen to be as unique as possible given the particular assays and host genomes to ensure specificity of the assay. In general, universal priming sequences range in size from about 5 to about 25 basepairs, with from about 10 to about 20 being particularly preferred.

25 [0037] As will be appreciated by those in the art, the orientation of the two priming sites is different. That is, one PCR primer will directly hybridize to the first priming site, while the other PCR primer will hybridize to the complement of the second priming site. Stated differently, the first priming site is in sense orientation, and the second priming site is in antisense orientation.

[0038] In addition to the universal priming sites, the target probes comprise at least a first target-specific ' sequence, that is substantially complementary to the target sequence. As outlined below, ligation probes each comprise a target-specific sequence. As will be appreciated by those in the art, the target-specific sequence comprises a portion that will hybridize to all or part of the target sequence and includes one or more particular single nucleotide polymorphisms (SNPs).

30 [0039] The invention is directed to target sequences that comprise one or more positions for which sequence information is desired, generally referred to herein as the "detection position" or "detection locus". In a preferred embodiment, the detection position is a single nucleotide (sometimes referred to as a single nucleotide polymorphism (SNP)), although in some embodiments, it may comprise a plurality of nucleotides, either contiguous with each other or separated by one or more nucleotides. By "plurality" as used herein is meant at least two. As used herein, the base of a probe (e.g. the target probe) which basepairs with a detection position base in a hybrid is termed a "readout position" or an "interrogation position". Thus, the target sequence comprises a detection position and the target probe comprises a readout position. In general, this embodiment utilizes the OLA or RCA assay, as described below.

35 [0040] Also described herein is the use of competitive hybridizations target probes to elucidate either the identity of the nucleotide(s) at the detection position or the presence of a mismatch.

40 [0041] It should be noted in this context that "mismatch" is a relative term and meant to indicate a difference in the identity of a base at a particular position, termed the "detection position" herein, between two sequences. In general, sequences that differ from wild type sequences are referred to as mismatches. However, particularly in the case of SNPs, what constitutes "wild type" may be difficult to determine as multiple alleles can be relatively frequently observed in the population, and thus "mismatch" in this context requires the artificial adoption of one sequence as a standard. Thus, for the purposes of this invention, sequences are referred to herein as "match" and "mismatch". Thus, the present invention may be used to detect substitutions, insertions or deletions as compared to a wild-type sequence. That is, all other parameters being equal, a perfectly complementary readout target probe (a "match probe") will in general be more stable and have a slower off rate than a target probe comprising a mismatch (a "mismatch probe") at any particular temperature.

45 [0042] In a method described herein for reference, only a single probe is used, comprising (as outlined herein), a UUP, an adapter sequence, a target-specific sequence comprising a first base at the readout position, and a DUP. This probe is contacted with the target sequence under conditions (whether thermal or otherwise) such that a hybridization complex is formed only when a perfect match between the detection position of the target and the readout position of the probe is present. The non-hybridized probes are then removed as outlined herein, and the hybridization complex is denatured. The probe is then amplified as outlined herein, and detected on an array.

50 [0043] A plurality of target probes (sometimes referred to herein as "readout target probes") may be used to identify the base at the detection position. Here, each different readout probe comprises a different base at the position that will hybridize to the detection position of the target sequence (herein referred to as the readout or interrogation position)

and a different adapter sequence for each different readout position. In this way, differential hybridization of the readout target probes, depending on the sequence of the target, results in identification of the base at the detection position. Here, the readout probes are contacted with the array again under conditions that allow discrimination between match and mismatch, and the unhybridized probes are removed, etc.

5 [0044] Accordingly, by using different readout target probes, each with a different base at the readout position and each with a different adapter, the identification of the base at the detection position is elucidated. Thus, a set of readout probes may be used, each comprising a different base at the readout position.

10 [0045] Each readout target probe may have a different adapter sequence. That is, readout target probes comprising adenine at the readout position will have a first adapter, probes with guanine at the readout position will have a second adapter, etc., such that each target probe that hybridizes to the target sequence will bind to a different address on the array. This can allow the use of the same label for each reaction.

[0046] The number of readout target probes used will vary depending on the end use of the assay. For example, many SNPs are biallelic, and thus two readout target probes, each comprising an interrogation base that will basepair with one of the detection position bases. For sequencing, for example, for the discovery of SNPs, a set of four readout probes are used.

15 [0047] Sensitivity to variations in stringency parameters may be used to determine either the identity of the nucleotide (s) at the detection position or the presence of a mismatch. As a preliminary matter, the use of different stringency conditions such as variations in temperature and buffer composition to determine the presence or absence of mismatches in double stranded hybrids comprising a single stranded target sequence and a probe is well known.

20 [0048] With particular regard to temperature, as is known in the art, differences in the number of hydrogen bonds as a function of basepairing between perfect matches and mismatches can be exploited as a result of their different T_m s (the temperature at which 50% of the hybrid is denatured). Accordingly, a hybrid comprising perfect complementarity will melt at a higher temperature than one comprising at least one mismatch, all other parameters being equal. (It should be noted that for the purposes of the discussion herein, all other parameters (i.e. length of the hybrid, nature of the backbone (i.e. naturally occurring or nucleic acid analog), the assay solution composition and the composition of the bases, including G-C content are kept constant). However, as will be appreciated by those in the art, these factors may be varied as well, and then taken into account.)

25 [0049] In general, as outlined herein, high stringency conditions are those that result in perfect matches remaining in hybridization complexes, while imperfect matches melt off. Similarly, low stringency conditions are those that allow the formation of hybridization complexes with both perfect and imperfect matches. High stringency conditions are known in the art see for example Maniatis et al., *Molecular Cloning: A Laboratory Manual*, 2d Edition, 1989, and *Short Protocols in Molecular Biology*, ed. Ausubel, et al., both of which are hereby incorporated by reference. Stringent conditions are sequence-dependent and will be different in different circumstances. Longer sequences hybridize specifically at higher temperatures. An extensive guide to the hybridization of nucleic acids is found in Tijssen, *Techniques in Biochemistry and Molecular Biology-Hybridization with Nucleic Acid Probes*, "Overview of principles of hybridization and the strategy of nucleic acid assays" (1993). Generally, stringent conditions are selected to be about 5-10°C lower than the thermal melting point (T_m) for the specific sequence at a defined ionic strength pH. The T_m is the temperature (under defined ionic strength, pH and nucleic acid concentration) at which 50% of the probes complementary to the target hybridize to the target sequence at equilibrium (as the target sequences are present in excess, at T_m , 50% of the probes are occupied at equilibrium). Stringent conditions will be those in which the salt concentration is less than about 1.0 M sodium ion, typically about 0.01 to 1.0 M sodium ion concentration (or other salts) at pH 7.0 to 8.3 and the temperature is at least about 30°C for short probes (e.g. 10 to 50 nucleotides) and at least about 60°C for long probes (e.g. greater than 50 nucleotides). Stringent conditions may also be achieved with the addition of destabilizing agents such as formamide. In another embodiment, less stringent hybridization conditions are used; for example, moderate or low stringency conditions may be used, as are known in the art; see Maniatis and Ausubel, *supra*, and Tijssen, *supra*.

45 [0050] As will be appreciated by those in the art, mismatch detection using temperature may proceed in a variety of ways.

[0051] Similarly, variations in buffer composition may be used to elucidate the presence or absence of a mismatch at the detection position. Suitable conditions include, but are not limited to, formamide concentration. Thus, for example, "low" or "permissive" stringency conditions include formamide concentrations of 0 to 10%, while "high" or "stringent" conditions utilize formamide concentrations of $\geq 40\%$. Low stringency conditions include NaCl concentrations of ≥ 1 M, and high stringency conditions include concentrations of ≤ 0.3 M. Furthermore, low stringency conditions include MgCl₂ concentrations of 10 mM, moderate stringency as 1-10 mM, and high stringency conditions include concentrations of ≤ 1 mM.

50 [0052] Here, as for temperature, a plurality of readout probes may be used, with different bases in the readout position and different adapters. Running the assays under the permissive conditions and repeating under stringent conditions will allow the elucidation of the base at the detection position.

[0053] In methods of the present invention, two target probes are used to allow the use of OLA (or RCA) assay systems and specificity. This finds particular use in genotyping reactions, for the identification of nucleotides at a detection position

as outlined herein.

[0054] The basic OLA method can be run at least two different ways; in a first embodiment, only one strand of a target sequence is used as a template for ligation; alternatively, both strands may be used; the latter is generally referred to as Ligation Chain Reaction or LCR. See generally U.S. Patent Nos. 5,185,243 and 5,573,907; EP 0 320 308 B1; EP 0 336 731 B1; EP 0 439 182 B1; WO 90/01069; WO 89/12696; and WO 89/09835. The discussion below focuses on OLA, but as those in the art will appreciate, this can easily be applied to LCR as well.

[0055] The target probes comprise at least a first ligation probe and a second ligation probe. The method is based on the fact that two probes can be preferentially ligated together, if they are hybridized to a target strand and if perfect complementarity exists between the two interrogation bases being ligated together and the corresponding detection positions on the target strand. Thus, the target sequence comprises a contiguous first target domain comprising the detection position and a second target domain adjacent to the detection position. That is, the detection position is "between" the rest of the first target domain and the second target domain. Again, the orientation of the probes is not determinative; the detection position may be at the "end" of the first ligation probe or at the "beginning" of the second.

[0056] A first ligation probe is hybridized to the first target domain and a second ligation probe is hybridized to the second target domain. If the first ligation probe has a base perfectly complementary to the detection position base, and the adjacent base on the second probe has perfect complementarity to its position, a ligation structure is formed such that the two probes can be ligated together to form a ligated probe. If this complementarity does not exist, no ligation structure is formed and the probes are not ligated together to an appreciable degree. This may be done using heat cycling, to allow the ligated probe to be denatured off the target sequence such that it may serve as a template for further reactions. In addition, as is more fully outlined below, this method may also be done using three ligation probes or ligation probes that are separated by one or more nucleotides, if dNTPs and a polymerase are added (this is sometimes referred to as "Genetic Bit" analysis).

[0057] In a preferred embodiment, LCR is done for two strands of a double-stranded target sequence. The target sequence is denatured, and two sets of probes are added: one set as outlined above for one strand of the target, and a separate set (i.e. third and fourth ligation target probe nucleic acids) for the other strand of the target. In this embodiment, a preferred method utilizes each set of probes with a different adapter; this may have particular use to serve as an additional specificity control; that is, only if both strands are seen is a "positive" called.

[0058] Again, as outlined herein, the target-specific sequence of the ligation probes can be designed to be substantially complementary to a variety of targets.

[0059] In general, each target specific sequence of a ligation probe is at least about 5 nucleotides long, with sequences of at from about 8 to 15 being preferred and 10 being especially preferred.

[0060] In a preferred embodiment, three or more ligation probes are used. This general idea is depicted in Figure 6. In this embodiment, there is an intervening ligation probe, specific to a third domain of the target sequence, that is used. Again, this may be done to detect SNPs, if desired.

[0061] In a preferred embodiment, the two ligation target probes are not directly adjacent. In this embodiment, they may be separated by one or more bases. The addition of dNTPs and a polymerase, as outlined below for the amplification reactions, followed by the ligation reaction, allows the formation of the ligated probe.

[0062] In addition to the universal priming sites and the target specific sequence(s), the target probes used in the invention further comprise one or more adapter sequences. An "adapter sequence" is a sequence, generally exogenous to the target sequences, e.g. artificial, that is designed to be substantially complementary (and preferably perfectly complementary) to a capture probe on the array. The use of adapter sequences allow the creation of more "universal" surfaces; that is, one standard array, comprising a finite set of capture probes can be made and used in any application. The end-user can customize the array by designing different soluble target probes, which, as will be appreciated by those in the art, is generally simpler and less costly. In a preferred embodiment, an array of different and usually artificial capture probes are used, that is, the capture probes do not have complementarity to known target sequences. The adapter sequences can then be incorporated in the target probes.

[0063] As will be appreciated by those in the art, the length of the adapter sequences will vary, depending on the desired "strength" of binding and the number of different adapters desired. In a preferred embodiment, adapter sequences range from about 6 to about 500 basepairs in length, with from about 8 to about 100 being preferred, and from about 10 to about 25 being particularly preferred, are used.

[0064] As will be appreciated by those in the art, the placement and orientation of the adapter sequences can vary widely, depending on the configuration of the assay and the assay itself. For example, in most of the OLA embodiments depicted herein, the adapter sequences are shown on the "upstream" ligation probe; however, the downstream probe can also be used; what is important is that at least one of the ligation probes comprise an adapter sequence. Basically, as will be appreciated by those in the art, the different components of the target probes can be placed in any order, just as long as the universal priming sites remain on the outermost ends of the probe, to allow all sequences between them to be amplified. In general the adapter sequences will have similar hybridization characteristics, e.g. similar melting temperatures, similar (G+C) content.

[0065] In a preferred embodiment, two adapter sequences per ligated target probe are used. That is, as is generally depicted in Figure 6, each ligation probe can comprise a different adapter sequence. The ligated probe will then hybridize to two different addresses on the array; this provides a level of quality control and specificity. In addition, it is also possible to use two adapter sequences for single target probes, if desired.

5 [0066] In a preferred embodiment, the target probe may also comprise a label sequence, i.e. a sequence that can be used to bind label probes and is substantially complementary to a label probe. This is sometimes referred to in the art as "sandwich-type" assays. That is, by incorporating a label sequence into the target probe, which is then amplified and present in the amplicons, a label probe comprising primary (or secondary) labels can be added to the mixture, either before addition to the array or after. This allows the use of high concentrations of label probes for efficient hybridization. 10 In one embodiment, it is possible to use the same label sequence and label probe for all target probes on an array; alternatively, different target probes can have a different label sequence. Similarly, the use of different label sequences can facilitate quality control; for example, one label sequence (and one color) can be used for one strand of the target, and a different label sequence (with a different color) for the other, only if both colors are present at the same basic level is a positive called.

15 [0067] Thus, the present invention uses target probes that comprise universal priming sequences, target specific sequence(s), adapter sequences and optionally label sequences. These target probes are then added to the target sequences to form hybridization complexes. As will be appreciated by those in the art, the hybridization complexes contain portions that are double stranded (the target-specific sequences of the target probes hybridized to a portion of the target sequence) and portions that are single stranded (the ends of the target probes comprising the universal priming sequences and the adapter sequences, and any unhybridized portion of the target sequence, such as poly(A) tails, as outlined herein). 20

[0068] Once the hybridization complexes are formed, unhybridized probes are removed. This is important as all target probes may form some unpredictable structures that will complicate the amplification using the universal priming sequences. Thus to ensure specificity (e.g. that target probes directed to target sequences that are not present in the sample are not amplified and detected), it is important to remove all the nonhybridized probes. As will be appreciated by those in the art, this may be done in a variety of ways, including methods based on the target sequence, methods utilizing double stranded specific moieties, and methods based on probe design and content. In methods of the invention, target nucleic acid is provided immobilized on a solid support. 25

[0069] In a preferred embodiment, target specific methods are utilized. That is, any property common to all the targets in a sample can be utilized. For example, when the target sequences comprise poly(A) tails, such as mRNAs, separation of unhybridized target probes is done utilizing supports comprising poly(T) sequences. Poly(A) tails may also be added to targets by polymerization with terminal transferase, or via ligation of an oligoA linker, as is known in the art. 30

[0070] Thus, for example, supports (as defined below), particularly magnetic beads, comprising poly(T) sequences are added to the mixture comprising the target sequences and the target probes. In this embodiment, the first hybridization complexes comprise a single-stranded portion comprising a poly(A) sequence, generally ranging from 10 to 100s adenosines. The first hybridization complexes form a second hybridization complex, as outlined in Figure 7. The poly(T) support is then used to separate the unhybridized target probes from the hybridization complexes. For example, when magnetic beads are used, they may be removed from the mixture and washed; non-magnetic beads may be removed via centrifugation and washed, etc. The hybridization complexes are then released (and denatured) from the beads using a denaturation step such as a thermal step. 35 40

[0071] In a preferred embodiment, methods relying on the addition of binding ligands to the target sequences are done. In this embodiment, enzymes are used to add binding partners that can be used to separate out the hybridization complexes from the unhybridized probes. For example, using terminal transferase enzymes, dNTPs that include a binding ligand such as biotin (or others outlined herein for secondary labels) are added to a terminus of the target sequence(s). The binding partner of the binding ligand can then be ultimately used to separate or remove the unhybridized probes. 45

[0072] As will be appreciated by those in the art, this can be accomplished in a variety of ways. In this embodiment, the binding ligand is added to the target sequence prior to the formation of the hybridization complex.

[0073] A preferred embodiment utilizes terminal transferase and dideoxynucleotides labeled with biotin, although as will be appreciated by those in the art, the binding ligand need not be attached to a chain-terminating nucleotide. 50

[0074] Once added, the target sequence is immobilized before the formation of the hybridization complex. In a preferred embodiment, the target sequence is immobilized on a surface or support comprising the binding partner of the binding ligand prior to the formation of the hybridization complex with the probe(s) of the invention. For example, a preferred embodiment utilizes binding partner coated reaction vessels such as eppendorf tubes or microtiter wells. Alternatively, the support may be in the form of beads, including magnetic beads. In this embodiment, the target sequences are immobilized, the target probes are added to form hybridization complexes. Unhybridized probes are then removed through washing steps, and the bound probes (e.g. either target probes, ligated probes, or ligated RCA probes) are then eluted off the support, usually through the use of elevated temperature or buffer conditions (pH, salt, etc.). 55

[0075] In this embodiment, particularly preferred binding ligand/binding partner pairs are biotin and streptavidin or avidin, antigens and antibodies; other chemical ways are described herein.

5 [0076] In the case where the OLA reaction is done, an additional embodiment, depicted in Figure 8, may be done to remove unhybridized primers. In this embodiment, a nuclease inhibitor is added to the 3' end of the downstream ligation probe, which does not comprise the adapter sequence. Thus, any nucleic acids that do not contain the inhibitors (including both the 5' unligated probe and the target sequences themselves) will be digested upon addition of a 3'-exonuclease. The ligation products are protected from *exo I* digestion by including, for example, 4-phosphorothioate residues at their 3' terminus, thereby, rendering them resistant to exonuclease digestion. The unligated detection oligonucleotides are not protected and are digested. Since the 5' upstream ligation probe carries the adapter sequence, the unligated downstream probe, which does carry the nuclease inhibitor and is thus also not digested, does not bind to the array and can be washed away.

10 [0077] Suitable nuclease inhibitors are known in the art and comprise thiol nucleotides. In this embodiment, suitable 3'-exonucleases include, but are not limited to, *exo I*, *exo III*, *exo VII*, and 3'-5' exophosphodiesterases.

15 [0078] Once the non-hybridized probes (and additionally, if preferred, other sequences from the sample that are not of interest) are removed, the hybridization complexes are denatured and the target probes are amplified to form amplicons, which are then detected. This can be done in one of several ways, including PCR amplification and rolling circle amplification. In addition, as outlined below, labels can be incorporated into the amplicons in a variety of ways.

20 [0079] In a preferred embodiment, the target amplification technique is PCR. The polymerase chain reaction (PCR) is widely used and described, and involves the use of primer extension combined with thermal cycling to amplify a target sequence; see U.S. Patent Nos. 4,683,195 and 4,683,202, and PCR Essential Data, J. W. Wiley & sons, Ed. C.R. Newton, 1995.

25 [0080] In general, PCR may be briefly described as follows. The double stranded hybridization complex is denatured, generally by raising the temperature, and then cooled in the presence of an excess of a PCR primer, which then hybridizes to the first universal priming site. A DNA polymerase then acts to extend the primer with dNTPs, resulting in the synthesis of a new strand forming a hybridization complex. The sample is then heated again, to disassociate the hybridization complex, and the process is repeated. By using a second PCR primer for the complementary target strand that hybridizes to the second universal priming site, rapid and exponential amplification occurs. Thus PCR steps are denaturation, annealing and extension. The particulars of PCR are well known, and include the use of a thermostable polymerase such as *Taq I* polymerase and thermal cycling. Suitable DNA polymerases include, but are not limited to, the Klenow fragment of DNA polymerase I, SEQUENASE 1.0 and SEQUENASE 2.0 (U.S. Biochemical), T5 DNA polymerase and Phi29 DNA polymerase.

30 [0081] The reaction is initiated by introducing the target probe comprising the target sequence to a solution comprising the universal primers, a polymerase and a set of nucleotides. By "nucleotide" in this context herein is meant a deoxy-nucleoside-triphosphate (also called deoxynucleotides or dNTPs, e.g. dATP, dTTP, dCTP and dGTP). In some embodiments, as outlined below, one or more of the nucleotides may comprise a detectable label, which may be either a primary or a secondary label. In addition, the nucleotides may be nucleotide analogs, depending on the configuration of the system. Similarly, the primers may comprise a primary or secondary label.

35 [0082] Accordingly, the PCR reaction requires at least one PCR primer, a polymerase, and a set of dNTPs. As outlined herein, the primers may comprise the label, or one or more of the dNTPs may comprise a label.

40 [0083] In a preferred embodiment, the methods of the invention include a rolling circle amplification (RCA) step. In one embodiment, ligated probes can be used in the genotyping part of the assay, followed by RCA instead of PCR.

45 [0084] In a preferred embodiment, the methods rely on rolling circle amplification. "Rolling circle amplification." is based on extension of a circular probe that has hybridized to a target sequence. A polymerase is added that extends the probe sequence. As the circular probe has no terminus, the polymerase repeatedly extends the circular probe resulting in concatamers of the circular probe. As such, the probe is amplified. Rolling-circle amplification is generally described in Baner et al. (1998) *Nuc. Acids Res.* 26:5073-5078; Barany, F. (1991) *Proc. Natl. Acad. Sci. USA* 88:189-193; and Lizardi et al. (1998) *Nat. Genet.* 19:225-232.

50 [0085] In general, RCA may be described in two ways, as generally depicted in Figures 9 and 10. First, as is outlined in more detail below, a single target probe is hybridized with a target nucleic acid. Each terminus of the probe hybridizes adjacently on the target nucleic acid and the OLA assay as described above occurs. When ligated, the probe is circularized while hybridized to the target nucleic acid. Addition of a polymerase results in extension of the circular probe. However, since the probe has no terminus, the polymerase continues to extend the probe repeatedly. Thus results in amplification of the circular probe.

55 [0086] A second alternative approach involves a two step process. In this embodiment, which is an embodiment according to the invention, two ligation probes are initially ligated together, each containing a universal priming sequence. A rolling circle primer is then added, which has portions that will hybridize to the universal priming sequences. The presence of the ligase then causes the original probe to circularize, using the rolling circle primer as the polymerase primer, which is then amplified as above.

[0087] These methods described also have the advantage that unligated probes need not necessarily be removed, as in the absence of the target, no significant amplification will occur. These benefits may be maximized by the design of the probes; for example, in the first embodiment, when there is a single target probe, placing the universal priming site close to the 5' end of the probe since this will only serve to generate short, truncated pieces, without adapters, in the absence of the ligation reaction.

[0088] Described herein for reference is a version of RCA in which a single oligonucleotide is used both for OLA and as the circular template for RCA (referred to herein as a "padlock probe" or a "RCA probe"). That is, each terminus of the oligonucleotide contains sequence complementary to the target nucleic acid and functions as an OLA primer as described above. That is, the first end of the RCA probe is substantially complementary to a first target domain, and the second end of the RCA probe is substantially complementary to a second target domain, adjacent to the first domain. Hybridization of the oligonucleotide to the target nucleic acid results in the formation of a hybridization complex. Ligation of the "primers" (which are the discrete ends of a single oligonucleotide) results in the formation of a modified hybridization complex containing a circular probe i.e. an RCA template complex. That is, the oligonucleotide is circularized while still hybridized with the target nucleic acid. This serves as a circular template for RCA. Addition of a primer and a polymerase to the RCA template complex results in the formation of an amplicon.

[0089] Labeling of the amplicon can be accomplished in a variety of ways; for example, the polymerase may incorporate labeled nucleotides, or alternatively, a label probe is used that is substantially complementary to a portion of the RCA probe and comprises at least one label is used, as is generally outlined herein.

[0090] The polymerase can be any polymerase, but is preferably one lacking 3' exonuclease activity (3' exo-). Examples of suitable polymerase include but are not limited to exonuclease minus DNA Polymerase I large (Klenow) Fragment, Phi29 DNA polymerase, Taq DNA Polymerase and the like. In addition, in some embodiments, a polymerase that will replicate single-stranded DNA (i.e. without a primer forming a double stranded section) can be used.

[0091] The RCA probe may contain an adapter sequence as outlined herein, with adapter capture probes on the array, for example on a microsphere when microsphere arrays are being used. Alternatively, unique portions of the RCA probes, for example all or part of the sequence corresponding to the target sequence, can be used to bind to a capture probe.

[0092] The padlock probe may contain a restriction site. The restriction endonuclease site allows for cleavage of the long concatamers that are typically the result of RCA into smaller individual units that hybridize either more efficiently or faster to surface bound capture probes. Thus, following RCA, the product nucleic acid is contacted with the appropriate restriction endonuclease. This results in cleavage of the product nucleic acid into smaller fragments. The fragments are then hybridized with the capture probe that is immobilized resulting in a concentration of product fragments onto the microsphere. Again, as outlined herein, these fragments can be detected in one of two ways: either labelled nucleotides are incorporated during the replication step, or an additional label probe is added.

[0093] Thus, the padlock probe may comprise a label sequence; i.e. a sequence that can be used to bind label probes and is substantially complementary to a label probe. It is possible to use the same label sequence and label probe for all padlock probes on an array; alternatively, each padlock probe can have a different label sequence.

[0094] The padlock probe also contains a priming site for priming the RCA reaction. That is, each padlock probe comprises a sequence to which a primer nucleic acid hybridizes forming a template for the polymerase. The primer can be found in any portion of the circular probe.

[0095] The primer may be located at a discrete site in the probe. The primer site in each distinct padlock probe may be identical, e.g. is a universal priming site, although this is not required. Advantages of using primer sites with identical sequences include the ability to use only a single primer oligonucleotide to prime the RCA assay with a plurality of different hybridization complexes. That is, the padlock probe hybridizes uniquely to the target nucleic acid to which it is designed. A single primer hybridizes to all of the unique hybridization complexes forming a priming site for the polymerase. RCA then proceeds from an identical locus within each unique padlock probe of the hybridization complexes.

[0096] Alternatively, the primer site can overlap, encompass, or reside within any of the above-described elements of the padlock probe. That is, the primer can be found, for example, overlapping or within the restriction site or the identifier sequence. Here, it is necessary that the primer nucleic acid is designed to base pair with the chosen primer site.

[0097] Thus, the padlock probe contains at each terminus, sequences corresponding to OLA primers. The intervening sequence of the padlock probe contain in no particular order, an adapter sequence and a restriction endonuclease site. In addition, the padlock probe contains a RCA priming site.

[0098] Thus, the OLA/RCA is performed in solution followed by restriction endonuclease cleavage of the RCA product. The cleaved product is then applied to an array comprising beads, each bead comprising a probe complementary to the adapter sequence located in the padlock probe. The amplified adapter sequence correlates with a particular target nucleic acid. Thus the incorporation of an endonuclease site allows the generation of short, easily hybridizable sequences. Furthermore, the unique adapter sequence in each rolling circle padlock probe sequence allows diverse sets of nucleic acid sequences to be analyzed in parallel on an array, since each sequence is resolved on the basis of hybridization specificity.

[0099] Thus, the present invention provides for the generation of amplicons (sometimes referred to herein as secondary

targets).

[0100] In a preferred embodiment, the amplicons are labeled with a detection label. By "detection label" or "detectable label" herein is meant a moiety that allows detection. This may be a primary label or a secondary label. Accordingly, detection labels may be primary labels (i.e. directly detectable) or secondary labels (indirectly detectable).

[0101] In a preferred embodiment, the detection label is a primary label. A primary label is one that can be directly detected, such as a fluorophore. In general, labels fall into three classes: a) isotopic labels, which may be radioactive or heavy isotopes; b) magnetic, electrical, thermal labels; and c) colored or luminescent dyes. Labels can also include enzymes (horseradish peroxidase, etc.) and magnetic particles. Preferred labels include chromophores or phosphors but are preferably fluorescent dyes. Suitable dyes for use in the invention include, but are not limited to, fluorescent lanthanide complexes, including those of Europium and Terbium, fluorescein, rhodamine, tetramethylrhodamine, eosin, erythrosin, coumarin, methyl-coumarins, quantum dots (also referred to as "nanocrystals": see U.S.S.N. 09/315,584, hereby incorporated by reference), pyrene, Malacite green, stilbene, Lucifer Yellow, Cascade Blue™, Texas Red, Cy dyes (Cy3, Cy5, etc.), alexa dyes, phycoerythrin, bodipy, and others described in the 6th Edition of the Molecular Probes Handbook by Richard P. Haugland.

[0102] In a preferred embodiment, a secondary detectable label is used. A secondary label is one that is indirectly detected; for example, a secondary label can bind or react with a primary label for detection, can act on an additional product to generate a primary label (e.g. enzymes), or may allow the separation of the compound comprising the secondary label from unlabeled materials, etc. Secondary labels include, but are not limited to, one of a binding partner pair such as biotin/streptavidin; chemically modifiable moieties; nuclease inhibitors, enzymes such as horseradish peroxidase, alkaline phosphatases, luciferases, etc.

[0103] In a preferred embodiment, the secondary label is a binding partner pair. For example, the label may be a hapten or antigen, which will bind its binding partner. In a preferred embodiment, the binding partner can be attached to a solid support to allow separation of extended and non-extended primers. For example, suitable binding partner pairs include, but are not limited to: antigens (such as proteins (including peptides)) and antibodies (including fragments thereof (FABs, etc.)); proteins and small molecules, including biotin/streptavidin; enzymes and substrates or inhibitors; other protein-protein interacting pairs; receptor-ligands; and carbohydrates and their binding partners. Nucleic acid - nucleic acid binding proteins pairs are also useful. In general, the smaller of the pair is attached to the NTP for incorporation into the primer. Preferred binding partner pairs include, but are not limited to, biotin (or imino-biotin) and streptavidin, digeoxinin and Abs, and Prolinx™ reagents (see www.prolinxinc.com/ie4/home.html).

[0104] In a preferred embodiment, the binding partner pair comprises biotin or imino-biotin and streptavidin. Imino-biotin is particularly preferred as imino-biotin disassociates from streptavidin in pH 4.0 buffer while biotin requires harsh denaturants (e.g. 6 M guanidinium HCl, pH 1.5 or 90% formamide at 95°C).

[0105] In a preferred embodiment, the binding partner pair comprises a primary detection label (for example, attached to the NTP and therefore to the amplicon) and an antibody that will specifically bind to the primary detection label. By "specifically bind" herein is meant that the partners bind with specificity sufficient to differentiate between the pair and other components or contaminants of the system. The binding should be sufficient to remain bound under the conditions of the assay, including wash steps to remove non-specific binding. In some embodiments, the dissociation constants of the pair will be less than about 10^{-4} - 10^{-6} M⁻¹, with less than about 10^{-5} to 10^{-9} M⁻¹ being preferred and less than about 10^{-7} - 10^{-9} M⁻¹ being particularly preferred.

[0106] In a preferred embodiment, the secondary label is a chemically modifiable moiety. In this embodiment, labels comprising reactive functional groups are incorporated into the nucleic acid. The functional group can then be subsequently labeled with a primary label. Suitable functional groups include, but are not limited to, amino groups, carboxy groups, maleimide groups, oxo groups and thiol groups, with amino groups and thiol groups being particularly preferred. For example, primary labels containing amino groups can be attached to secondary labels comprising amino groups, for example using linkers as are known in the art; for example, homo-or hetero-bifunctional linkers as are well known (see 1994 Pierce Chemical Company catalog, technical section on cross-linkers, pages 155-200).

[0107] As outlined herein, labeling can occur in a variety of ways, as will be appreciated by those in the art. In general, labeling can occur in one of three ways: labels are incorporated into primers such that the amplification reaction results in amplicons that comprise the labels; labels are attached to dNTPs and incorporated by the polymerase into the amplicons; or the amplicons comprise a label sequence that is used to hybridize a label probe, and the label probe comprises the labels. It should be noted that in the latter case, the label probe can be added either before the amplicons are contacted with an array or afterwards.

[0108] A preferred embodiment utilizes one primer comprising a biotin, that is used to bind a fluorescently labeled streptavidin.

[0109] In addition to the methods outlined herein, the present invention also provides methods for accomplishing genotyping of genomic DNA. In general, this method can be described as follows, as is generally described in WO 00/63437. Genomic DNA is prepared from sample cells (and generally cut into smaller segments, for example through shearing or enzymatic treatment with enzymes such as DNAse I, as is well known in the art). Using any number of

techniques, as are outlined below, the genomic fragments are attached, either covalently or securely, to a support such as beads or reaction wells (eppendorf tubes, microtiter wells, etc.). Any number of different genotyping reactions can then be done as outlined below, and the reaction products from these genotyping reactions are released from the support, amplified as necessary and added to an array of capture probes as outlined herein. In general, the methods described
5 herein relate to the detection of nucleotide substitutions, although as will be appreciated by those in the art, deletions, insertions, inversions, etc. may also be detected. Universal primers can also be included as necessary.

[0110] These genotyping techniques fall into five general categories: (1) techniques that rely on traditional hybridization methods that utilize the variation of stringency conditions (temperature, buffer conditions, etc.) to distinguish nucleotides at the detection position; (2) extension techniques that add a base ("the base") to basepair with the nucleotide at the
10 detection position; (3) ligation techniques, that rely on the specificity of ligase enzymes (or, in some cases, on the specificity of chemical techniques), such that ligation reactions occur preferentially if perfect complementarity exists at the detection position; (4) cleavage techniques, that also rely on enzymatic or chemical specificity such that cleavage occurs preferentially if perfect complementarity exists; and (5) techniques that combine these methods. Reactions according to the present invention are as defined in the claims.

[0111] As above, if required, the target genomic sequence is prepared using known techniques, and then attached to a solid support as defined herein. These techniques include, but are not limited to, enzymatic attachment, chemical attachment, photochemistry or thermal attachment and absorption.

[0112] In a preferred embodiment, as outlined herein, enzymatic techniques are used to attach the genomic DNA to the support. For example, terminal transferase end-labeling techniques can be used as outlined above; see Hermanson, Bioconjugate Techniques, San Diego, Academic Press, pp 640-643). In this embodiment, a nucleotide labeled with a secondary label (e.g. a binding ligand) is added to a terminus of the genomic DNA; supports coated or containing the binding partner can thus be used to immobilize the genomic DNA. Alternatively, the terminal transferase can be used to add nucleotides with special chemical functionalities that can be specifically coupled to a support. Similarly, random-primed labeling or nick-translation labeling (supra, pp. 640-643) can also be used.

[0113] In a preferred embodiment, chemical labeling (supra, pp.6444-671) can be used. In this embodiment, bisulfite-catalyzed transamination, sulfonation of cytosine residues, bromine activation of T, C and G bases, periodate oxidation of RNA or carbodiimide activation of 5' phosphates can be done.

[0114] In a preferred embodiment, photochemistry or heat-activated labeling is done (supra, p162-166). Thus for example, aryl azides and nitrenes preferably label adenosines, and to a less extent C and T (Aslam et al., Bioconjugation: Protein Coupling Techniques for Biomedical Sciences; New York, Grove's Dictionaries, 833 pp.). Psoralen or angelicin compounds can also be used (Aslam, p492, supra). The preferential modification of guanine can be accomplished via intercalation of platinum complexes (Aslam, supra).

[0115] In a preferred embodiment, the genomic DNA can be absorbed on positively charged surfaces, such as an amine coated solid phase. The genomic DNA can be cross-linked to the surface after physical absorption for increased retention (e.g. PEI coating and glutaraldehyde cross-linking; Aslam, supra, p.485).

[0116] In a preferred embodiment, direct chemical attached or photocrosslinking can be done to attach the genomic DNA to the solid phase, by using direct chemical groups on the solid phase substrate. For example, carbodiimide activation of 5' phosphates, attachment to exocyclic amines on DNA bases, and psoralen can be attached to the solid phase for crosslinking to the DNA.

[0117] Once added to the support, the target genomic sequence can be used in a variety of reactions for a variety of reasons. For example, in a preferred embodiment, genotyping reactions are done. Similarly, these reactions can also be used to detect the presence or absence of a target genomic sequence. In addition, in any reaction, quantitation of the amount of a target genomic sequence may be done. While the discussion below focuses on genotyping reactions, the discussion applies equally to detecting the presence of target sequences and/or their quantification.

[0118] As will be appreciated by those in the art, the reactions described below can take on a wide variety of formats. In one embodiment, genomic DNA is attached to a solid support, and probes comprising universal primers are added to form hybridization complexes, in a variety of formats as outlined herein. The non-hybridized probes are then removed, and the hybridization complexes are denatured. This releases the probes (which frequently have been altered in some way). They are then amplified and added to an array of capture probes. In a preferred embodiment, non-hybridized primers are removed prior to the enzymatic step. Several embodiments of this have been described above. Alternatively, genomic DNA is attached to a solid support, and genotyping reactions are done in formats that can allow amplification as well, either during the genotyping reaction (e.g. through the use of heat cycling) or after, without the use of universal primers. Thus, for example, when labeled probes are used, they can be hybridized to the immobilized genomic DNA, unbound materials removed, and then eluted and collected to be added to arrays. This may be repeated for amplification purposes, with the elution fractions pooled and added to the array. In addition, alternative amplification schemes such as extending a product of the invasive cleavage reaction (described below) to include universal primers or universal primers and adapters can be performed. In one embodiment this allows the reuse of immobilized target sequences with a different set or sets of target probes.

[0119] In some embodiments, amplification of the product of the genotyping reactions is not necessary. For example, in genomes of less complexity, e.g. bacterial, yeast and *Drosophila*, detectable signal is achieved without the need for amplification. This is particularly true when primer extension is performed and more than one base is added to the probe, as is more fully outlined below.

5 [0120] As outlined above, in a preferred embodiment, a plurality of readout probes are used to identify the base at the detection position. In this embodiment, each different readout probe comprises either a different detection label (which, as outlined below, can be either a primary label or a secondary label) or a different adapter, and a different base at the position that will hybridize to the detection position of the target sequence (herein referred to as the readout position) such that differential hybridization will occur.

10 [0121] Accordingly, in some embodiments, a detectable label is incorporated into the readout probe. In a preferred embodiment, a set of readout probes are used, each comprising a different base at the readout position. In some embodiments, each readout probe comprises a different label, that is distinguishable from the others. For example, a first label may be used for probes comprising adenosine at the readout position, a second label may be used for probes comprising guanine at the readout position, etc. In a preferred embodiment, the length and sequence of each readout probe is identical except for the readout position, although this need not be true in all embodiments.

15 [0122] The number of readout probes used will vary depending on the end use of the assay. For example, many SNPs are biallelic, and thus two readout probes, each comprising an interrogation base that will basepair with one of the detection position bases. For sequencing, for example, for the discovery of SNPs, a set of four readout probes are used, although SNPs may also be discovered with fewer readout parameters.

20 [0123] In one embodiment, the probes used as readout probes are "Molecular Beacon" probes as are generally described in Whitcombe et al., *Nature Biotechnology* 17:804 (1999), hereby incorporated by reference. As is known in the art, Molecular Beacon probes form "hairpin" type structures, with a fluorescent label on one end and a quencher on the other. In the absence of the target sequence, the ends of the hairpin hybridize, causing quenching of the label. In the presence of a target sequence, the hairpin structure is lost in favor of target sequence binding, resulting in a loss of quenching and thus an increase in signal.

25 [0124] In a preferred embodiment, extension genotyping is done in combination with ligation. In this embodiment, any number of techniques are used to add a nucleotide to the readout position of a probe hybridized to the target sequence adjacent to the detection position. By relying on enzymatic specificity, preferentially a perfectly complementary base is added. All of these methods rely on the enzymatic incorporation of nucleotides at the detection position. This may be done using chain terminating dNTPs, such that only a single base is incorporated (e.g. single base extension methods), or under conditions that only a single type of nucleotide is added followed by identification of the added nucleotide (extension and pyrosequencing techniques).

30 [0125] Also described is the use of single base extension (SBE; sometimes referred to as "minisequencing") to determine the identity of the base at the detection position. SBE utilizes an extension primer with at least one adapter sequence that hybridizes to the target nucleic acid immediately adjacent to the detection position, to form a hybridization complex. A polymerase (generally a DNA polymerase) is used to extend the 3' end of the primer with a nucleotide analog labeled with a detection label as described herein. Based on the fidelity of the enzyme, a nucleotide is only incorporated into the readout position of the growing nucleic acid strand if it is perfectly complementary to the base in the target strand at the detection position. The nucleotide may be derivatized such that no further extensions can occur, so only a single nucleotide is added. Once the labeled nucleotide is added, detection of the label proceeds as outlined herein. Again, amplification in this case is accomplished through cycling or repeated rounds of reaction/elution, although in some

35 [0126] The reaction is initiated by introducing the hybridization complex comprising the target genomic sequence on the support to a solution comprising a first nucleotide. In general, the nucleotides comprise a detectable label, which may be either a primary or a secondary label. In addition, the nucleotides may be nucleotide analogs, depending on the configuration of the system. For example, if the dNTPs are added in sequential reactions, such that only a single type of dNTP can be added, the nucleotides need not be chain terminating. In addition, in this embodiment, the dNTPs may all comprise the same type of label.

40 [0127] Alternatively, if the reaction comprises more than one dNTP, the dNTPs should be chain terminating, that is, they have a blocking or protecting group at the 3' position such that no further dNTPs may be added by the enzyme. As will be appreciated by those in the art, any number of nucleotide analogs may be used, as long as a polymerase enzyme will still incorporate the nucleotide at the readout position. Preferred embodiments utilize dideoxy-triphosphate nucleotides (ddNTPs) and halogenated dNTPs. Generally, a set of nucleotide comprising ddATP, ddCTP, ddGTP and ddTTP is used, each with a different detectable label, although as outlined herein, this may not be required. Alternative preferred

45 [0128] In addition, as will be appreciated by those in the art, the single base extension reactions allow the precise incorporation of modified bases into a growing nucleic acid strand. Thus, any number of modified nucleotides may be

incorporated for any number of reasons, including probing structure-function relationships (e.g. DNA:DNA or DNA:protein interactions), cleaving the nucleic acid, crosslinking the nucleic acid, incorporate mismatches, etc.

[0129] As will be appreciated by those in the art, the configuration of the genotyping SBE system can take on several forms.

[0130] In addition, since unextended primers do not comprise labels, the unextended primers need not be removed. However, they may be, if desired, as outlined below; for example, if a large excess of primers are used, there may not be sufficient signal from the extended primers competing for binding to the surface.

[0131] Alternatively, one of skill in the art could use a single label and temperature to determine the identity of the base; that is, the readout position of the extension primer hybridizes to a position on the capture probe. However, since the three mismatches will have lower Tms than the perfect match, the use of temperature could elucidate the identity of the detection position base.

Solid phase assay

[0132] The reaction may be done on a surface by capturing the target sequence and then running the SBE reaction, in a sandwich type format schematically depicted in Figure 9A. The capture probe hybridizes to a first domain of the target sequence (which can be endogenous or an exogenous adapter sequence added during an amplification reaction), and the extension primer hybridizes to a second target domain immediately adjacent to the detection position. The addition of the enzyme and the required NTPs results in the addition of the interrogation base. In this embodiment, each NTP must have a unique label. Alternatively, each NTP reaction may be done sequentially on a different array. As is known by one of skill in the art, ddNTP and dNTP are the preferred substrates when DNA polymerase is the added enzyme; NTP is the preferred substrate when RNA polymerase is the added enzyme.

[0133] Furthermore, as is more fully outlined below and depicted in Figure 9D, capture extender probes can be used to attach the target sequence to the bead. The hybridization complex comprises the capture probe, the target sequence and the adapter sequence.

[0134] Similarly, the capture probe itself can be used as the extension probe, with its terminus being directly adjacent to the detection position. This is schematically depicted in Figure 9B. Upon the addition of the target sequence and the SBE reagents, the modified primer is formed comprising a detectable label, and then detected. Again, as for the solution based reaction, each NTP must have a unique label, the reactions must proceed sequentially, or different arrays must be used. Again, as is known by one of skill in the art, ddNTP and dNTP are the preferred substrates when DNA polymerase is the added enzyme; NTP is the preferred substrate when RNA polymerase is the added enzyme.

[0135] Also described are methods in which the specificity for genotyping is provided by a cleavage enzyme. There are a variety of enzymes known to cleave at specific sites, either based on sequence specificity, such as restriction endonucleases, or using structural specificity, such as is done through the use of invasive cleavage technology.

[0136] In a preferred embodiment, the determination of the identity of the base at the detection position of the target sequence proceeds using invasive cleavage technology in combination with ligation. As outlined above for amplification, invasive cleavage techniques rely on the use of structure-specific nucleases, where the structure can be formed as a result of the presence or absence of a mismatch. Generally, invasive cleavage technology may be described as follows. A target nucleic acid is recognized by two distinct probes. A first probe, generally referred to herein as an "invader" probe, is substantially complementary to a first portion of the target nucleic acid. A second probe, generally referred to herein as a "signal probe", is partially complementary to the target nucleic acid; the 3' end of the signal oligonucleotide is substantially complementary to the target sequence while the 5' end is non-complementary and preferably forms a single-stranded "tail" or "arm". The non-complementary end of the second probe preferably comprises a "generic" or "unique" sequence, frequently referred to herein as a "detection sequence", that is used to indicate the presence or absence of the target nucleic acid, as described below. The detection sequence of the second probe may comprise at least one detectable label (for cycling purposes), or preferably comprises one or more universal priming sites and/or an adapter sequence. Alternative methods have the detection sequence functioning as a target sequence for a capture probe, and thus rely on sandwich configurations using label probes.

[0137] Hybridization of the first and second oligonucleotides near or adjacent to one another on the target genomic nucleic acid forms a number of structures.

[0138] Accordingly, the present invention provides methods of determining the identity of a base at the detection position of a target sequence. In this embodiment, the target sequence comprises, 5' to 3', a first target domain comprising an overlap domain comprising at least a nucleotide in the detection position, and a second target domain contiguous with the detection position. A first probe (the "invader probe") is hybridized to the first target domain of the target sequence. A second probe (the "signal probe"), comprising a first portion that hybridizes to the second target domain of the target sequence and a second portion that does not hybridize to the target sequence, is hybridized to the second target domain. If the second probe comprises a base that is perfectly complementary to the detection position a cleavage structure is formed. The addition of a cleavage enzyme, such as is described in U.S. Patent Nos. 5,846,717; 5,614,402; 5,719,029;

5,541,311 and 5,843,669 results in the cleavage of the detection sequence from the signalling probe. This then can be used as a target sequence in an assay complex.

5 **[0139]** In addition, as for a variety of the techniques outlined herein, unreacted probes (i.e. signalling probes, in the case of invasive cleavage), may be removed using any number of techniques. For example, the use of a binding partner coupled to a solid support comprising the other member of the binding pair can be done. Similarly, after cleavage of the primary signal probe, the newly created cleavage products can be selectively labeled at the 3' or 5' ends using enzymatic or chemical methods.

10 **[0140]** Again, as outlined above, the detection of the invasive cleavage reaction can occur directly, in the case where the detection sequence comprises at least one label, or indirectly, using sandwich assays, through the use of additional probes; that is, the detection sequences can serve as target sequences, and detection may utilize amplification probes, capture probes, capture extender probes, label probes, and label extender probes, etc. In one embodiment, a second invasive cleavage reaction is performed on solid-phase thereby making it easier perform multiple reactions.

15 **[0141]** In addition, as for most of the techniques outlined herein, these techniques may be done for the two strands of a double-stranded target sequence. The target sequence is denatured, and two sets of probes are added: one set as outlined above for one strand of the target, and a separate set for the other strand of the target.

[0142] Thus, the invasive cleavage reaction requires, in no particular order, an invader probe, a signalling probe, and a cleavage enzyme.

20 **[0143]** It is possible to combine two or more of these techniques to do genotyping, quantification, detection of sequences, etc., again as outlined in WO 00/63437, including combinations of invasive cleavage and ligation; a combination of OLA and SBE; a combination of OLA and PCR; and a combinations of competitive hybridization and ligation.

25 **[0144]** The present invention provides methods useful in the detection of nucleic acids, particularly the labeled amplicons outlined herein. As is more fully outlined below, preferred systems of the invention work as follows. Amplicons are attached (via hybridization) to an array site. This attachment can be either directly to a capture probe on the surface, through the use of adapters, or indirectly, using capture extender probes as outlined herein. In some embodiments, the target sequence itself comprises the labels. Alternatively, a label probe is then added, forming an assay complex. The attachment of the label probe may be direct (i.e. hybridization to a portion of the target sequence), or indirect (i.e. hybridization to an amplifier probe that hybridizes to the target sequence), with all the required nucleic acids forming an assay complex.

30 **[0145]** Accordingly, described herein are array compositions comprising at least a first substrate with a surface comprising individual sites. By "array" or "biochip" herein is meant a plurality of nucleic acids in an array format; the size of the array will depend on the composition and end use of the array. Nucleic acids arrays are known in the art, and can be classified in a number of ways; both ordered arrays (e.g. the ability to resolve chemistries at discrete sites), and random arrays are included. Ordered arrays include, but are not limited to, those made using photolithography techniques (Affymetrix GeneChip™), spotting techniques (Synteni and others), printing techniques (Hewlett Packard and Rosetta), three dimensional "gel pad" arrays, etc. A preferred embodiment utilizes microspheres on a variety of substrates including fiber optic bundles, as are outlined in PCTs US98/21193, PCT US99/14387 and PCT US98/05025; WO98/50782; and U.S.S.N.s 09/287,573, 09/151,877, 09/256,943, 09/316,154, 60/119,323, 09/315,584. While much of the discussion below is directed to the use of microsphere arrays on fiber optic bundles, any array format of nucleic acids on solid supports may be utilized.

40 **[0146]** Arrays containing from about 2 different bioactive agents (e.g. different beads, when beads are used) to many millions can be made, with very large arrays being possible. Generally, the array will comprise from two to as many as a billion or more, depending on the size of the beads and the substrate, as well as the end use of the array, thus very high density, high density, moderate density, low density and very low density arrays may be made. Preferred ranges for very high density arrays are from about 10,000,000 to about 2,000,000,000, with from about 100,000,000 to about 1,000,000,000 being preferred (all numbers being in square cm). High density arrays range about 100,000 to about 10,000,000, with from about 1,000,000 to about 5,000,000 being particularly preferred. Moderate density arrays range from about 10,000 to about 100,000 being particularly preferred, and from about 20,000 to about 50,000 being especially preferred. Low density arrays are generally less than 10,000, with from about 1,000 to about 5,000 being preferred. Very low density arrays are less than 1,000, with from about 10 to about 1000 being preferred, and from about 100 to about 500 being particularly preferred. In some embodiments, the compositions of the invention may not be in array format; that is, for some embodiments, compositions comprising a single bioactive agent may be made as well. In addition, in some arrays, multiple substrates may be used, either of different or identical compositions. Thus for example, large arrays may comprise a plurality of smaller substrates.

55 **[0147]** In addition, one advantage of the present compositions is that particularly through the use of fiber optic technology, extremely high density arrays can be made. Thus for example, because beads of 200 μm or less (with beads of 200 nm possible) can be used, and very small fibers are known, it is possible to have as many as 40,000 or more (in some instances, 1 million) different elements (e.g. fibers and beads) in a 1 mm² fiber optic bundle, with densities of greater than 25,000,000 individual beads and fibers (again, in some instances as many as 50-100 million) per 0.5 cm²

obtainable (4 million per square cm for 5 μ center-to-center and 100 million per square cm for 1 μ center-to-center).

[0148] By "substrate" or "solid support" or other grammatical equivalents herein is meant any material that can be modified to contain discrete individual sites appropriate for the attachment or association of beads and is amenable to at least one detection method. As will be appreciated by those in the art, the number of possible substrates is very large. Possible substrates include, but are not limited to, glass and modified or functionalized glass, plastics (including acrylics, polystyrene and copolymers of styrene and other materials, polypropylene, polyethylene, polybutylene, polyurethanes, Teflon, etc.), polysaccharides, nylon or nitrocellulose, resins, silica or silica-based materials including silicon and modified silicon, carbon, metals, inorganic glasses, plastics, optical fiber bundles, and a variety of other polymers. In general, the substrates allow optical detection and do not themselves appreciably fluoresce.

[0149] Generally the substrate is flat (planar), although as will be appreciated by those in the art, other configurations of substrates may be used as well; for example, three dimensional configurations can be used, for example by embedding the beads in a porous block of plastic that allows sample access to the beads and using a confocal microscope for detection. Similarly, the beads may be placed on the inside surface of a tube, for flow-through sample analysis to minimize sample volume. Preferred substrates include optical fiber bundles as discussed below, and flat planar substrates such as paper, glass, polystyrene and other plastics and acrylics.

[0150] In a preferred embodiment, the substrate is an optical fiber bundle or array, as is generally described in U.S.S.N.s 08/944,850 and 08/519,062, PCT US98/05025, and PCT US98/09163. Preferred embodiments utilize preformed unitary fiber optic arrays. By "preformed unitary fiber optic array" herein is meant an array of discrete individual fiber optic strands that are co-axially disposed and joined along their lengths. The fiber strands are generally individually clad. However, one thing that distinguished a preformed unitary array from other fiber optic formats is that the fibers are not individually physically manipulatable; that is, one strand generally cannot be physically separated at any point along its length from another fiber strand.

[0151] Generally, the array of array compositions of the invention can be configured in several ways; see for example U.S.S.N. 09/473,904. In a preferred embodiment, as is more fully outlined below, a "one component" system is used. That is, a first substrate comprising a plurality of assay locations (sometimes also referred to herein as "assay wells"), such as a microtiter plate, is configured such that each assay location contains an individual array. That is, the assay location and the array location are the same. For example, the plastic material of the microtiter plate can be formed to contain a plurality of "bead wells" in the bottom of each of the assay wells. Beads containing the capture probes of the invention can then be loaded into the bead wells in each assay location as is more fully described below.

[0152] Alternatively, a "two component" system can be used. In this embodiment, the individual arrays are formed on a second substrate, which then can be fitted or "dipped" into the first microtiter plate substrate. A preferred embodiment utilizes fiber optic bundles as the individual arrays, generally with "bead wells" etched into one surface of each individual fiber, such that the beads containing the capture probes are loaded onto the end of the fiber optic bundle. The composite array thus comprises a number of individual arrays that are configured to fit within the wells of a microtiter plate.

[0153] By "composite array" or "combination array" or grammatical equivalents herein is meant a plurality of individual arrays, as outlined above. Generally the number of individual arrays is set by the size of the microtiter plate used; thus, 96 well, 384 well and 1536 well microtiter plates utilize composite arrays comprising 96, 384 and 1536 individual arrays, although as will be appreciated by those in the art, not each microtiter well need contain an individual array. It should be noted that the composite arrays can comprise individual arrays that are identical, similar or different. That is, in some embodiments, it may be desirable to do the same 2,000 assays on 96 different samples; alternatively, doing 192,000 experiments on the same sample (i.e. the same sample in each of the 96 wells) may be desirable. Alternatively, each row or column of the composite array could be the same, for redundancy/quality control. As will be appreciated by those in the art, there are a variety of ways to configure the system. In addition, the random nature of the arrays may mean that the same population of beads may be added to two different surfaces, resulting in substantially similar but perhaps not identical arrays.

[0154] At least one surface of the substrate is modified to contain discrete, individual sites for later association of microspheres. These sites may comprise physically altered sites, i.e. physical configurations such as wells or small depressions in the substrate that can retain the beads, such that a microsphere can rest in the well, or the use of other forces (magnetic or compressive), or chemically altered or active sites, such as chemically functionalized sites, electrostatically altered sites, hydrophobically/ hydrophilically functionalized sites, spots of adhesive, etc.

[0155] The sites may be a pattern, i.e. a regular design or configuration, or randomly distributed. A preferred embodiment utilizes a regular pattern of sites such that the sites may be addressed in the X-Y coordinate plane. "Pattern" in this sense includes a repeating unit cell, preferably one that allows a high density of beads on the substrate. However, it should be noted that these sites may not be discrete sites. That is, it is possible to use a uniform surface of adhesive or chemical functionalities, for example, that allows the attachment of beads at any position. That is, the surface of the substrate is modified to allow attachment of the microspheres at individual sites, whether or not those sites are contiguous or non-contiguous with other sites. Thus, the surface of the substrate may be modified such that discrete sites are formed that can only have a single associated bead, or alternatively, the surface of the substrate is modified and beads may go

down anywhere, but they end up at discrete sites. That is, while beads need not occupy each site on the array, no more than one bead occupies each site.

5 [0156] In a preferred embodiment, the surface of the substrate is modified to contain wells, i.e. depressions in the surface of the substrate. This may be done as is generally known in the art using a variety of techniques, including, but not limited to, photolithography, stamping techniques, molding techniques and microetching techniques. As will be appreciated by those in the art, the technique used will depend on the composition and shape of the substrate.

10 [0157] In a preferred embodiment, physical alterations are made in a surface of the substrate to produce the sites. In a preferred embodiment, the substrate is a fiber optic bundle and the surface of the substrate is a terminal end of the fiber bundle, as is generally described in 08/818,199 and 09/151,877. In this embodiment, wells are made in a terminal or distal end of a fiber optic bundle comprising individual fibers. In this embodiment, the cores of the individual fibers are etched, with respect to the cladding, such that small wells or depressions are formed at one end of the fibers. The required depth of the wells will depend on the size of the beads to be added to the wells.

15 [0158] Generally in this embodiment, the microspheres are non-covalently associated in the wells, although the wells may additionally be chemically functionalized as is generally described below, cross-linking agents may be used, or a physical barrier may be used, i.e. a film or membrane over the beads.

20 [0159] In a preferred embodiment, the surface of the substrate is modified to contain chemically modified sites, that can be used to attach, either covalently or non-covalently, the microspheres of the invention to the discrete sites or locations on the substrate. "Chemically modified sites" in this context includes, but is not limited to, the addition of a pattern of chemical functional groups including amino groups, carboxy groups, oxo groups and thiol groups, that can be used to covalently attach microspheres, which generally also contain corresponding reactive functional groups; the addition of a pattern of adhesive that can be used to bind the microspheres (either by prior chemical functionalization for the addition of the adhesive or direct addition of the adhesive); the addition of a pattern of charged groups (similar to the chemical functionalities) for the electrostatic attachment of the microspheres, i.e. when the microspheres comprise charged groups opposite to the sites; the addition of a pattern of chemical functional groups that renders the sites differentially hydrophobic or hydrophilic, such that the addition of similarly hydrophobic or hydrophilic microspheres under suitable experimental conditions will result in association of the microspheres to the sites on the basis of hydroaffinity. For example, the use of hydrophobic sites with hydrophobic beads, in an aqueous system, drives the association of the beads preferentially onto the sites. As outlined above, "pattern" in this sense includes the use of a uniform treatment of the surface to allow attachment of the beads at discrete sites, as well as treatment of the surface resulting in discrete sites. As will be appreciated by those in the art, this may be accomplished in a variety of ways.

30 [0160] In some embodiments, the beads are not associated with a substrate. That is, the beads are in solution or are not distributed on a patterned substrate.

35 [0161] Compositions herein described further comprise a population of microspheres. By "population" herein is meant a plurality of beads as outlined above for arrays. Within the population are separate subpopulations, which can be a single microsphere or multiple identical microspheres. That is, in some embodiments, as is more fully outlined below, the array may contain only a single bead for each capture probe; preferred embodiments utilize a plurality of beads of each type.

40 [0162] By "microspheres" or "beads" or "particles" or grammatical equivalents herein is meant small discrete particles. The composition of the beads will vary, depending on the class of capture probe and the method of synthesis. Suitable bead compositions include those used in peptide, nucleic acid and organic moiety synthesis, including, but not limited to, plastics, ceramics, glass, polystyrene, methylstyrene, acrylic polymers, paramagnetic materials, thoria sol, carbon graphite, titanium dioxide, latex or cross-linked dextrans such as Sepharose, cellulose, nylon, cross-linked micelles and Teflon may all be used. "Microsphere Detection Guide" from Bangs Laboratories, Fishers IN is a helpful guide.

45 [0163] The beads need not be spherical; irregular particles may be used. In addition, the beads may be porous, thus increasing the surface area of the bead available for either capture probe attachment or tag attachment. The bead sizes range from nanometers, i.e. 100 nm, to millimeters, i.e. 1 mm, with beads from about 0.2 micron to about 200 microns being preferred, and from about 0.5 to about 5 micron being particularly preferred, although in some embodiments smaller beads may be used.

50 [0164] It should be noted that a key component is the use of a substrate/bead pairing that allows the association or attachment of the beads at discrete sites on the surface of the substrate, such that the beads do not move during the course of the assay.

[0165] Each microsphere comprises a capture probe, although as will be appreciated by those in the art, there may be some microspheres which do not contain a capture probe, depending on the synthetic methods.

55 [0166] Attachment of the nucleic acids may be done in a variety of ways, as will be appreciated by those in the art, including, but not limited to, chemical or affinity capture (for example, including the incorporation of derivatized nucleotides such as AminoLink or biotinylated nucleotides that can then be used to attach the nucleic acid to a surface, as well as affinity capture by hybridization), cross-linking, and electrostatic attachment, etc. In a preferred embodiment, affinity capture is used to attach the nucleic acids to the beads. For example, nucleic acids can be derivatized, for example with

one member of a binding pair, and the beads derivatized with the other member of a binding pair. Suitable binding pairs are as described herein for IBL/DBL pairs. For example, the nucleic acids may be biotinylated (for example using enzymatic incorporation of biotinylated nucleotides, or by photoactivated cross-linking of biotin). Biotinylated nucleic acids can then be captured on streptavidin-coated beads, as is known in the art. Similarly, other hapten-receptor combinations can be used, such as digoxigenin and anti-digoxigenin antibodies. Alternatively, chemical groups can be added in the form of derivatized nucleotides, that can then be used to add the nucleic acid to the surface.

[0167] Preferred attachments are covalent, although even relatively weak interactions (i.e. non-covalent) can be sufficient to attach a nucleic acid to a surface, if there are multiple sites of attachment per each nucleic acid. Thus, for example, electrostatic interactions can be used for attachment, for example by having beads carrying the opposite charge to the bioactive agent.

[0168] Similarly, affinity capture utilizing hybridization can be used to attach nucleic acids to beads.

[0169] Alternatively, chemical crosslinking may be done, for example by photoactivated crosslinking of thymidine to reactive groups, as is known in the art

[0170] In a preferred embodiment, each bead comprises a single type of capture probe, although a plurality of individual capture probes are preferably attached to each bead. Similarly, preferred embodiments utilize more than one microsphere containing a unique capture probe; that is, there is redundancy built into the system by the use of subpopulations of microspheres, each microsphere in the subpopulation containing the same capture probe.

[0171] As will be appreciated by those in the art, the capture probes may either be synthesized directly on the beads, or they may be made and then attached after synthesis. In a preferred embodiment, linkers are used to attach the capture probes to the beads, to allow both good attachment, sufficient flexibility to allow good interaction with the target molecule, and to avoid undesirable binding reactions.

[0172] In a preferred embodiment, the capture probes are synthesized directly on the beads. As is known in the art, many classes of chemical compounds are currently synthesized on solid supports, such as peptides, organic moieties, and nucleic acids. It is a relatively straightforward matter to adjust the current synthetic techniques to use beads.

[0173] In a preferred embodiment, the capture probes are synthesized first, and then covalently attached to the beads. As will be appreciated by those in the art, this will be done depending on the composition of the capture probes and the beads. The functionalization of solid support surfaces such as certain polymers with chemically reactive groups such as thiols, amines, carboxyls, etc. is generally known in the art. Accordingly, "blank" microspheres may be used that have surface chemistries that facilitate the attachment of the desired functionality by the user. Some examples of these surface chemistries for blank microspheres include, but are not limited to, amino groups including aliphatic and aromatic amines, carboxylic acids, aldehydes, amides, chloromethyl groups, hydrazide, hydroxyl groups, sulfonates and sulfates.

[0174] When random arrays are used, an encoding/decoding system must be used. For example, when microsphere arrays are used, the beads are generally put onto the substrate randomly; as such there are several ways to correlate the functionality on the bead with its location, including the incorporation of unique optical signatures, generally fluorescent dyes, that could be used to identify the nucleic acid on any particular bead. This allows the synthesis of the capture probes to be divorced from their placement on an array, i.e. the capture probes may be synthesized on the beads, and then the beads are randomly distributed on a patterned surface. Since the beads are first coded with an optical signature, this means that the array can later be "decoded", i.e. after the array is made, a correlation of the location of an individual site on the array with the bead or probe at that particular site can be made. This means that the beads may be randomly distributed on the array, a fast and inexpensive process as compared to either the in situ synthesis or spotting techniques of the prior art.

[0175] However, the drawback to these methods is that for a large array, the system requires a large number of different optical signatures, which may be difficult or time-consuming to utilize. Accordingly, the present invention provides several improvements over these methods, generally directed to methods of coding and decoding the arrays. That is, as will be appreciated by those in the art, the placement of the capture probes is generally random, and thus a coding/decoding system is required to identify the probe at each location in the array. This may be done in a variety of ways, as is more fully outlined below, and generally includes: a) the use of a decoding binding ligand (DBL), generally directly labeled, that binds to either the capture probe or to identifier binding ligands (IBLs) attached to the beads; b) positional decoding, for example by either targeting the placement of beads (for example by using photoactivatable or photocleavable moieties to allow the selective addition of beads to particular locations), or by using either sub-bundles or selective loading of the sites, as are more fully outlined below; c) selective decoding, wherein only those beads that bind to a target are decoded; or d) combinations of any of these. In some cases, as is more fully outlined below, this decoding may occur for all the beads, or only for those that bind a particular target sequence. Similarly, this may occur either prior to or after addition of a target sequence. In addition, as outlined herein, the target sequences detected may be either a primary target sequence (e.g. a patient sample), or a reaction product from one of the methods described herein (e.g. an extended SBE probe, a ligated probe, a cleaved signal probe, etc.).

[0176] Once the identity (i.e. the actual agent) and location of each microsphere in the array has been fixed, the array is exposed to samples containing the target sequences, although as outlined below, this can be done prior to or during

the analysis as well. The target sequences can hybridize (either directly or indirectly) to the capture probes as is more fully outlined below, and results in a change in the optical signal of a particular bead.

[0177] In the present invention, "decoding" does not rely on the use of optical signatures, but rather on the use of decoding binding ligands that are added during a decoding step. The decoding binding ligands will bind either to a distinct identifier binding ligand partner that is placed on the beads, or to the capture probe itself. The decoding binding ligands are either directly or indirectly labeled, and thus decoding occurs by detecting the presence of the label. By using pools of decoding binding ligands in a sequential fashion, it is possible to greatly minimize the number of required decoding steps.

[0178] In some embodiments, the microspheres may additionally comprise identifier binding ligands for use in certain decoding systems. By "identifier binding ligands" or "IBLs" herein is meant a compound that will specifically bind a corresponding decoder binding ligand (DBL) to facilitate the elucidation of the identity of the capture probe attached to the bead. That is, the IBL and the corresponding DBL form a binding partner pair. By "specifically bind" herein is meant that the IBL binds its DBL with specificity sufficient to differentiate between the corresponding DBL and other DBLs (that is, DBLs for other IBLs), or other components or contaminants of the system. The binding should be sufficient to remain bound under the conditions of the decoding step, including wash steps to remove non-specific binding. In some embodiments, for example when the IBLs and corresponding DBLs are proteins or nucleic acids, the dissociation constants of the IBL to its DBL will be less than about 10^{-4} - 10^{-6} M⁻¹, with less than about 10^{-5} to 10^{-9} M⁻¹ being preferred and less than about 10^{-7} - 10^{-9} M⁻¹ being particularly preferred.

[0179] IBL-DBL binding pairs are known or can be readily found using known techniques. For example, when the IBL is a protein, the DBLs include proteins (particularly including antibodies or fragments thereof (FABs, etc.)) or small molecules, or vice versa (the IBL is an antibody and the DBL is a protein). Metal ion-metal ion ligands or chelators pairs are also useful. Antigen-antibody pairs, enzymes and substrates or inhibitors, other protein-protein interacting pairs, receptor-ligands, complementary nucleic acids, and carbohydrates and their binding partners are also suitable binding pairs. Nucleic acid - nucleic acid binding proteins pairs are also useful. Similarly, as is generally described in U.S. Patents 5,270,163, 5,475,096, 5,567,588, 5,595,877, 5,637,459, 5,683,867, 5,705,337, and related patents, nucleic acid "aptamers" can be developed for binding to virtually any target; such an aptamer-target pair can be used as the IBL-DBL pair. Similarly, there is a wide body of literature relating to the development of binding pairs based on combinatorial chemistry methods.

[0180] In a preferred embodiment, the IBL is a molecule whose color or luminescence properties change in the presence of a selectively-binding DBL. For example, the IBL may be a fluorescent pH indicator whose emission intensity changes with pH. Similarly, the IBL may be a fluorescent ion indicator, whose emission properties change with ion concentration.

[0181] Alternatively, the IBL is a molecule whose color or luminescence properties change in the presence of various solvents. For example, the IBL may be a fluorescent molecule such as an ethidium salt whose fluorescence intensity increases in hydrophobic environments. Similarly, the IBL may be a derivative of fluorescein whose color changes between aqueous and nonpolar solvents.

[0182] In one embodiment, the DBL may be attached to a bead, i.e. a "decoder bead", that may carry a label such as a fluorophore.

[0183] In a preferred embodiment, the IBL-DBL pair comprise substantially complementary single-stranded nucleic acids. In this embodiment, the binding ligands can be referred to as "identifier probes" and "decoder probes". Generally, the identifier and decoder probes range from about 4 basepairs in length to about 1000, with from about 6 to about 100 being preferred, and from about 8 to about 40 being particularly preferred. What is important is that the probes are long enough to be specific, i.e. to distinguish between different IBL-DBL pairs, yet short enough to allow both a) dissociation, if necessary, under suitable experimental conditions, and b) efficient hybridization.

[0184] In a preferred embodiment, as is more fully outlined below, the IBLs do not bind to DBLs. Rather, the IBLs are used as identifier moieties ("IMs") that are identified directly, for example through the use of mass spectroscopy.

[0185] Alternatively, in a preferred embodiment, the IBL and the capture probe are the same moiety; thus, for example, as outlined herein, particularly when no optical signatures are used, the capture probe can serve as both the identifier and the agent. For example, in the case of nucleic acids, the bead-bound probe (which serves as the capture probe) can also bind decoder probes, to identify the sequence of the probe on the bead. Thus, in this embodiment, the DBLs bind to the capture probes.

[0186] In a preferred embodiment, the microspheres may contain an optical signature. That is, as outlined in U.S.S.N.s 08/818,199 and 09/151,877, previous work had each subpopulation of microspheres comprising a unique optical signature or optical tag that is used to identify the unique capture probe of that subpopulation of microspheres; that is, decoding utilizes optical properties of the beads such that a bead comprising the unique optical signature may be distinguished from beads at other locations with different optical signatures. Thus the previous work assigned each capture probe a unique optical signature such that any microspheres comprising that capture probe are identifiable on the basis of the signature. These optical signatures comprised dyes, usually chromophores or fluorophores, that were entrapped or attached to the beads themselves. Diversity of optical signatures utilized different fluorochromes, different

ratios of mixtures of fluorochromes, and different concentrations (intensities) of fluorochromes.

5 **[0187]** In a preferred embodiment, the present invention does not rely solely on the use of optical properties to decode the arrays. However, as will be appreciated by those in the art, it is possible in some embodiments to utilize optical signatures as an additional coding method, in conjunction with the present system. Thus, for example, as is more fully outlined below, the size of the array may be effectively increased while using a single set of decoding moieties in several ways, one of which is the use of optical signatures on some beads. Thus, for example, using one "set" of decoding molecules, the use of two populations of beads, one with an optical signature and one without, allows the effective doubling of the array size. The use of multiple optical signatures similarly increases the possible size of the array.

10 **[0188]** In a preferred embodiment, each subpopulation of beads comprises a plurality of different IBLs. By using a plurality of different IBLs to encode each capture probe, the number of possible unique codes is substantially increased. That is, by using one unique IBL per capture probe, the size of the array will be the number of unique IBLs (assuming no "reuse" occurs, as outlined below). However, by using a plurality of different IBLs per bead, n , the size of the array can be increased to 2^n , when the presence or absence of each IBL is used as the indicator. For example, the assignment of 10 IBLs per bead generates a 10 bit binary code, where each bit can be designated as "1" (IBL is present) or "0" (IBL is absent). A 10 bit binary code has 2^{10} possible variants. However, as is more fully discussed below, the size of the array may be further increased if another parameter is included such as concentration or intensity; thus for example, if two different concentrations of the IBL are used, then the array size increases as 3^n . Thus, in this embodiment, each individual capture probe in the array is assigned a combination of IBLs, which can be added to the beads prior to the addition of the capture probe, after, or during the synthesis of the capture probe, i.e. simultaneous addition of IBLs and capture probe components.

20 **[0189]** Alternatively, the combination of different IBLs can be used to elucidate the sequence of the nucleic acid. Thus, for example, using two different IBLs (IBL1 and IBL2); the first position of a nucleic acid can be elucidated: for example, adenosine can be represented by the presence of both IBL1 and IBL2; thymidine can be represented by the presence of IBL1 but not IBL2, cytosine can be represented by the presence of IBL2 but not IBL1, and guanosine can be represented by the absence of both. The second position of the nucleic acid can be done in a similar manner using IBL3 and IBL4; thus, the presence of IBL1, IBL2, IBL3 and IBL4 gives a sequence of AA; IBL1, IBL2, and IBL3 shows the sequence AT; IBL1, IBL3 and IBL4 gives the sequence TA, etc. The third position utilizes IBL5 and IBL6, etc. in this way, the use of 20 different identifiers can yield a unique code for every possible 10-mer.

25 **[0190]** In this way, a sort of "bar code" for each sequence can be constructed; the presence or absence of each distinct IBL will allow the identification of each capture probe.

30 **[0191]** In addition, the use of different concentrations or densities of IBLs allows a "reuse" of sorts. If, for example, the bead comprising a first agent has a 1X concentration of IBL, and a second bead comprising a second agent has a 10X concentration of IBL, using saturating concentrations of the corresponding labelled DBL allows the user to distinguish between the two beads.

35 **[0192]** Once the microspheres comprising the capture probes are generated, they are added to the substrate to form an array. It should be noted that while most of the methods described herein add the beads to the substrate prior to the assay, the order of making, using and decoding the array can vary. For example, the array can be made, decoded, and then the assay done. Alternatively, the array can be made, used in an assay, and then decoded; this may find particular use when only a few beads need be decoded. Alternatively, the beads can be added to the assay mixture, i.e. the sample containing the target sequences, prior to the addition of the beads to the substrate; after addition and assay, the array may be decoded. This is particularly preferred when the sample comprising the beads is agitated or mixed; this can increase the amount of target sequence bound to the beads per unit time, and thus (in the case of nucleic acid assays) increase the hybridization kinetics. This may find particular use in cases where the concentration of target sequence in the sample is low; generally, for low concentrations, long binding times must be used.

40 **[0193]** In general, the methods of making the arrays and of decoding the arrays is done to maximize the number of different candidate agents that can be uniquely encoded. The compositions of the invention may be made in a variety of ways. In general, the arrays are made by adding a solution or slurry comprising the beads to a surface containing the sites for attachment of the beads. This may be done in a variety of buffers, including aqueous and organic solvents, and mixtures. The solvent can evaporate, and excess beads are removed.

45 **[0194]** When non-covalent methods are used to associate the beads with the array, a novel method of loading the beads onto the array is used. This method comprises exposing the array to a solution of particles (including microspheres and cells) and then applying energy, e.g. agitating or vibrating the mixture. This results in an array comprising more tightly associated particles, as the agitation is done with sufficient energy to cause weakly-associated beads to fall off (or out, in the case of wells). These sites are then available to bind a different bead. In this way, beads that exhibit a high affinity for the sites are selected. Arrays made in this way have two main advantages as compared to a more static loading: first of all, a higher percentage of the sites can be filled easily, and secondly, the arrays thus loaded show a substantial decrease in bead loss during assays. Thus, these methods are used to generate arrays that have at least about 50% of the sites filled, with at least about 75% being preferred, and at least about 90% being particularly preferred.

Similarly, arrays generated in this manner preferably lose less than about 20% of the beads during an assay, with less than about 10% being preferred and less than about 5% being particularly preferred.

5 [0195] The substrate comprising the surface with the discrete sites is immersed into a solution comprising the particles (beads, cells, etc.). The surface may comprise wells, as is described herein, or other types of sites on a patterned surface such that there is a differential affinity for the sites. This differential affinity results in a competitive process, such that particles that will associate more tightly are selected. Preferably, the entire surface to be "loaded" with beads is in fluid contact with the solution. This solution is generally a slurry ranging from about 10,000:1 beads:solution (vol:vol) to 1:1. Generally, the solution can comprise any number of reagents, including aqueous buffers, organic solvents, salts, other reagent components, etc. In addition, the solution preferably comprises an excess of beads; that is, there are more beads than sites on the array. Preferred embodiments utilize two-fold to billion-fold excess of beads.

10 [0196] The immersion can mimic the assay conditions; for example, if the array is to be "dipped" from above into a microtiter plate comprising samples, this configuration can be repeated for the loading, thus minimizing the beads that are likely to fall out due to gravity.

15 [0197] Once the surface has been immersed, the substrate, the solution, or both are subjected to a competitive process, whereby the particles with lower affinity can be disassociated from the substrate and replaced by particles exhibiting a higher affinity to the site. This competitive process is done by the introduction of energy, in the form of heat, sonication, stirring or mixing, vibrating or agitating the solution or substrate, or both.

20 [0198] Described herein are methods that utilize agitation or vibration. In general, the amount of manipulation of the substrate is minimized to prevent damage to the array; thus the methods utilize the agitation of the solution rather than the array, although either will work. As will be appreciated by those in the art, this agitation can take on any number of forms, e.g. utilizing microtiter plates comprising bead solutions being agitated using microtiter plate shakers.

[0199] The agitation proceeds for a period of time sufficient to load the array to a desired fill. Depending on the size and concentration of the beads and the size of the array, this time may range from about 1 second to days, with from about 1 minute to about 24 hours being preferred.

25 [0200] It should be noted that not all sites of an array may comprise a bead; that is, there may be some sites on the substrate surface which are empty. In addition, there may be some sites that contain more than one bead, although this is not preferred.

30 [0201] For example when chemical attachment is done, it is possible to attach the beads in a non-random or ordered way. For example, using photoactivatable attachment linkers or photoactivatable adhesives or masks, selected sites on the array may be sequentially rendered suitable for attachment, such that defined populations of beads are laid down.

[0202] The arrays are constructed such that information about the identity of the capture probe is built into the array, such that the random deposition of the beads in the fiber wells can be "decoded" to allow identification of the capture probe at all positions. This may be done in a variety of ways, and either before, during or after the use of the array to detect target molecules.

35 [0203] Thus, after the array is made, it is "decoded" in order to identify the location of one or more of the capture probes, i.e. each subpopulation of beads, on the substrate surface.

[0204] In a preferred embodiment, pyrosequencing techniques are used to decode the array, as is generally described in "Nucleic Acid Sequencing Using Microsphere Arrays", filed October 22, 1999 (no U.S.S.N. received yet).

40 [0205] In a preferred embodiment, a selective decoding system is used. In this case, only those microspheres exhibiting a change in the optical signal as a result of the binding of a target sequence are decoded. This is commonly done when the number of "hits", i.e. the number of sites to decode, is generally low. That is, the array is first scanned under experimental conditions in the absence of the target sequences. The sample containing the target sequences is added, and only those locations exhibiting a change in the optical signal are decoded. For example, the beads at either the positive or negative signal locations may be either selectively tagged or released from the array (for example through the use of photocleavable linkers), and subsequently sorted or enriched in a fluorescence-activated cell sorter (FACS). That is, either all the negative beads are released, and then the positive beads are either released or analyzed in situ, or alternatively all the positives are released and analyzed. Alternatively, the labels may comprise halogenated aromatic compounds, and detection of the label is done using for example gas chromatography, chemical tags, isotopic tags mass spectral tags.

45 [0206] As will be appreciated by those in the art, this may also be done in systems where the array is not decoded; i.e. there need not ever be a correlation of bead composition with location. In this embodiment, the beads are loaded on the array, and the assay is run. The "positives", i.e. those beads displaying a change in the optical signal as is more fully outlined below, are then "marked" to distinguish or separate them from the "negative" beads. This can be done in several ways, preferably using fiber optic arrays. In a preferred embodiment, each bead contains a fluorescent dye. After the assay and the identification of the "positives" or "active beads", light is shown down either only the positive fibers or only the negative fibers, generally in the presence of a light-activated reagent (typically dissolved oxygen). In the former case, all the active beads are photobleached. Thus, upon non-selective release of all the beads with subsequent sorting, for example using a fluorescence activated cell sorter (FACS) machine, the non-fluorescent active beads can

be sorted from the fluorescent negative beads. Alternatively, when light is shown down the negative fibers, all the negatives are non-fluorescent and the the positives are fluorescent, and sorting can proceed. The characterization of the attached capture probe may be done directly, for example using mass spectroscopy.

5 [0207] Alternatively, the identification may occur through the use of identifier moieties ("IMs"), which are similar to IBLs but need not necessarily bind to DBLs. That is, rather than elucidate the structure of the capture probe directly, the composition of the IMs may serve as the identifier. Thus, for example, a specific combination of IMs can serve to code the bead, and be used to identify the agent on the bead upon release from the bead followed by subsequent analysis, for example using a gas chromatograph or mass spectroscopy.

10 [0208] Alternatively, rather than having each bead contain a fluorescent dye, each bead comprises a non-fluorescent precursor to a fluorescent dye. For example, using photocleavable protecting groups, such as certain ortho-nitrobenzyl groups, on a fluorescent molecule, photoactivation of the fluorochrome can be done. After the assay, light is shown down again either the "positive" or the "negative" fibers, to distinguish these populations. The illuminated precursors are then chemically converted to a fluorescent dye. All the beads are then released from the array, with sorting, to form populations of fluorescent and non-fluorescent beads (either the positives and the negatives or vice versa).

15 [0209] In an alternate preferred embodiment, the sites of attachment of the beads (for example the wells) include a photopolymerizable reagent, or the photopolymerizable agent is added to the assembled array. After the test assay is run, light is shown down again either the "positive" or the "negative" fibers, to distinguish these populations. As a result of the irradiation, either all the positives or all the negatives are polymerized and trapped or bound to the sites, while the other population of beads can be released from the array.

20 [0210] In a preferred embodiment, the location of every capture probe is determined using decoder binding ligands (DBLs). As outlined above, DBLs are binding ligands that will either bind to identifier binding ligands, if present, or to the capture probes themselves, preferably when the capture probe is a nucleic acid or protein.

[0211] In a preferred embodiment, as outlined above, the DBL binds to the IBL.

25 [0212] In a preferred embodiment, the capture probes are single-stranded nucleic acids and the DBL is a substantially complementary single-stranded nucleic acid that binds (hybridizes) to the capture probe, termed a decoder probe herein. A decoder probe that is substantially complementary to each candidate probe is made and used to decode the array. In this embodiment, the candidate probes and the decoder probes should be of sufficient length (and the decoding step run under suitable conditions) to allow specificity; i.e. each candidate probe binds to its corresponding decoder probe with sufficient specificity to allow the distinction of each candidate probe.

30 [0213] In a preferred embodiment, the DBLs are either directly or indirectly labeled. In a preferred embodiment, the DBL is directly labeled, that is, the DBL comprises a label. In an alternate embodiment, the DBL is indirectly labeled; that is, a labeling binding ligand (LBL) that will bind to the DBL is used. In this embodiment, the labeling binding ligand-DBL pair can be as described above for IBL-DBL pairs.

35 [0214] Accordingly, the identification of the location of the individual beads (or subpopulations of beads) is done using one or more decoding steps comprising a binding between the labeled DBL and either the IBL or the capture probe (i.e. a hybridization between the candidate probe and the decoder probe when the capture probe is a nucleic acid). After decoding, the DBLs can be removed and the array can be used; however, in some circumstances, for example when the DBL binds to an IBL and not to the capture probe, the removal of the DBL is not required (although it may be desirable in some circumstances). In addition, as outlined herein, decoding may be done either before the array is used to in an assay, during the assay, or after the assay.

40 [0215] In one embodiment, a single decoding step is done. In this embodiment, each DBL is labeled with a unique label, such that the the number of unique tags is equal to or greater than the number of capture probes (although in some cases, "reuse" of the unique labels can be done, as described herein; similarly, minor variants of candidate probes can share the same decoder, if the variants are encoded in another dimension, i.e. in the bead size or label). For each capture probe or IBL, a DBL is made that will specifically bind to it and contains a unique tag, for example one or more fluorochromes. Thus, the identity of each DBL, both its composition (i.e. its sequence when it is a nucleic acid) and its label, is known. Then, by adding the DBLs to the array containing the capture probes under conditions which allow the formation of complexes (termed hybridization complexes when the components are nucleic acids) between the DBLs and either the capture probes or the IBLs, the location of each DBL can be elucidated. This allows the identification of the location of each capture probe; the random array has been decoded. The DBLs can then be removed, if necessary, and the target sample applied.

45 [0216] In a preferred embodiment, the number of unique labels is less than the number of unique capture probes, and thus a sequential series of decoding steps are used. In this embodiment, decoder probes are divided into n sets for decoding. The number of sets corresponds to the number of unique tags. Each decoder probe is labeled in n separate reactions with n distinct tags. All the decoder probes share the same n tags. The decoder probes are pooled so that each pool contains only one of the n tag versions of each decoder, and no two decoder probes have the same sequence of tags across all the pools. The number of pools required for this to be true is determined by the number of decoder probes and the n. Hybridization of each pool to the array generates a signal at every address. The sequential hybridization

of each pool in turn will generate a unique, sequence-specific code for each candidate probe. This identifies the candidate probe at each address in the array. For example, if four tags are used, then $4 \times n$ sequential hybridizations can ideally distinguish 4^n sequences, although in some cases more steps may be required. After the hybridization of each pool, the hybrids are denatured and the decoder probes removed, so that the probes are rendered single-stranded for the next hybridization (although it is also possible to hybridize limiting amounts of target so that the available probe is not saturated). Sequential hybridizations can be carried out and analyzed by subtracting pre-existing signal from the previous hybridization).

[0217] An example is illustrative. Assuming an array of 16 probe nucleic acids (numbers 1-16), and four unique tags (four different fluors, for example; labels A-D). Decoder probes 1-16 are made that correspond to the probes on the beads. The first step is to label decoder probes 1-4 with tag A, decoder probes 5-8 with tag B, decoder probes 9-12 with tag C, and decoder probes 13-16 with tag D. The probes are mixed and the pool is contacted with the array containing the beads with the attached candidate probes. The location of each tag (and thus each decoder and candidate probe pair) is then determined. The first set of decoder probes are then removed. A second set is added, but this time, decoder probes 1, 5, 9 and 13 are labeled with tag A, decoder probes 2, 6, 10 and 14 are labeled with tag B, decoder probes 3, 7, 11 and 15 are labeled with tag C, and decoder probes 4, 8, 12 and 16 are labeled with tag D. Thus, those beads that contained tag A in both decoding steps contain candidate probe 1; tag A in the first decoding step and tag B in the second decoding step contain candidate probe 2; tag A in the first decoding step and tag C in the second step contain candidate probe 3; etc. In one embodiment, the decoder probes are labeled in situ; that is, they need not be labeled prior to the decoding reaction. In this embodiment, the incoming decoder probe is shorter than the candidate probe, creating a 5' "overhang" on the decoding probe. The addition of labeled ddNTPs (each labeled with a unique tag) and a polymerase will allow the addition of the tags in a sequence specific manner, thus creating a sequence-specific pattern of signals. Similarly, other modifications can be done, including ligation, etc.

[0218] In addition, since the size of the array will be set by the number of unique decoding binding ligands, it is possible to "reuse" a set of unique DBLs to allow for a greater number of test sites. This may be done in several ways; for example, by using some subpopulations that comprise optical signatures. Similarly, the use of a positional coding scheme within an array; different sub-bundles may reuse the set of DBLs. Similarly, one embodiment utilizes bead size as a coding modality, thus allowing the reuse of the set of unique DBLs for each bead size. Alternatively, sequential partial loading of arrays with beads can also allow the reuse of DBLs. Furthermore, "code sharing" can occur as well.

[0219] In a preferred embodiment, the DBLs may be reused by having some subpopulations of beads comprise optical signatures. In a preferred embodiment, the optical signature is generally a mixture of reporter dyes, preferably fluorescent. By varying both the composition of the mixture (i.e. the ratio of one dye to another) and the concentration of the dye (leading to differences in signal intensity), matrices of unique optical signatures may be generated. This may be done by covalently attaching the dyes to the surface of the beads, or alternatively, by entrapping the dye within the bead.

[0220] In a preferred embodiment, the encoding can be accomplished in a ratio of at least two dyes, although more encoding dimensions may be added in the size of the beads, for example. In addition, the labels are distinguishable from one another, thus two different labels may comprise different molecules (i.e. two different fluors) or, alternatively, one label at two different concentrations or intensity.

[0221] In a preferred embodiment, the dyes are covalently attached to the surface of the beads. This may be done as is generally outlined for the attachment of the capture probes, using functional groups on the surface of the beads. As will be appreciated by those in the art, these attachments are done to minimize the effect on the dye.

[0222] In a preferred embodiment, the dyes are non-covalently associated with the beads, generally by entrapping the dyes in the pores of the beads.

[0223] Additionally, encoding in the ratios of the two or more dyes, rather than single dye concentrations, is preferred since it provides insensitivity to the intensity of light used to interrogate the reporter dye's signature and detector sensitivity.

[0224] In a preferred embodiment, a spatial or positional coding system is done. In this embodiment, there are sub-bundles or subarrays (i.e. portions of the total array) that are utilized. By analogy with the telephone system, each subarray is an "area code", that can have the same tags (i.e. telephone numbers) of other subarrays, that are separated by virtue of the location of the subarray. Thus, for example, the same unique tags can be reused from bundle to bundle. Thus, the use of 50 unique tags in combination with 100 different subarrays can form an array of 5000 different capture probes. In this embodiment, it becomes important to be able to identify one bundle from another; in general, this is done either manually or through the use of marker beads, i.e. beads containing unique tags for each subarray.

[0225] In alternative embodiments, additional encoding parameters can be added, such as microsphere size. For example, the use of different size beads may also allow the reuse of sets of DBLs; that is, it is possible to use microspheres of different sizes to expand the encoding dimensions of the microspheres. Optical fiber arrays can be fabricated containing pixels with different fiber diameters or cross-sections; alternatively, two or more fiber optic bundles, each with different cross-sections of the individual fibers, can be added together to form a larger bundle; or, fiber optic bundles with fiber of the same size cross-sections can be used, but just with different sized beads. With different diameters, the largest wells can be filled with the largest microspheres and then moving onto progressively smaller microspheres in the smaller

wells until all size wells are then filled. In this manner, the same dye ratio could be used to encode microspheres of different sizes thereby expanding the number of different oligonucleotide sequences or chemical functionalities present in the array. Although outlined for fiber optic substrates, this as well as the other methods outlined herein can be used with other substrates and with other attachment modalities as well.

5 **[0226]** In a preferred embodiment, the coding and decoding is accomplished by sequential loading of the microspheres into the array. As outlined above for spatial coding, in this embodiment, the optical signatures can be "reused". In this embodiment, the library of microspheres each comprising a different capture probe (or the subpopulations each comprise a different capture probe), is divided into a plurality of sublibraries; for example, depending on the size of the desired array and the number of unique tags, 10 sublibraries each comprising roughly 10% of the total library may be made, with each sublibrary comprising roughly the same unique tags. Then, the first sublibrary is added to the fiber optic bundle comprising the wells, and the location of each capture probe is determined, generally through the use of DBLs. The second sublibrary is then added, and the location of each capture probe is again determined. The signal in this case will comprise the signal from the "first" DBL and the "second" DBL; by comparing the two matrices the location of each bead in each sublibrary can be determined. Similarly, adding the third, fourth, etc. sublibraries sequentially will allow the array to be filled.

10 **[0227]** In a preferred embodiment, codes can be "shared" in several ways. In a first embodiment, a single code (i.e. IBL/DBL pair) can be assigned to two or more agents if the target sequences differ sufficiently in their binding strengths. For example, two nucleic acid probes used in an mRNA quantitation assay can share the same code if the ranges of their hybridization signal intensities do not overlap. This can occur, for example, when one of the target sequences is always present at a much higher concentration than the other. Alternatively, the two target sequences might always be present at a similar concentration, but differ in hybridization efficiency.

15 **[0228]** Alternatively, a single code can be assigned to multiple agents if the agents are functionally equivalent. For example, if a set of oligonucleotide probes are designed with the common purpose of detecting the presence of a particular gene, then the probes are functionally equivalent, even though they may differ in sequence. Similarly, an array of this type could be used to detect homologs of known genes. In this embodiment, each gene is represented by a heterologous set of probes, hybridizing to different regions of the gene (and therefore differing in sequence). The set of probes share a common code. If a homolog is present, it might hybridize to some but not all of the probes. The level of homology might be indicated by the fraction of probes hybridizing, as well as the average hybridization intensity. Similarly, multiple antibodies to the same protein could all share the same code.

20 **[0229]** In a preferred embodiment, decoding of self-assembled random arrays is done on the bases of pH titration. In this embodiment, in addition to capture probes, the beads comprise optical signatures, wherein the optical signatures are generated by the use of pH-responsive dyes (sometimes referred to herein as "ph dyes") such as fluorophores. This embodiment is similar to that outlined in PCT US98/05025 and U.S.S.N. 091151,877, both of which are expressly incorporated by reference, except that the dyes used in the present invention exhibit changes in fluorescence intensity (or other properties) when the solution pH is adjusted from below the pKa to above the pKa (or vice versa). In a preferred embodiment, a set of pH dyes are used, each with a different pKa, preferably separated by at least 0.5 pH units. Preferred embodiments utilize a pH dye set of pKa's of 2.0, 2.5, 3.0, 3.5, 4.0, 4.5, 5.0, 5.5, 6.0, 6.5, 7.0, 7.5, 8.0, 8.5, 9.0, 9.5, 10.0, 10.5, 11, and 11.5. Each bead can contain any subset of the pH dyes, and in this way a unique code for the capture probe is generated. Thus, the decoding of an array is achieved by titrating the array from pH 1 to pH 13, and measuring the fluorescence signal from each bead as a function of solution pH.

25 **[0230]** Herein described are arrays compositions comprising a substrate with a surface comprising discrete sites. A population of microspheres is distributed on the sites, and the population comprises at least a first and a second subpopulation. Each subpopulation comprises a capture probe, and, in addition, at least one optical dye with a given pKa. The pKas of the different optical dyes are different.

30 **[0231]** In a preferred embodiment, several levels of redundancy are built into the arrays used in the methods of the invention. Building redundancy into an array gives several significant advantages, including the ability to make quantitative estimates of confidence about the data and significant increases in sensitivity. Thus, preferred embodiments utilize array redundancy. As will be appreciated by those in the art, there are at least two types of redundancy that can be built into an array: the use of multiple identical sensor elements (termed herein "sensor redundancy"), and the use of multiple sensor elements directed to the same target analyte, but comprising different chemical functionalities (termed herein "target redundancy"). For example, for the detection of nucleic acids, sensor redundancy utilizes a plurality of sensor elements such as beads comprising identical binding ligands such as probes. Target redundancy utilizes sensor elements with different probes to the same target: one probe may span the first 25 bases of the target, a second probe may span the second 25 bases of the target, etc. By building in either or both of these types of redundancy into an array, significant benefits are obtained. For example, a variety of statistical mathematical analyses may be done.

35 **[0232]** In addition, while this is generally described herein for bead arrays, as will be appreciated by those in the art, this techniques can be used for any type of arrays designed to detect target analytes.

40 **[0233]** In a preferred embodiment, sensor redundancy is used. In this embodiment, a plurality of sensor elements,

e.g. beads, comprising identical bioactive agents are used. That is, each subpopulation comprises a plurality of beads comprising identical bioactive agents (e.g. binding ligands). By using a number of identical sensor elements for a given array, the optical signal from each sensor element can be combined and any number of statistical analyses run, as outlined below. This can be done for a variety of reasons. For example, in time varying measurements, redundancy can significantly reduce the noise in the system. For non-time based measurements, redundancy can significantly increase the confidence of the data.

[0234] In a preferred embodiment, a plurality of identical sensor elements are used. As will be appreciated by those in the art, the number of identical sensor elements will vary with the application and use of the sensor array. In general, anywhere from 2 to thousands may be used, with from 2 to 100 being preferred, 2 to 50 being particularly preferred and from 5 to 20 being especially preferred. In general, preliminary results indicate that roughly 10 beads gives a sufficient advantage, although for some applications, more identical sensor elements can be used.

[0235] Once obtained, the optical response signals from a plurality of sensor beads within each bead subpopulation can be manipulated and analyzed in a wide variety of ways, including baseline adjustment, averaging, standard deviation analysis, distribution and cluster analysis, confidence interval analysis, mean testing, etc.

[0236] In a preferred embodiment, the first manipulation of the optical response signals is an optional baseline adjustment. In a typical procedure, the standardized optical responses are adjusted to start at a value of 0.0 by subtracting the integer 1.0 from all data points. Doing this allows the baseline-loop data to remain at zero even when summed together and the random response signal noise is canceled out. When the sample is a fluid, the fluid pulse-loop temporal region, however, frequently exhibits a characteristic change in response, either positive, negative or neutral, prior to the sample pulse and often requires a baseline adjustment to overcome noise associated with drift in the first few data points due to charge buildup in the CCD camera. If no drift is present, typically the baseline from the first data point for each bead sensor is subtracted from all the response data for the same bead. If drift is observed, the average baseline from the first ten data points for each bead sensor is subtracted from all the response data for the same bead. By applying this baseline adjustment, when multiple bead responses are added together they can be amplified while the baseline remains at zero. Since all beads respond at the same time to the sample (e.g. the sample pulse), they all see the pulse at the exact same time and there is no registering or adjusting needed for overlaying their responses. In addition, other types of baseline adjustment may be done, depending on the requirements and output of the system used.

[0237] Once the baseline has been adjusted, a number of possible statistical analyses may be run to generate known statistical parameters. Analyses based on redundancy are known and generally described in texts such as Freund and Walpole, *Mathematical Statistics*, Prentice Hall, Inc. New Jersey, 1980, hereby incorporated by reference in its entirety.

[0238] In a preferred embodiment, signal summing is done by simply adding the intensity values of all responses at each time point, generating a new temporal response comprised of the sum of all bead responses. These values can be baseline-adjusted or raw. As for all the analyses described herein, signal summing can be performed in real time or during post-data acquisition data reduction and analysis. In one embodiment, signal summing is performed with a commercial spreadsheet program (Excel, Microsoft, Redmond, WA) after optical response data is collected.

[0239] In a preferred embodiment, cumulative response data is generated by simply adding all data points in successive time intervals. This final column, comprised of the sum of all data points at a particular time interval, may then be compared or plotted with the individual bead responses to determine the extent of signal enhancement or improved signal-to-noise ratios.

[0240] In a preferred embodiment, the mean of the subpopulation (i.e. the plurality of identical beads) is determined, using the well known Equation 1:

Equation 1

$$\mu = \sum \frac{x_i}{n}$$

[0241] In some embodiments, the subpopulation may be redefined to exclude some beads if necessary (for example for obvious outliers, as discussed below).

[0242] In a preferred embodiment, the standard deviation of the subpopulation can be determined, generally using Equation 2 (for the entire subpopulation) and Equation 3 (for less than the entire subpopulation):

Equation 2

$$\sigma = \sqrt{\frac{\sum (x_i - \mu)^2}{n}}$$

Equation 3

$$s = \sqrt{\frac{\sum (x_i - \bar{x})^2}{n - 1}}$$

[0243] As for the mean, the subpopulation may be redefined to exclude some beads if necessary (for example for obvious outliers, as discussed below).

[0244] In a preferred embodiment, statistical analyses are done to evaluate whether a particular data point has statistical validity within a subpopulation by using techniques including, but not limited to, t distribution and cluster analysis. This may be done to statistically discard outliers that may otherwise skew the result and increase the signal-to-noise ratio of any particular experiment. This may be done using Equation 4:

Equation 4

$$t = \frac{\bar{x} - \mu}{s / \sqrt{n}}$$

[0245] In a preferred embodiment, the quality of the data is evaluated using confidence intervals, as is known in the art. Confidence intervals can be used to facilitate more comprehensive data processing to measure the statistical validity of a result.

[0246] In a preferred embodiment, statistical parameters of a subpopulation of beads are used to do hypothesis testing. One application is tests concerning means, also called mean testing. In this application, statistical evaluation is done to determine whether two subpopulations are different. For example, one sample could be compared with another sample for each subpopulation within an array to determine if the variation is statistically significant.

[0247] In addition, mean testing can also be used to differentiate two different assays that share the same code. If the two assays give results that are statistically distinct from each other, then the subpopulations that share a common code can be distinguished from each other on the basis of the assay and the mean test, shown below in Equation 5:

Equation 5

$$z = \frac{\bar{x}_1 - \bar{x}_2}{\sqrt{\frac{\sigma_1^2}{n_1} + \frac{\sigma_2^2}{n_2}}}$$

[0248] Furthermore, analyzing the distribution of individual members of a subpopulation of sensor elements may be done. For example, a subpopulation distribution can be evaluated to determine whether the distribution is binomial, Poisson, hypergeometric, etc.

[0249] In addition to the sensor redundancy, a preferred embodiment utilizes a plurality of sensor elements that are directed to a single target analyte but yet are not identical. For example, a single target nucleic acid analyte may have two or more sensor elements each comprising a different probe. This adds a level of confidence as non-specific binding interactions can be statistically minimized. When nucleic acid target analytes are to be evaluated, the redundant nucleic acid probes may be overlapping, adjacent, or spatially separated. However, it is preferred that two probes do not compete

for a single binding site, so adjacent or separated probes are preferred. Similarly, when proteinaceous target analytes are to be evaluated, preferred embodiments utilize bioactive agent binding agents that bind to different parts of the target. For example, when antibodies (or antibody fragments) are used as bioactive agents for the binding of target proteins, preferred embodiments utilize antibodies to different epitopes.

[0250] In this embodiment, a plurality of different sensor elements may be used, with from about 2 to about 20 being preferred, and from about 2 to about 10 being especially preferred, and from 2 to about 5 being particularly preferred, including 2, 3, 4 or 5. However, as above, more may also be used, depending on the application.

[0251] As above, any number of statistical analyses may be run on the data from target redundant sensors.

[0252] One benefit of the sensor element summing (referred to herein as "bead summing" when beads are used), is the increase in sensitivity that can occur.

Examples

Attachment of genomic DNA to a solid support

1. Fragmentation of Genomic DNA

[0253]

Human Genomic DNA	10 mg (100 μ l)
10X DNase I Buffer	12.5 μ l
DNase I (1 U/ μ l, BRL)	0.5 μ l
ddH ₂ O	12 μ l

[0254] Incubate 37°C for 10 min. Add 1.25 μ l 0.5 M EDTA, Heat at 99°C for 15 min.

2. Precipitation of fragmented genomic DNA

[0255]

DNase I fragmented genomic DNA	125 μ l
Quick-Precip Plus Solution (Edge Biosystems)	20 μ l
Cold 100% EtOH	300 μ l

[0256] Store at -20°C for 20 min. Spin at 12,500 rpm for 5 min. Wash pellet 2x with 70% EtOH, and air dry.

3. Terminal Transferase End-Labeling with Biotin

[0257]

DNase I fragmented and precipitated genomic DNA (in H ₂ O)	77.3 μ l
5X Terminal transferase buffer	20 μ l
Biotin-N6-ddATP (1 mM, NEN)	1 μ l
Terminal transferase (15 U/ μ l)	1.7 μ l

[0258] 37°C for 60 min. Add 1 μ l 0.5 M EDTA, then heat at 99°C for 15 min

4. Precipitation of Biotin-labeled genomic DNA

[0259]

Biotin-labeled genomic DNA	100 μ l
Quick-Precip Solution	20 μ l
EtOH.	250 μ l

EP 1 259 643 B1

[0260] -20°C for 20 min and spin at 12,500 rpm for 5 min, wash 2x with 70% EtOH and air dry.

5. Immobilization of Biotin-labeled Genomic DNA to Streptavidin-coated PCR tubes

5 [0261] Heat-denature genomic DNA for 10 min on 95°C heat block.

	Biotin-labeled genomic DNA (0.3 µg/ µl)	3 µl
	2 x binding buffer	25 µl
	SNP Primers (50 nM)	10 µl
10	ddH2O	12 µl

[0262] Incubate at 60°C for 60 min.

15 Wash 1x with 1 X binding buffer,
1X with 1 X washing buffer,
1X with 1 X ligation buffer.

20 [0263] 1X binding buffer: 20 mM Tris-HCl, pH7.5, 0.5M NaCl, 1 mM EDTA, 0.1% SDS.

[0264] 1X washing buffer: 20mM Tris-HCl pH7.5, 0.1 M NaCl, 1 mM EDTA, 0.1% Triton X-100.

[0265] 1X ligation buffer: 20 mM Tris-HCl pH7.6, 25 mM Potassium acetate, 10 mM magnesium acetate, 10 mM DTT, 1 mM NAD, 0.1% Triton X-100.

25 6. Ligation In Streptavidin-coated PCR tubes

[0266]

30 make a master solution and each tube contains 49 µl 1X ligation buffer
1 µl Taq DNA Ligase (40 U/ µl)

incubate at 60°C for 60 min.

35 wash each tube 1x with 1X washing buffer
1x with ddH2O

7. Elution of ligated products

40 [0267] add 50 µl ddH2O to each tube and incubated at 95°C for 5 min, chilled on ice, transfer the supernatant to a clean tube.

8. PCR set up

45 [0268]

	25 mM dNTPs	0.5 µl
	10X buffer II (PEB)	2.5 µl
	25mM MgCl2	1.5 µl
50	AmpliTaq Gold DNA Polymerase (5 Units/µl, PEB)	0.3 µl
	Eluted (ligated) product (see above)	3 µl
	Primer set (T3/T7/T7v, 10 µM each)	2 µl
	ddH2O	1 µl
55	Total volume	25 µl

PCR condition:

[0269]

5 94°C 10 min
 35 cycles of 94°C 30 sec
 60°C 30 sec
 10 and then
 72°C 30 sec

15 **Claims**

1. A method of determining the identification of nucleotides at detection positions in target sequences comprising:

20 a) providing a plurality of probe sets, wherein each set comprises:

- i) a first ligation probe comprising an upstream universal priming site and a first target-specific sequence; and
- ii) a second ligation probe comprising a downstream universal priming site and a second target-specific sequence;

25 wherein either the first or second target-specific sequence comprises a base at an interrogation position, and wherein at least one of said first and second ligation probes comprises an adapter sequence complementary to a capture probe on an array;

30 b) hybridizing said plurality of probe sets to target sequences immobilized on a support or supports, said target sequences each comprising a first target domain comprising a detection position and a second target domain adjacent to said detection position, wherein a first ligation probe comprising a sequence specific for the target hybridizes to the first target domain and a second ligation probe comprising a sequence specific for the target hybridizes to the second target domain, and wherein if said base at said interrogation position is perfectly complementary to a nucleotide at said detection position, a ligation complex is formed;

- c) providing a ligase that ligates said first and second ligation probes to form ligated probes;
- d) amplifying said ligated probes to generate a plurality of amplicons;
- e) contacting said amplicons with an array comprising capture probes on a solid support; and
- f) determining the nucleotide at each of said detection positions.

40 2. The method of claim 1, wherein the amplicons comprise a label.

3. The method of claim 2, wherein the label comprises a fluorescent label.

45 4. The method of any one of the preceding claims, wherein the first and second target domain are separated by one or more nucleotides and wherein the method comprises adding dNTPs and a polymerase prior to providing the ligase to form the ligated probe.

5. The method of any one of the preceding claims, wherein the target sequences are genomic DNA.

50 **Patentansprüche**

1. Verfahren zur Bestimmung der Identität von Nucleotiden an Detektionspositionen in Zielsequenzen, umfassend:

55 a) das Bereitstellen mehrerer Sondensets, worin jedes Set Folgendes umfasst:

- i) eine erste Ligationssonde, eine stromauf liegende Universalprimerstelle und eine erste zielspezifische Sequenz umfassend; und

ii) eine zweite Ligationssonde, eine stromab liegende Universalprimerstelle und eine zweite zielspezifische Sequenz umfassend;

worin entweder die erste oder die zweite zielspezifische Sequenz eine Base an einer Abfrageposition umfasst und worin zumindest eine aus der ersten und der zweiten Ligationssonde eine Adaptersequenz, die komplementär zu einer Fangsonde ist, auf einem Array umfasst;

b) das Hybridisieren der mehreren Sondensets an Zielsequenzen, die auf einem oder mehreren Trägern immobilisiert sind, wobei die Zielsequenzen jeweils eine erste Zieldomäne, die eine Detektionsposition umfasst, und eine zweite Zieldomäne, die zur Detektionsposition benachbart ist, umfassen, worin eine erste Ligationssonde, die eine für das Ziel spezifische Sequenz umfasst, an die erste Zieldomäne hybridisiert und eine zweite Ligationssonde, die eine für das Ziel spezifische Sequenz umfasst, an die zweite Zieldomäne hybridisiert und worin, wenn die Base an der Abfrageposition völlig komplementär zu einem Nucleotid an der Detektionsposition ist, ein Ligationskomplex gebildet wird;

c) das Bereitstellen einer Ligase, welche die erste und zweite Ligationssonde ligiert, um ligierte Sonden zu bilden;

d) das Amplifizieren der ligierten Sonden, um mehrere Amplicons zu erzeugen;

e) das Kontaktieren der Amplicons mit einem Array, das Fangsonden auf einem festen Träger umfasst;

f) das Bestimmen des Nucleotids an jeder der Detektionspositionen.

2. Verfahren nach Anspruch 1, worin die Amplicons eine Markierung umfassen.

3. Verfahren nach Anspruch 2, worin die Markierung eine fluoreszierende Markierung umfasst.

4. Verfahren nach einem der vorangegangenen Ansprüche, worin die erste und zweite Zieldomäne durch ein oder mehrere Nucleotide getrennt sind und worin das Verfahren das Hinzufügen von dNTPs und einer Polymerase vor der Bereitstellung der Ligase zur Bildung der ligierten Sonde umfasst.

5. Verfahren nach einem der vorangegangenen Ansprüche, worin die Zielsequenzen genomische DNA sind.

Revendications

1. Méthode de détermination de l'identification de nucléotides en des positions de détection dans des séquences cibles consistant à:

a) prévoir un certain nombre de groupes de sondes, où chaque groupe comprend:

i) une première sonde de ligature comprenant un site d'amorce universelle en amont et une première séquence spécifique de la cible; et

ii) une seconde sonde de ligature comprenant un site d'amorce universelle en aval et une seconde séquence spécifique de la cible;

où la première ou la seconde séquence spécifique de la cible comprend une base en une position d'interrogation et où au moins l'une desdites première et seconde sondes de ligature comprend une séquence d'adaptation complémentaire d'une sonde de capture sur une série;

b) hybrider ladite quantité de groupes de sondes à des séquences cibles immobilisées sur un support ou des supports, lesdites séquences cibles comprenant chacune un premier domaine de cible comprenant une position de détection et un second domaine de cible adjacent à ladite position de détection, où une première sonde de ligature comprenant une séquence spécifique de la cible s'hybride au premier domaine de la cible et une seconde sonde de ligature comprenant une séquence spécifique de la cible s'hybride au second domaine de la cible et où si ladite base à ladite position d'interrogation est parfaitement complémentaire d'un nucléotide à ladite position de détection, un complexe de ligature se forme;

c) prévoir une ligase qui lie lesdites première et seconde sondes de ligature pour former des sondes ligaturées;

d) amplifier lesdites sondes ligaturées pour générer un certain nombre d'amplicons;

e) mettre lesdits amplicons en contact avec une série comprenant des sondes de capture sur un support solide; et

f) déterminer le nucléotide à chacune desdites positions de détection.

2. Méthode de la revendication 1, où les amplicons comprennent un marqueur.

EP 1 259 643 B1

3. Méthode de la revendication 2, où le marqueur comprend un marqueur fluorescent.
4. Méthode de l'une quelconque des revendications précédentes, où les premier et second domaines de la cible sont séparés par un ou plusieurs nucléotides et où la méthode comprend l'addition de dNTP et d'une polymérase avant de produire la ligase pour former la sonde ligaturée.
5. Méthode de l'une quelconque des revendications précédentes, où les séquences de la cible sont de l'ADN génomique.

5

10

15

20

25

30

35

40

45

50

55

A Flow Chart for Array-based Detection of Gene Expression

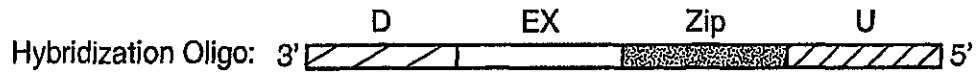

- U: Upstream universal priming site
- Zip: Unique sequence as a molecular "zip-code"
- EX: Gene-specific exon sequence
- D: Downstream universal priming site

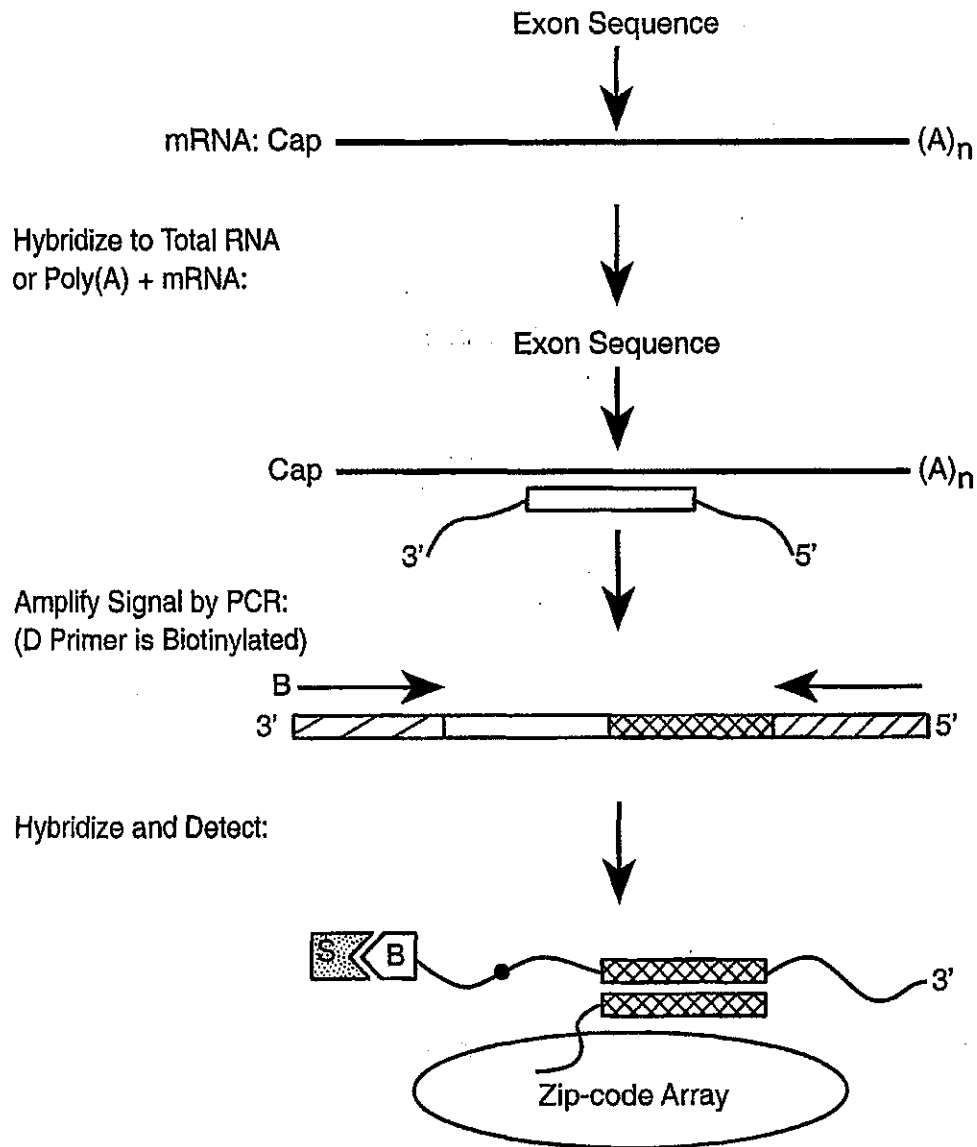
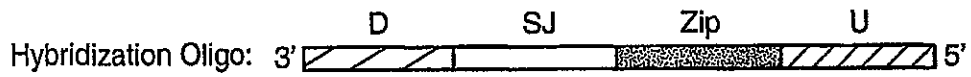

FIG. 1

A Flow Chart for Array-based Detection of RNA Alternative Splicing



- U: Upstream universal priming site
- Zip: Unique sequence as a molecular "zip-code"
- SJ: Gene-specific splice junction
- D: Downstream universal priming site

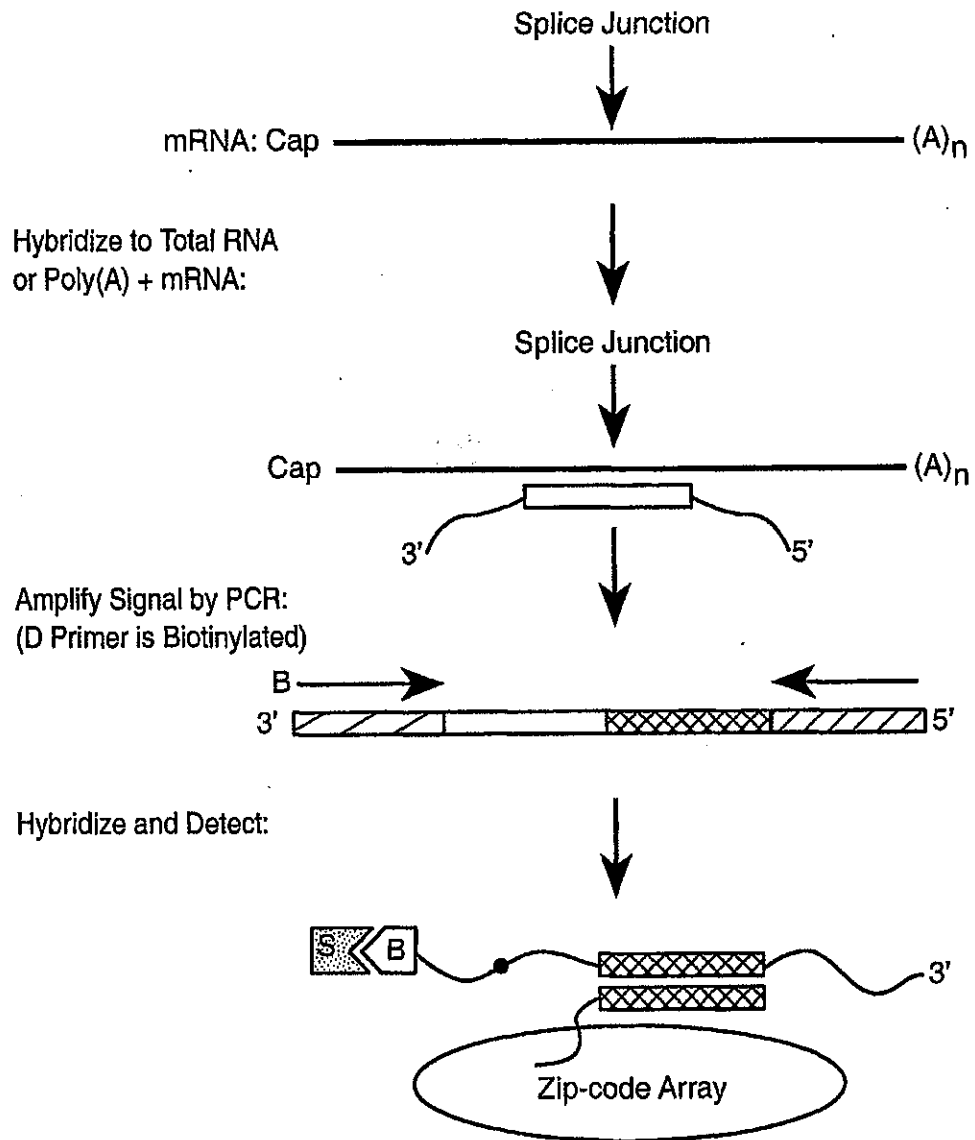
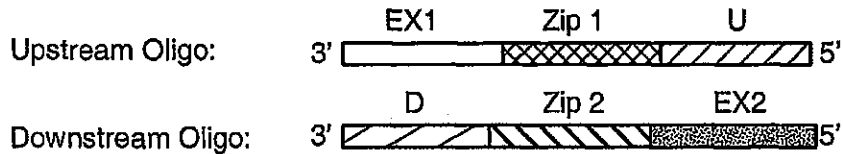

FIG. 2

Genome-wide Gene Expression Profiling Using Oligo-ligation Strategy



- U: Upstream universal priming site
- Zip 1: Unique sequence as a molecular "zip-code"
- Zip 2: A different zip-code
- EX1: Gene-specific exon sequence
- EX2: Gene-specific exon sequence
- D: Downstream universal priming site

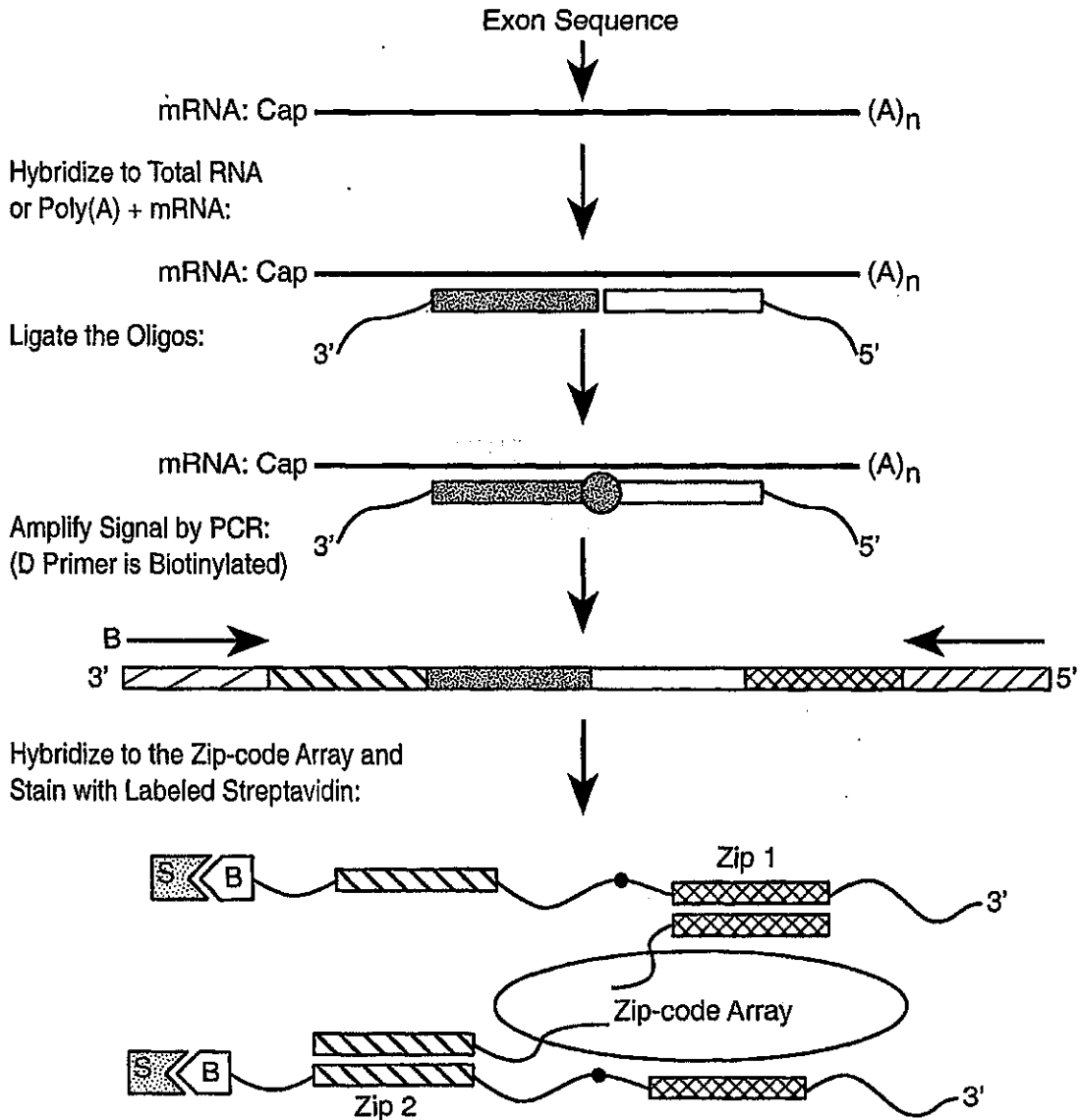
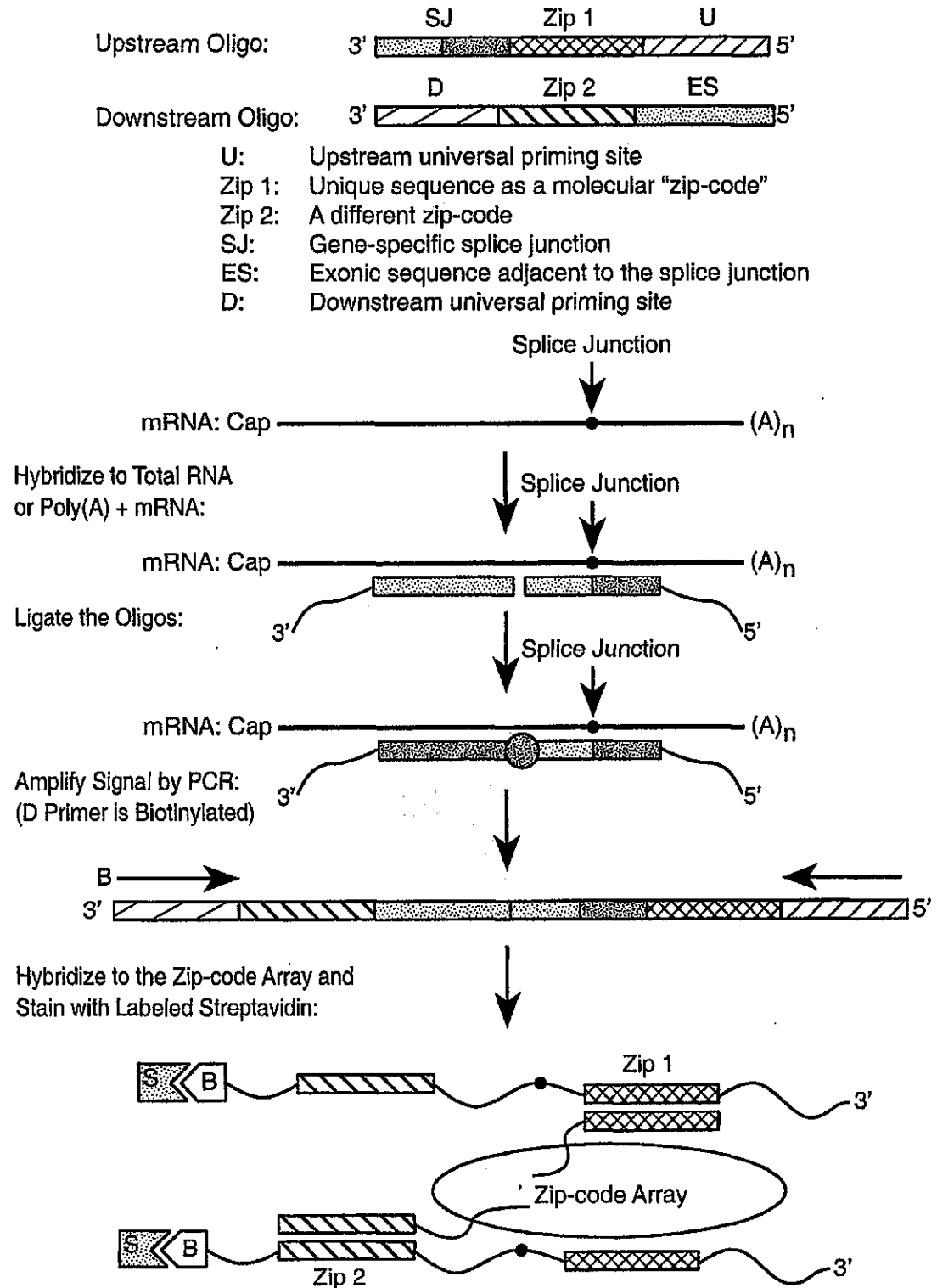



FIG. 3

Genome-wide RNA Alternative Splicing Monitoring Using Oligo-Ligation Strategy



Direct Genotyping Using a Whole-genome Oligo-ligation Strategy

Upstream Oligo: 3'  5'

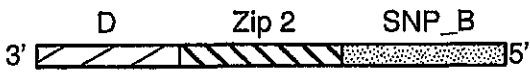
Downstream Oligo: 3'  5'

- U: Upstream universal priming site
- Zip 1: Unique sequence as a molecular "zip-code"
- Zip 2: A different zip-code
- SNP_A: SNP-specific sequence
- SNP_B: SNP-specific sequence
- D: Downstream universal priming site

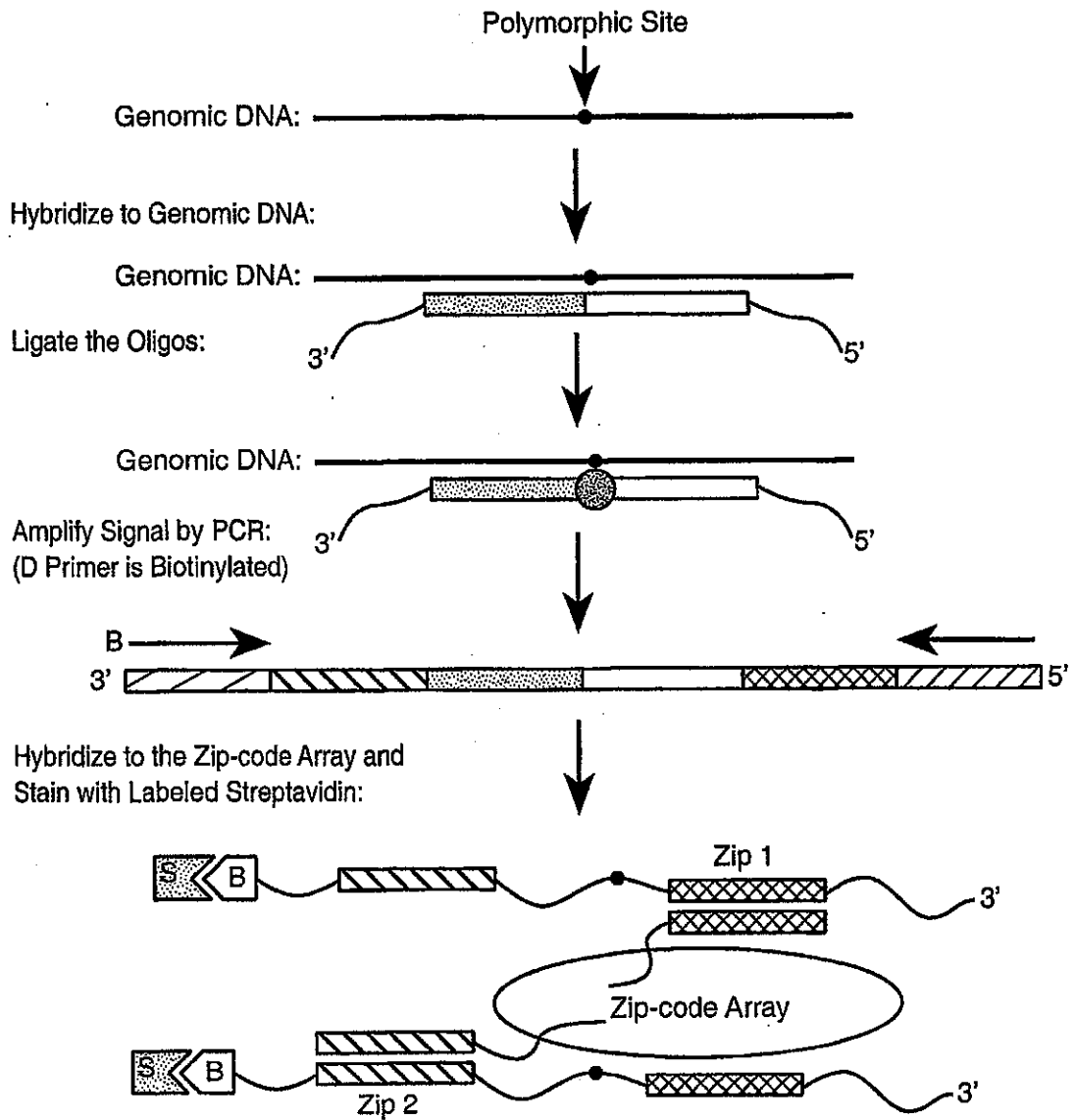

FIG. 5

Whole-genome Oligo-ligation Strategy

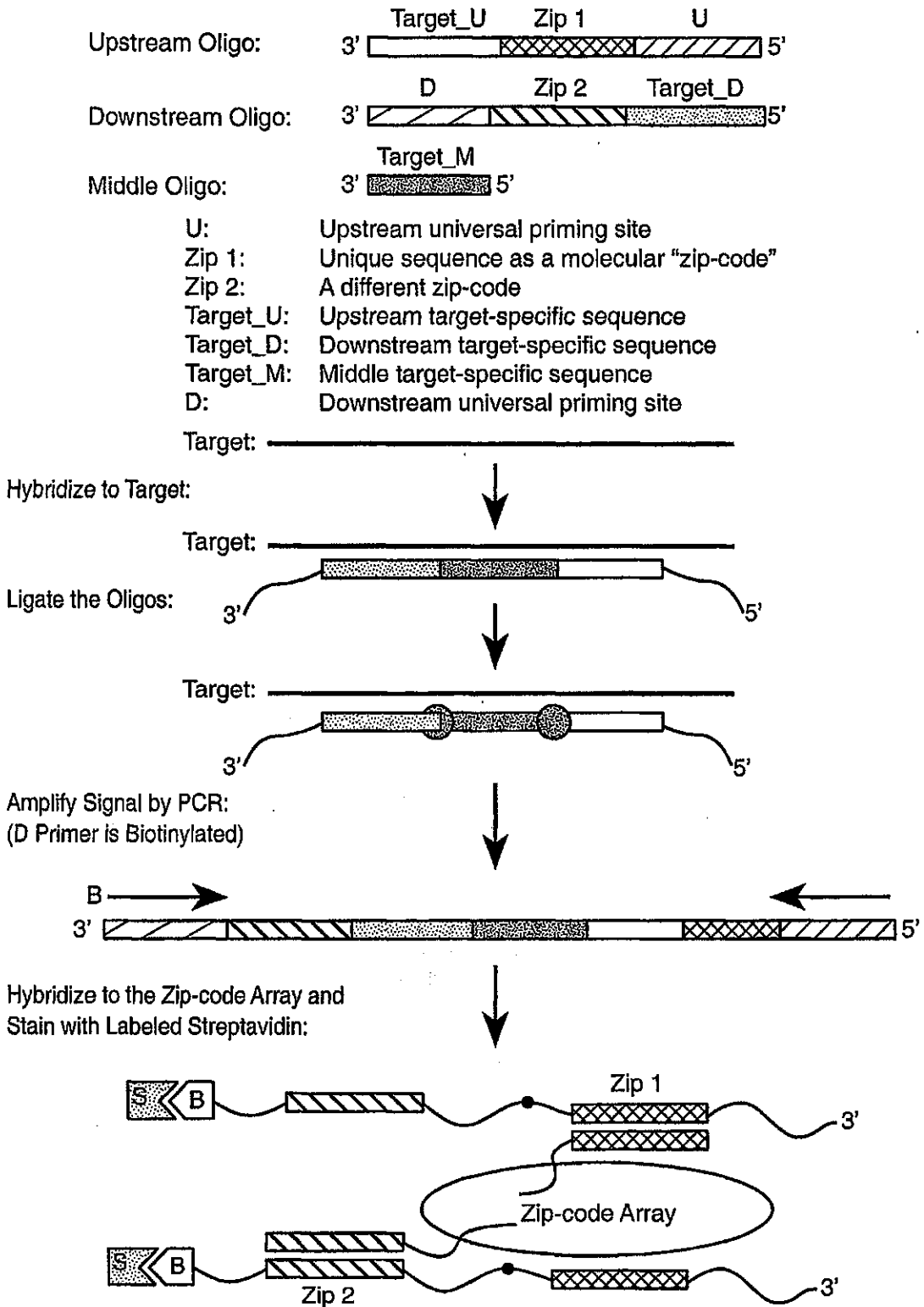

FIG. 6

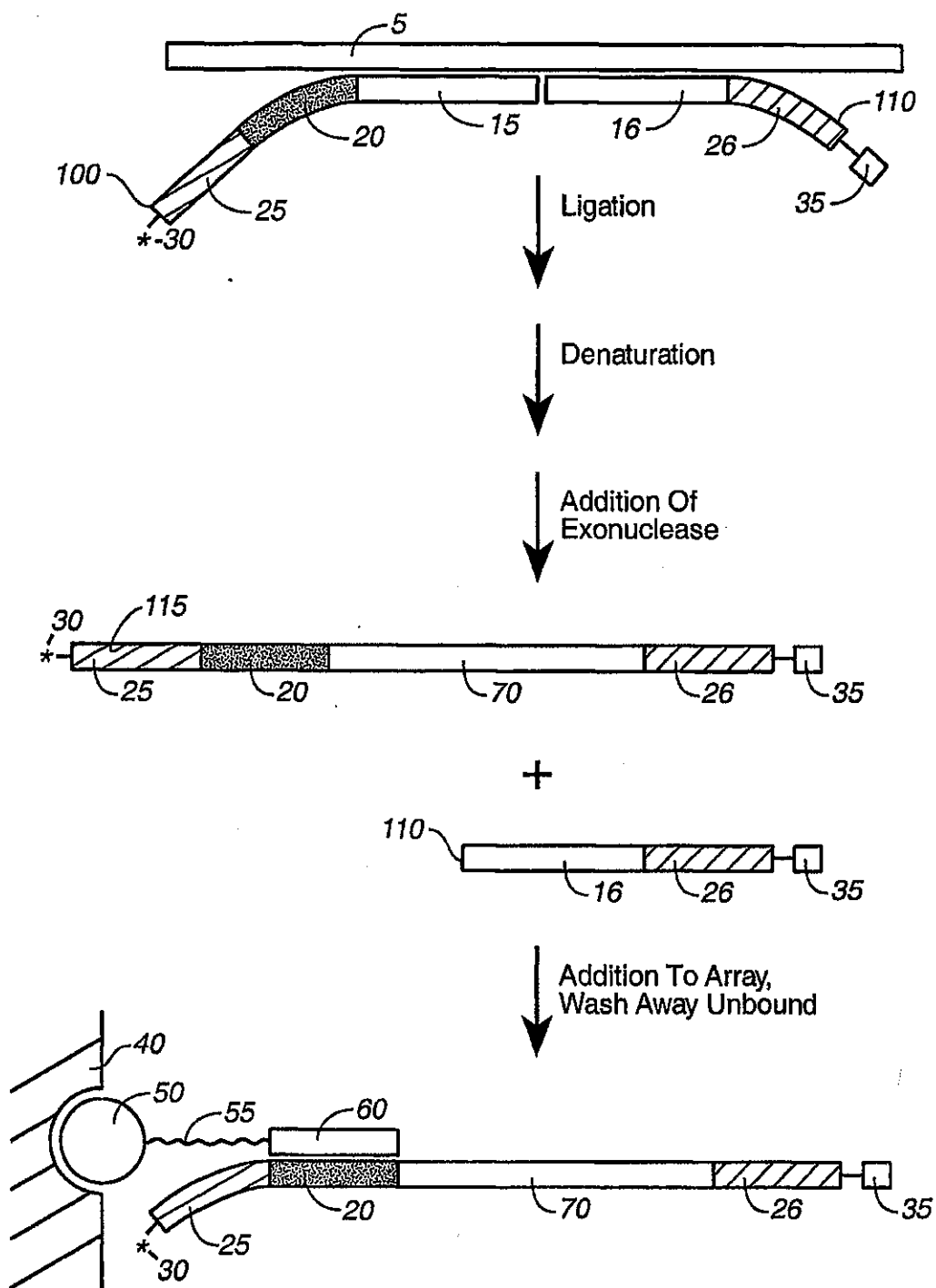

FIG. 8

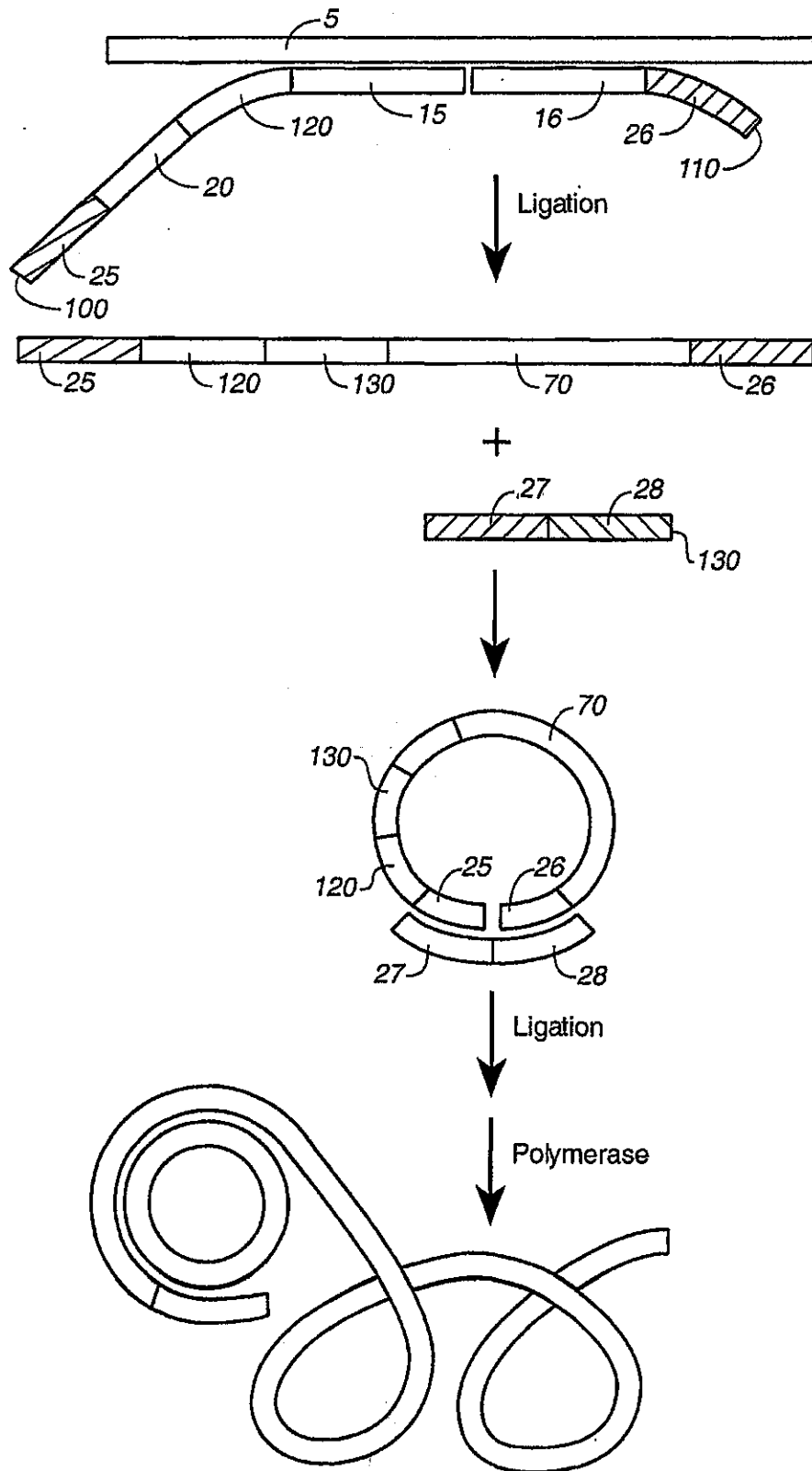

FIG._9

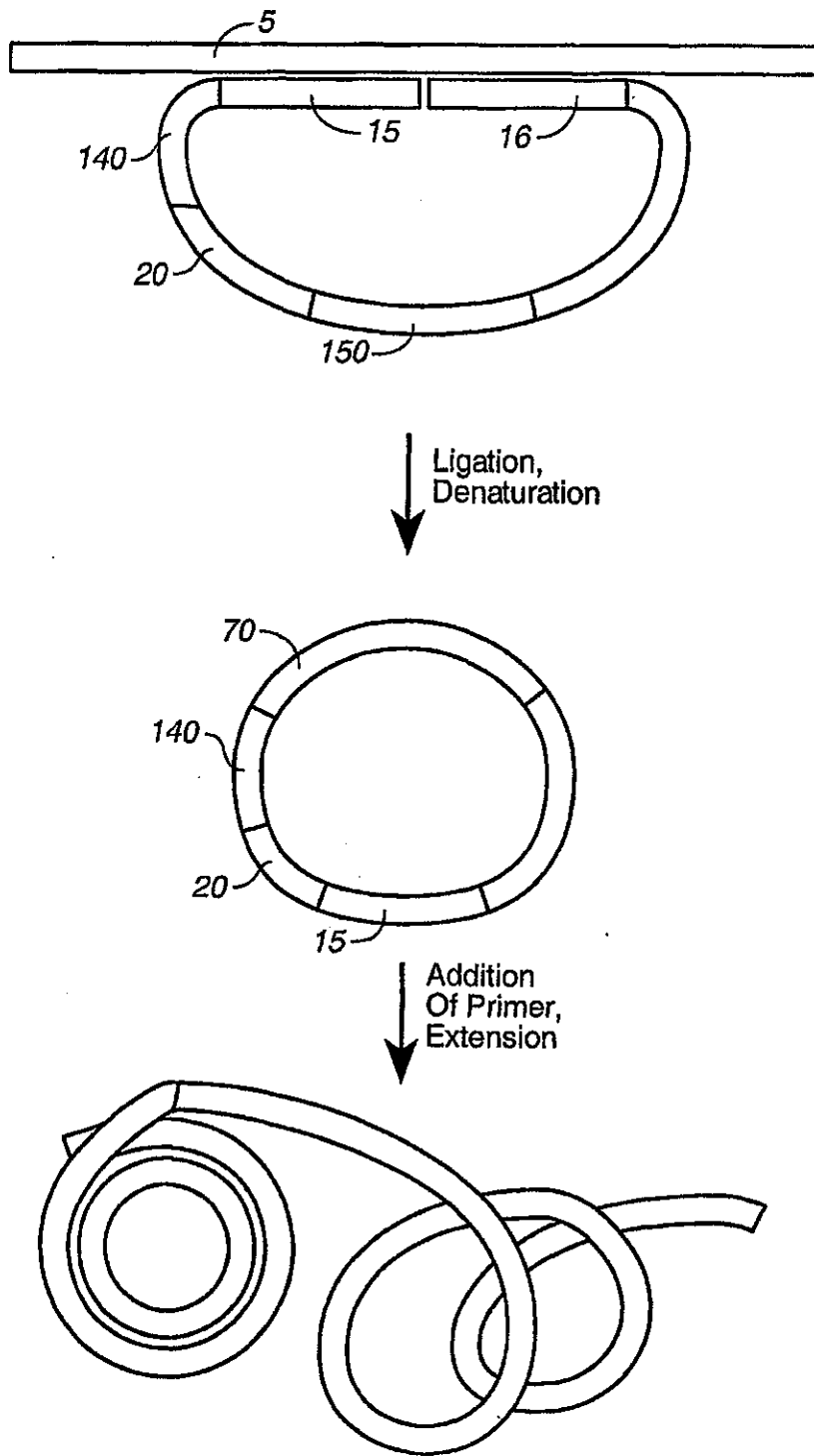

FIG. 10

REFERENCES CITED IN THE DESCRIPTION

This list of references cited by the applicant is for the reader's convenience only. It does not form part of the European patent document. Even though great care has been taken in compiling the references, errors or omissions cannot be excluded and the EPO disclaims all liability in this regard.

Patent documents cited in the description

- WO 9615271 A [0006]
- WO 9745559 A [0006]
- US 5644048 A [0020]
- US 5386023 A [0020]
- US 5637684 A [0020]
- US 5602240 A [0020]
- US 5216141 A [0020]
- US 4469863 A [0020]
- US 5235033 A [0020]
- US 5034506 A [0020]
- US 5681702 A [0023]
- US 5681697 A [0032]
- US 5185243 A [0054]
- US 5573907 A [0054]
- EP 0320308 B1 [0054]
- EP 0336731 B1 [0054]
- EP 0439182 B1 [0054]
- WO 9001069 A [0054]
- WO 8912696 A [0054]
- WO 8909835 A [0054]
- US 4683195 A [0079]
- US 4683202 A [0079]
- US SN09315584 A [0101]
- WO 0063437 A [0109] [0143]
- US 5846717 A [0138]
- US 5614402 A [0138]
- US 5719029 A [0138]
- US 5541311 A [0138]
- US 5843669 A [0138]
- US 9821193 W [0145]
- US 9914387 W [0145]
- US 9805025 W [0145] [0150] [0229]
- WO 9850782 A [0145]
- US SNS09287573 A [0145]
- US 09151877 B [0145] [0186]
- US 09256943 B [0145]
- US 09316154 B [0145]
- US 60119323 B [0145]
- US 09315584 B [0145]
- US SNS08944850 A [0150]
- US 08519062 B [0150]
- US 9809163 W [0150]
- US SN09473904 A [0151]
- US 5270163 A [0179]
- US 5475096 A [0179]
- US 5567588 A [0179]
- US 5595877 A [0179]
- US 5637459 A [0179]
- US 5683867 A [0179]
- US 5705337 A [0179]
- US SNS08818199 A [0186]
- US SN091151877 A [0229]

Non-patent literature cited in the description

- NICKERSON. *Current Opinion in Biotechnology*, 1993, vol. 4, 48-51 [0003]
- ABRAMSON et al. *Current Opinion in Biotechnology*, 1993, vol. 4, 41-47 [0003]
- CORDOR et al. *Science*, 1993, vol. 261 [0007]
- WANG et al. *Science*, 1998, vol. 280, 1077 [0007]
- SCHAFER et al. *Nature Biotechnology*, 1998, vol. 16, 33-39 [0007]
- BEAUCAGE et al. *Tetrahedron*, 1993, vol. 49 (10), 1925 [0020]
- LETSINGER. *J. Org. Chem.*, 1970, vol. 35, 3800 [0020]
- SPRINZL et al. *Eur. J. Biochem.*, 1977, vol. 81, 579 [0020]
- LETSINGER et al. *Nucl. Acids Res.*, 1986, vol. 14, 3487 [0020]
- SAWAI et al. *Chem. Lett.*, 1984, vol. 805 [0020]
- LETSINGER et al. *J. Am. Chem. Soc.*, 1988, vol. 110, 4470 [0020] [0020]
- PAUWELS et al. *Chemica Scripta*, 1986, vol. 26, 141 [0020]
- MAG et al. *Nucleic Acids Res.*, 1991, vol. 19, 1437 [0020]
- BRIU et al. *J. Am. Chem. Soc.*, 1989, vol. 111, 2321 [0020]
- ECKSTEIN. *Oligonucleotides and Analogues: A Practical Approach*. Oxford University Press [0020]
- EGHOLM. *J. Am. Chem. Soc.*, 1992, vol. 114, 1895 [0020]
- MEIER et al. *Chem. Int. Ed. Engl.*, 1992, vol. 31, 1008 [0020]
- NIELSEN. *Nature*, 1993, vol. 365, 566 [0020]
- CARISSON et al. *Nature*, 1996, vol. 380, 207 [0020]
- DENPCY et al. *Proc. Natl. Acad. Sci. USA*, 1995, vol. 92, 6097 [0020]
- KIEDROWSKI et al. *Angew. Chem. Intl. Ed. English*, 1991, vol. 30, 423 [0020]

EP 1 259 643 B1

- **LETSINGER et al.** *Nucleoside & Nucleotide*, 1994, vol. 13, 1597 [0020]
- Carbohydrate Modifications in Antisense Research. ASC Symposium Series 580 [0020] [0020]
- **MESMAEKER et al.** *Bioorganic & Medicinal Chem. Lett.*, 1994, vol. 4, 395 [0020]
- **JEFFS et al.** *J. Biomolecular NMR*, 1994, vol. 34, 17 [0020]
- *Tetrahedron Lett.*, 1996, vol. 37, 743 [0020]
- **JENKINS et al.** *Chem. Soc. Rev.*, 1995, 169-176 [0020]
- *Rawls, C & E News*, 02 June 1997, 35 [0020]
- **MANIATIS et al.** *Molecular Cloning: A Laboratory Manual*. 1989 [0030] [0049]
- **TIJSSEN.** Overview of principles of hybridization and the strategy of nucleic acid assays. *Techniques in Biochemistry and Molecular Biology-Hybridization with Nucleic Acid Probes*, 1993 [0030] [0049]
- Short Protocols in Molecular Biology [0049]
- PCR Essential Data. Wiley & sons, 1995 [0079]
- **BANER et al.** *Nuc. Acids Res.*, 1998, vol. 26, 5073-5078 [0084]
- **BARANY, F.** *Proc. Natl. Acad. Sci. USA*, 1991, vol. 88, 189-193 [0084]
- **LIZARDI.** *Nat. Genet.*, 1998, vol. 19, 225-232 [0084]
- **RICHARD P. HAUGLAND.** *Molecular Probes Handbook* [0101]
- **HERMANSON.** *Bioconjugate Techniques*, San Diego. Academic Press, 640-643 [0112]
- **ASLAM et al.** *Bioconjugation: Protein Coupling Techniques for Biomedical Sciences*. Grove's Dictionaries, 833 [0114]
- **WHITCOMBE et al.** *Nature Biotechnology*, 1999, vol. 17, 804 [0123]