



US00D485308S

(12) **United States Design Patent** (10) **Patent No.:** **US D485,308 S**  
**DeLuca et al.** (45) **Date of Patent:** **\*\* Jan. 13, 2004**

- (54) **INK BOTTLE**
- (75) Inventors: **Donald A. DeLuca**, Guilford, CT (US);  
**Michael Kent**, Cheshire, CT (US);  
**John N. Mitra**, Monroe, CT (US)
- (73) Assignee: **BIC Corp.**, Milford, CT (US)
- (\*\*) Term: **14 Years**
- (21) Appl. No.: **29/150,225**
- (22) Filed: **Nov. 15, 2001**

5,641,078 A \* 6/1997 Kaufmann ..... 211/69.4  
 D388,708 S \* 1/1998 Monaghan ..... D9/523  
 D453,028 S \* 1/2002 DeLuca et al. .... D19/93

\* cited by examiner

*Primary Examiner*—Martie K. Holtje  
 (74) *Attorney, Agent, or Firm*—Pennie & Edmonds LLP

(57) **CLAIM**

The ornamental design for an ink bottle, as shown and described.

**DESCRIPTION**

FIG. 1 is a perspective view of an ink bottle showing our new design;  
 FIG. 2 is a top plan view thereof;  
 FIG. 3 is a bottom plan view thereof;  
 FIG. 4 is a left side elevational view thereof;  
 FIG. 5 is a right side elevational view thereof;  
 FIG. 6 is a front elevational view thereof;  
 FIG. 7 is a rear elevational view thereof;  
 FIG. 8 is a perspective view of a translucent ink bottle showing a second embodiment of our design of FIG. 1;  
 FIG. 9 is a top plan view thereof;  
 FIG. 10 is a bottom plan view thereof;  
 FIG. 11 is a left side elevational view thereof;  
 FIG. 12 is a right side elevational view thereof;  
 FIG. 13 is a front elevational view thereof; and,  
 FIG. 14 is a rear elevational view thereof.  
 All portions shown in broken lines are for illustrative purposes only and form no part of the claimed design.

**Related U.S. Application Data**

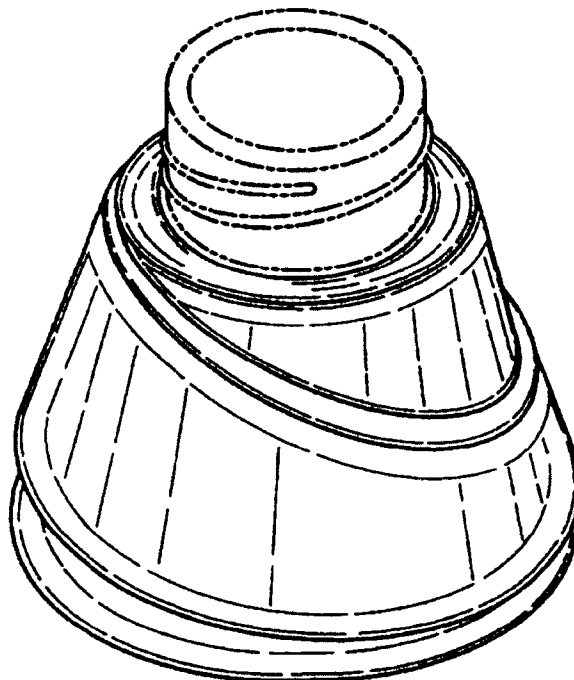
- (63) Continuation-in-part of application No. 29/132,740, filed on Nov. 14, 2000, now Pat. No. Des. 453,028.
- (51) **LOC (7) Cl.** ..... **19-06**
- (52) **U.S. Cl.** ..... **D19/93; D19/95**
- (58) **Field of Search** ..... D19/35, 36, 65,  
D19/75, 79, 81-85, 93, 94, 95, 96, 99,  
100; D9/453, 516, 523, 549, 559; 141/112;  
215/382, 383; 222/588, 589; 248/688; 211/50,  
69.1-69.9

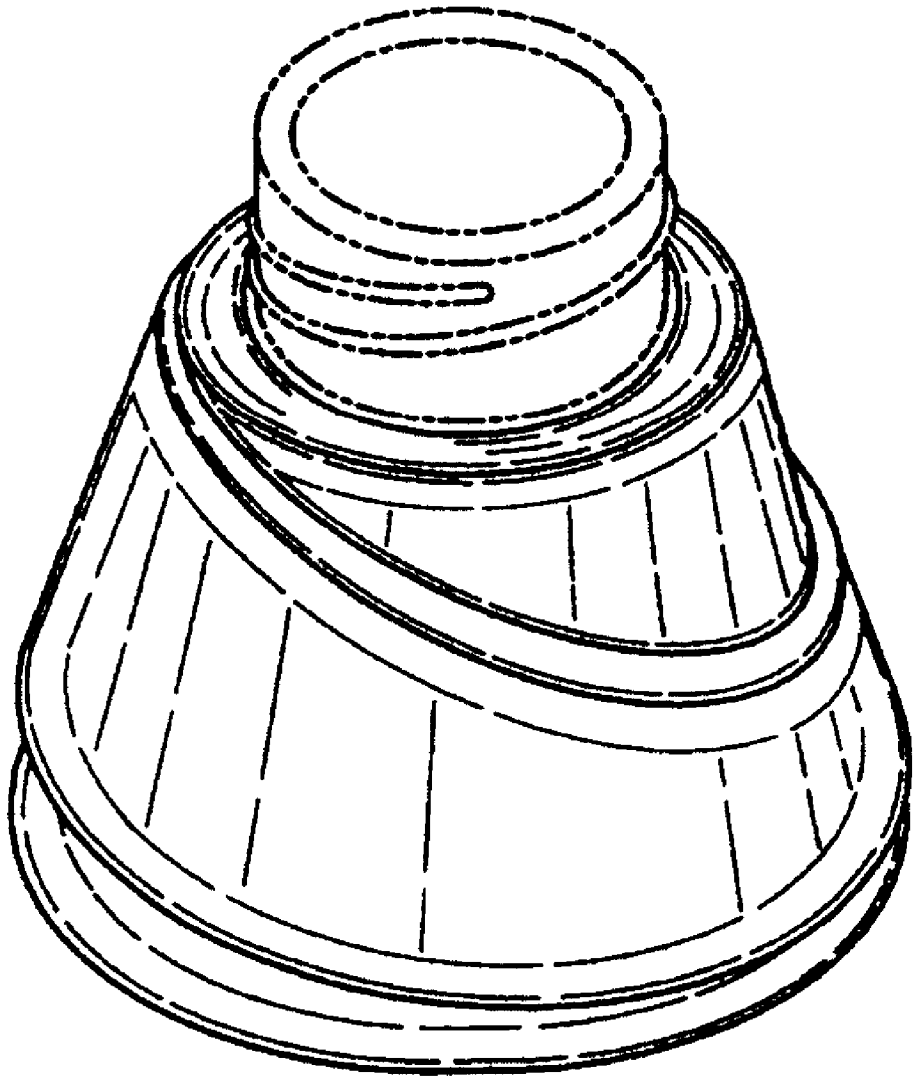
(56) **References Cited**

**U.S. PATENT DOCUMENTS**

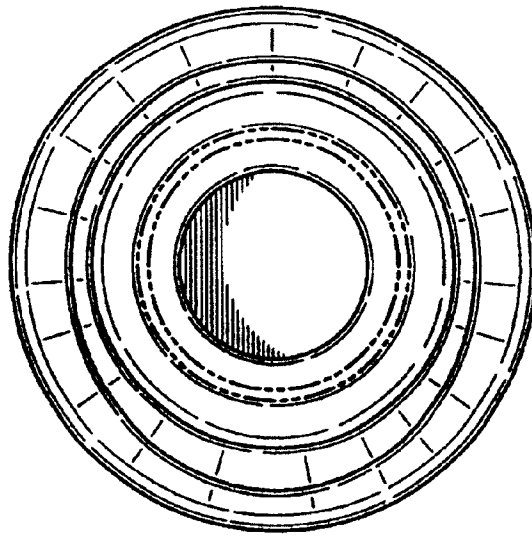
- 1,380,129 A \* 5/1921 Wolff ..... 248/688
- 2,379,588 A \* 7/1945 Morris ..... 211/50
- D170,828 S \* 11/1953 Morris et al. .... D19/93
- D211,561 S \* 7/1968 Pizzuro ..... D9/529
- D332,920 S \* 2/1993 Tiramani et al. .... D9/552
- 5,482,191 A \* 1/1996 Kaufmann ..... 222/577

**1 Claim, 8 Drawing Sheets**

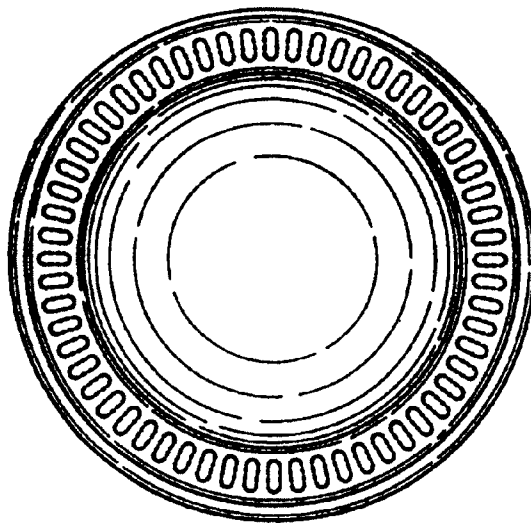




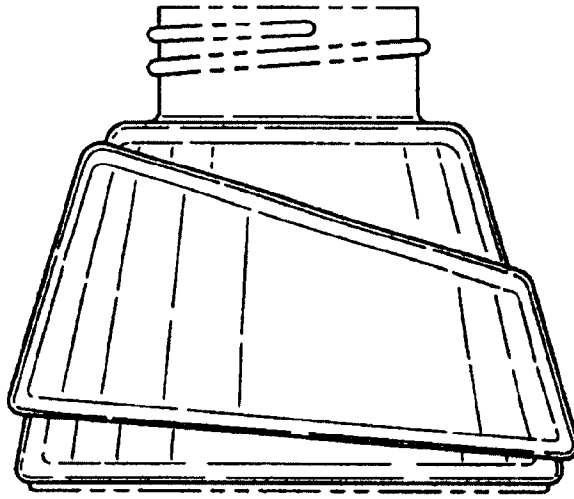
*Fig. 1*



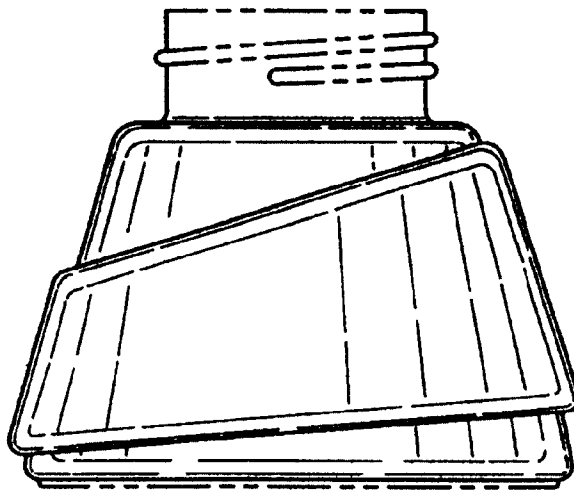
*Fig. 2*



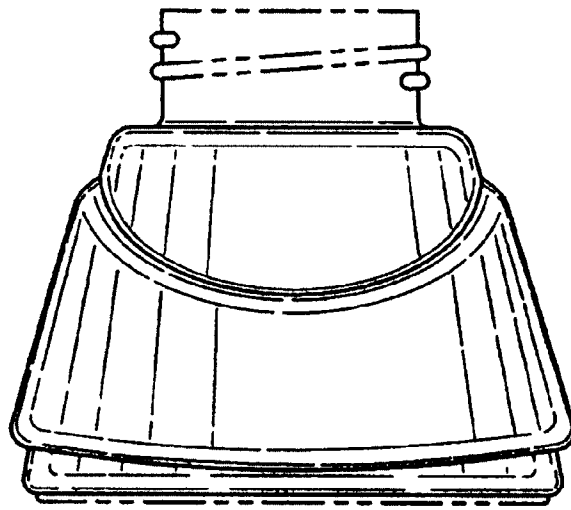
*Fig. 3*



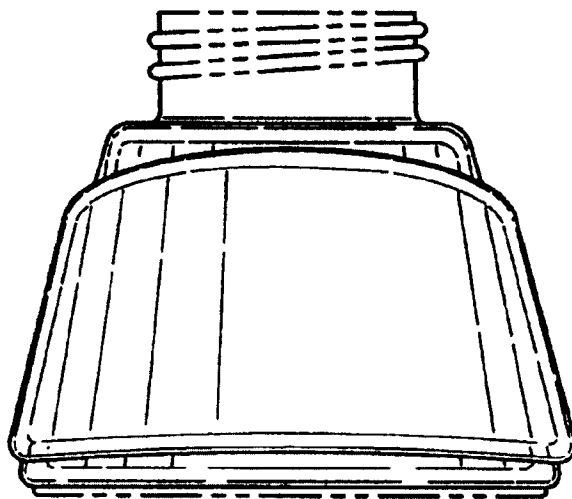
*Fig. 4*



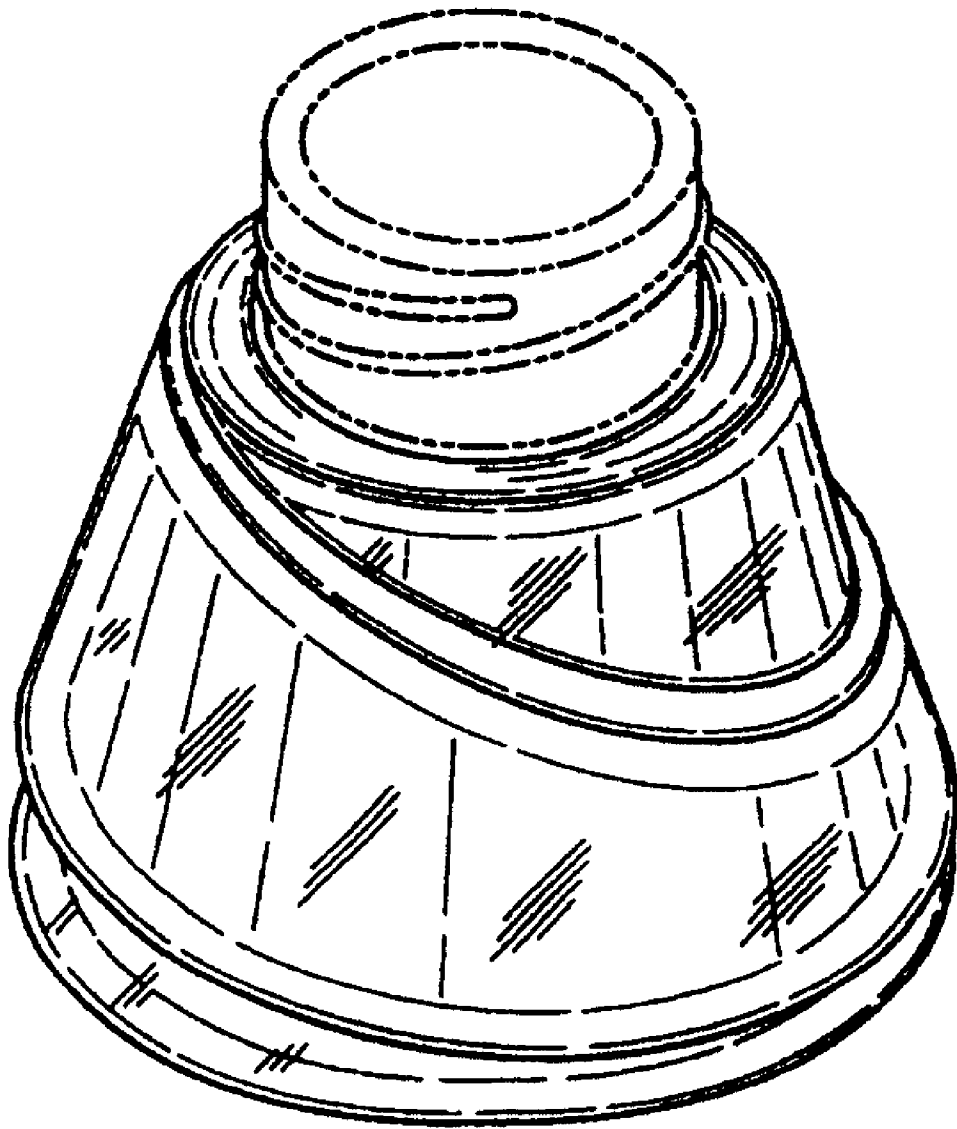
*Fig. 5*



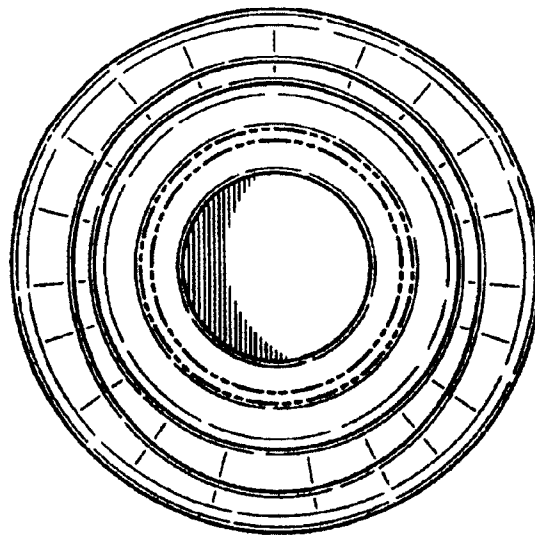
*Fig. 6*



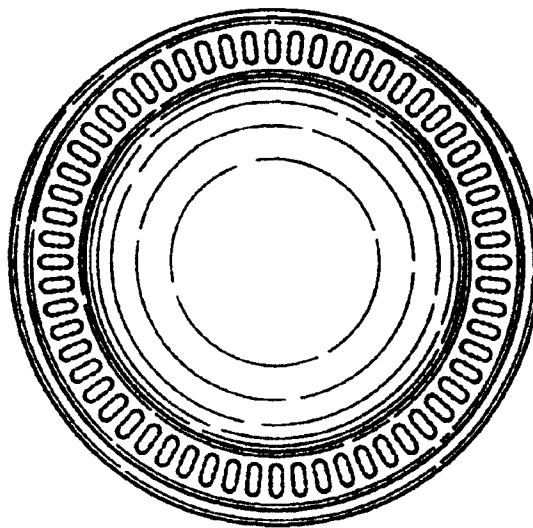
*Fig. 7*



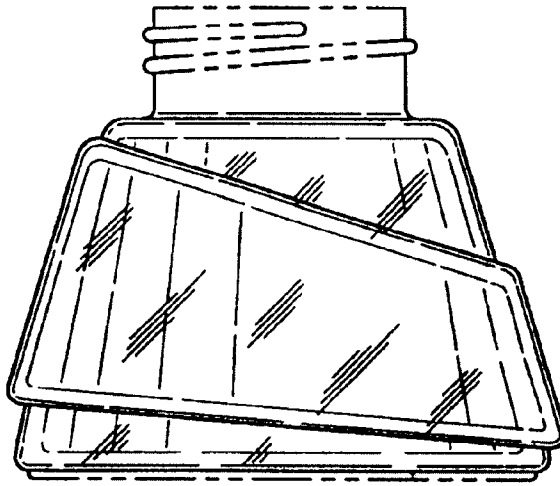
*Fig. 8*



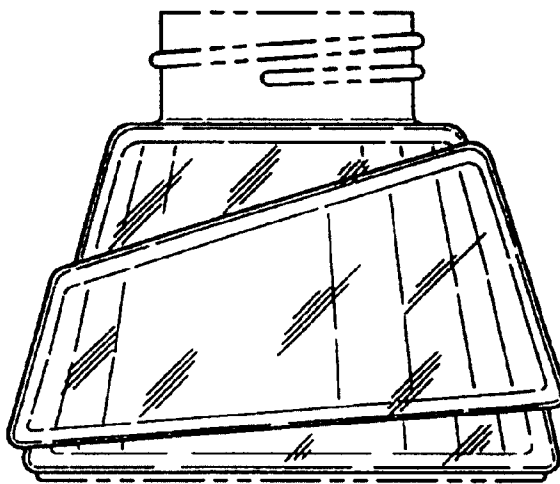
*Fig. 9*



*Fig. 10*

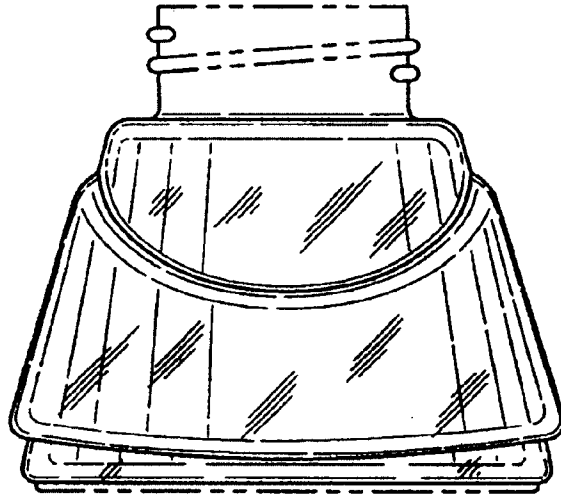


*Fig. 11*

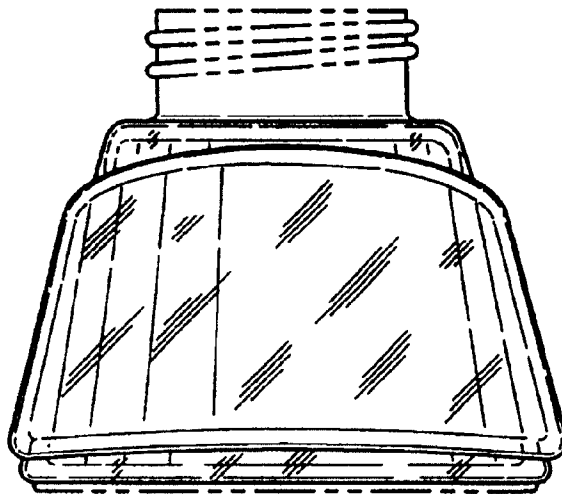


*Fig. 12*





*Fig. 13*



*Fig. 14*