



US00D735459S

(12) **United States Design Patent**  
**Choi**

(10) **Patent No.:** **US D735,459 S**

(45) **Date of Patent:** **\*\* Aug. 4, 2015**

(54) **FOOTWEAR**

(71) Applicant: **Sandra Choi**, London (GB)

(72) Inventor: **Sandra Choi**, London (GB)

(73) Assignee: **J. Choo Limited**, London (GB)

(\*\*) Term: **14 Years**

(21) Appl. No.: **29/459,464**

(22) Filed: **Jun. 28, 2013**

(30) **Foreign Application Priority Data**

Feb. 13, 2013 (EM) ..... 002183772-0041

(51) **LOC (10) Cl.** ..... **02-99**

(52) **U.S. Cl.** ..... **D2/971**  
USPC .....

(58) **Field of Classification Search**

USPC ..... D2/896, 925-942, 946, 969, 971; 36/1,  
36/83, 8.3, 45-58, 104, 108, 76 R

See application file for complete search history.

(56) **References Cited**

**U.S. PATENT DOCUMENTS**

D92,201 S 5/1934 Perugia  
D93,196 S \* 9/1934 Benjamin ..... D2/931  
D94,064 S \* 12/1934 Arkin ..... D2/939

D94,267 S \* 1/1935 Goldberg ..... D2/971  
D94,902 S \* 3/1935 Jackson ..... D2/971  
D632,470 S 2/2011 Guers-Neyraud

\* cited by examiner

*Primary Examiner* — Dominic Simone

(74) *Attorney, Agent, or Firm* — Fross Zelnick Lehman & Zissu, P.C.; Lawrence E. Apolzon, Esq.

(57) **CLAIM**

The ornamental design for footwear, as shown and described.

**DESCRIPTION**

FIG. 1 is a front perspective view of a footwear showing my design;

FIG. 2 is a right side view of the footwear shown in FIG. 1;

FIG. 3 is a left side view of the footwear shown in FIG. 1;

FIG. 4 is a front view of the footwear shown in FIG. 1;

FIG. 5 is a rear view of the footwear shown in FIG. 1;

FIG. 6 is a top view of the footwear shown in FIG. 1.

FIG. 7 is a front perspective view of a second embodiment of the footwear of FIG. 1;

FIG. 8 is a right side view of the footwear shown in FIG. 7;

FIG. 9 is a left side view of the footwear shown in FIG. 7;

FIG. 10 is a front view of the footwear shown in FIG. 7;

FIG. 11 is a rear view of the footwear shown in FIG. 7; and,

FIG. 12 is a top view of the footwear shown in FIG. 7.

The broken line showing of the heel, sole, zipper, laces, footbed and grommets are for illustrative purposes only and form no part of the claimed design.

**1 Claim, 12 Drawing Sheets**

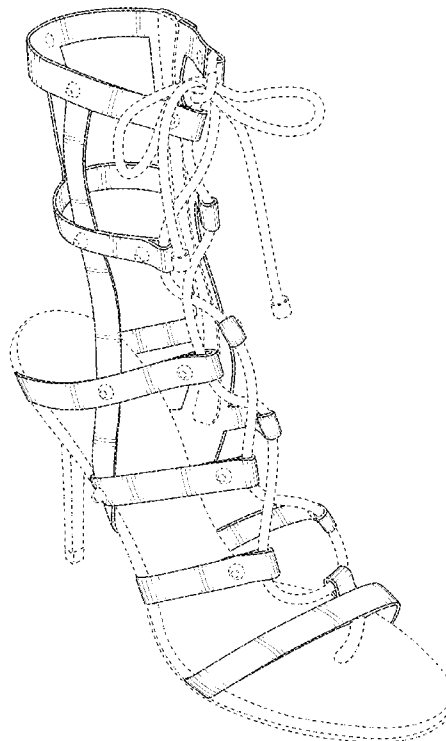
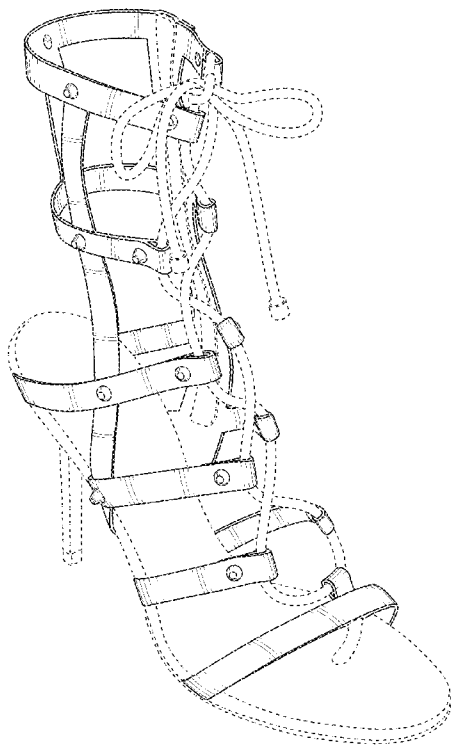

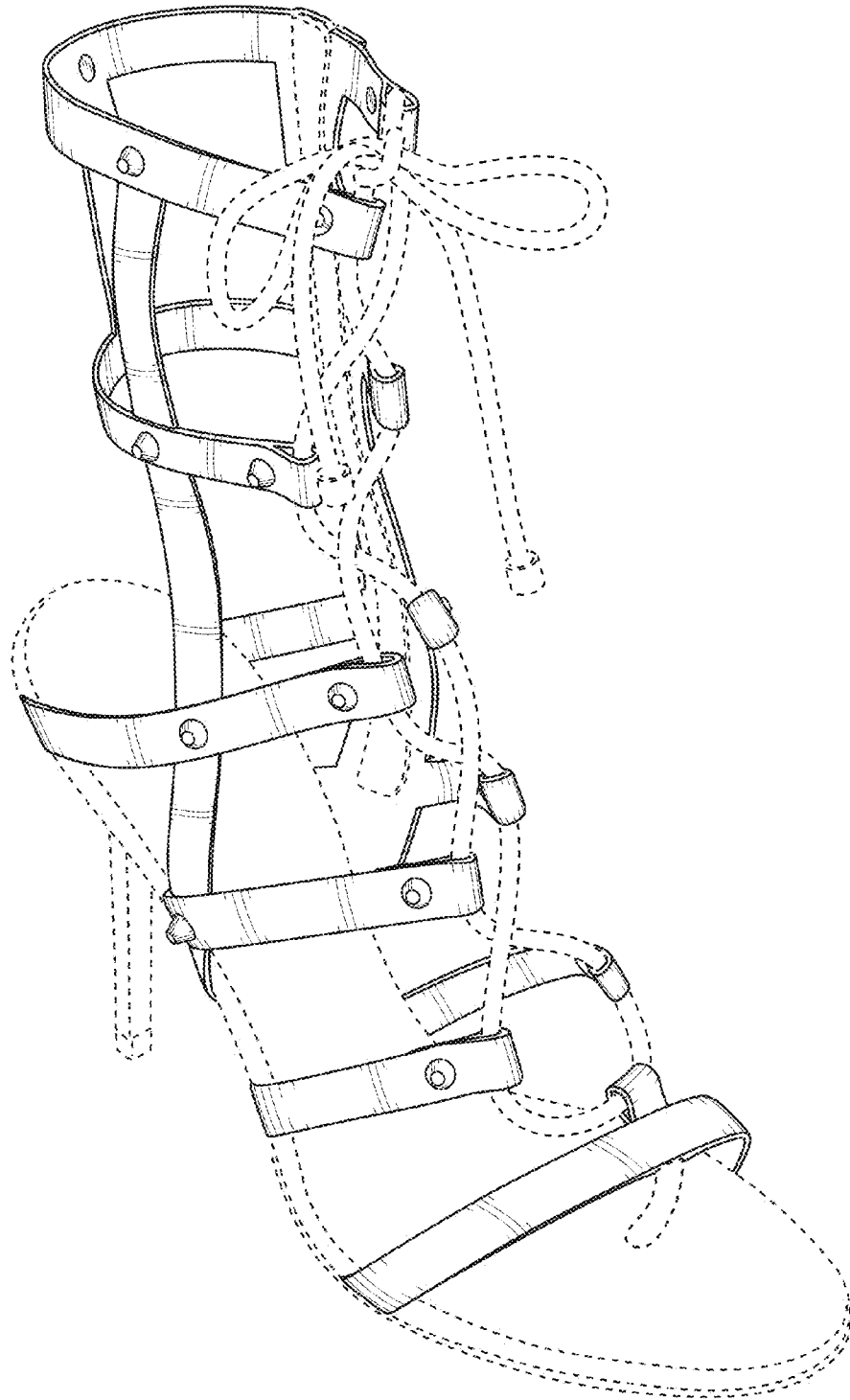

FIG. 1

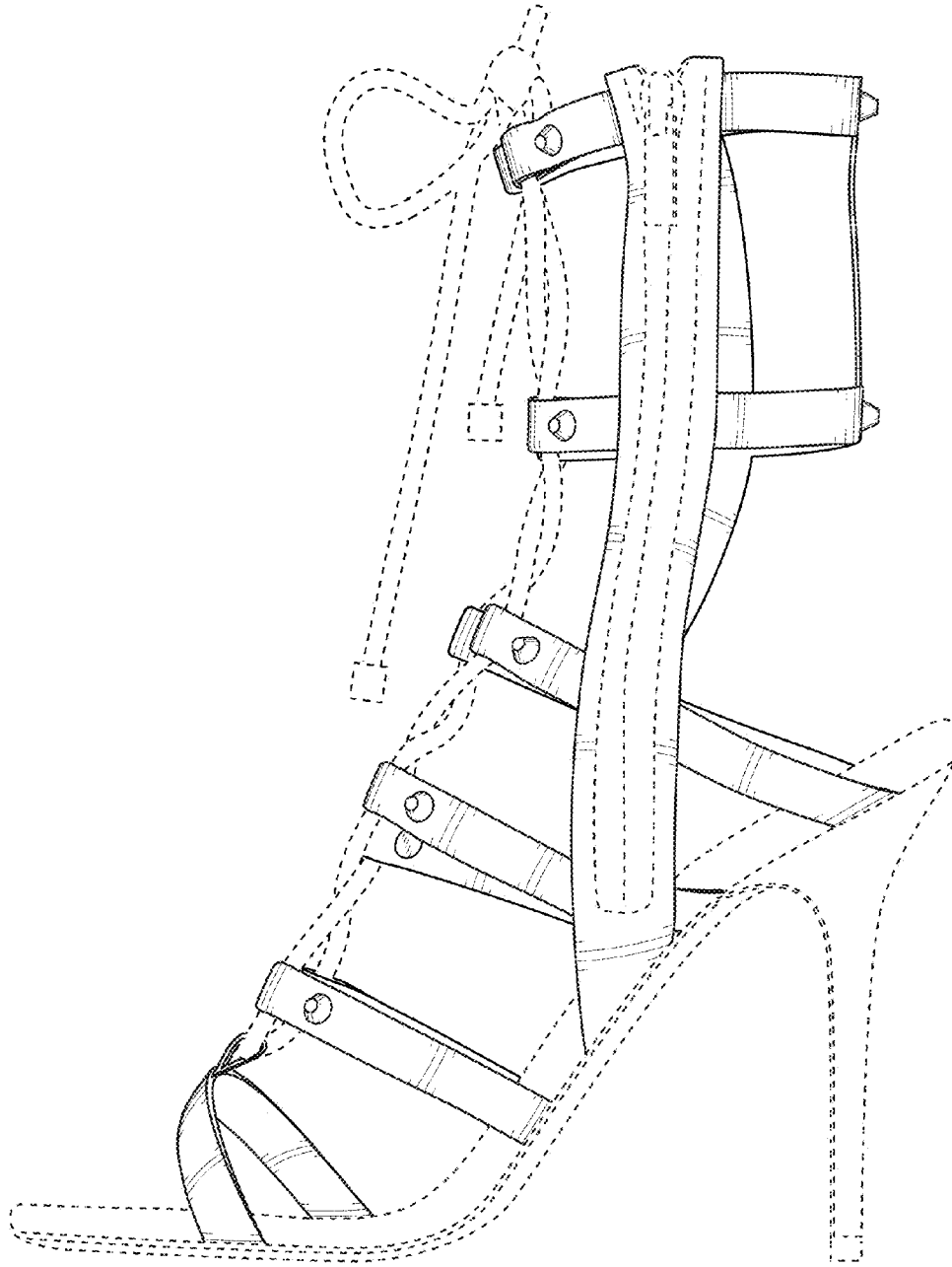

FIG. 2

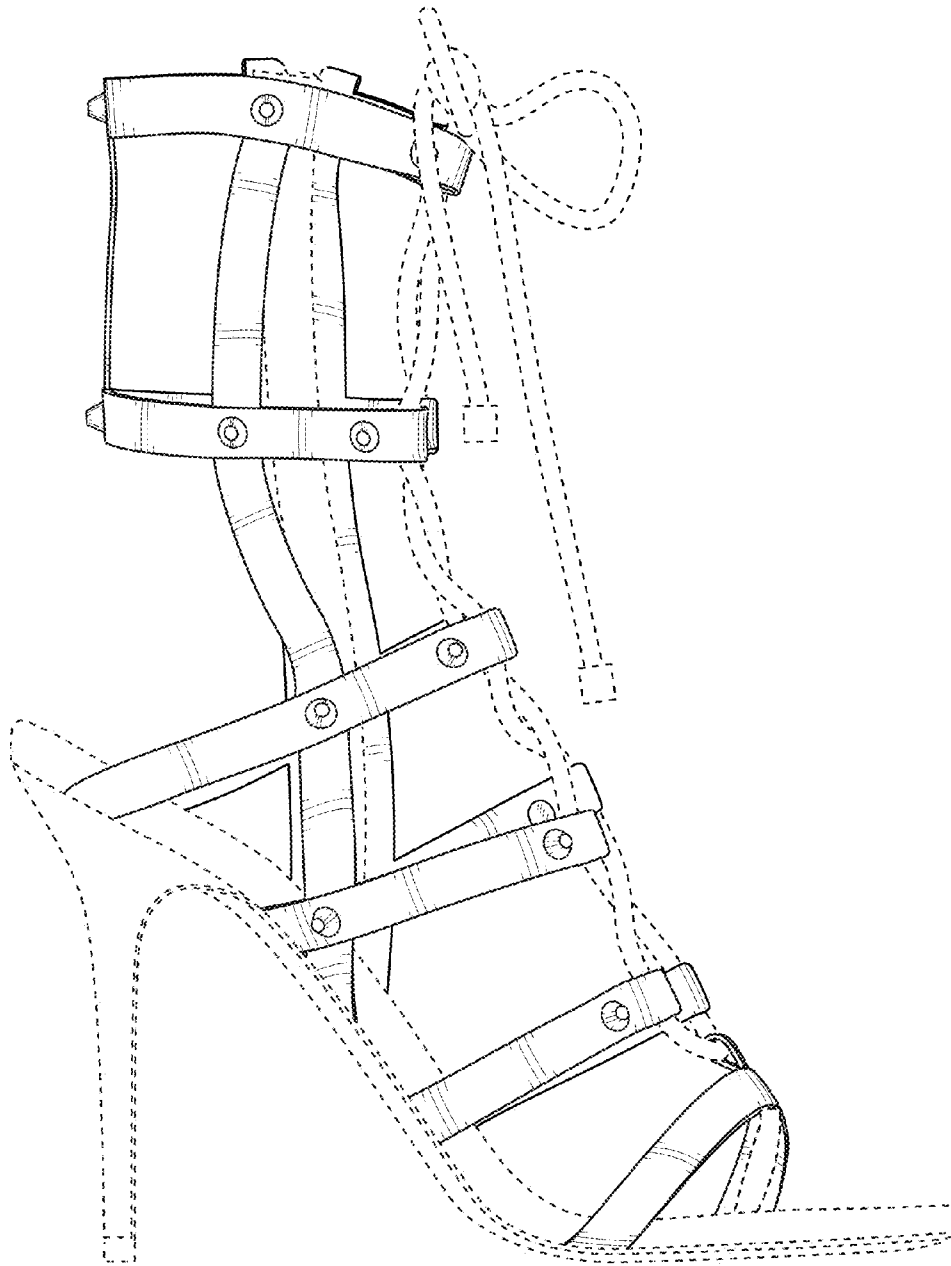

FIG. 3

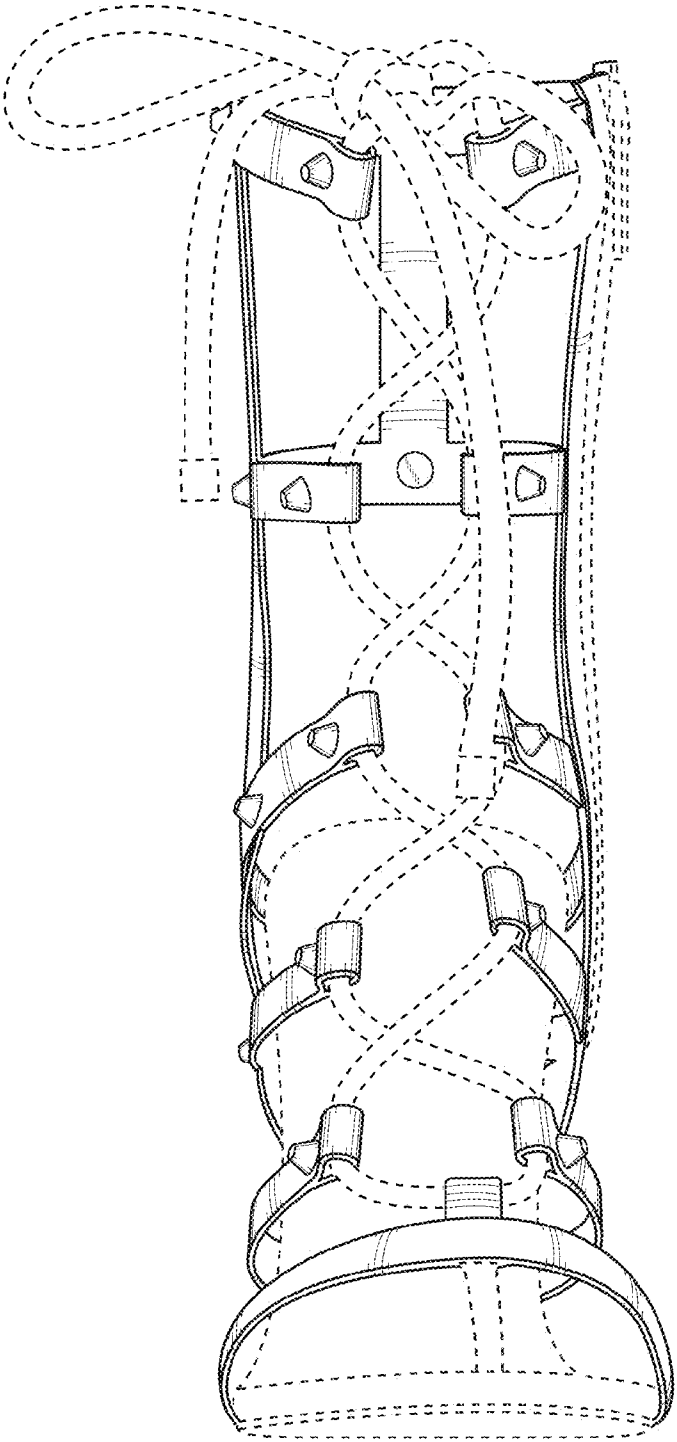

FIG. 4

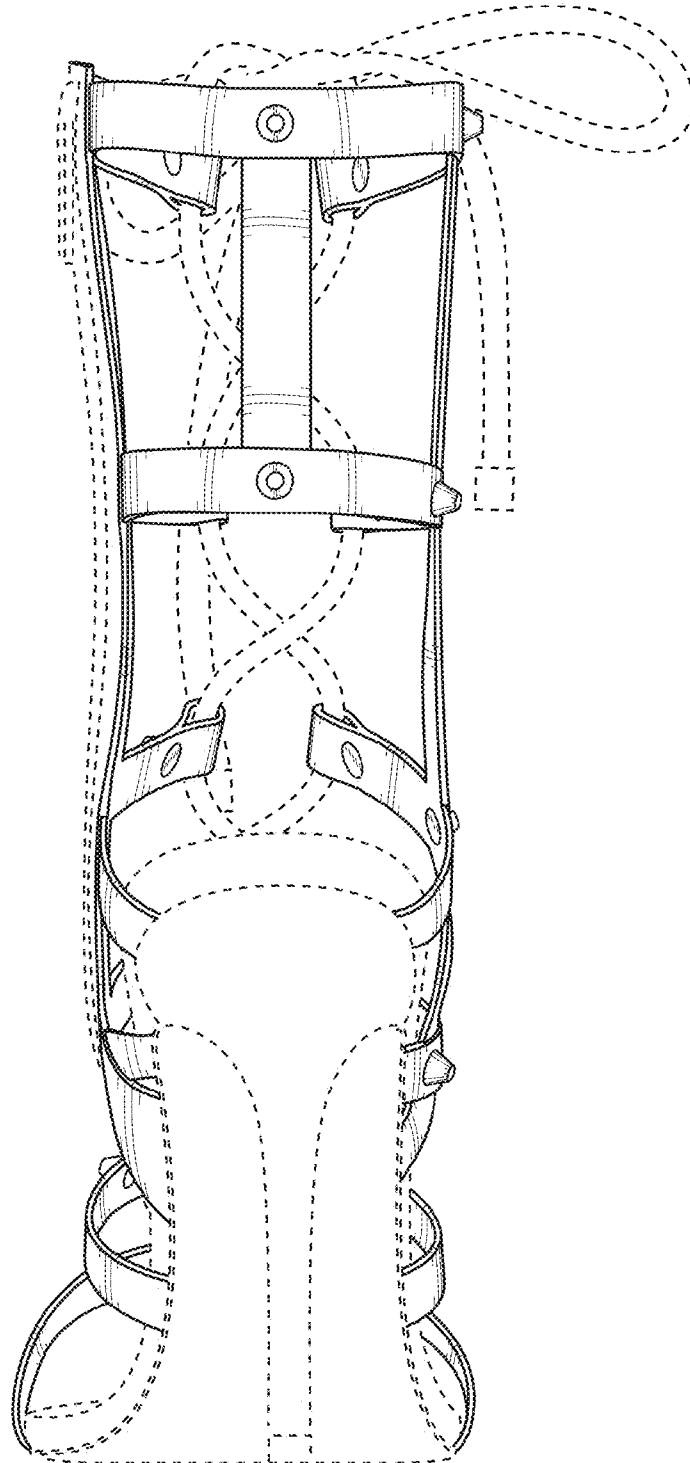

FIG. 5

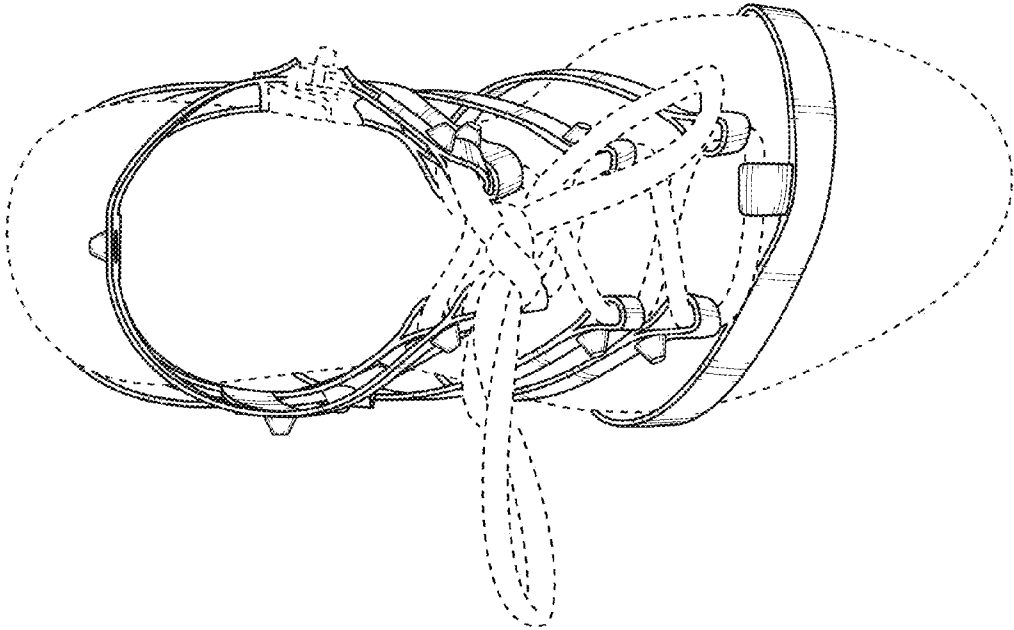

FIG. 6

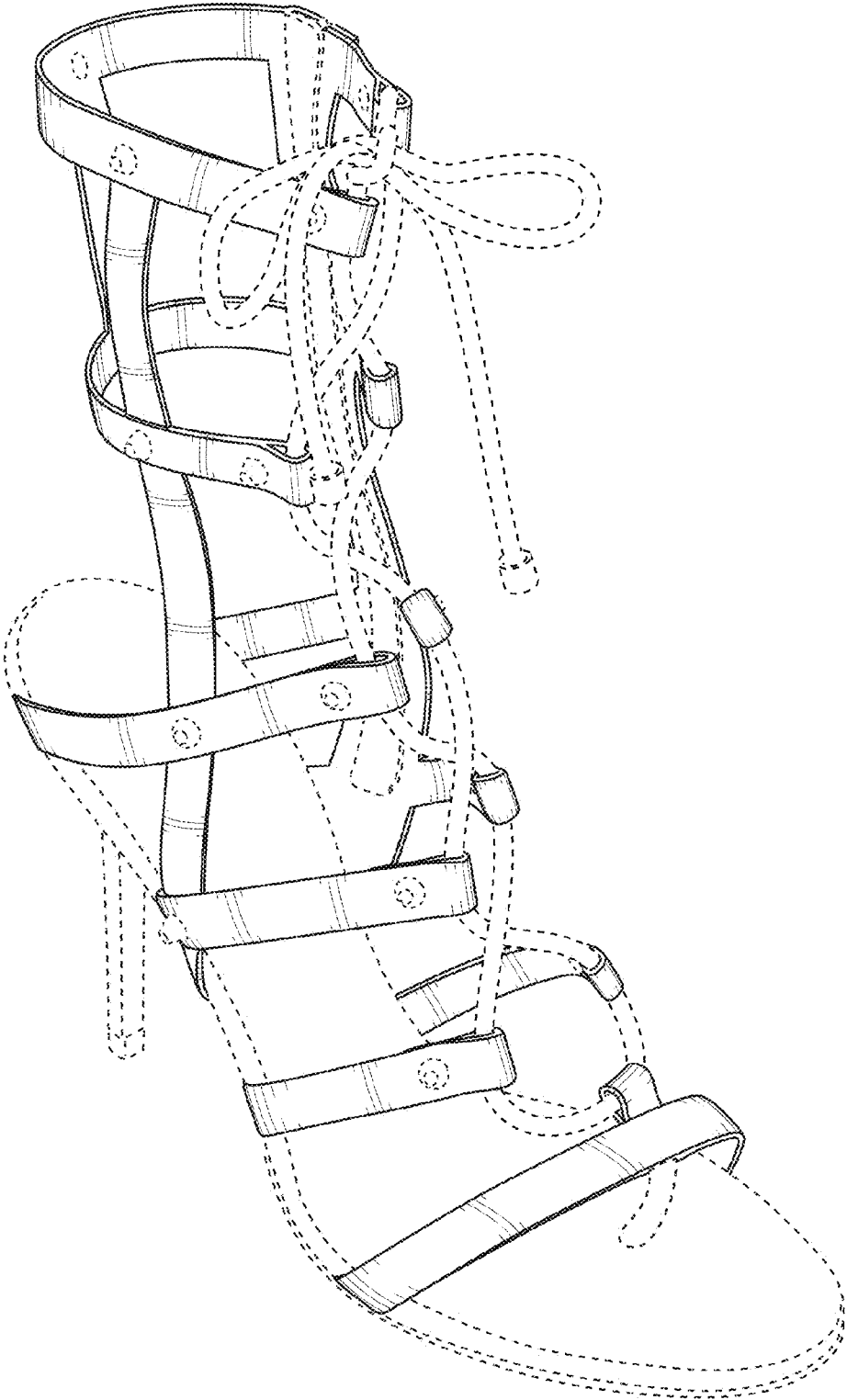

FIG. 7

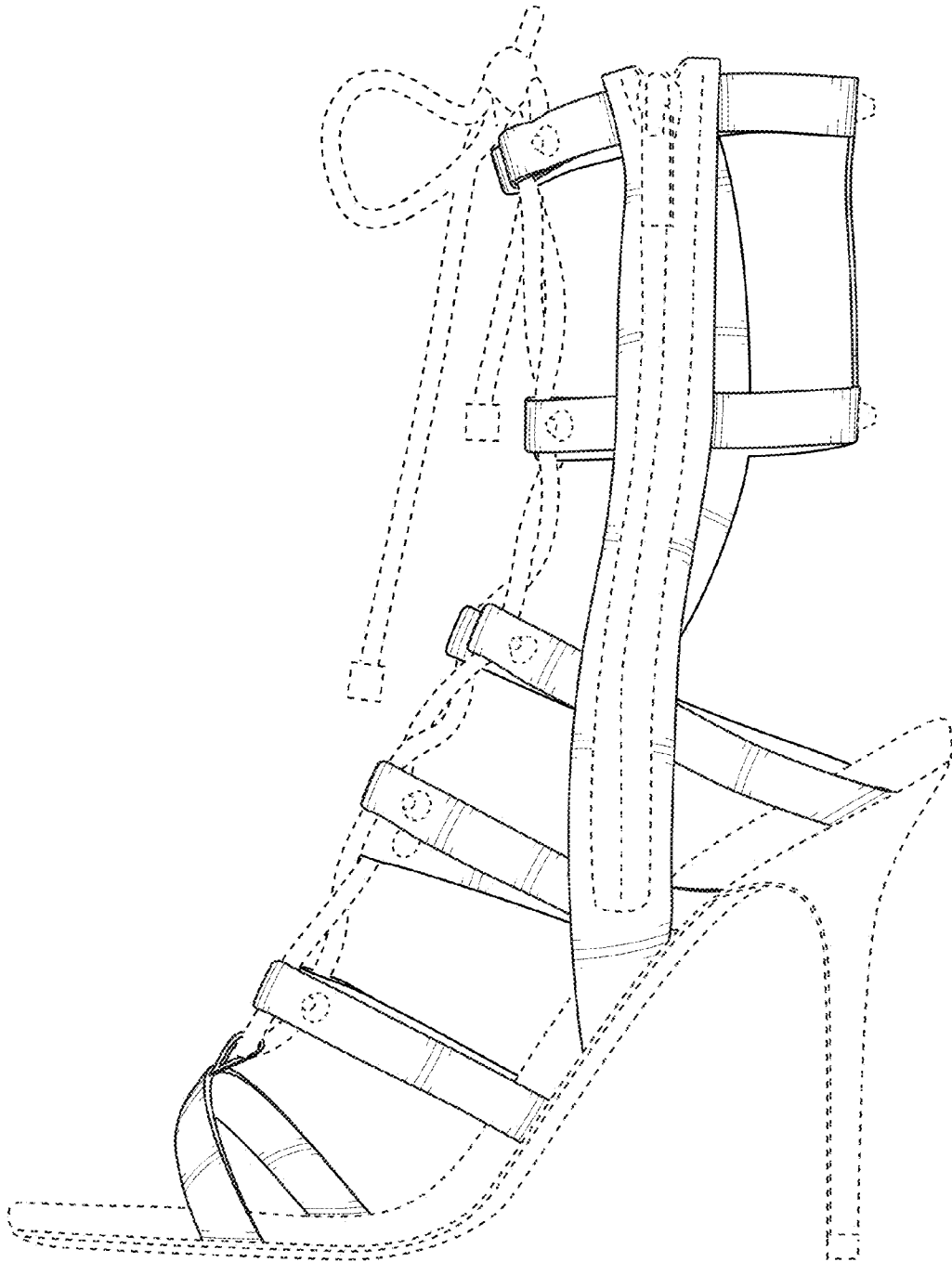

FIG. 8

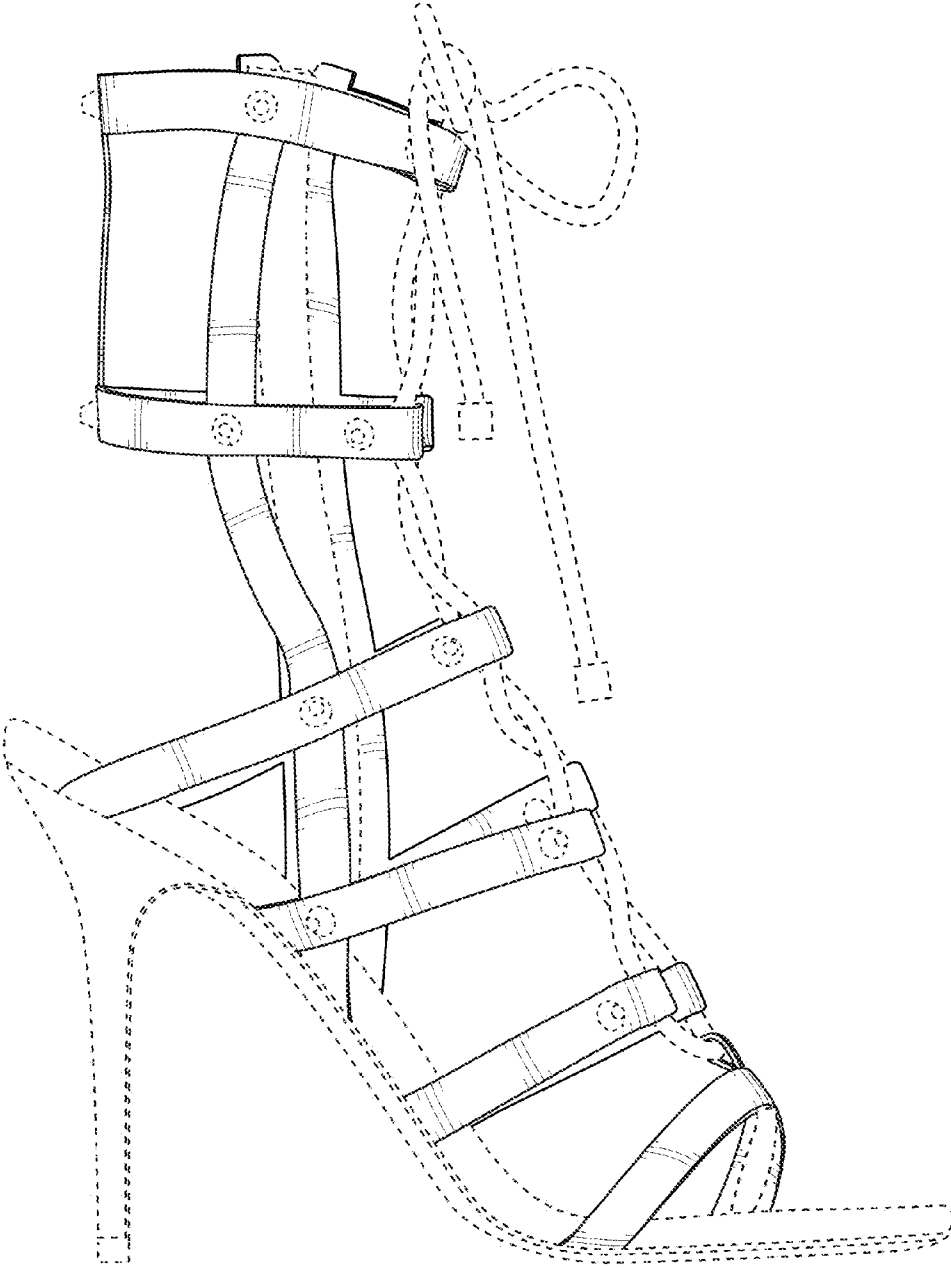

FIG. 9

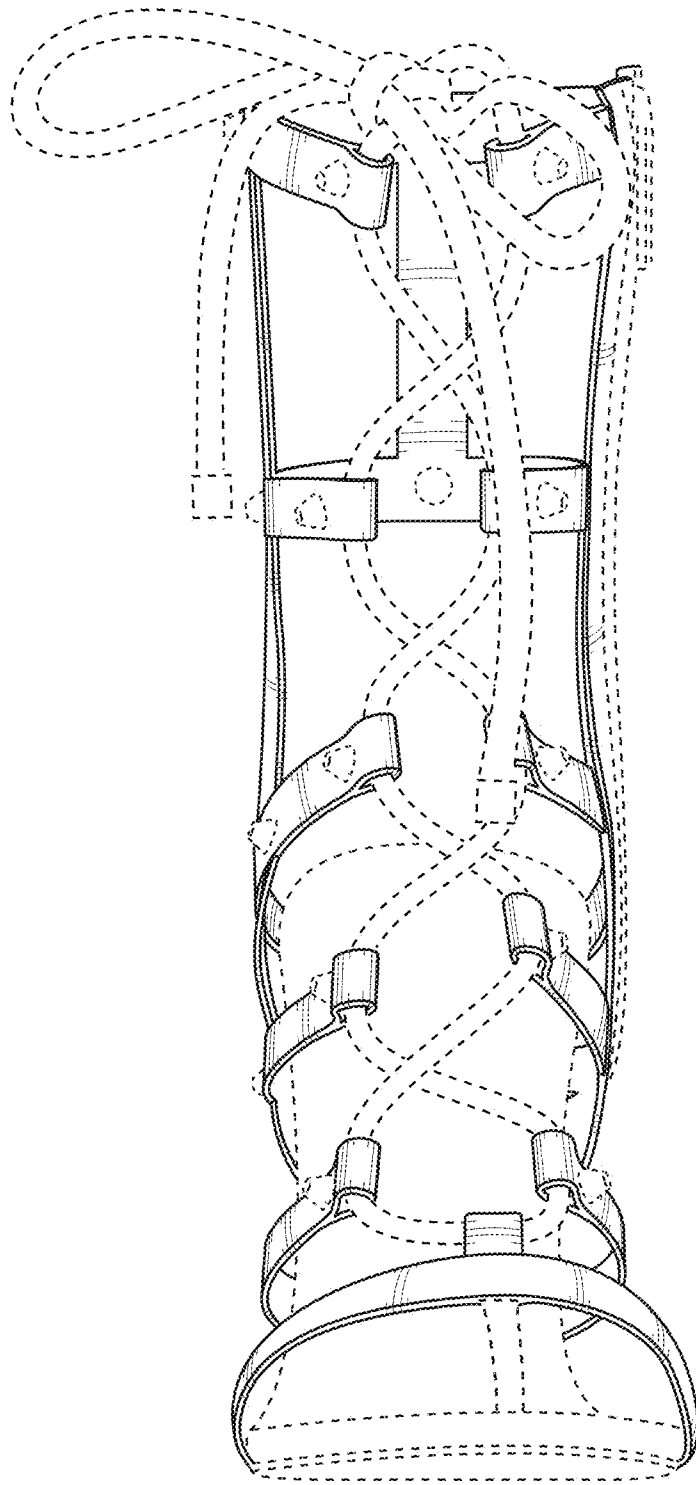

FIG. 10

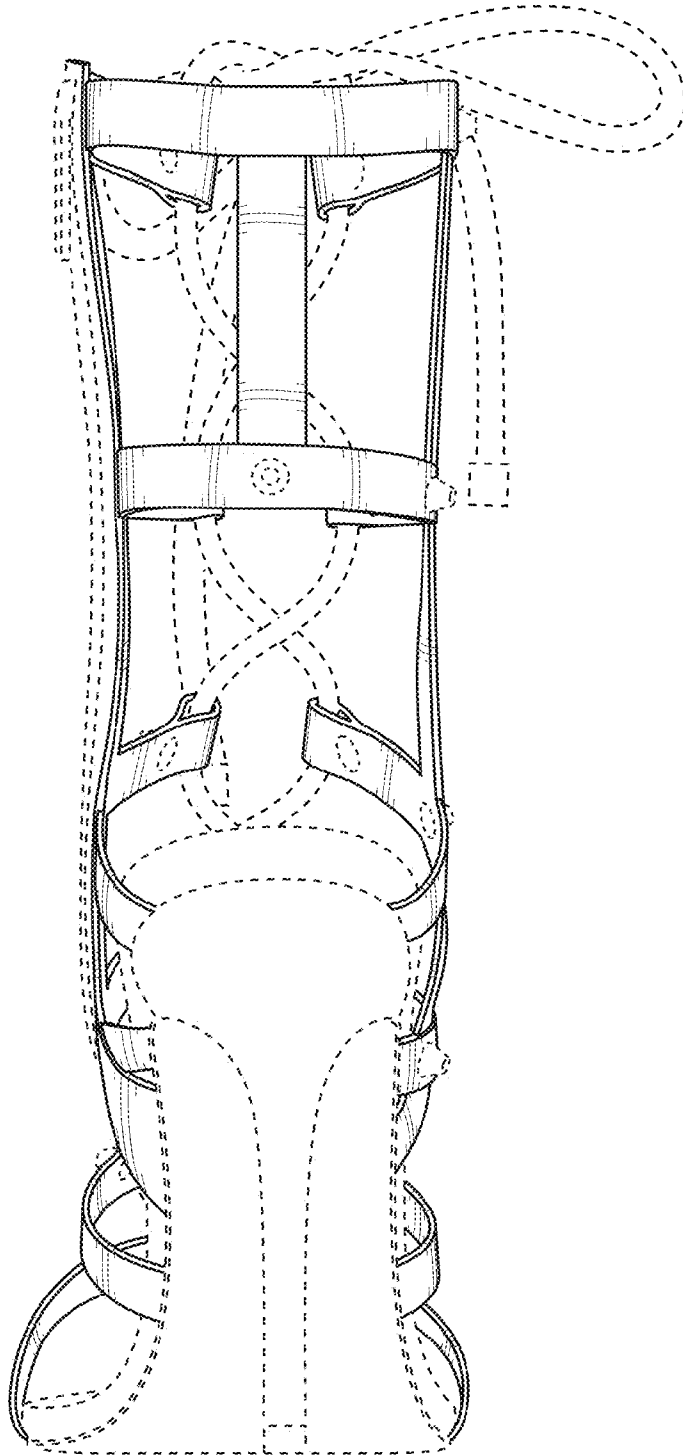

FIG. 11

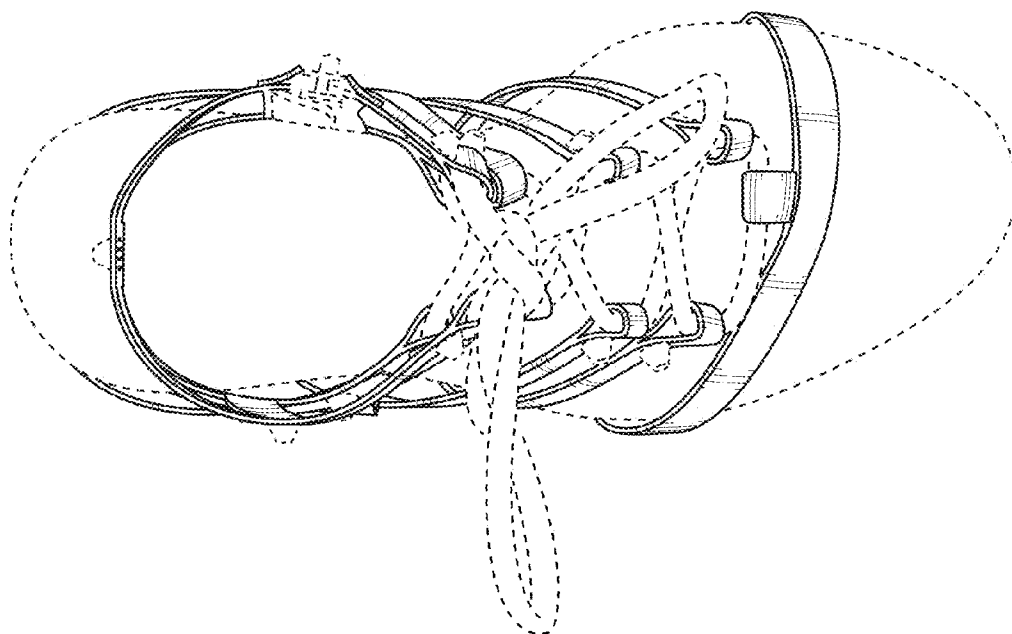

FIG. 12