



US00D512331S

(12) **United States Design Patent** (10) **Patent No.:** **US D512,331 S**
Mann (45) **Date of Patent:** **** Dec. 6, 2005**

(54) **CLOCK CASE**

(76) Inventor: **Robert W. Mann**, HCR-3, Box 953,
Tucson, AZ (US) 85739

(**) Term: **14 Years**

(21) Appl. No.: **29/210,102**

(22) Filed: **Jul. 23, 2004**

(51) **LOC (8) Cl.** **10-01**

(52) **U.S. Cl.** **D10/16; D10/28**

(58) **Field of Search** D10/1-29, 128;
368/276-278, 285, 10, 316, 317, 280, 88,
28, 82, 83, 179-183; D6/470-472

(56) **References Cited**

U.S. PATENT DOCUMENTS

D47,187	S	*	4/1915	Herschede	D10/16
D48,689	S	*	3/1916	Jacques	D10/16
1,676,030	A	*	7/1928	Helin	368/228
D83,724	S	*	3/1931	Fortney	D10/2
D98,086	S	*	1/1936	Pollard	D6/471
D98,206	S	*	1/1936	Pollard	D6/471
D240,118	S	*	6/1976	Elsen	D10/16
D317,412	S	*	6/1991	LeVita	D10/28
D319,787	S	*	9/1991	LeVita	D10/1
D362,131	S	*	9/1995	Walters, III	D6/401
D400,109	S		10/1998	Mann	
D496,287	S	*	9/2004	Mann	D10/16

OTHER PUBLICATIONS

Swiss Watch & Jewelry Journal, Feb., 1982, p. 212, item #2,
clock.*

European Jewelry, Jul. 1987, p. 40, clock, upper right.*

* cited by examiner

Primary Examiner—Lucy Lieberman

(74) *Attorney, Agent, or Firm*—Gavin J. Milczarek-Desai;
Quarles & Brady Steich Lang LLP

(57) **CLAIM**

The ornamental design for a clock case, as shown and
described.

DESCRIPTION

FIG. 1 is a perspective view of a clock case showing my
design;

FIG. 2 is an elevational view of the front side thereof;

FIG. 3 is a side elevation taken from the right side of FIG.
2;

FIG. 4 is an elevational view of the back side thereof;

FIG. 5 is a side elevation taken from the left side of FIG. 2;

FIG. 6 is a top plan view thereof;

FIG. 7 is a cross-sectional view taken from line 7 in FIG. 4;

FIG. 8 is a cross-sectional view taken from line 8 in FIG. 4;

FIG. 9 is a bottom plan view thereof;

FIG. 10 is a cross sectional view taken from line 10 in FIG
4; and,

FIG. 11 is a cross-sectional view taken from line 11 in FIG.
4.

1 Claim, 3 Drawing Sheets

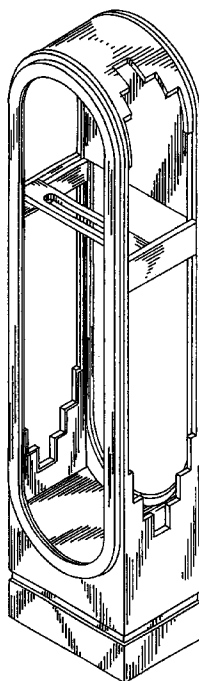

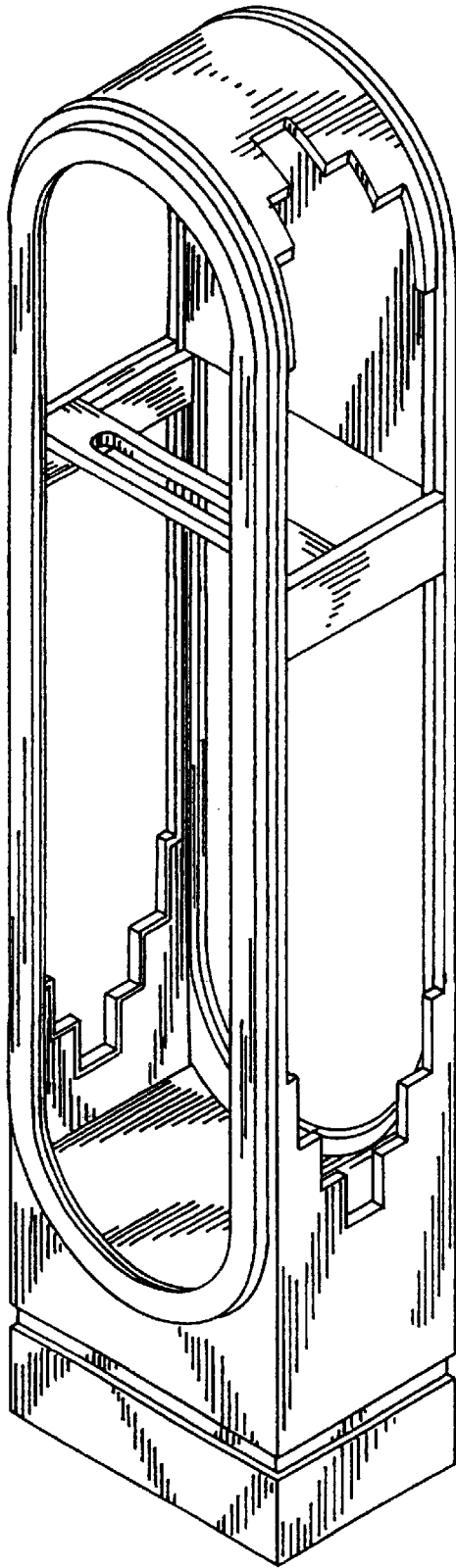

FIG. 1

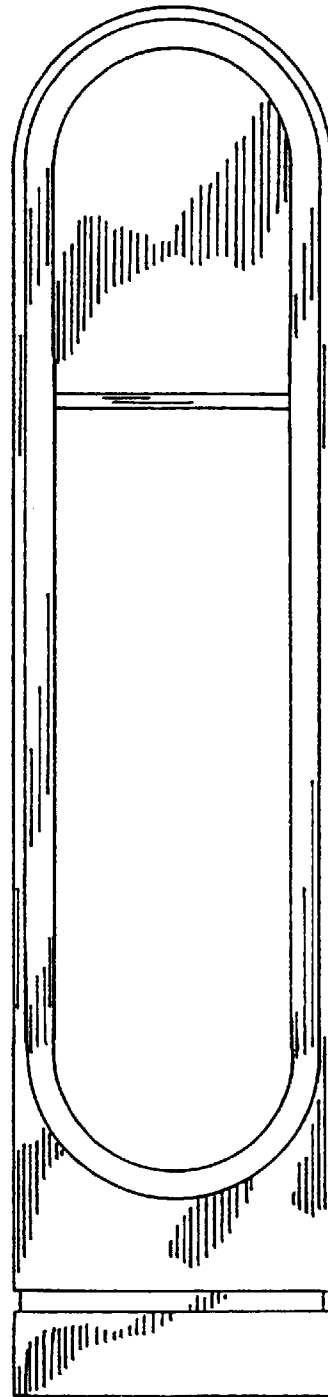

FIG. 2

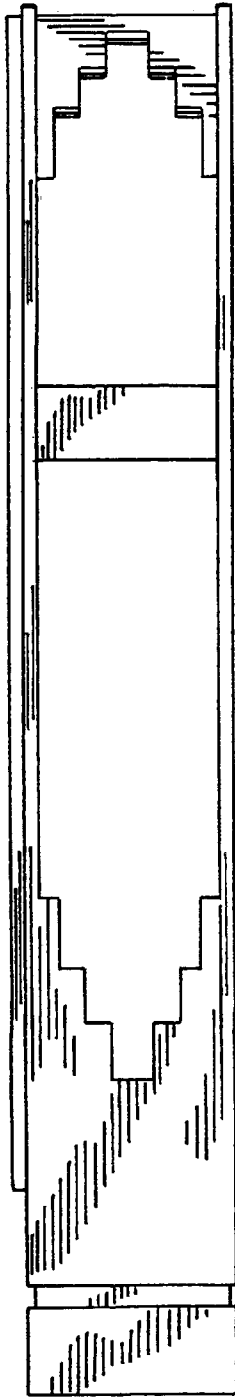

FIG. 3

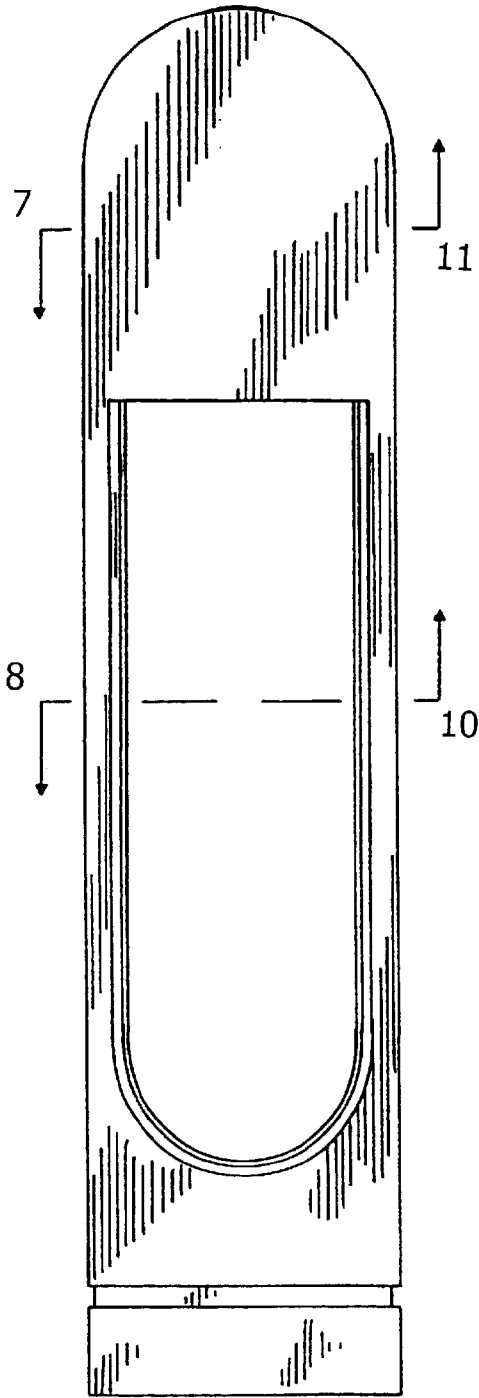

FIG. 4

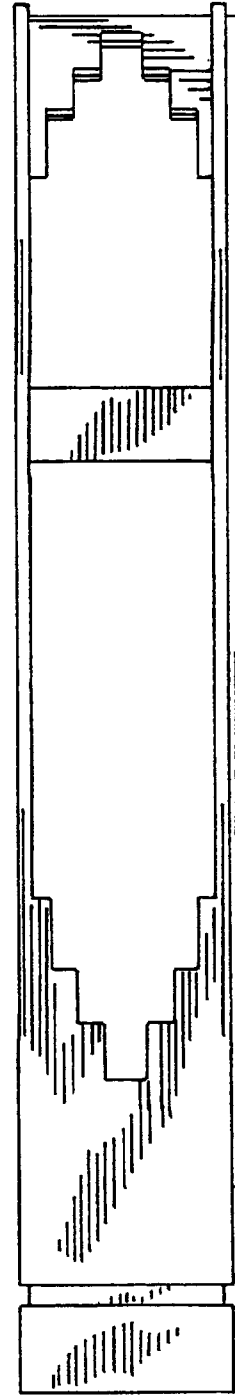

FIG. 5

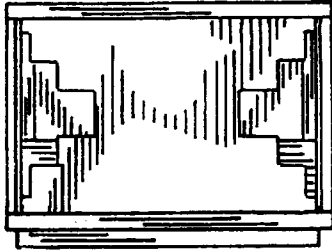

FIG. 6

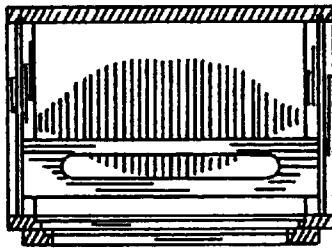

FIG. 7

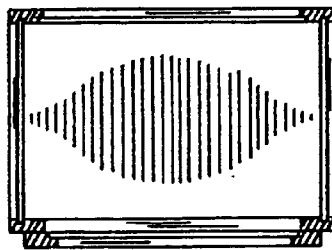

FIG. 8

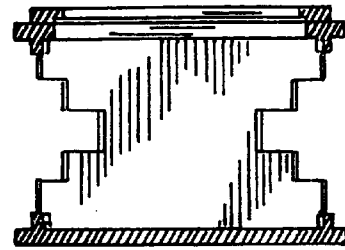

FIG. 11

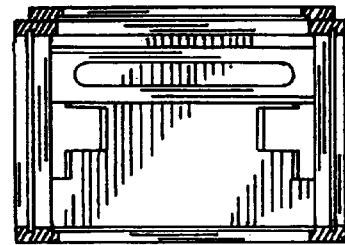

FIG. 10



FIG. 9