



US00D762329S

(12) **United States Design Patent**  
**Teller et al.**

(10) **Patent No.:** **US D762,329 S**

(45) **Date of Patent:** **\*\* \*Jul. 26, 2016**

(54) **COSMETIC PRODUCT CONTAINER**

(71) Applicant: **EOS PRODUCTS, LLC**, New York, NY (US)

(72) Inventors: **Jonathan Teller**, New York, NY (US);  
**Sanjiv Mehra**, New York, NY (US);  
**Peter Waxman**, New York, NY (US);  
**Jospeh Speter**, New York, NY (US);  
**Sherry Jhawar**, New York, NY (US);  
**Hamish Campbell**, New York, NY (US)

(73) Assignee: **EOS PRODUCTS, LLC**, New York, NY (US)

(\*) Notice: This patent is subject to a terminal disclaimer.

(\*\*) Term: **14 Years**

(21) Appl. No.: **29/479,116**

(22) Filed: **Jan. 13, 2014**

(51) **LOC (10) Cl.** ..... **28-03**

(52) **U.S. Cl.**  
USPC ..... **D28/82**; D28/88; D9/519; D9/552;  
D9/554

(58) **Field of Classification Search**

USPC ..... D28/85-91, 82, 76-79, 4-7, 8.1, 8.2, 9;  
D9/502, 570, 503, 504, 519, 552, 554,  
D9/557, 564, 566, 567, 600, 726, 601, 551,  
D9/521, 416, 529, 438, 435; D24/101,  
D24/102; D1/127, 130; D5/43, 44, 56, 59,  
D5/60, 62, 55; 132/316, 317, 318, 320;  
206/581, 823, 385; D3/265, 270,  
D3/271.1; 424/467; D14/489  
CPC ..... B65D 1/00; B65D 3/00; B65D 5/00;  
B65D 11/00; B65D 25/00; B65D 81/00  
See application file for complete search history.

(56) **References Cited**

U.S. PATENT DOCUMENTS

1,852,455 A 4/1932 Friedman  
3,167,079 A \* 1/1965 Weil ..... 134/137

3,292,840 A \* 12/1966 Schmidt ..... 220/4.25  
3,494,515 A \* 2/1970 Fattori ..... 222/548  
4,765,501 A \* 8/1988 Kao ..... 220/4.21  
5,044,496 A 9/1991 Tanaka  
D322,558 S \* 12/1991 Halm et al. .... D32/29.1  
D378,275 S \* 3/1997 Rusnock et al. .... D9/545

(Continued)

FOREIGN PATENT DOCUMENTS

JP 1136041 S 3/2002  
JP 2001321140 A 11/2004

OTHER PUBLICATIONS

SIPO Office Action issued Jul. 17, 2014 in connection with CN Appl. No. 201080063211.X citing JP 2004-321410A and JP 1136041S (listed separately).

*Primary Examiner* — Marianne Pandozzi

*Assistant Examiner* — Jae Liang

(74) *Attorney, Agent, or Firm* — Martin & Ferraro, LLP

(57) **CLAIM**

The ornamental design for a cosmetic product container, as shown and described.

**DESCRIPTION**

FIG. 1 is a front elevational view of a cosmetic product container showing my new design;  
FIG. 2 is a left side elevational view thereof;  
FIG. 3 is a right side elevational view thereof;  
FIG. 4 is a rear elevational view thereof;  
FIG. 5 is a top plan view thereof; and,  
FIG. 6 is a bottom plan view thereof.

The broken lines in the drawing depict portions of the cosmetic product container that form no part of the claimed design.

The stippling in FIGS. 1-6 shows contrast in appearance.

**1 Claim, 3 Drawing Sheets**

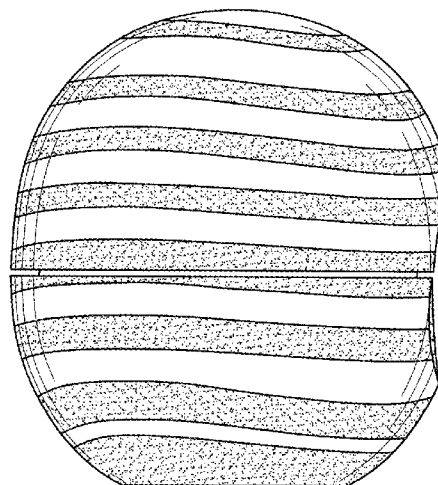
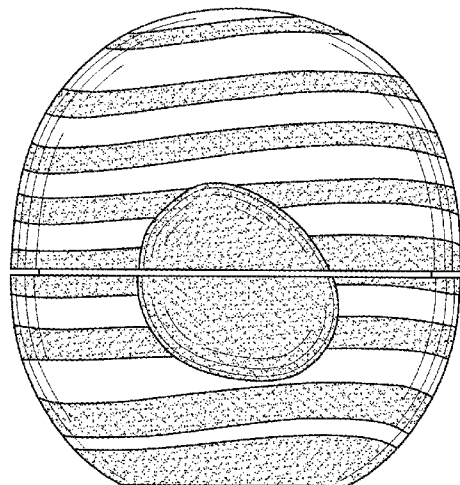

(56)

References Cited

U.S. PATENT DOCUMENTS

D396,382 S \* 7/1998 Hsu ..... D7/599  
 D403,123 S \* 12/1998 Sgariboldi ..... D28/76  
 6,193,427 B1 2/2001 Benguigui  
 D443,826 S \* 6/2001 Gnann et al. .... D9/537  
 D450,882 S \* 11/2001 Colwell et al. .... D28/4  
 D452,586 S \* 12/2001 Look ..... D28/4  
 D452,588 S \* 12/2001 Look ..... D28/4  
 6,391,972 B1 5/2002 Hatakeyama  
 D465,609 S \* 11/2002 Jackel-Marken ..... D28/4  
 D465,733 S \* 11/2002 Hill ..... D9/519  
 D472,014 S \* 3/2003 Jackel-Marken ..... D28/4  
 D512,199 S \* 12/2005 Ibanez ..... D1/129  
 D516,431 S \* 3/2006 Vintro ..... D9/521  
 D525,437 S \* 7/2006 Leisch et al. .... D5/53  
 D537,563 S \* 2/2007 Taniguchi et al. .... D28/4  
 D541,052 S \* 4/2007 Miller et al. .... D5/53

D552,997 S \* 10/2007 Blasko ..... D9/521  
 D554,529 S \* 11/2007 Green et al. .... D9/726  
 D564,900 S \* 3/2008 Green et al. .... D9/715  
 D570,219 S \* 6/2008 Blasko ..... D9/516  
 D579,213 S \* 10/2008 Aipa ..... D5/53  
 D592,064 S \* 5/2009 Kilany ..... D9/519  
 D592,512 S \* 5/2009 Dubitsky et al. .... D9/516  
 D599,560 S \* 9/2009 Sharma ..... D5/59  
 D609,107 S \* 2/2010 Dubitsky et al. .... D9/551  
 D612,245 S \* 3/2010 Canamasas Puigbo ..... D9/519  
 D631,204 S \* 1/2011 Dubitsky et al. .... D28/82  
 D688,000 S \* 8/2013 Johnson et al. .... D28/4  
 D689,366 S \* 9/2013 Kohne et al. .... D9/504  
 D695,552 S \* 12/2013 Gatto ..... D6/606  
 D705,988 S \* 5/2014 Scott et al. .... D28/7  
 D708,726 S \* 7/2014 Gordon et al. .... D23/356  
 D710,544 S \* 8/2014 Shen ..... D28/77  
 D715,142 S \* 10/2014 Allen et al. .... D9/434  
 D726,028 S \* 4/2015 Thompson ..... D9/726

\* cited by examiner

FIG. 1

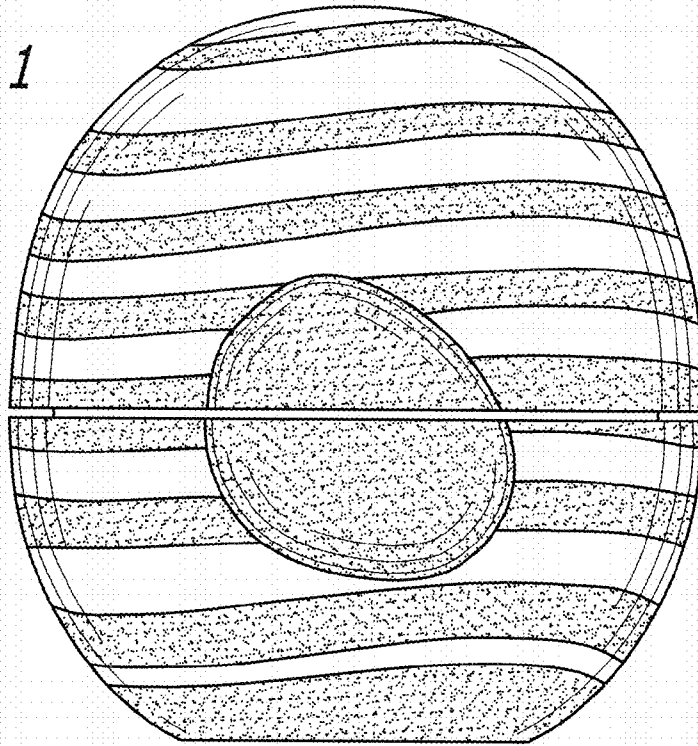

FIG. 2

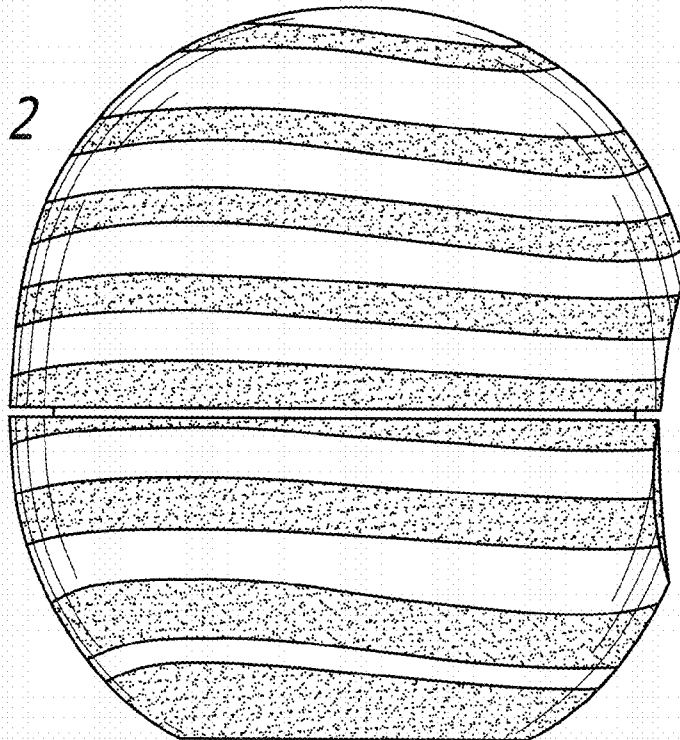

FIG. 3

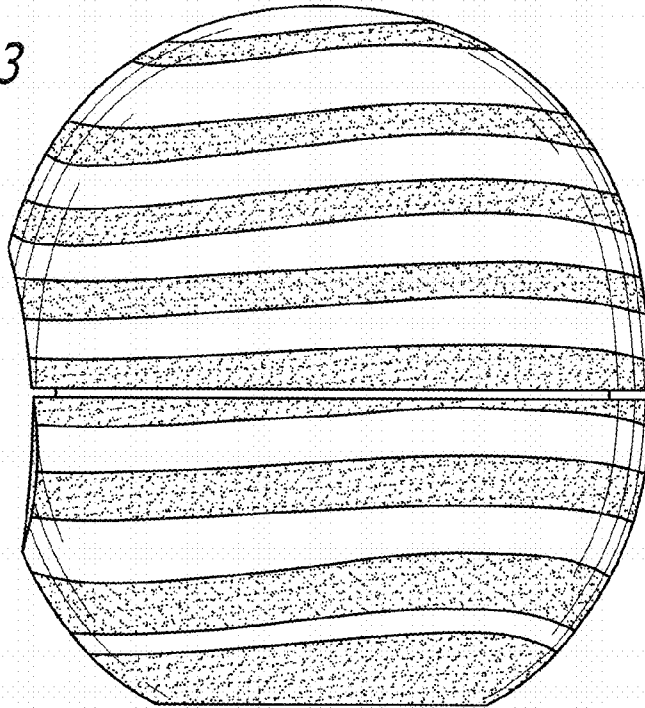

FIG. 4

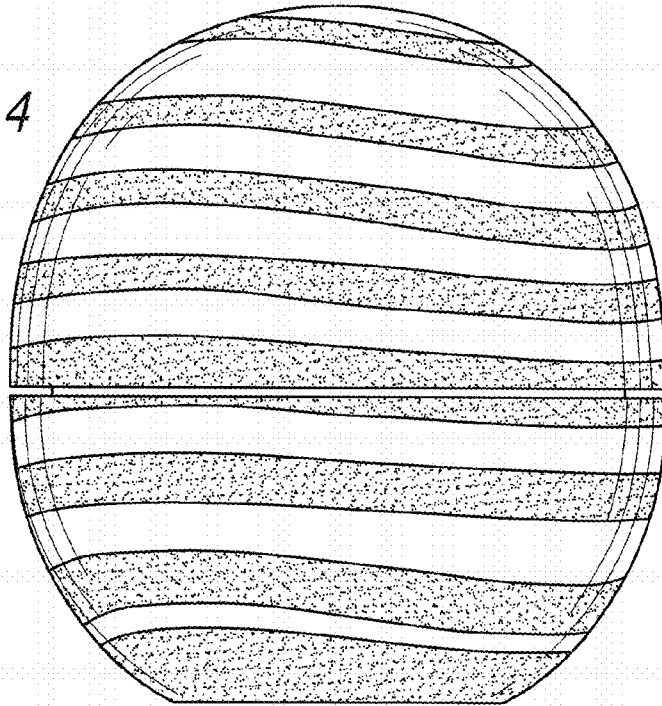

FIG. 5

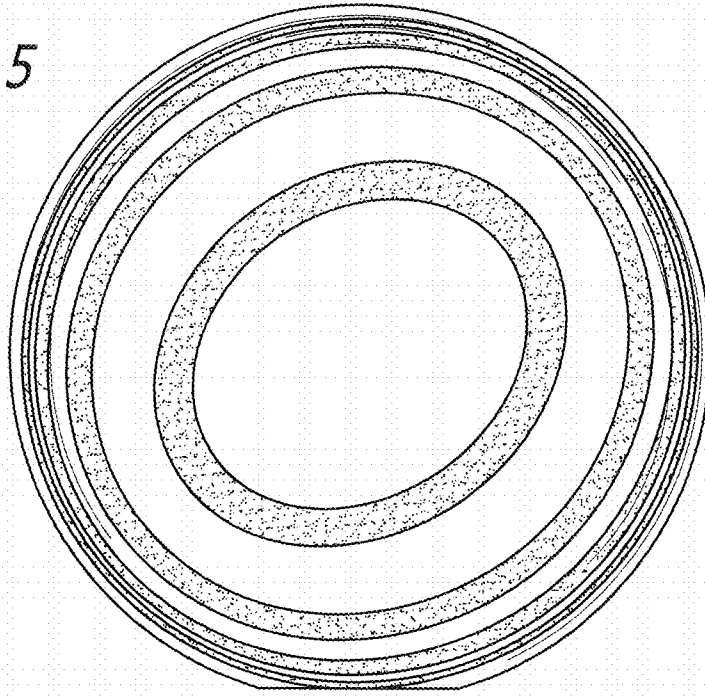

FIG. 6

