



US0D1052272S

(12) **United States Design Patent**
Kimel

(10) **Patent No.:** **US D1,052,272 S**

(45) **Date of Patent:** **** Nov. 26, 2024**

(54) **STORAGE BOX**

(71) Applicant: **Joel Kimel**, Potomac, MD (US)

(72) Inventor: **Joel Kimel**, Potomac, MD (US)

(**) Term: **15 Years**

(21) Appl. No.: **29/872,647**

(22) Filed: **Mar. 16, 2023**

(51) **LOC (14) Cl.** **03-01**

(52) **U.S. Cl.**

USPC **D3/294**; D27/189

(58) **Field of Classification Search**

USPC D3/201, 205, 260, 273, 282, 284, 294,
D3/295, 302, 905, 901, 313, 289;
D9/770, 782, 738, 739, 517, 715, 456;
D6/536, 516, 512, 673, 522, 671.1, 526,
D6/519; D28/83, 73, 76, 77; D27/183,
D27/186, 189

CPC .. F21V 35/00; A47K 5/03; B25H 3/06; B25H
3/021; A01K 97/06

See application file for complete search history.

(56) **References Cited**

U.S. PATENT DOCUMENTS

D354,622 S	1/1995	Lovell	
D371,056 S *	6/1996	Sullivan	D7/709
D376,314 S	12/1996	Krupa	
D386,904 S	12/1997	Bradshaw, Jr.	
D392,881 S	3/1998	Bulcher et al.	
D396,732 S *	8/1998	Bucher	D27/189
D434,229 S	11/2000	Van den Branden et al.	
D437,685 S	2/2001	Liu	
D480,181 S	9/2003	Sheng	

D491,358 S *	6/2004	Hofman	D3/273
D553,296 S	10/2007	Kuethe et al.	
D626,688 S *	11/2010	Gibson	D27/189
D880,860 S	4/2020	Liu	
D891,719 S	7/2020	Sponder et al.	
D1,004,278 S *	11/2023	Chen	D24/229
D1,009,357 S *	12/2023	Yang	D27/189

OTHER PUBLICATIONS

Instagram, “@picktulip posts”, Of note dated Jun. 5, 12, 18, 2022. (<https://www.instagram.com/picktulip/>) (Year: 2022).*

* cited by examiner

Primary Examiner — April Rivas

(57) **CLAIM**

The ornamental design for a storage box, as shown and described.

DESCRIPTION

FIG. 1 is a top left front perspective view of a storage box, showing my new design;
FIG. 2 is a front elevation view thereof;
FIG. 3 is rear elevation view thereof;
FIG. 4 is a left-side elevation view thereof, the right-side elevation view being a mirror image thereof;
FIG. 5 is a top plan view thereof; and,
FIG. 6 is a top left front perspective view of the storage box shown in an open condition.

The broken lines showing the contents of the storage box in FIG. 6 depicts environmental subject matter that forms no part of the claimed design, while the remaining broken lines shown in the drawings depict portions of the storage box that form no part of the claimed design.

1 Claim, 4 Drawing Sheets

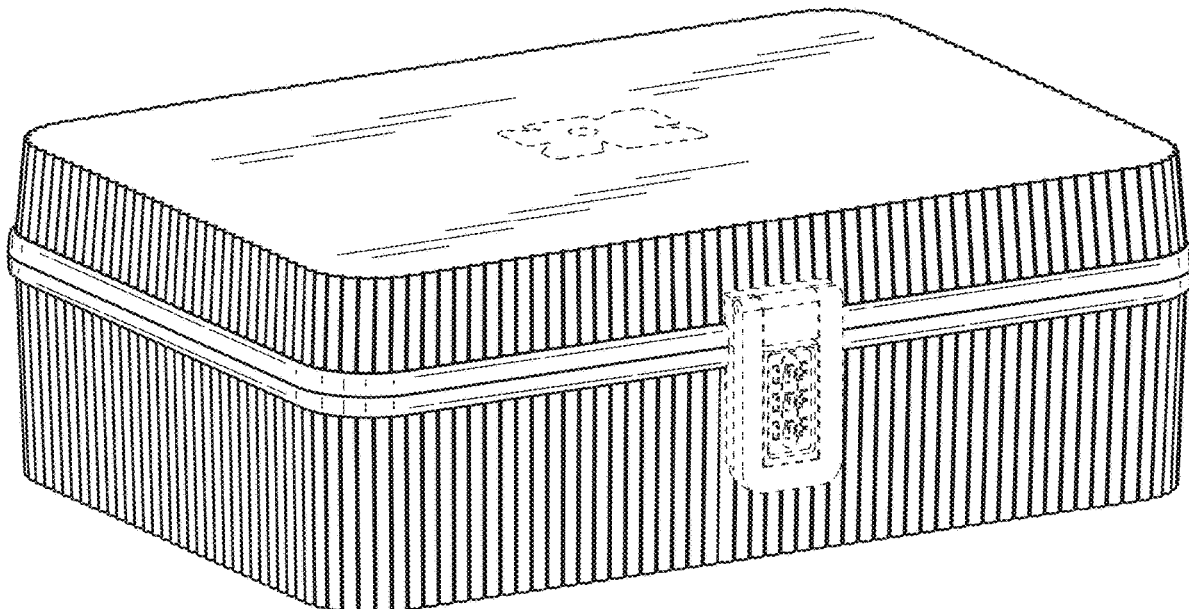

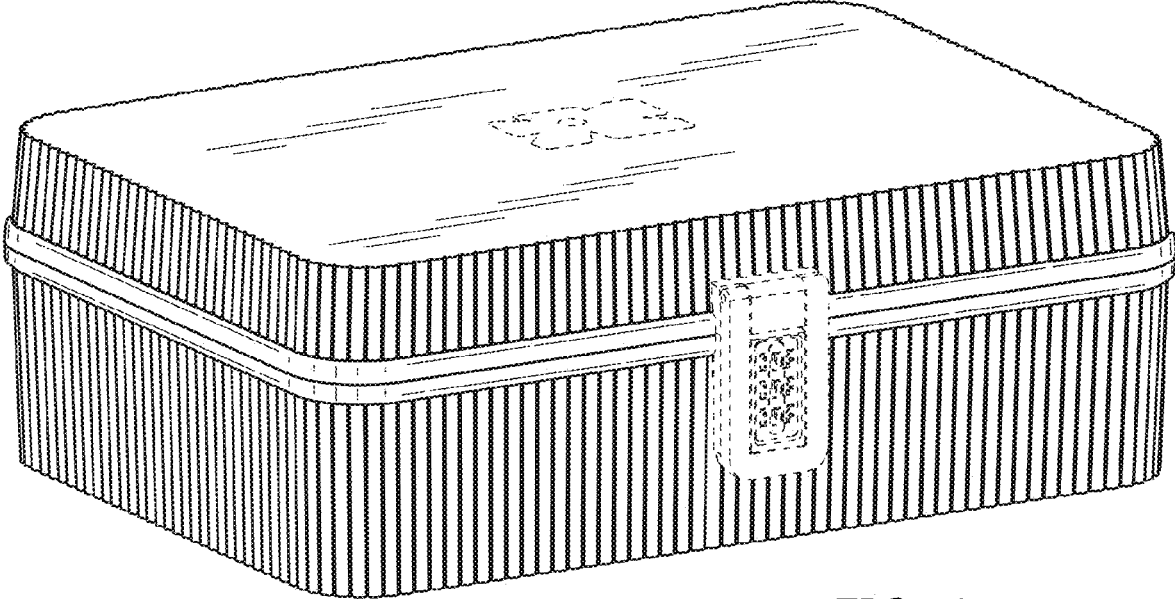

FIG. 1

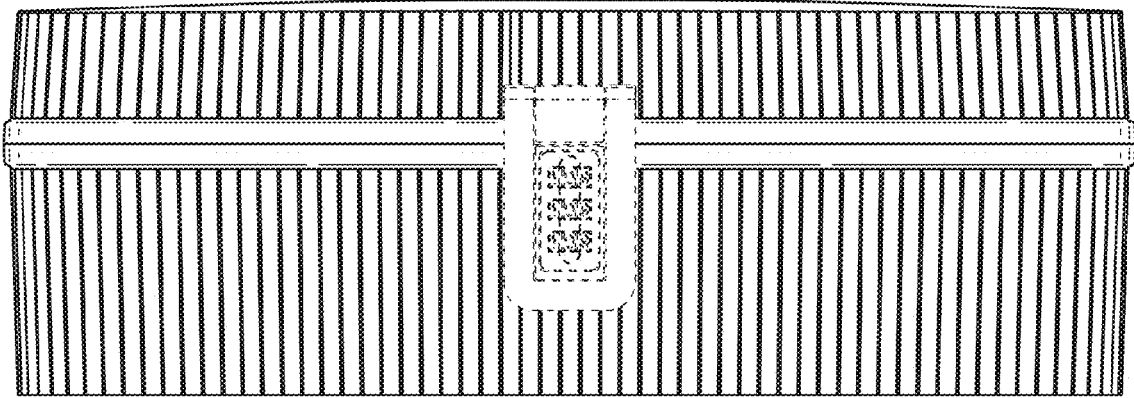

FIG. 2

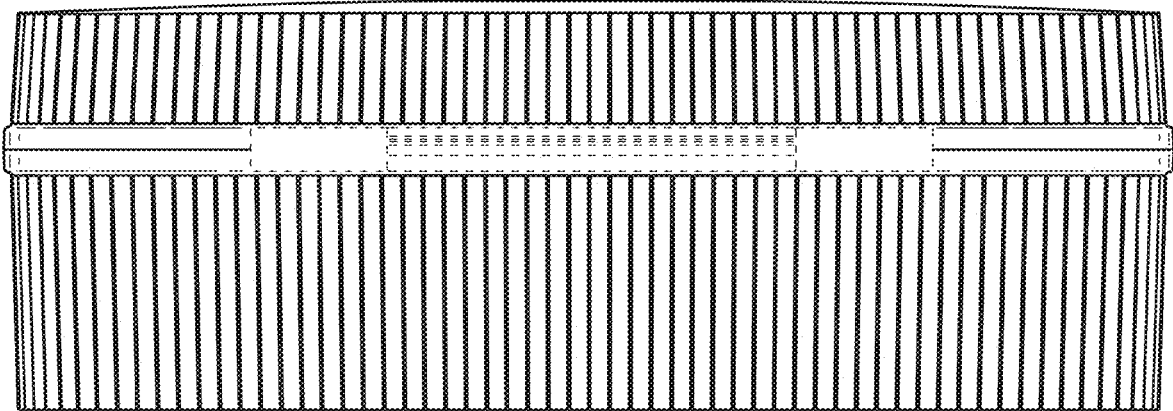

FIG. 3

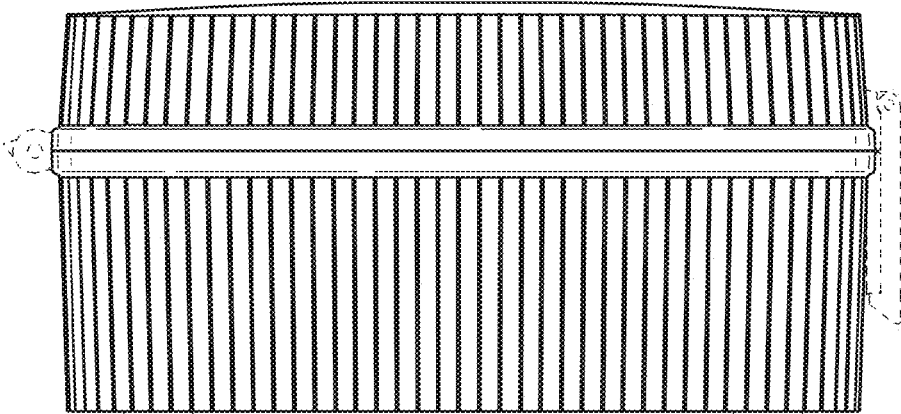

FIG. 4

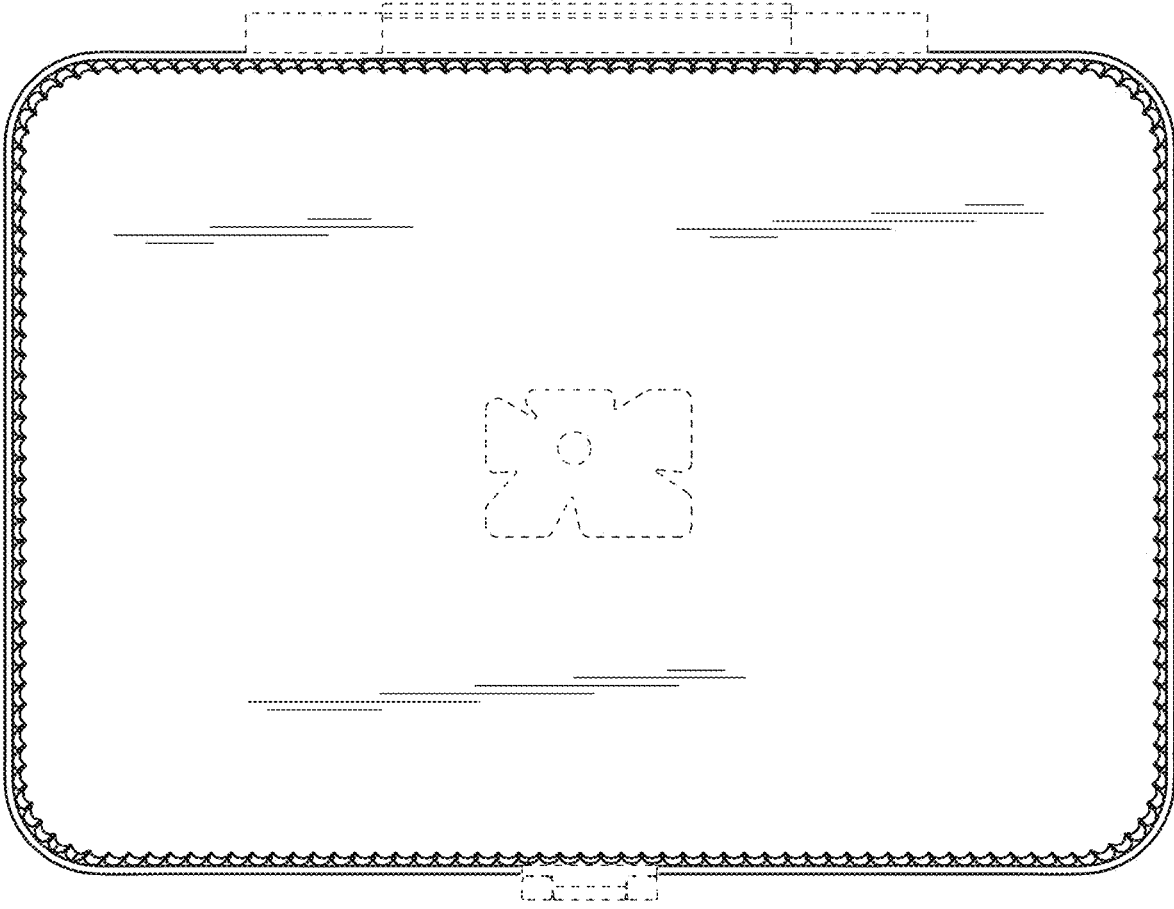

FIG. 5

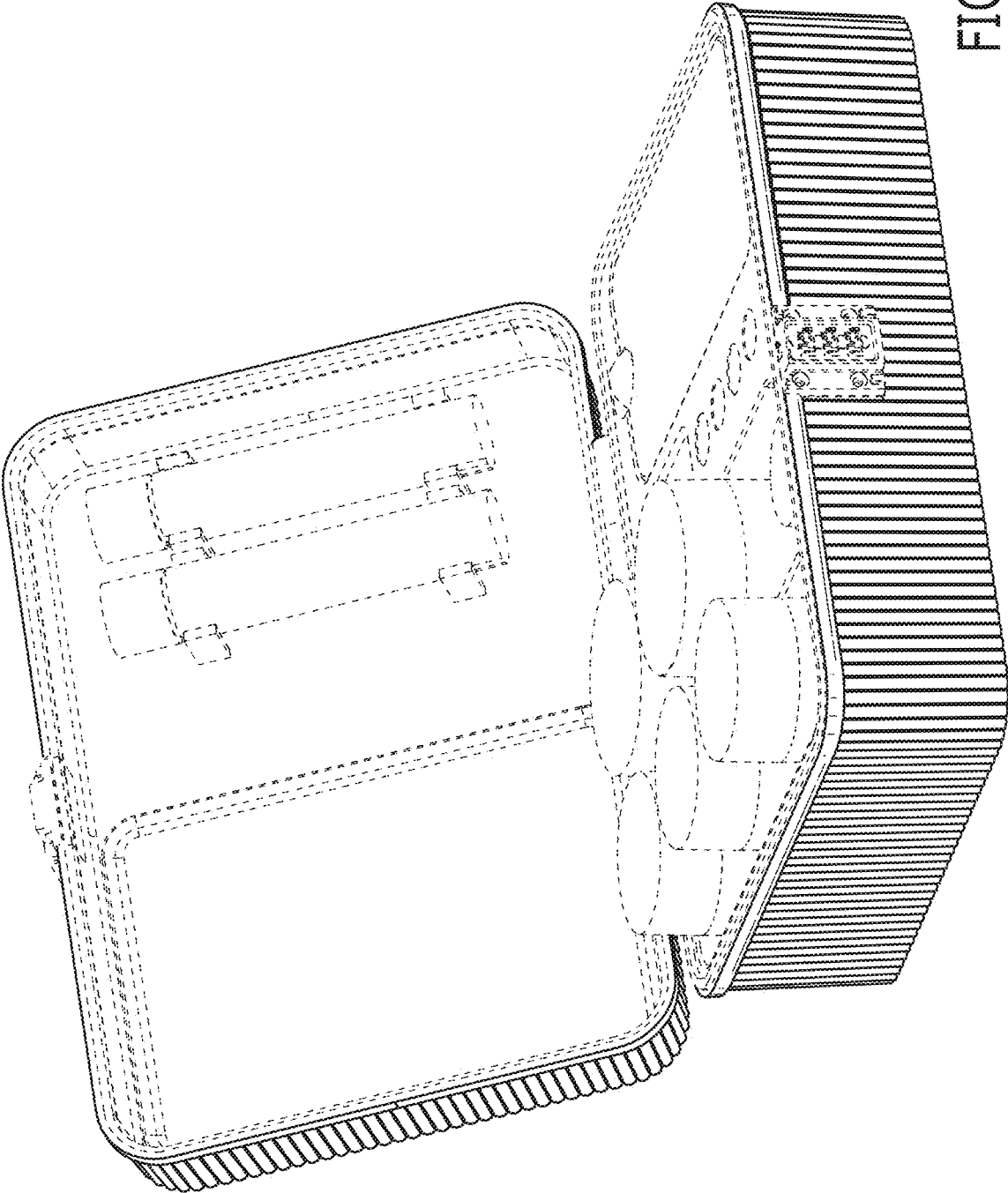

FIG. 6