



US00D741007S

(12) **United States Design Patent**
McNama

(10) **Patent No.:** **US D741,007 S**

(45) **Date of Patent:** **** Oct. 13, 2015**

(54) **REVERSIBLE HAIR BAND COVER**

Primary Examiner — Zenia Bennett

(71) Applicant: **Kathleen Yvonne McNama**, New Rochelle, NY (US)

(72) Inventor: **Kathleen Yvonne McNama**, New Rochelle, NY (US)

(**) Term: **14 Years**

(21) Appl. No.: **29/494,896**

(22) Filed: **Jun. 25, 2014**

(51) **LOC (10) Cl.** **28-03**

(52) **U.S. Cl.**
USPC **D28/41**

(58) **Field of Classification Search**
USPC D28/21-34, 39-43; 132/101, 126,
132/128-131, 144, 148, 219, 275-284;
D11/3-6; D2/871-875
CPC A45D 8/00
See application file for complete search history.

(56) **References Cited**

U.S. PATENT DOCUMENTS

1,626,433	A *	4/1927	Siner	132/273
2,402,795	A *	6/1946	Wipper et al.	2/155
2,795,232	A *	6/1957	Klein et al.	132/275
4,892,110	A *	1/1990	Harvie	132/273
D345,644	S *	4/1994	Harvie	D2/865
5,372,152	A *	12/1994	Dutch	132/246
5,799,672	A *	9/1998	Hansbury	132/273
8,757,176	B2 *	6/2014	Harvie	132/246

* cited by examiner

(57) **CLAIM**

The ornamental design for a reversible hair band cover, as shown and described.

DESCRIPTION

FIG. 1 is a perspective rear view of a reversible hair band cover;
 FIG. 2 is a rear elevation view of the reversible hair band cover;
 FIG. 3 is a front elevation view of the reversible hair band cover;
 FIG. 4 is a left side elevation view of the reversible hair band cover, the right side elevation view being a mirror image thereof;
 FIG. 5 is a top plan view of the reversible hair band cover;
 FIG. 6 is a bottom plan view of the reversible hair band cover;
 FIG. 7 is a perspective rear view of the reversible hair band cover, shown in a reversed mode;
 FIG. 8 is a rear elevation view of the reversible hair band cover, showing a portion of the hair band protruding from the reversible hair band cover; and,
 FIG. 9 is a perspective view of the reversible hair band cover, shown in a flat mode, when not in use on the hair band.
 The hair band is shown in broken lines for illustrative purposes only and forms no part of the claimed design. The portion of the second surface shown in stipple shading denotes a contrasting material and or color relative to the first surface.

1 Claim, 5 Drawing Sheets

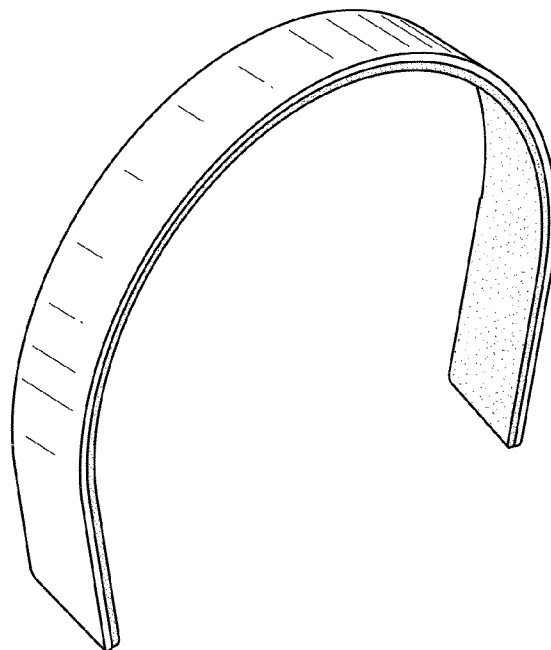

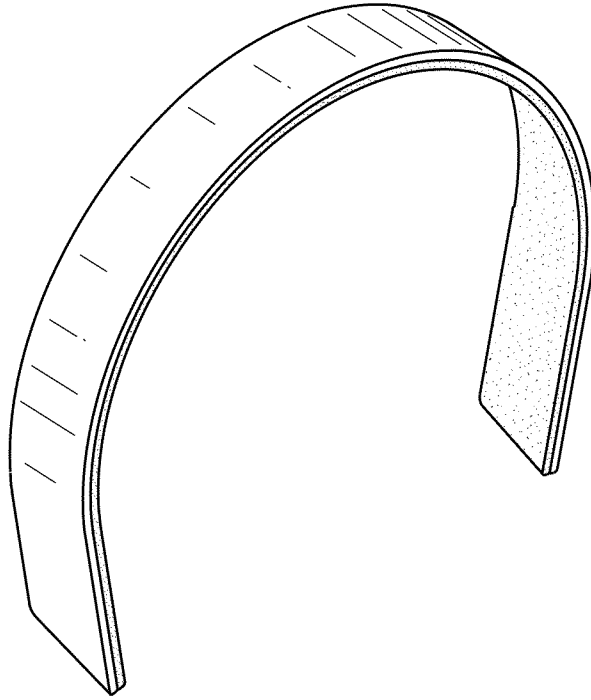

FIG. 1

FIG. 2

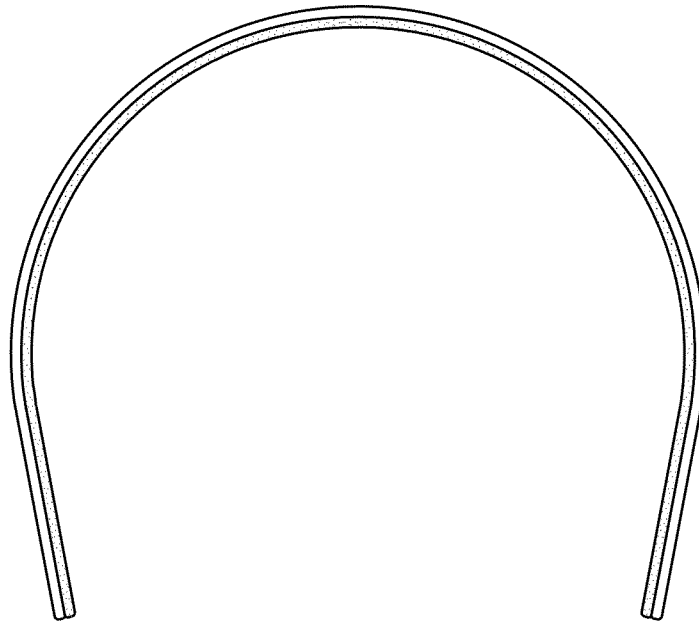

FIG. 3

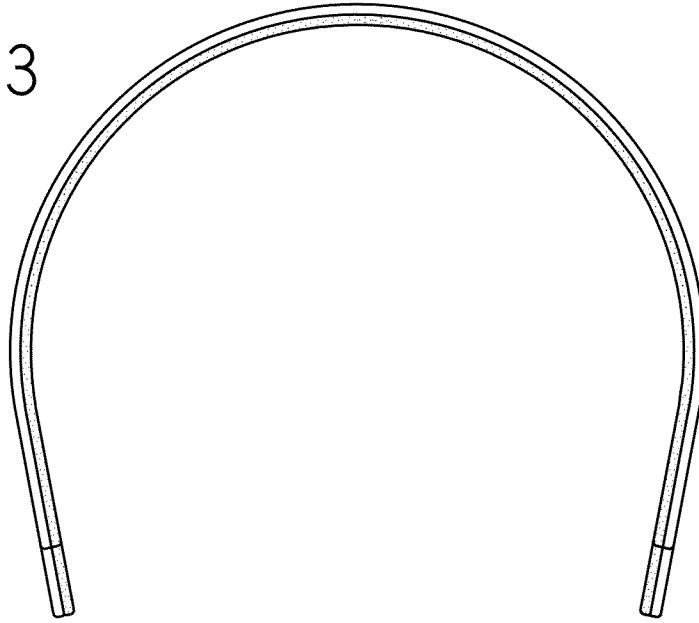
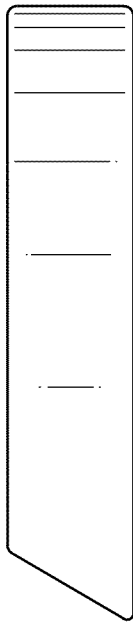

FIG. 4



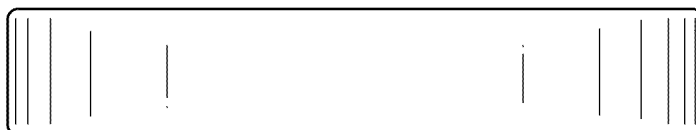

FIG. 5

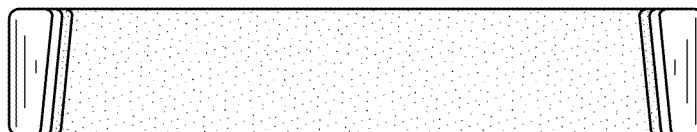

FIG. 6

FIG. 7

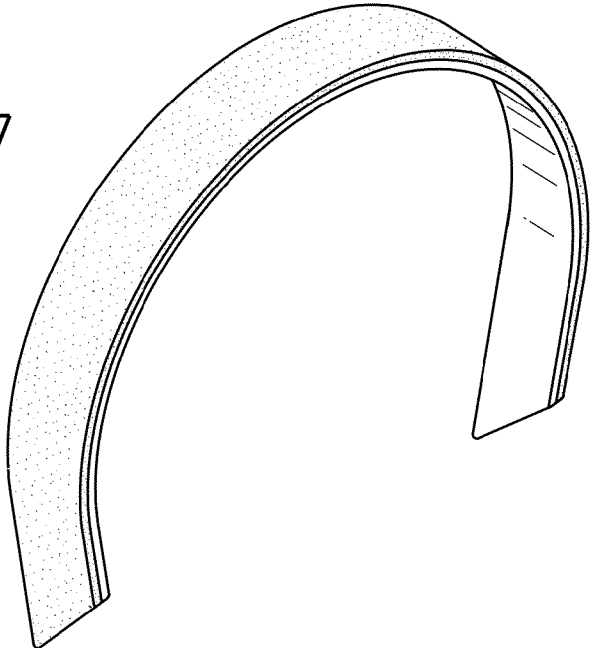
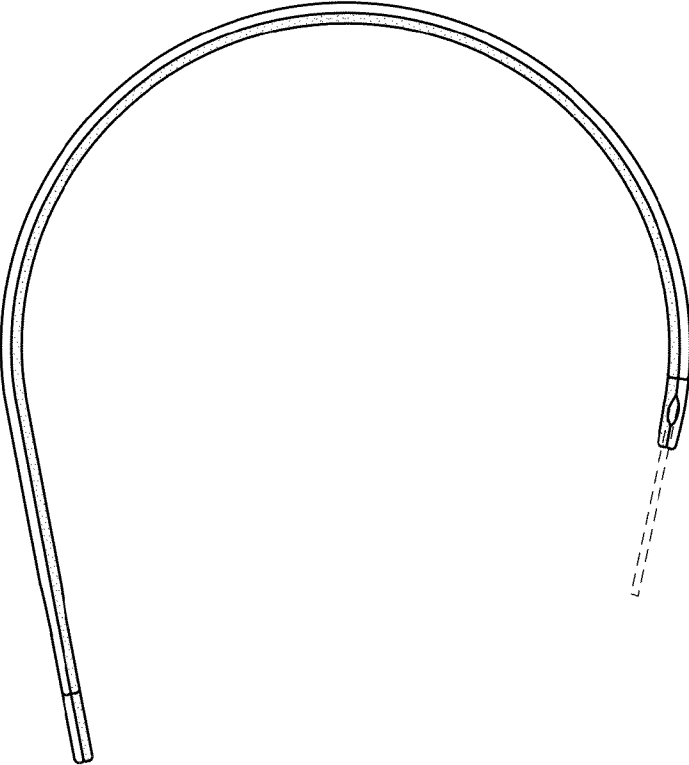

FIG. 8



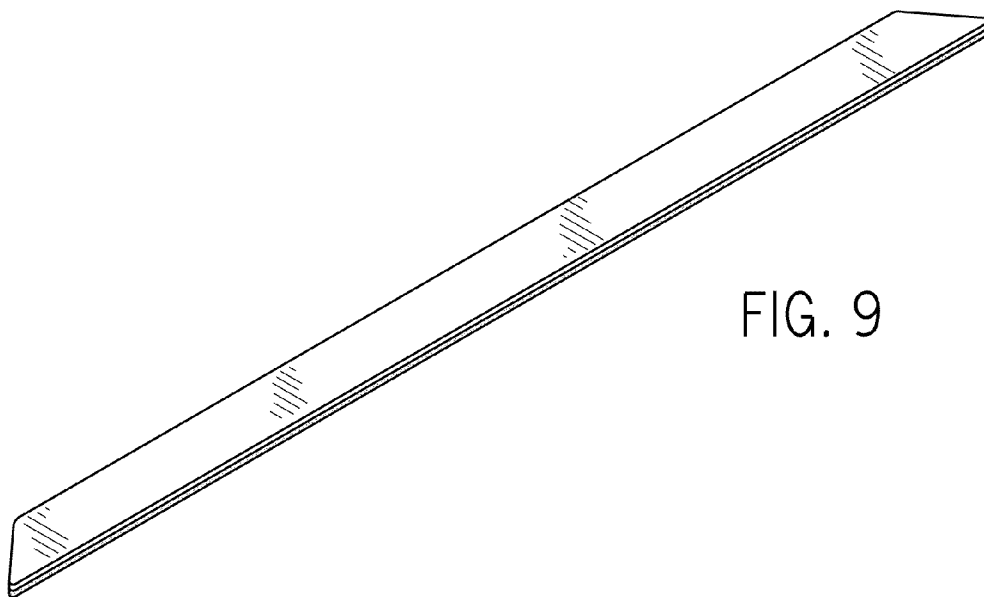

FIG. 9