



US00D754323S

(12) **United States Design Patent**
Ely

(10) **Patent No.:** **US D754,323 S**

(45) **Date of Patent:** **** Apr. 19, 2016**

(54) **HEARING DEVICE RETAINER**

FOREIGN PATENT DOCUMENTS

(71) Applicant: **3M INNOVATIVE PROPERTIES COMPANY**, St. Paul, MN (US)

CN 3332809 10/2003
CN 3475391 9/2005

(Continued)

(72) Inventor: **Jacob H. Ely**, Indianapolis, IN (US)

OTHER PUBLICATIONS

(73) Assignee: **3M Innovative Properties Company**, St. Paul, MN (US)

3M Occupational Health & Environmental Safety Division, "3M™ Combat Arms Earplugs," 2 pages, © 3M™ 2010.

(**) Term: **14 Years**

Primary Examiner — Richelle G Shelton

(21) Appl. No.: **29/482,289**

(57) **CLAIM**

The ornamental design for a hearing device retainer, as shown and described.

(22) Filed: **Feb. 17, 2014**

(51) **LOC (10) Cl.** **24-04**

(52) **U.S. Cl.**
USPC **D24/106**

(58) **Field of Classification Search**
USPC D24/106, 173, 174; D8/308; D14/205, D14/206, 223; D29/112
CPC ... A61F 11/08; A61F 11/12; A61F 2011/085; H04R 1/105; H04R 25/02
See application file for complete search history.

DESCRIPTION

FIG. 1 is a perspective view of a new design for a hearing device retainer;
FIG. 2 is a left side view thereof;
FIG. 3 is a right side view thereof;
FIG. 4 is a rear view thereof;
FIG. 5 is a front view thereof;
FIG. 6 is a top view thereof; and
FIG. 7 is a bottom view thereof;
FIG. 8 is a perspective view of the hearing device retainer in an alternate environment shown with a hearing device;
FIG. 9 is a left side view thereof;
FIG. 10 is a right side view thereof;
FIG. 11 is a rear view thereof;
FIG. 12 is a front view thereof;
FIG. 13 is a top view thereof; and,
FIG. 14 is a bottom view thereof.

The broken line showing of the remainder of the hearing device retainer and of a hearing device forms no part of the claimed design. The dash-dot-dot line represents the boundary of the claimed design and forms no part thereof. Shading is provided to illustrate contour only and is not an indication of texture or sheen.

(56) **References Cited**

U.S. PATENT DOCUMENTS

5,048,090 A	9/1991	Geers
D350,757 S	9/1994	Carpenter
D363,487 S	10/1995	Thurnau
D375,313 S	11/1996	Jensen
D377,796 S	2/1997	Hayashi
D383,757 S	9/1997	Dobruskin
D384,958 S	10/1997	Shudo
D388,093 S	12/1997	Frengley
D391,576 S	3/1998	Mullin
D402,661 S	12/1998	Hayashi
D403,327 S	12/1998	Landreth
D411,540 S	6/1999	Mavrakis
D419,564 S	1/2000	McDonald
D420,007 S	2/2000	Marshall

(Continued)

1 Claim, 6 Drawing Sheets

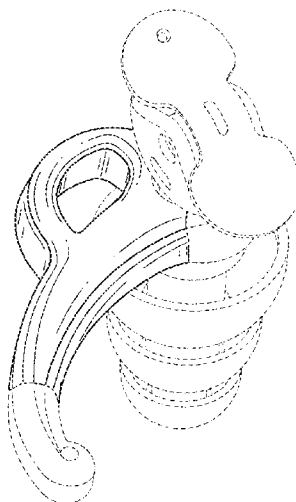

(56)

References Cited

U.S. PATENT DOCUMENTS

D421,755 S 3/2000 Pitel
 6,068,079 A 5/2000 Hamery
 6,070,693 A 6/2000 Hamery
 D427,994 S 7/2000 Pirelli
 D431,235 S 9/2000 Lyman
 6,148,821 A 11/2000 Falco
 D436,095 S 1/2001 Schmidt
 D449,295 S 10/2001 Smith
 D452,857 S 1/2002 Hong
 D455,732 S 4/2002 Skulley
 D460,436 S 7/2002 Bjorklund
 D464,943 S 10/2002 Lai
 D465,209 S 11/2002 Rath
 D468,721 S 1/2003 Nguyen
 D469,422 S 1/2003 Nguyen
 D469,755 S 2/2003 Hlas
 D470,121 S 2/2003 Nguyen
 D470,478 S 2/2003 Kohli
 D471,537 S 3/2003 Ham
 D472,888 S 4/2003 Rath
 D472,890 S * 4/2003 Suzuki D14/223
 D475,694 S 6/2003 Bey
 D477,821 S 7/2003 Bieltvedt
 D479,226 S 9/2003 Beauregard, Jr.
 D480,073 S 9/2003 Jensen
 D480,711 S 10/2003 Kuan
 D487,078 S 2/2004 Chen
 D498,227 S 11/2004 Dyer
 D500,999 S 1/2005 Dyer
 D501,196 S 1/2005 Dyer
 D504,673 S 5/2005 Dyer
 D508,911 S 8/2005 Sanders
 D510,931 S 10/2005 Weikel
 D512,049 S 11/2005 Yang
 D512,984 S 12/2005 Ham
 D521,492 S 5/2006 Ham
 D523,845 S 6/2006 Smith
 D533,867 S 12/2006 Koizumi
 D533,868 S 12/2006 Koizumi
 D537,812 S 3/2007 Erich
 D539,266 S 3/2007 Bentley
 D543,968 S 6/2007 Wong
 D550,655 S 9/2007 Falco
 D556,735 S 12/2007 Yeo
 D557,688 S 12/2007 Lee
 D562,808 S 2/2008 Gwee
 D572,241 S 7/2008 Gwee
 D573,137 S 7/2008 Polito
 D575,767 S 8/2008 Lee
 D575,772 S * 8/2008 Schultz et al. D14/223
 D576,155 S 9/2008 Wilson
 D576,156 S 9/2008 Wilson
 D576,610 S 9/2008 Johnson
 D577,009 S 9/2008 Wilson
 D579,444 S 10/2008 Ewert
 D585,429 S 1/2009 Dean
 D585,881 S 2/2009 Nam
 D589,152 S 3/2009 Champkins
 D593,075 S 5/2009 Williams
 D593,076 S 5/2009 Kung
 D593,077 S 5/2009 Williams
 D595,273 S 6/2009 Kim
 D597,084 S 7/2009 Gondo
 D598,469 S 8/2009 Harris, Jr.
 D599,329 S 9/2009 Champkins
 D603,379 S 11/2009 Harbeke
 D604,273 S 11/2009 Tamura
 D609,699 S 2/2010 Burnham
 D610,129 S 2/2010 Densho
 D611,933 S 3/2010 Burnham
 D617,780 S 6/2010 Jaakkola
 D618,669 S 6/2010 Johnson
 D619,124 S 7/2010 Clay
 D621,817 S 8/2010 Brickstad
 D622,265 S 8/2010 Rye

D622,694 S 8/2010 Lascelles
 D622,704 S 8/2010 Fahrendorff
 D624,529 S 9/2010 Huang
 D625,297 S 10/2010 Tseng
 D628,990 S 12/2010 Pedersen
 D629,397 S 12/2010 Hensen
 D630,621 S 1/2011 Pedersen
 D633,899 S 3/2011 Zheng
 D634,306 S 3/2011 Pedersen
 D635,559 S 4/2011 Rye
 D635,838 S * 4/2011 Shyu et al. D8/308
 D635,960 S 4/2011 Gondo
 D636,762 S 4/2011 Hensen
 D639,283 S 6/2011 Ozawa
 D640,670 S 6/2011 Rye
 D641,008 S 7/2011 Lee
 D641,011 S 7/2011 Gondo
 D643,418 S 8/2011 Lee
 D645,458 S 9/2011 Silvestri
 D647,514 S 10/2011 Wikel
 D647,877 S 11/2011 Son
 D648,328 S 11/2011 Morimoto
 D649,533 S 11/2011 Lee
 D653,243 S 1/2012 Katsumata
 D653,244 S 1/2012 Birger
 D654,057 S 2/2012 Burgett
 D655,693 S 3/2012 Silvestri
 D661,284 S 6/2012 Brandis
 D662,086 S 6/2012 Komiyama
 D662,088 S 6/2012 Brandis
 D662,915 S 7/2012 Halkosaari
 D664,124 S 7/2012 Smith
 D666,169 S 8/2012 Tucker
 8,249,287 B2 * 8/2012 Silvestri et al. 381/380
 D667,123 S 9/2012 Takemoto
 D667,124 S 9/2012 Takemoto
 D668,631 S 10/2012 Katsumata
 D668,632 S 10/2012 Enquist
 D669,057 S 10/2012 Zheng
 D672,043 S * 12/2012 Larsen D24/174
 D672,874 S 12/2012 Ishibashi
 D672,875 S 12/2012 Ishibashi
 D679,682 S 4/2013 Shimizu
 D681,602 S 5/2013 Koch
 D682,257 S 5/2013 Zheng
 D685,351 S 7/2013 Morimoto
 D685,768 S 7/2013 Mogili
 D687,021 S 7/2013 Yuen
 D693,326 S 11/2013 Takeno
 D693,792 S 11/2013 Seto
 8,625,834 B2 1/2014 Smith
 8,737,669 B2 * 5/2014 Monahan et al. 381/380
 2006/0177080 A1 * 8/2006 Smith 381/313
 2008/0085030 A1 4/2008 Smith
 2008/0181441 A1 7/2008 Smith
 2012/0057739 A1 3/2012 Smith

FOREIGN PATENT DOCUMENTS

CN 3597837 1/2007
 CN 301104736 1/2010
 CN 301139500 2/2010
 CN 301365125 10/2010
 CN 301759948 12/2011
 CN 301768831 12/2011
 EM 000915368-0006 5/2008
 EM 001202824-0004 4/2010
 EM 001282388-0027 9/2011
 EM 001982976-0002 5/2012
 EM 001982976-0003 5/2012
 EM 001982976-0005 5/2012
 EM 001982976-0007 5/2012
 GB 2052356 3/1996
 GB 2055470 8/1996
 GB 2073246 8/1998
 GB 2086330 12/1999
 GB 2103002 8/2001
 GB 3004998 7/2002
 GB 3005024 10/2002

(56)

References Cited

FOREIGN PATENT DOCUMENTS

GB	3006343	10/2002
JP	D1232492	3/2005
JP	D1412316	4/2011
JP	D1422431	9/2011
JP	D1431262	1/2012
JP	D1432304	1/2012

JP	D1432305	1/2012
JP	D1436556	3/2012
JP	D1437169	4/2012
JP	D1472400	6/2013
JP	D1479882	9/2013
KR	300482159	3/2008
KR	300619595	11/2011
RU	00083284	10/2012
WO	2011-075840	6/2011

* cited by examiner

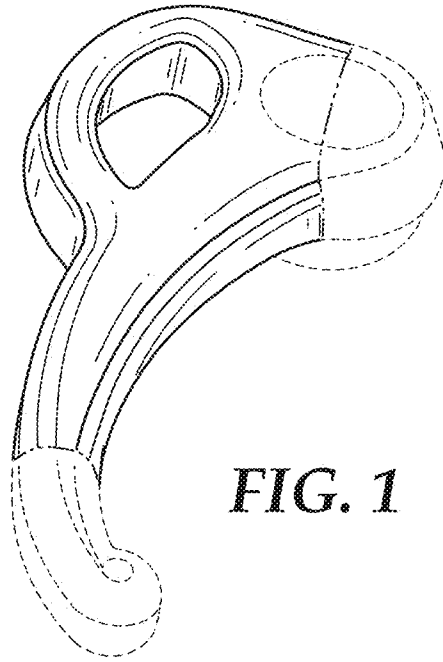

FIG. 1

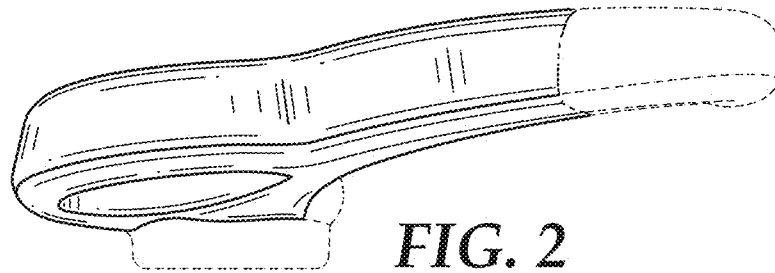

FIG. 2

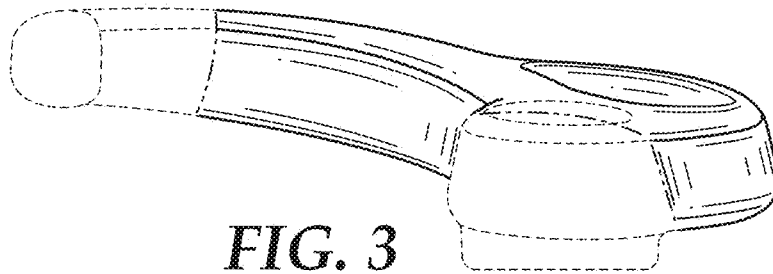

FIG. 3

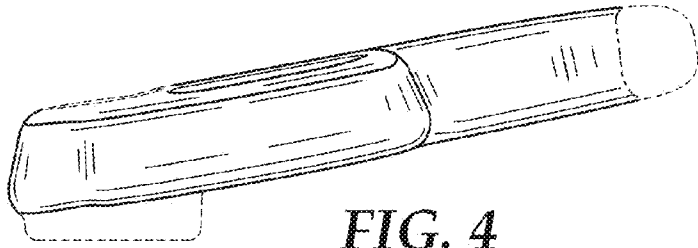

FIG. 4

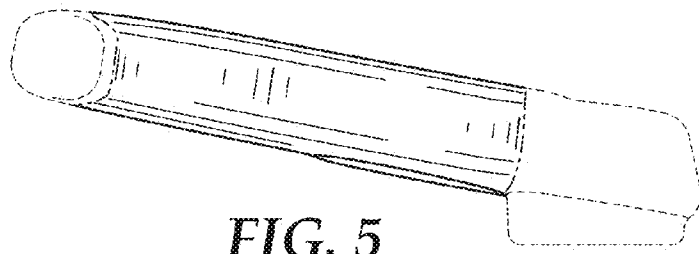

FIG. 5

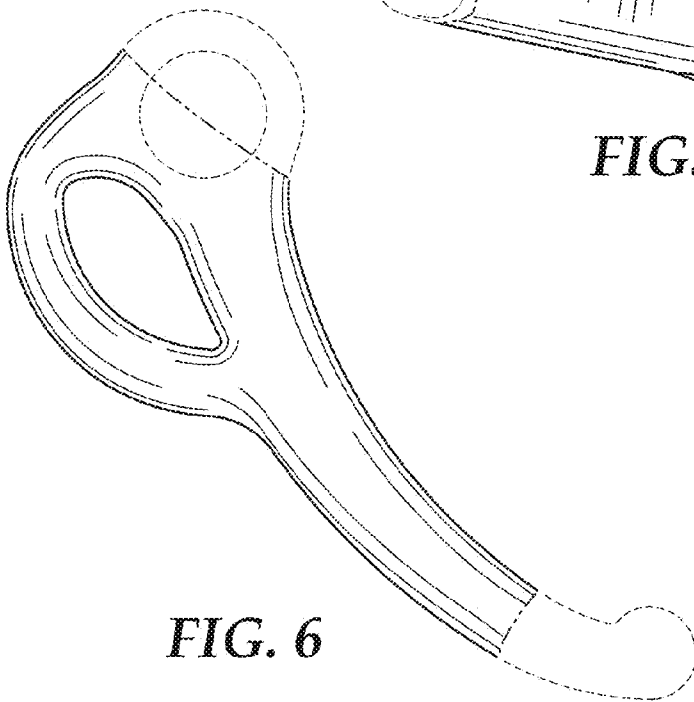

FIG. 6

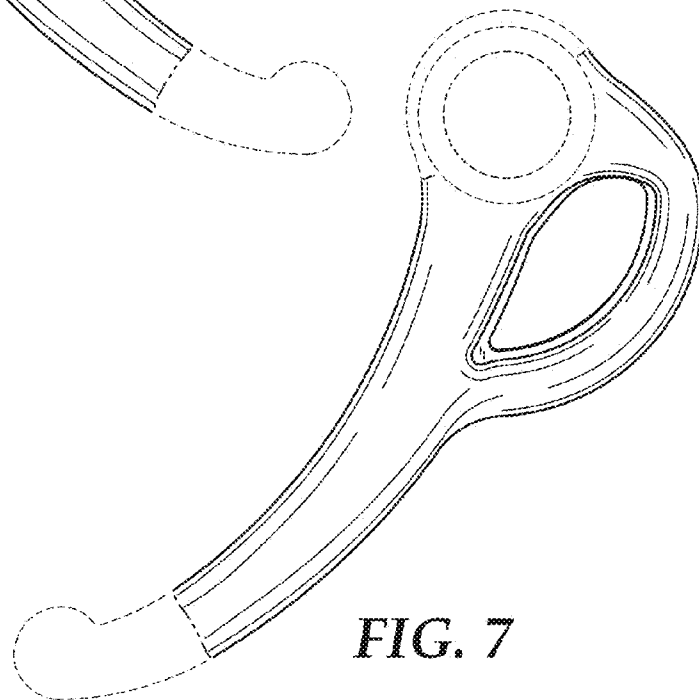

FIG. 7

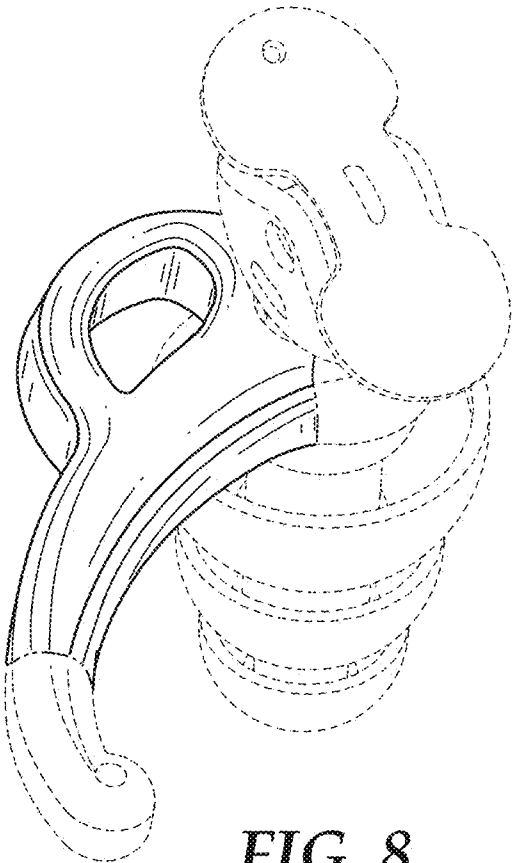
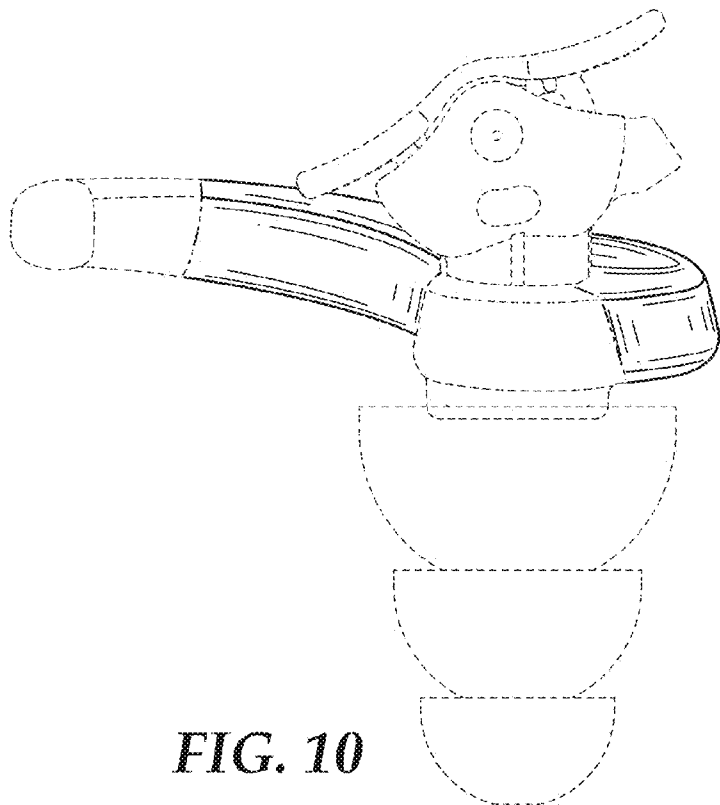
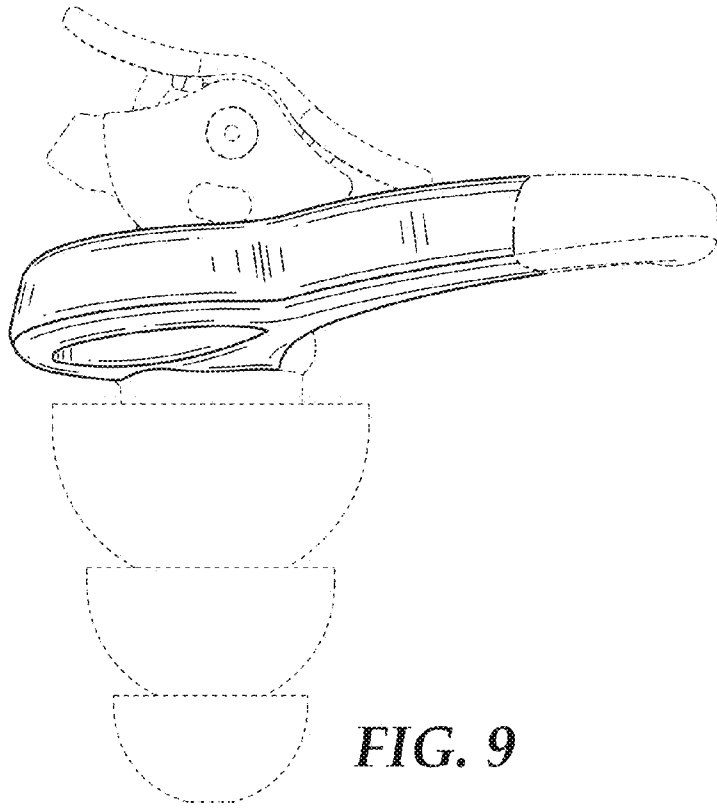
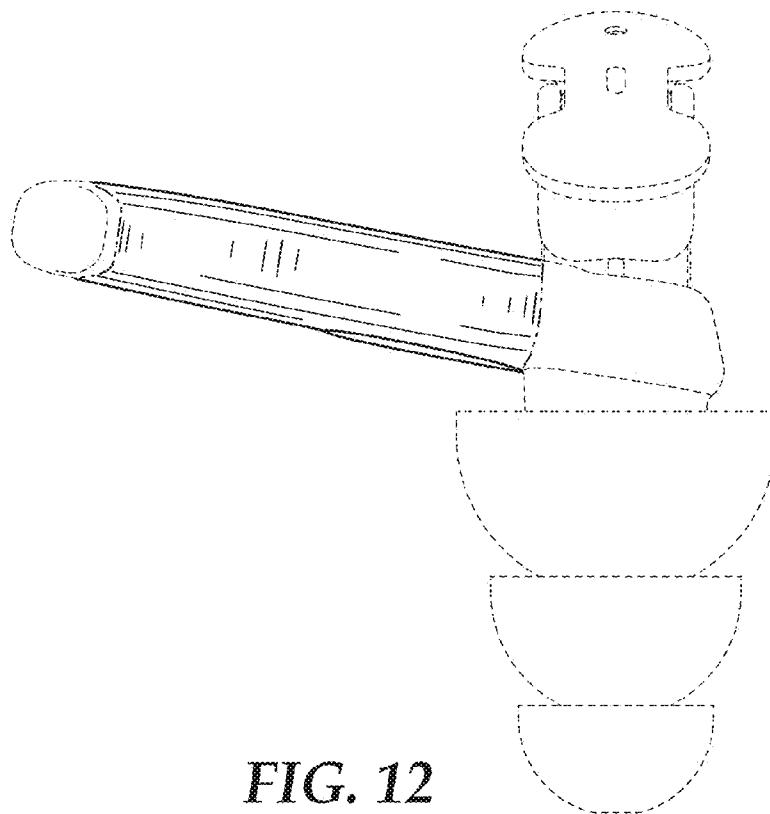
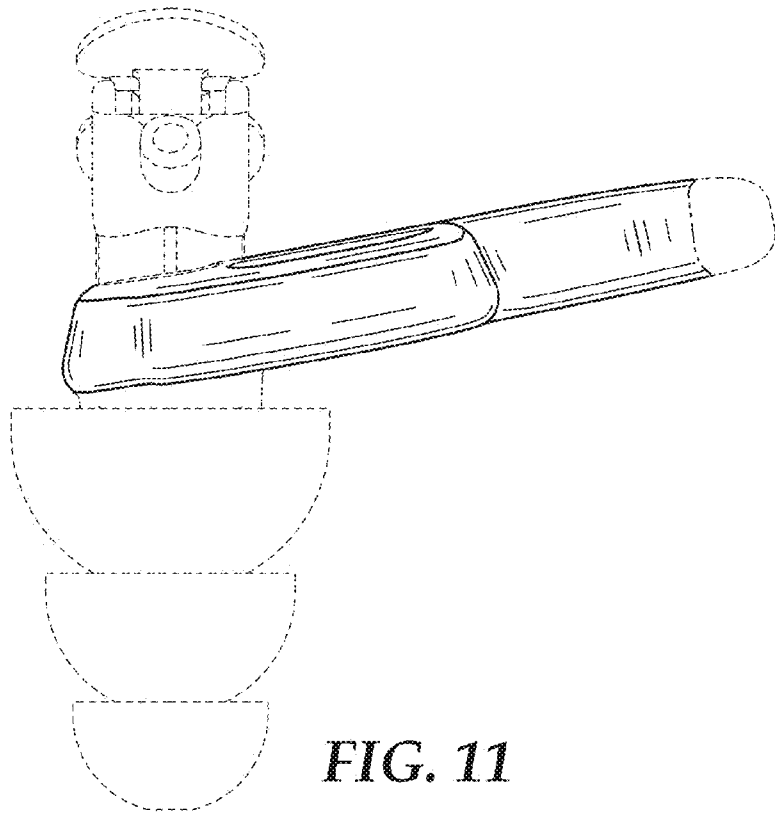

FIG. 8





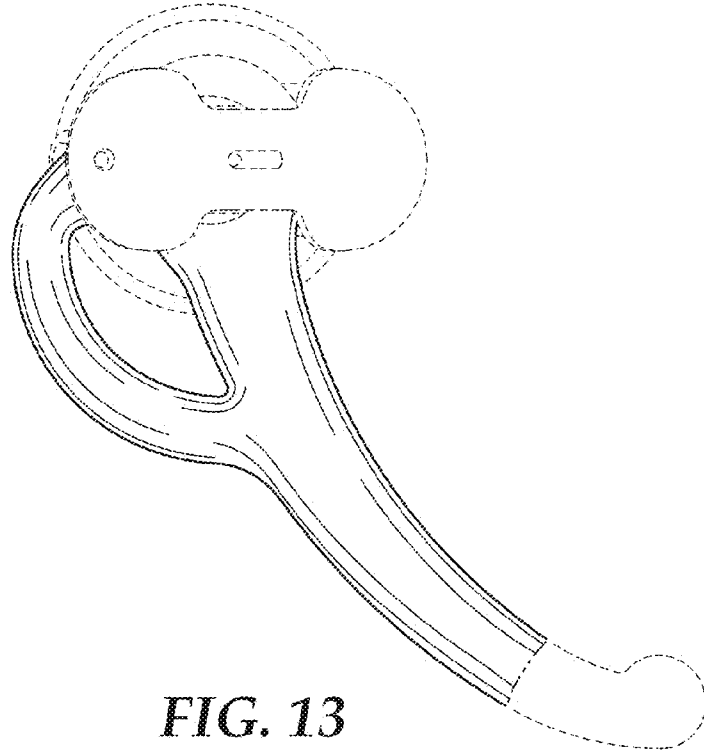

FIG. 13

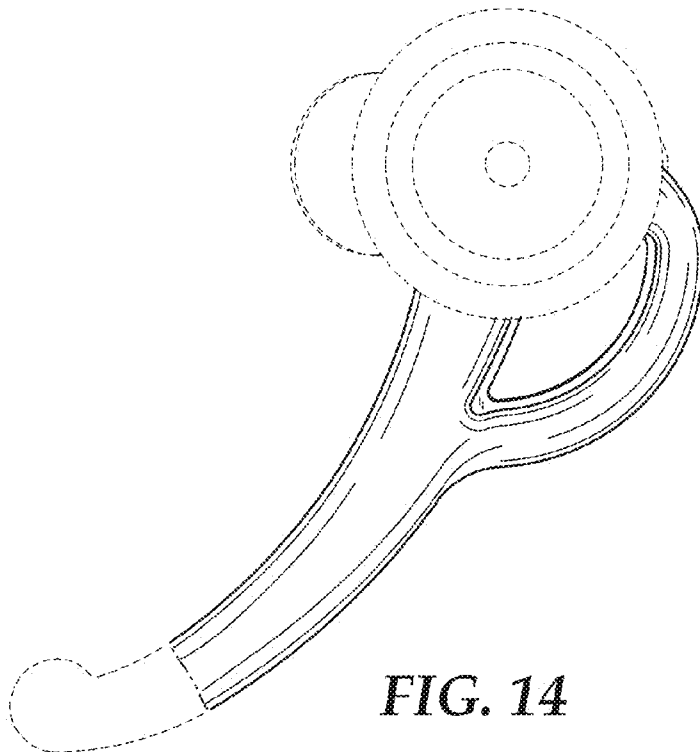

FIG. 14