

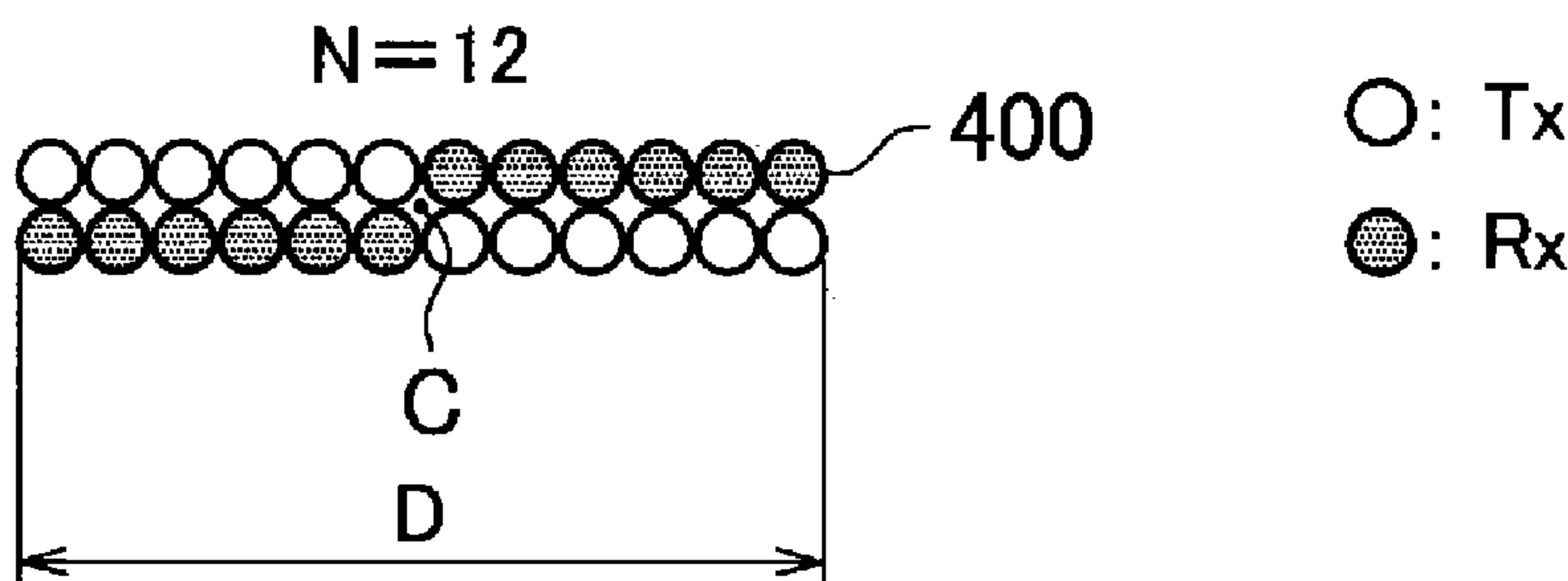

(86) Date de dépôt PCT/PCT Filing Date: 2015/12/15
 (87) Date publication PCT/PCT Publication Date: 2016/07/14
 (85) Entrée phase nationale/National Entry: 2017/06/22
 (86) N° demande PCT/PCT Application No.: JP 2015/085087
 (87) N° publication PCT/PCT Publication No.: 2016/111123
 (30) Priorité/Priority: 2015/01/07 (JP2015-001577)

(51) Cl.Int./Int.Cl. *G02B 6/43* (2006.01),
G02B 6/04 (2006.01), *G02B 6/36* (2006.01)
 (71) Demandeur/Applicant:
SONY CORPORATION, JP
 (72) Inventeurs/Inventors:
NAKAJIMA, YASUHISA, JP;
YAMAMOTO, MASANARI, JP
 (74) Agent: GOWLING WLG (CANADA) LLP

(54) Titre : CONNECTEUR OPTIQUE
 (54) Title: OPTICAL CONNECTOR



(57) **Abrégé/Abstract:**

An optical fiber connector according to the present invention is provided with a plurality of optical transmission paths, of which the end surface is arranged within a predetermined region and which transmit optical signals. The optical transmission paths, which correspond to transmission channels or reception channels, are arranged in point symmetry with respect to the center of the predetermined region. As a result of such a configuration, it is possible to connect even if the orientation of the optical connector changes.

ABSTRACT

An optical connector according to the present disclosure includes: optical transmission paths that have end faces aligned in a predetermined region, and transmit
5 optical signals. The optical transmission paths correspond to transmission channels or reception channels. The optical transmission paths of the transmission channels and the reception channels are arranged to have point symmetry about a center of the predetermined region. This configuration allows for a connection even if a direction of an optical connector is changed.

Description

Title of Invention

OPTICAL CONNECTOR

5

Technical Field

[0001]

The present disclosure relates to an optical connector.

10

Background Art

[0002]

Optical data transmission has been finding uses with a sharp increase in the amount of communication in recent years. The optical data transmission is, however, used chiefly for data transmission of infrastructure backbone systems, and data transmission between data servers, which transmit a large amount of data, but has yet to gain widespread use among consumers. Class 2 or class 3 for high output lasers in the safety standard (JIS C6802) for laser beams is therefore applied under the control of laser managers. The structures of devices prioritize only reliable connections to optical cables, and are difficult for general users to easily use.

20

[0003]

Meanwhile, users themselves can connect devices with no special instruments or techniques in electrical data transmission, which has already been common for connections of consumer devices. Moreover, in view of easy use for users, it is desirable to allow connectors to be inserted with either side facing up or down when connecting cables to devices.

25

[0004]

For example, Patent Literature 1 below describes a technique related to an optical connector that introduces light to an optical transmission path having an optical axis direction different from the optical axis direction from a light output terminal, and introduces the light to a light input terminal having an optical axis direction different from that of the optical transmission path.

30

[0005]

Further, Patent Literature 2 below describes the configuration of an optical connector that has two optical connection faces: an optical connection face that is connected in a straight line from an optical transmission path of an optical cable; and
 5 the other optical connection face that is vertical to the optical transmission path.

[0006]

Further, Patent Literature 3 below describes a configuration in which an optical connection is made on two faces relative to optical connectors, but an optical transmitting device and an optical receiving device have the directions of the optical
 10 connectors aligned.

Citation List

Patent Literature

[0007]

15	Patent Literature 1:	JP 2008-292962A
	Patent Literature 2:	JP 2007-240866A
	Patent Literature 3:	JP 2000-147333A

Disclosure of Invention

20 Technical Problem

[0008]

However, the techniques described in Patent Literatures above all define the polarity of the up and down direction of a connector uniquely, and accept no upside-down connections or connections in any other directions. Users therefore have to
 25 check the direction of a connector in making a connection, causing a problem with the decreased convenience of connections.

[0009]

It is therefore desired to allow devices that perform optical transmission to be connected to each other even if the direction of an optical connector is changed.

30

Solution to Problem

[0010]

According to the present disclosure, there is provided an optical connector including: optical transmission paths that have end faces aligned in a predetermined region, and transmit optical signals. The optical transmission paths correspond to
5 transmission channels or reception channels. The optical transmission paths of the transmission channels and the reception channels are arranged to have point symmetry about a center of the predetermined region.

Advantageous Effects of Invention

10 [0011]

As described above, according to the present disclosure, it is possible to connect devices that perform optical transmission to each other even if the direction of a connector is changed.

Note that the effects described above are not necessarily limitative. With or
15 in the place of the above effects, there may be achieved any one of the effects described in this specification or other effects that may be grasped from this specification.

Brief Description of Drawings

[0012]

20 [FIG. 1] FIG. 1 is a schematic diagram illustrating a configuration of an optical fiber system 1000 according to an embodiment of the present disclosure.

[FIG. 2] FIG. 2 is a schematic diagram illustrating an example of optical loss on a transmission path in the optical fiber system.

[FIG. 3] FIG. 3 is a conceptual diagram illustrating a relationship between a maximum
25 blocking time in an automatic power reduction function activated when a cable is cut off or an optical connector is disconnected and optical energy of a laser beam.

[FIG. 4] FIG. 4 is a schematic diagram illustrating a relationship between a light source diameter A , a visual angle α , and a measurement distance D .

[FIG. 5] FIG. 5 is a schematic diagram illustrating default values in “class 1” of a laser
30 beam obtained from Equation 1 for two arrangement examples of transmission channels Tx and reception channels Rx at an end of an optical connector 300.

[FIG. 6] FIG. 6 is a schematic diagram illustrating an arrangement example of optical fibers of transmission channels (Tx) and reception channels (Rx) of a connector unit including optical paths of twelve transmission channels and twelve reception channels, namely 24 channels in total.

5 [FIG. 7] FIG. 7 is a schematic diagram illustrating an example in which halves of the transmission channels (Tx) are concentrated and arranged in an upper left row and a lower right row.

[FIG. 8] FIG. 8 is a schematic diagram illustrating an example in which an even number of transmission channels (Tx) and an even number of reception channels (Rx) are alternately arranged in the horizontal direction to make a staggered arrangement in the upper row and the lower row.

10 [FIG. 9] FIG. 9 is a schematic diagram illustrating an example in which the transmission channels (Tx) and the reception channels (Rx) are alternately arranged in the horizontal direction, and same channels are arranged in upper and lower rows in a vertical direction.

[FIG. 10] FIG. 10 is a schematic diagram illustrating an example in which, in a case where the transmission channels (Tx) and the reception channels (Rx) are alternately arranged in the horizontal direction, and same channels are arranged in the upper and lower rows in the vertical direction, different channels are arranged only in outermost upper and lower rows.

20 [FIG. 11] FIG. 11 is a schematic diagram illustrating a modification of terminal alignments of connector units 102 and 202 according to the present embodiment.

Mode(s) for Carrying Out the Invention

25 [0013]

Hereinafter, (a) preferred embodiment(s) of the present disclosure will be described in detail with reference to the appended drawings. In this specification and the appended drawings, structural elements that have substantially the same function and structure are denoted with the same reference numerals, and repeated explanation of these structural elements is omitted.

30 [0014]

1. Configuration of Optical Fiber System
 2. Optical Loss on Transmission Path
 3. Safety Standards for Laser Products
 4. Channel Arrangement of Connector Unit
 - 5 5. Modification of the Present Embodiment
- [0015]

1. Configuration of Optical Fiber System

First, the configuration of an optical fiber system 1000 according to an embodiment of the present disclosure will be described with reference to FIG. 1. As illustrated in FIG. 1, the system according to the present embodiment includes an optical transmitting and receiving device 100 and an optical transmitting and receiving device 200. The optical transmitting and receiving device 100 includes a connector unit 102, and the optical transmitting and receiving device 200 includes a connector unit 202. The connector unit 102 of the optical transmitting and receiving device 100 is connected to the connector unit 202 of the optical transmitting and receiving device 200 by an optical cable 300.

[0016]

Further, the optical transmitting and receiving device 100 includes a light emitting unit 110 for optical data, a lens 120, a light emitting end 130, a light receiving end 140, a lens 150, and a light receiving unit 160 for optical data. Similarly, the optical transmitting and receiving device 200 includes a light receiving end 210, a lens 220, a light receiving unit 230, a light emitting end 240, a lens 250, and a light emitting unit 260 for optical data.

[0017]

Although FIG. 1 illustrates that the optical transmitting and receiving device 100 and the optical transmitting and receiving device 200 each include a single light emitting unit, a single lens, and a single light emitting end for the optical cable 300 including a single optical transmission path, the optical cable 300 includes multiple optical transmission paths (optical fibers 400). The optical transmitting and receiving device 100 and the optical transmitting and receiving device 200 therefore include multiple light emitting units, multiple lenses, and multiple light emitting ends

in accordance with the number of optical transmission paths (the number of channels). Similarly, FIG. 1 illustrates that the optical transmitting and receiving device 100 and the optical transmitting and receiving device 200 each include a single light receiving end, a single lens, and a single light receiving unit for the optical cable 300 including
5 a single optical transmission path, the optical cable 300 includes multiple optical transmission paths. The optical transmitting and receiving device 100 and the optical transmitting and receiving device 200 therefore include multiple light receiving ends, multiple lenses, and multiple light receiving units in accordance with the number of optical transmission paths.

10 [0018]

Further, the lens 120 may be arranged at the position of the light emitting end 130, and the lens 250 may be arranged at the position of the light emitting end 240 in FIG. 1. The light emitting end 130 and the light emitting end 240 each represent an interface on which light is emitted toward the connector units 102 and 202. Further,
15 the lens 150 may be arranged at the position of the light receiving end 140, and the lens 220 may be arranged at the position of the light receiving end 210. The light receiving end 140 and the light receiving end 210 each represent an interface on which light from the connector units 102 and 202 is received.

[0019]

20 2. Optical Loss on Transmission Path

FIG. 2 illustrates an example of optical loss on a transmission path (the light emitting unit 110 → the lens 120 → the light emitting end 130 → the optical cable 300 → the light receiving end 210 → the lens 220 → the light receiving unit 230) in the optical fiber system 1000. The optical energy in the light emitting unit 110 for optical
25 data is reduced in the lens unit 120 and the light emitting end 130 of the optical transmitting and receiving device 100. Moreover, the optical energy is also reduced in the optical cable 300 in proportion to the length thereof. Moreover, the optical energy is also reduced in the light receiving end 210 and the lens 220 of the optical transmitting and receiving device 200, and the reduced energy reaching the light
30 receiving unit 230 undergoes photoelectric conversion to generate desired data signals. Further, the same applies to the optical loss on a transmission path which arrives at the

optical transmitting and receiving device 100 from the optical transmitting and receiving device 200 via the optical cable 300.

[0020]

It is desirable that the bit error rates (BER) of video and audio data and other data transmitted in an optical cable system be less than or equal to 10^{-10} to 10^{-12} . To allow the light receiving unit 230 of the optical transmitting and receiving device 200 to have optical energy with a margin exceeding the minimum value of optical energy which satisfies this BER value, the optical energy in the light emitting unit 110 of the optical transmitting and receiving device 100 has to be increased.

10 [0021]

Cases are, however, assumed where the optical cable 300 is unplugged from the connector unit 102 of the optical transmitting and receiving device 100 and the connector unit 202 of the optical transmitting and receiving device 200, and the optical cable 300 itself is cut off. There is no denying the possibility that an increase in the optical energy in the light emitting unit 110 leads to damage to the human body, especially the retinas of eyeballs from the optical energy in such a case.

[0022]

3. Safety Standards for Laser Products

“JIS C6802: Safety Standard for Laser Products” and “JIS C6803: Safety of Laser Products — Safety of Optical Fiber Communication System” are then created as laser safety standards for the purpose of preventing laser products from damaging users. To show the hazard degrees of devices in operation which are each equipped with a laser beam source, this JIS C6802 defines seven “classes” that are decided in accordance with the laser radiation exposure levels of the devices used alone.

25 [0023]

The optical fiber systems for consumer use have to fall within “class 1” (hazard level 1) or “class 1M” (hazard level 1M) among these “classes.” The hazard degree of “class 1” is a level at which the retinas are not damaged even if laser beams are viewed for 100 seconds with no blinks. “Class 1M” is the same as “class 1,” but requires a warning to be displayed that laser products can pose a hazard in a case where auxiliary optics such as loupes are used.

30

[0024]

The restricted output value of optical energy in each class is subdivided in accordance with the wavelength of a laser beam and the maximum blocking time of a laser beam. FIG. 3 is a schematic diagram illustrating the relationship between the maximum blocking time in an automatic power reduction function (which will be referred to as APR function) activated when a cable is cut off or an optical connector is disconnected and the optical energy of a laser beam.

[0025]

Here, the automatic power reduction function is a function of reducing an optical output more within the maximum blocking time than within the normal data transmission period in a case where a cable is cut off or an optical connector is disconnected. With this function, the standards (JIS C6803 and IEC60825) permit data transmission at a higher optical output than that of class 1.

[0026]

FIG. 3 illustrates a case 1 of the APR function with a shorter maximum blocking time, and a case 2 of the APR function with a longer maximum blocking time than that of the case 1. Class 1 limits an optical output within the normal data transmission period to P_1 or less. In each of these case 1 and case 2, the power of light emitted to the outside world is defined to have a certain value or less in a case a cable is cut off or an optical connector is disconnected at time t_0 . The optical outputs are lowered to P_4 after the maximum blocking times in both of the case 1 and case 2. A maximum blocking time T_1 of the case 1 is set shorter than a maximum blocking time T_2 of the case 2. If the power of light emitted to the outside world at the time t_0 or later is lowered to the certain value or less, the case 1 having the shorter maximum blocking time T_1 can have a greater optical output within the normal data transmission time than that of the case 2 having the longer maximum blocking time T_1 .

[0027]

It is possible in the case 1 to increase an output P_3 of a laser beam within the normal data transmission period because the maximum blocking time T_1 is shorter. A large margin can be then obtained for satisfying the above-described BER value. Meanwhile, considerable costs are necessary to construct a circuit and the like for

realizing the shorter maximum blocking time T1 and sufficiently reducing the output of a laser beam within the time.

[0028]

Further, it is necessary in the case 2 to decrease an output P2 of a laser beam
 5 within the normal data transmission period because the maximum blocking time T2 is longer. The margin for satisfying the above-described BER value is also smaller. Meanwhile, fewer costs are needed by a circuit and the like for reducing a laser beam output within the maximum blocking time T2.

[0029]

10 Further, the default value of the output of a laser beam (an accessible emission limit (which will be referred to as AEL)) in “class 1” and “class 1M” is calculated in Equation 1 below in a case of an optical wavelength of 700 nm to 1050 nm and an extended source. Additionally, Equation 2 to Equation 4 are the calculation formulas of C₄, C₆, and T₂ in Equation 1.

15 [0030]

$$P = 7 * 10^{-4} * C_4 * C_6 * T_2^{-0.25} \text{ (W) --- (Equation 1)}$$

$$C_4 = 10^{0.002(\lambda-700)} \text{ --- (Equation 2)}$$

$$C_6 = \alpha/0.0015 \text{ --- (Equation 3)}$$

$$T_2 = 10 \times 10^{[(\alpha-0.0015)/98.5]} \text{ --- (Equation 4)}$$

20 [0031]

Additionally, λ represents the optical wavelength of a light source used for transmission in Equation 1. Further, as illustrated in FIG. 4, A represents a light source diameter that serves as the light emitting end face dimension of the optical connector 300, and α represents the visual angle decided on the basis of a measurement
 25 distance D (70 mm/100 mm/2000 mm) and the light source diameter A.

[0032]

According to Equation 1, an increase in the output P of a laser beam depends on the length of the wavelength λ and the light source diameter A. If the wavelength is set as a constant, it is the most efficient to increase the light source diameter. Here,
 30 in a case where light sources are distributed and arranged, the light source diameter A is the average value of the light sources in the vertical direction and the light sources

in the horizontal direction.

[0033]

FIG. 5 is a schematic diagram illustrating default values in “class 1” of a laser beam obtained from Equation 1 for two arrangement examples of transmission channels Tx and reception channels Rx at an end of the optical connector 300. Here is shown as an example a case where optical fiber transmission paths are assumed that have an optical wavelength of 850 nm, an optical path diameter of 0.18 mm, 12 transmission channels, 12 reception channels, an optical path length of 100 mm, and a blocking time of 0.01 seconds, and the connector unit 102 and the connector unit 202 have transmission channels (Tx) and reception channels (Rx) aligned at a pitch of 0.25 mm in the horizontal direction and at a pitch of 1 mm in the vertical direction. The optical transmission paths are not limited to the optical fibers 400, but may also be differently configured to transmit light.

[0034]

Further, a case where the measurement distance D is equal to 100 mm is shown. The case of (1) where the transmission channels (Tx) are concentrated at the center, and the case of (2) where the transmission channels (Tx) are distributed in the horizontal direction are shown as disposition examples of the transmission channels Tx and the reception channels Rx.

[0035]

In FIG. 5, the optical fibers 400 included in the transmission channels (Tx) and the reception channels (Rx) are made by covering a glass material transmitting light with a resin film. As an example, the optical fibers 400 each have an outermost circumferential diameter of 0.25 mm, and arranged to bring the outermost films into close contact with each other in the horizontal direction, thereby being aligned at a pitch of 0.25 mm. Additionally, a pitch of 1 mm is assumed in the vertical direction, but the optical fibers 400 may also be aligned at a pitch of 0.25 mm in the vertical direction.

[0036]

As described above, the light source diameter A is the average value of the light sources in the vertical direction and the light sources in the horizontal direction

in a case where light sources are distributed and arranged. Accordingly, distributing the transmission channels (Tx) makes the light source diameter A and the visual angle α larger, and then can increase the optical output.

[0037]

5 As illustrated in FIG. 5, the case shown in (2) where the transmission channels (Tx) are distributed in the horizontal direction therefore makes the light source diameter A larger, and then can increase the output (default value) of a laser beam. This can increase the margin illustrated in FIG. 2, and allow for favorable transmission. Specifically, the case of (2) where the transmission channels (Tx) are distributed in the
10 horizontal direction leads to a laser beam output of (0.6 mW) if the above-described condition is applied to Equation 1. Meanwhile, the case of (1) where the transmission channels (Tx) are concentrated at the center leads to a laser beam output of (0.4 mW). Further, the case of (2) where the transmission channels (Tx) are distributed in the horizontal direction leads to a maximum output of (3.7 mW) within a data transmission
15 period in a case of a maximum blocking time of 0.01 [sec]. Meanwhile, the case of (1) where the transmission channels (Tx) are concentrated at the center leads to (2.5mW).

[0038]

The output is increased by distributing the transmission channels (Tx) in the
20 horizontal direction as the arrangement of the optical cable of the connector units 102 and 202 on the basis of the above-described result in the present embodiment. This can increase the margin illustrated in FIG. 2, and allow for favorable transmission. Further, the use of the APR function allows for an increase in the output of a laser beam within the normal data transmission period, and makes it possible to obtain a
25 further larger margin for satisfying the BER value.

[0039]

4. Channel Arrangement of Connector Unit

FIG. 6 illustrates an arrangement example of the optical fibers 400 of the transmission channels (Tx) and the reception channels (Rx) of the connector unit 102
30 and the connector unit 202 including optical paths of twelve transmission channels and twelve reception channels, namely 24 channels in total. Connectors for consumer

use are required to be small in size because the connectors are mounted on devices such as mobile terminals. In the arrangement example, the thickness in the vertical direction is decreased as much as possible by aligning twelve columns ($N = 12$) in the horizontal direction and two rows ($M = 2$) in the vertical direction as a terminal alignment of 24 channels in total. Further, in this arrangement example, the sizes of the connector units 102 and 202 are decreased as much as possible by bringing the respective outermost films of the optical fibers 400 into contact with each other. Here, N represents the number of terminals (the number of optical fibers 400) in the horizontal direction, and M represents the number of terminals (the number of optical fibers 400) in the vertical direction.

[0040]

In such an alignment, the transmission channels (Tx) and the reception channels (Rx) are arranged in point symmetry in a predetermined region in which the transmission channels (Tx) and the reception channels (Rx) are arranged to further free the up and down insertion direction in the vertical direction. This allows for a connection even in a case where the optical cable 300 is inserted to the connector units 102 and 202 upside down (rotated and inserted by 180 degrees). Further, as described above, to obtain the maximum output of a laser beam source in Equation 1, it is desirable to distribute the transmission channels (Tx) so as to increase the arrangement length of the transmission channels (Tx) in the horizontal direction.

[0041]

FIG. 6 illustrates a case where the transmission channels (Tx) are concentrated at the center in a case where the number N of terminals in the horizontal direction is set as an even number ($= 12$). As described above, the output increases as the arrangement length of the transmission channels (Tx) in the horizontal direction is increased. In the arrangement example illustrated in FIG. 6, the transmission channels (Tx) has a minimum arrangement length D in the horizontal direction in an arrangement in which N is equal to 12 and M is equal to 2. The transmission channels (Tx) then have the lowest output in the arrangement.

[0042]

In view of the above-described condition, the optical fibers 400 of the

transmission channels (Tx) are aligned in point symmetry in FIGS. 7 to 10 in a case where the number of terminals in the horizontal direction is an even number ($N = 12$) (FIGS. 7 and 8) and in a case where the number of terminals in the horizontal direction is an odd number ($N = 13$) (FIGS. 9 and 10). FIGS. 7 to 10 all illustrate an arrangement in which the transmission channels (Tx) has point symmetric about a center point C in the figure, and the transmission channels (Tx) have the maximum alignment length D in the horizontal direction.

[0043]

FIG. 7 illustrates an example in which the halves of the transmission channels (Tx) are concentrated and arranged in an upper left row and a lower right row. FIG. 8 illustrates an example in which an even number of transmission channels (Tx) and an even number of reception channels (Rx) are alternately arranged in the horizontal direction to make a staggered arrangement in the upper row and the lower row. FIGS. 7 and 8 have the same alignment length D in the horizontal direction, and the equivalent optical output can be thus obtained.

[0044]

FIG. 9 illustrates an example in which the transmission channels (Tx) and the reception channels (Rx) are alternately arranged in the horizontal direction, and the same channels are arranged in upper and lower rows in the vertical direction. In this case, it is also possible to secure the maximum alignment length D in the horizontal direction. In the case of FIG. 9, the number of terminals in the horizontal direction is an odd number, and the transmission channels (Tx) that are two channels more than a necessary number of channels (twelve channels in this case) are arranged. The arrangement length D of the transmission channels is then greater than those of the cases of FIGS. 7 and 8. In the case of FIG. 9, in a case where the alignment of the transmission channels (Tx) is exchanged with the alignment of the reception channels (Rx), the transmission channels (Tx) and the reception channels (Rx) can be similarly arranged. However, in this case, the arrangement length D of the transmission channels (Tx) is slightly less than that of the case of FIG. 9.

[0045]

FIG. 10 illustrates an example in which, in a case where the transmission

channels (Tx) and the reception channels (Rx) are alternately arranged in the horizontal direction, and the same channels are arranged in the upper and lower rows in the vertical direction, different channels are arranged only in outermost upper and lower rows. In the case of FIG. 10, the reception channels that are two channels more than
5 a necessary number of channels (twelve channels in this case) are arranged. The arrangement length D of the transmission channels (Tx) is then greater than those of the cases of FIGS. 7 and 8.

[0046]

Additionally, in the alignment in which N is equal to 12 or N is equal to 13,
10 and M is equal to 2, the arrangement examples illustrated in FIGS. 7 to 10 allow the transmission channels (Tx) to have the greatest arrangement length D. It is possible to increase the optical output more reliably than the arrangement illustrated in FIG. 6 as long as the alignment has the greater arrangement length D than that of FIG. 6.

[0047]

15 According to the present embodiment, a user can thus connect the optical transmitting and receiving device 100 to the optical transmitting and receiving device 200 without paying any attention to the up and down direction of the optical connector units 102 and 202. Further, according to the present embodiment, it is possible to increase the output level (default value in the laser safety standard) of a laser beam
20 source. Accordingly, it is possible to obtain a large margin for the bit error rate of transmission signals, and then improve the transmission quality. It is therefore possible to considerably improve the convenience of a user.

[0048]

5. Modification of the Present Embodiment

25 FIG. 11 illustrates a modification of terminal alignments of connector units 102 and 202 according to the present embodiment. Uncompressed video and audio data is, for example, assumed as data transmitted from the optical transmitting and receiving device 100 to the optical transmitting and receiving device 200 in the optical fiber system 1000 of FIG. 1. In this case, the transmission rate in the return channel
30 from the optical transmitting and receiving device 200 to the optical transmitting and receiving device 100 is assumed for data transmission having an extremely lower

transmission rate than that of the above-described uncompressed video and audio data. The terminal alignment as illustrated in FIG. 11 can be realized in such a system that has a non-target transmission rate depending on the transmission direction. Here, the alignment illustrated in the left part of FIG. 11 is similar to that of FIG. 6. The
5 alignment illustrated in the right part of FIG. 11 has the transmission channels (Tx) arranged at both ends as compared with the alignment of FIG. 6. At this time, the transmission channels (Tx) of the optical transmitting and receiving device 100 arranged at both ends of the terminals may increase the output of a laser beam source and secure the margin of the above-described uncompressed video and audio data, and
10 the output of a laser beam source for the return channels of the optical transmitting and receiving device 200 corresponding to the reception channels (Rx) arranged at the center of the terminals may be low.

[0049]

As described above, according to the present embodiment, a user can connect
15 the optical transmitting and receiving device 100 to the optical transmitting and receiving device 200 without paying any attention to the up and down direction of the optical connector units 102 and 202. Further, according to the present embodiment, it is possible to increase the output level (default value in the laser safety standard) of a laser beam source. Accordingly, it is possible to obtain a large margin for the bit
20 error rate of transmission signals, and then improve the transmission quality. It is therefore possible to considerably improve the convenience of a user. It is thus possible to connect devices that perform optical transmission even if the direction of a connector is changed, and provide a terminal arrangement of a connector terminal capable of improving the transmission quality within safety standard restriction values
25 required of a laser beam.

[0050]

The preferred embodiment(s) of the present disclosure has/have been described above with reference to the accompanying drawings, whilst the present disclosure is not limited to the above examples. A person skilled in the art may find
30 various alterations and modifications within the scope of the appended claims, and it should be understood that they will naturally come under the technical scope of the

present disclosure.

[0051]

Further, the effects described in this specification are merely illustrative or exemplified effects, and are not limitative. That is, with or in the place of the above
5 effects, the technology according to the present disclosure may achieve other effects that are clear to those skilled in the art from the description of this specification.

[0052]

Additionally, the present technology may also be configured as below.

(1)

10 An optical connector including:
optical transmission paths that have end faces aligned in a predetermined region, and transmit optical signals, in which
the optical transmission paths correspond to transmission channels or reception channels, and
15 the optical transmission paths of the transmission channels and the reception channels are arranged to have point symmetry about a center of the predetermined region.

(2)

The optical connector according to (1), in which
20 the optical transmission paths are arranged in N columns and M rows within the predetermined region.

(3)

The optical connector according to (2), in which
the optical transmission paths are arranged in N columns and M rows within
25 the predetermined region, and the optical transmission paths of the transmission channels are arranged in 0 to N/2 columns and 0 to M/2 rows, and (N/2 + 1) to N columns and (M/2 + 1) to M rows, N representing an even number, M representing an even number.

(4)

30 The optical connector according to (2), in which
the optical transmission paths are arranged in N columns and two rows within

the predetermined region, and the optical transmission paths of the transmission channels are arranged in 0 to $N/2$ columns in a first row, and $(N/2 + 1)$ to N columns in a second row, N representing an even number.

(5)

5 The optical connector according to (2), in which
 the optical transmission paths of the transmission channels and the reception
channels are alternately arranged.

(6)

 The optical connector according to (5), in which
10 N represents an even number, and the optical transmission paths of the
transmission channels and the reception channels are alternately arranged in a row
direction and a column direction.

(7)

 The optical connector according to (5), in which
15 N represents an odd number, the optical transmission paths of the
transmission channels and the reception channels are alternately arranged in a row
direction, and the optical transmission paths arranged in a given column in a column
direction are any one of the transmission channels and the reception channels.

(8)

20 The optical connector according to (7), in which
 the optical transmission paths of the transmission channels and the reception
channels are alternately arranged in columns at both ends in the column direction.

(9)

 The optical connector according to (7), in which
25 the optical transmission paths of the transmission channels are arranged in
columns at both ends in the column direction.

(10)

 The optical connector according to (1), in which
 outermost films of the optical transmission paths that are adjacent to each
30 other are arranged in close contact with each other.

Reference Signs List

[0053]

102, 202connector unit

400 optical fiber (optical transmission path)

5

CLAIMS

Claim 1

An optical connector comprising:
optical transmission paths that have end faces aligned in a predetermined
5 region, and transmit optical signals, wherein
the optical transmission paths correspond to transmission channels or
reception channels, and
the optical transmission paths of the transmission channels and the reception
channels are arranged to have point symmetry about a center of the predetermined
10 region.

Claim 2

The optical connector according to claim 1, wherein
the optical transmission paths are arranged in N columns and M rows within
15 the predetermined region.

Claim 3

The optical connector according to claim 2, wherein
the optical transmission paths are arranged in N columns and M rows within
20 the predetermined region, and the optical transmission paths of the transmission
channels are arranged in 0 to N/2 columns and 0 to M/2 rows, and (N/2 + 1) to N
columns and (M/2 + 1) to M rows, N representing an even number, M representing an
even number.

25 Claim 4

The optical connector according to claim 2, wherein
the optical transmission paths are arranged in N columns and two rows within
the predetermined region, and the optical transmission paths of the transmission
channels are arranged in 0 to N/2 columns in a first row, and (N/2 + 1) to N columns
30 in a second row, N representing an even number.

Claim 5

The optical connector according to claim 2, wherein the optical transmission paths of the transmission channels and the reception channels are alternately arranged.

5

Claim 6

The optical connector according to claim 5, wherein N represents an even number, and the optical transmission paths of the transmission channels and the reception channels are alternately arranged in a row direction and a column direction.

10

Claim 7

The optical connector according to claim 5, wherein N represents an odd number, the optical transmission paths of the transmission channels and the reception channels are alternately arranged in a row direction, and the optical transmission paths arranged in a given column in a column direction are any one of the transmission channels and the reception channels.

15

Claim 8

The optical connector according to claim 7, wherein the optical transmission paths of the transmission channels are arranged in columns at both ends in the column direction.

20

Claim 9

The optical connector according to claim 7, wherein the optical transmission paths of the transmission channels and the reception channels are alternately arranged in columns at both ends in the column direction.

25

Claim 10

The optical connector according to claim 1, wherein outermost films of the optical transmission paths that are adjacent to each

30

other are arranged in close contact with each other.

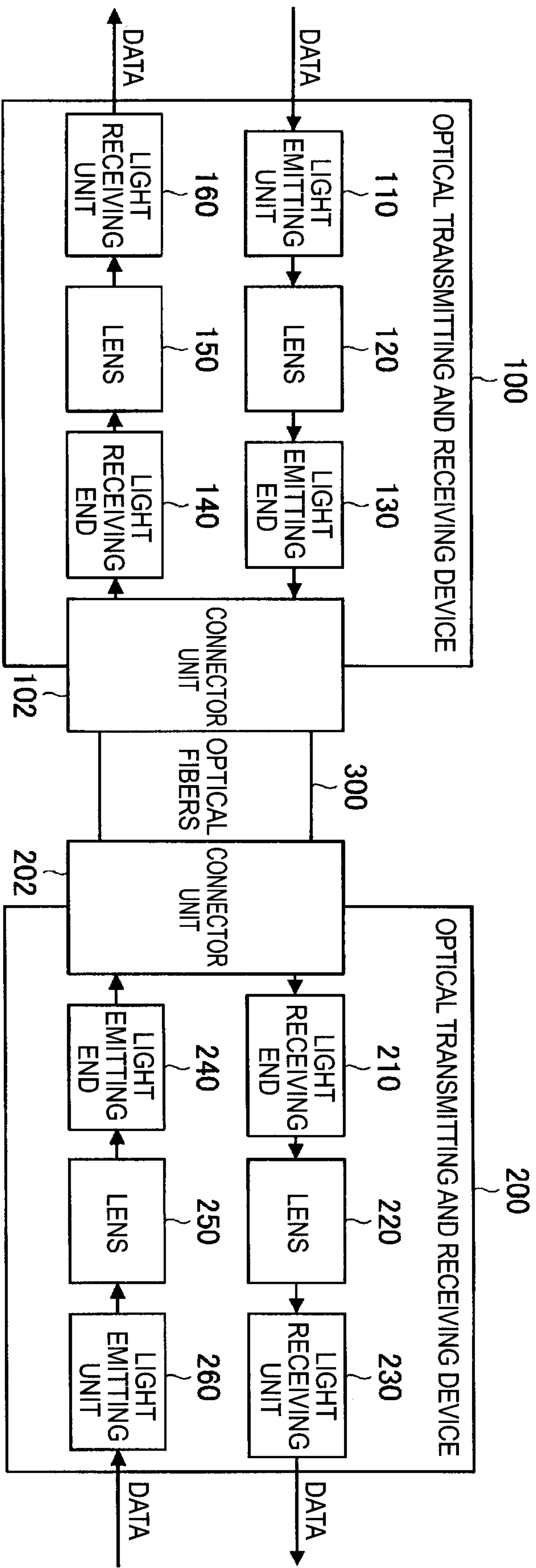

1/8
FIG. 1

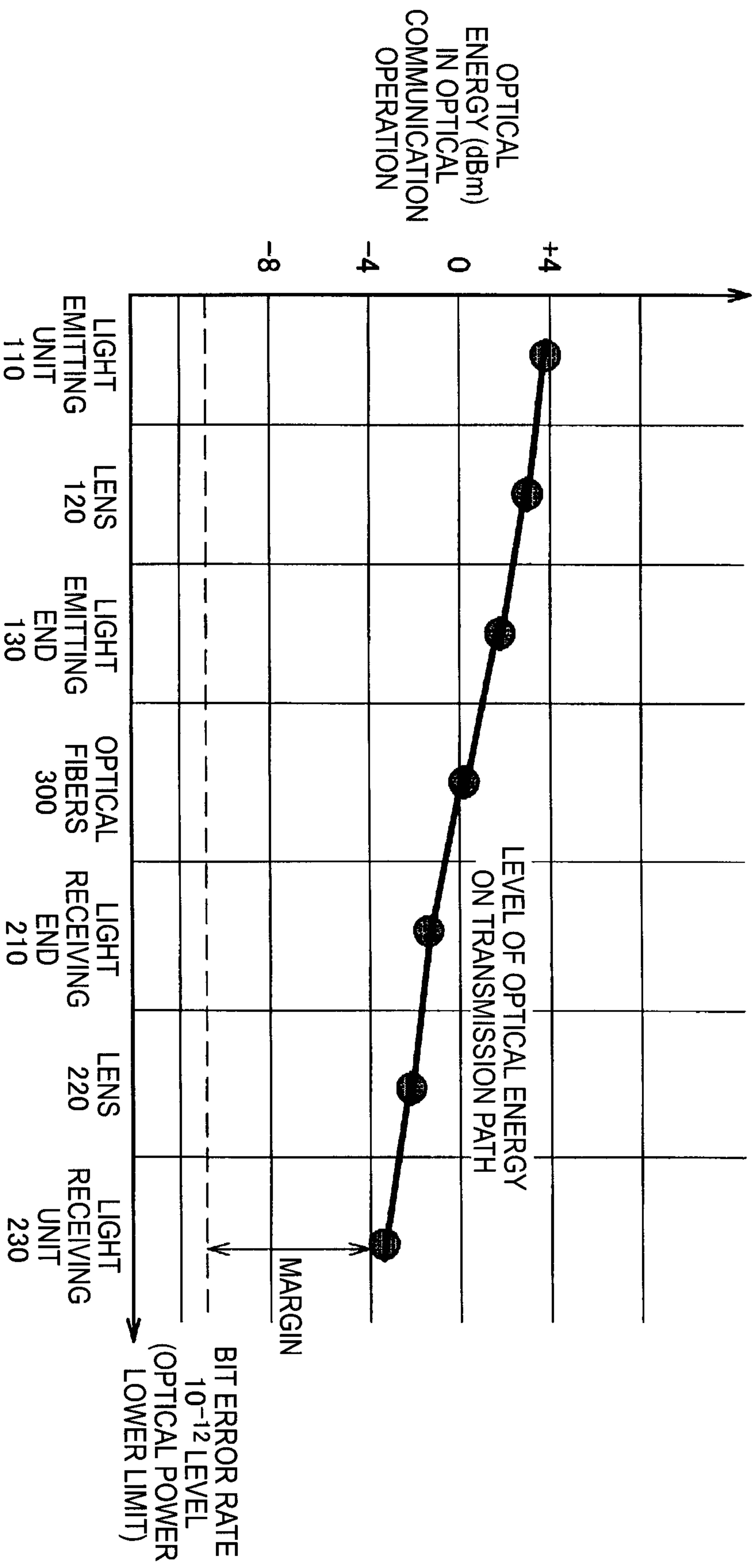

2/8
FIG. 2

OUTPUT P (dBm) OF
LIGHT EMITTED FROM
OPTICAL CONNECTOR

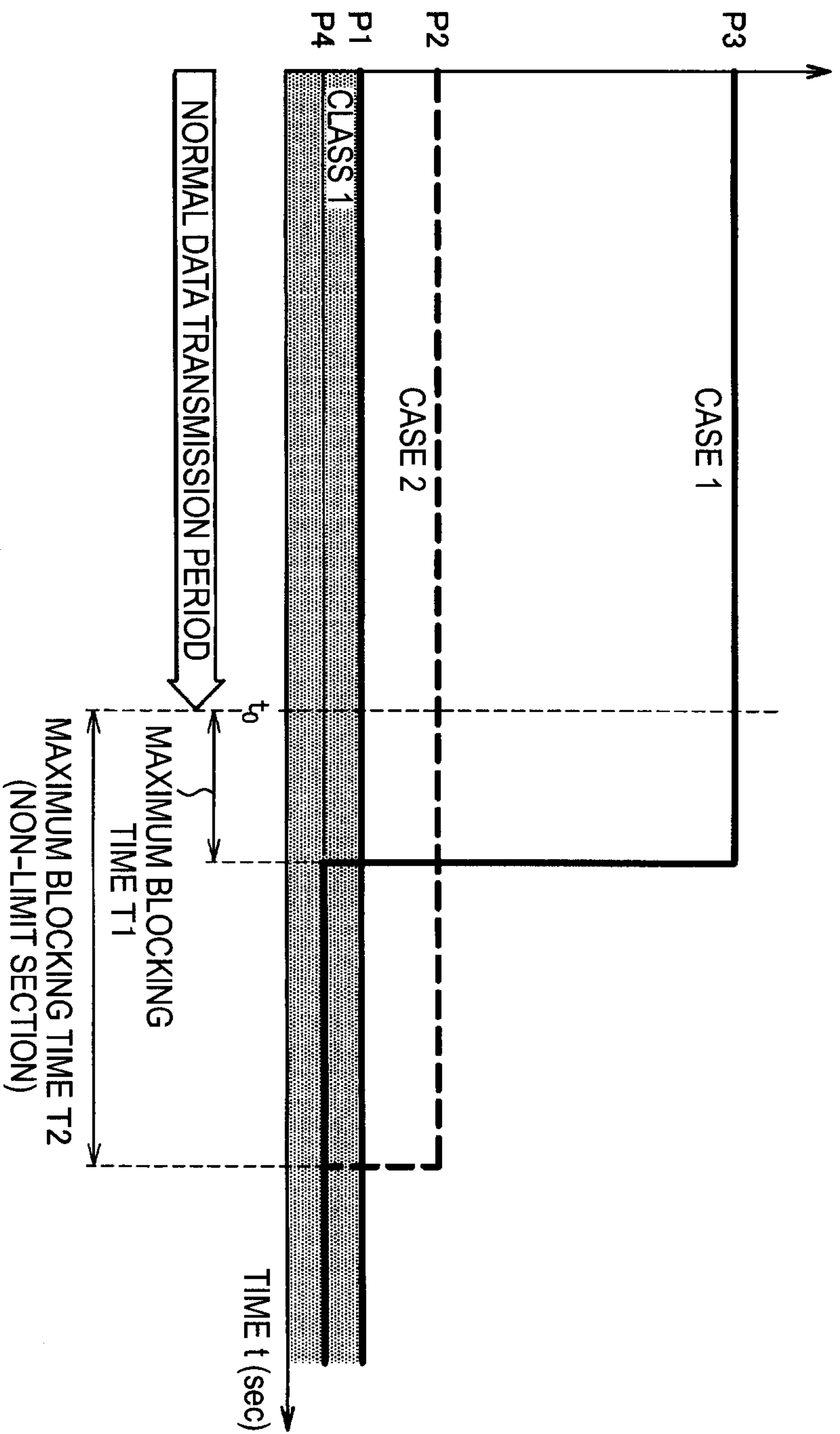

3/8
FIG. 3

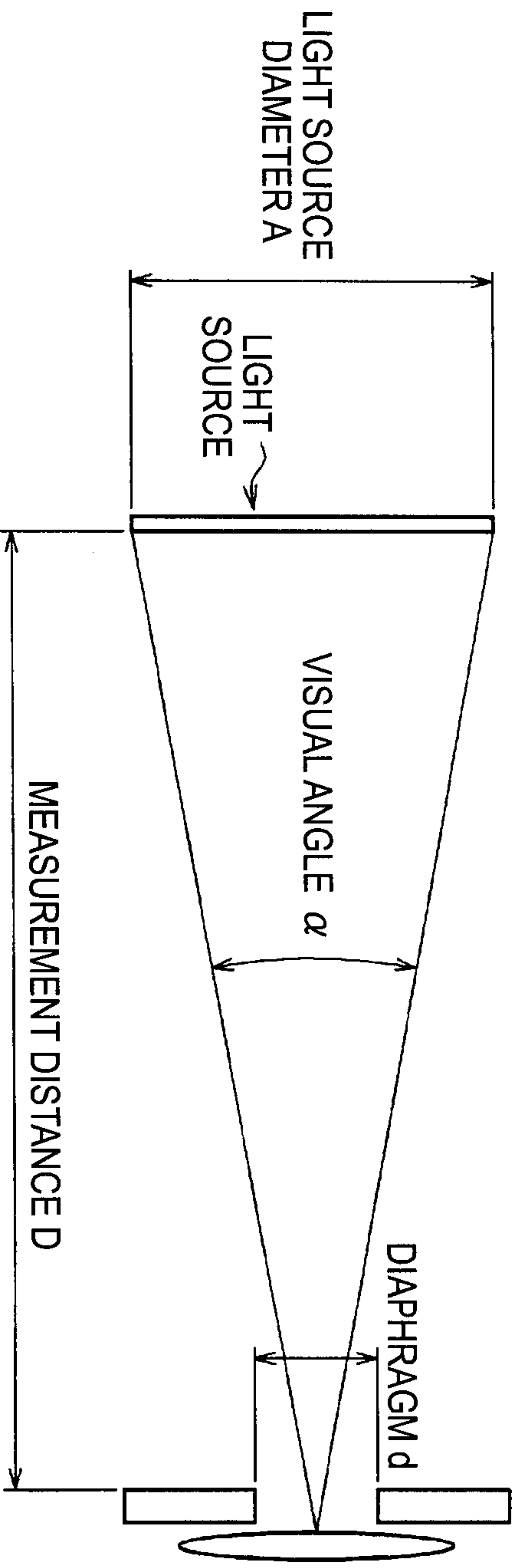

4/8
FIG. 4

5/8
FIG. 5

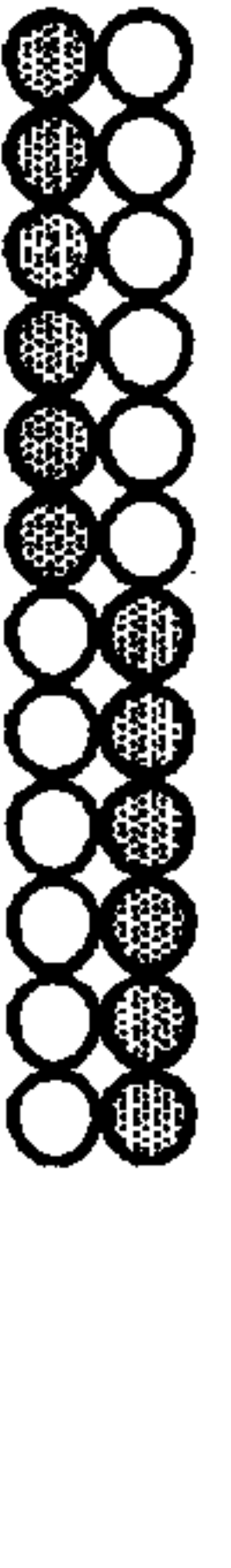
	TERMINAL ARRANGEMENT OF Tx/Rx AT OPTICAL CONNECTOR END O : Tx ● : Rx	Class 1 DEFAULT VALUE AEL (/ch)	MAXIMUM OUTPUT WHEN APR IS ACTIVATED (/ch)
(1) CASE WHERE Tx ARE CONCENTRATED		0.4 mW	2.5 mW
(2) CASE WHERE Tx ARE DISTRIBUTED IN HORIZONTAL DIRECTION		0.6 mW	3.7 mW

BLOCKING TIME: 0.01(sec)

FIG. 6

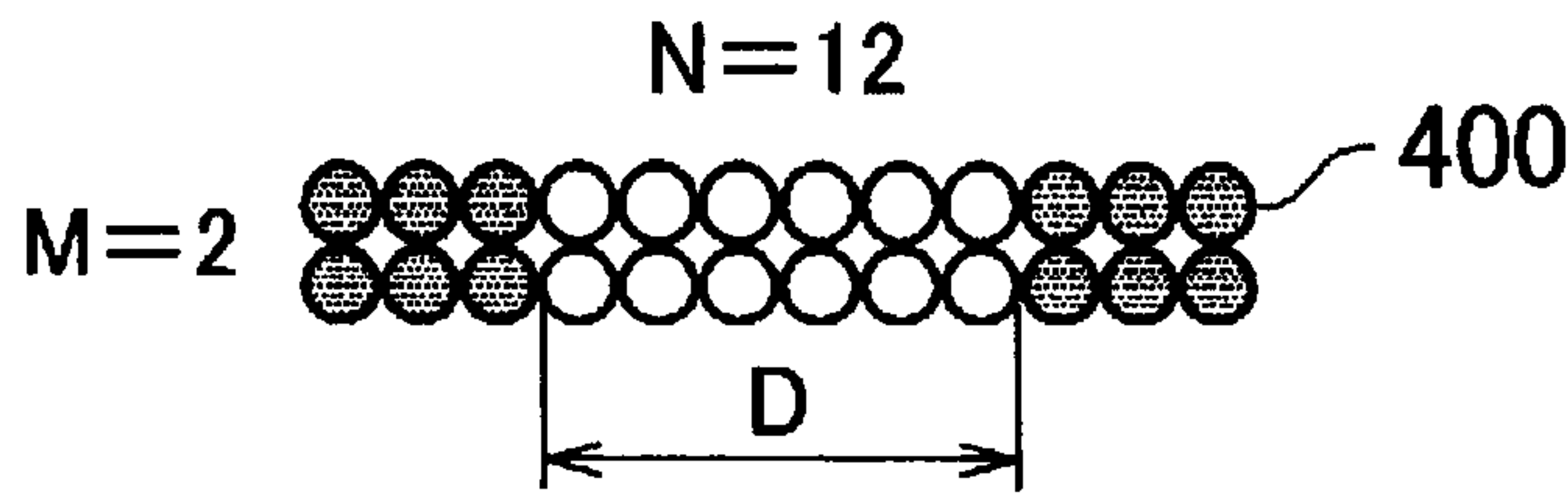

○: Tx
⊙: Rx

FIG. 7

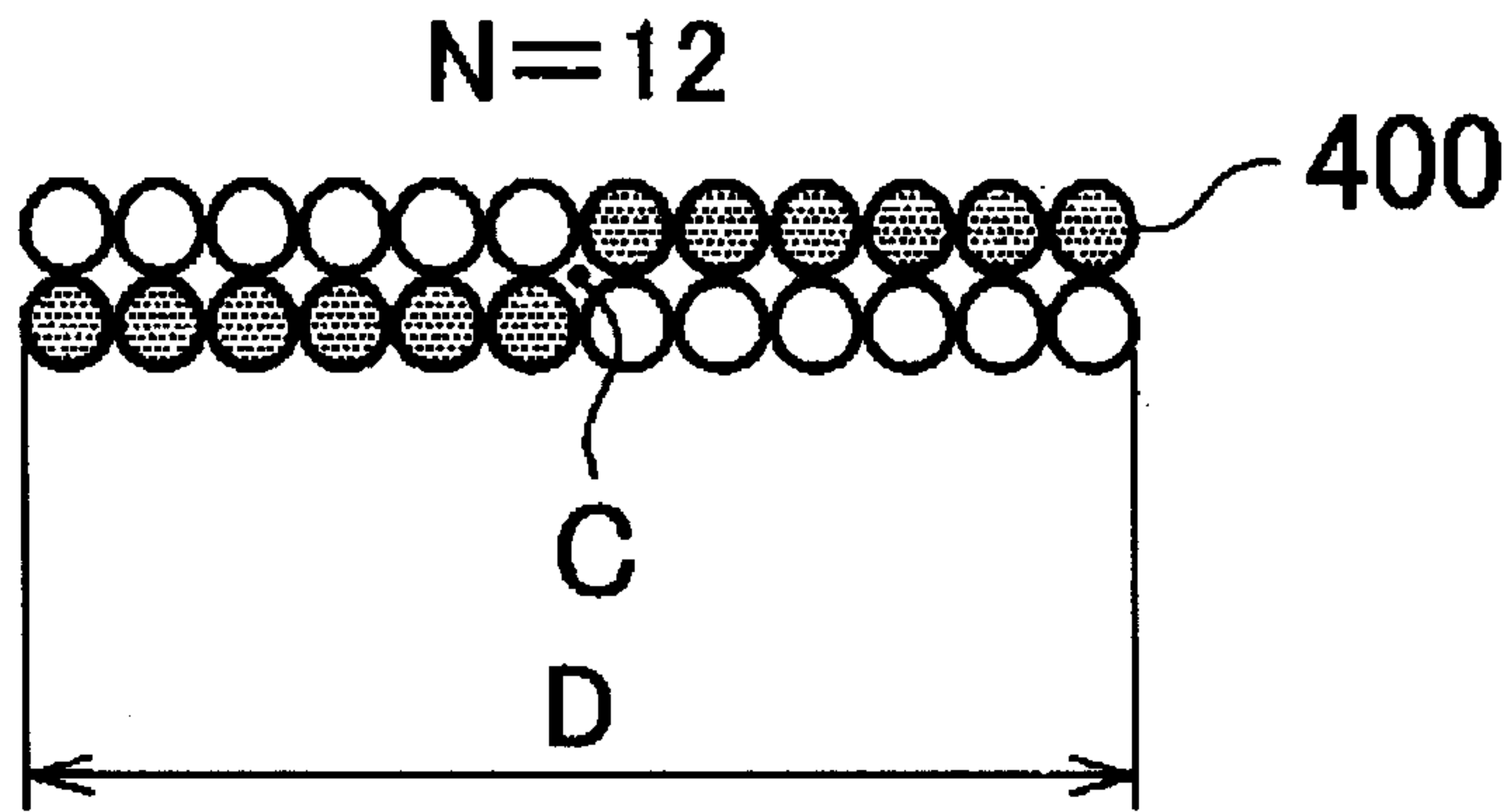

○: Tx
⊙: Rx

FIG. 8

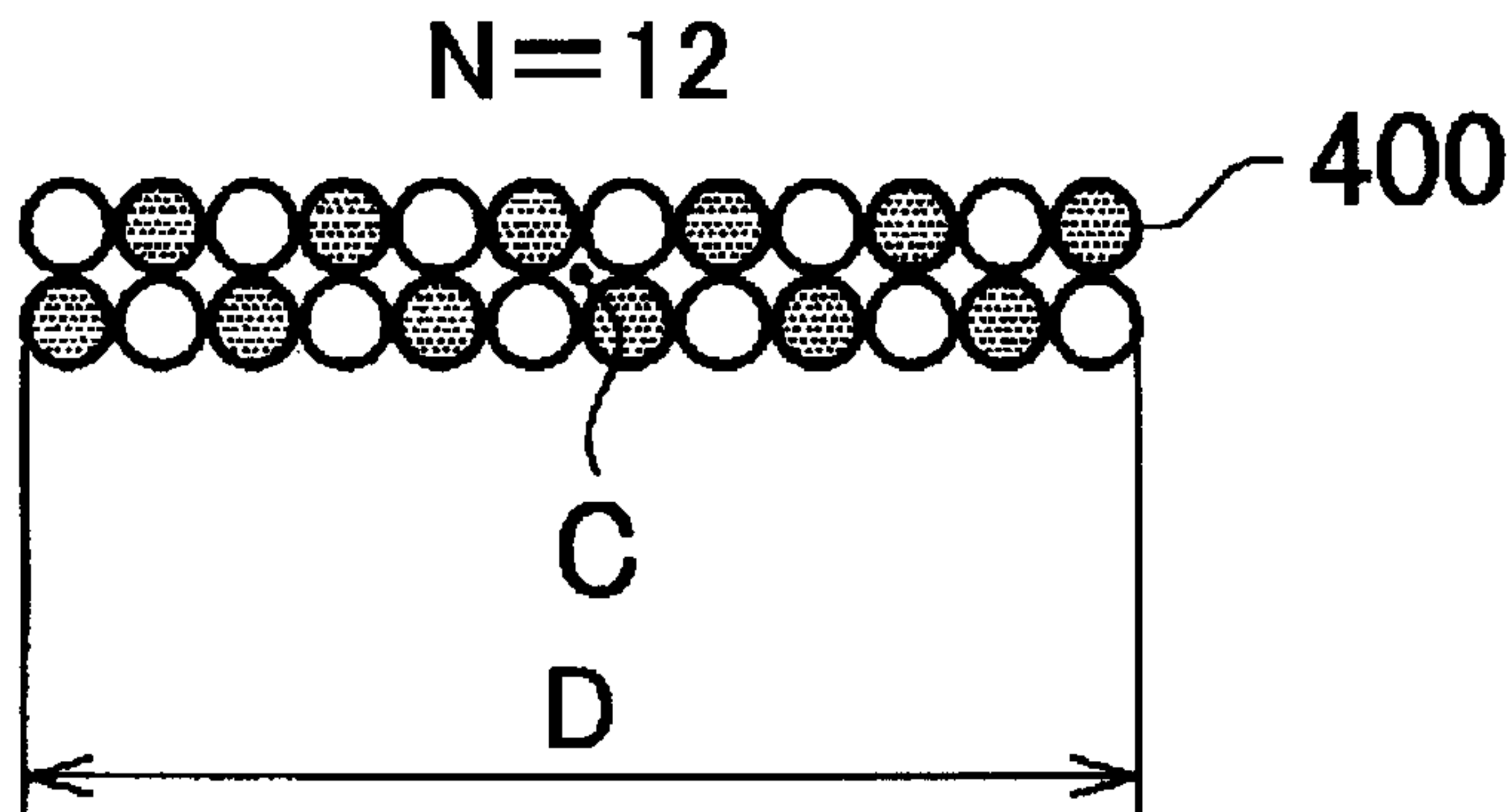

○: Tx
⊙: Rx

7/8

FIG. 9

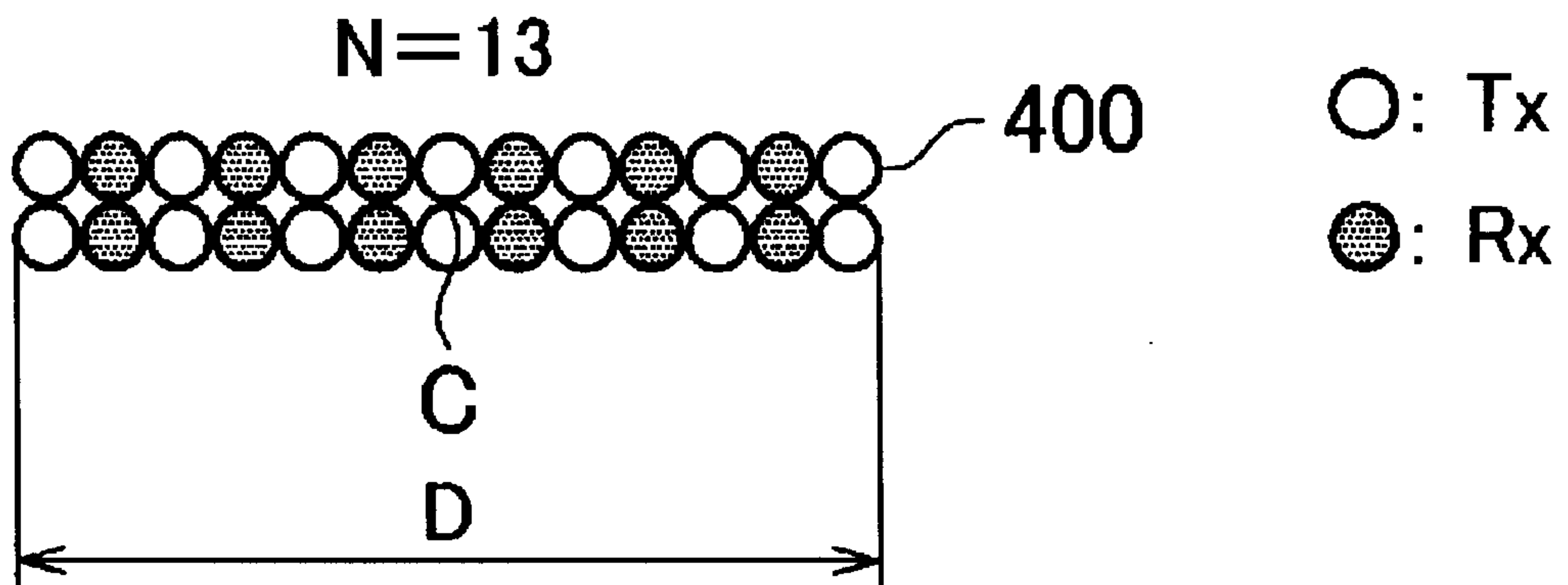
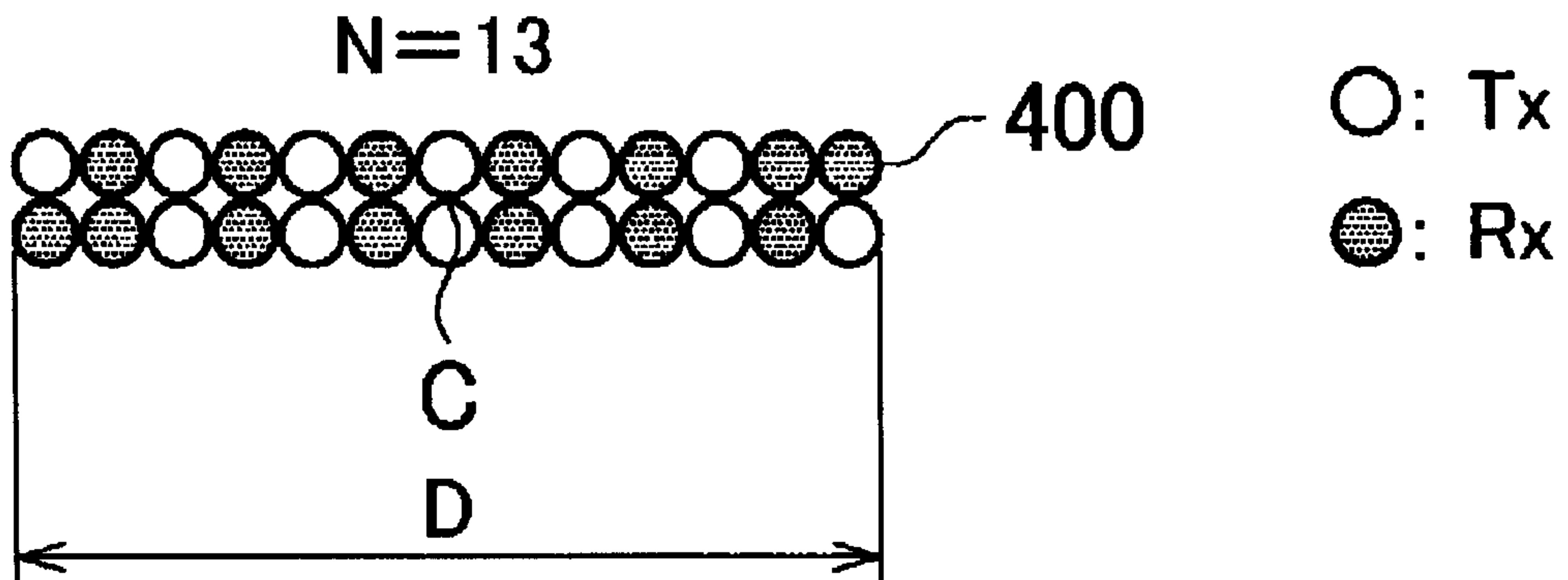

FIG. 10



O : Tx
● : Rx

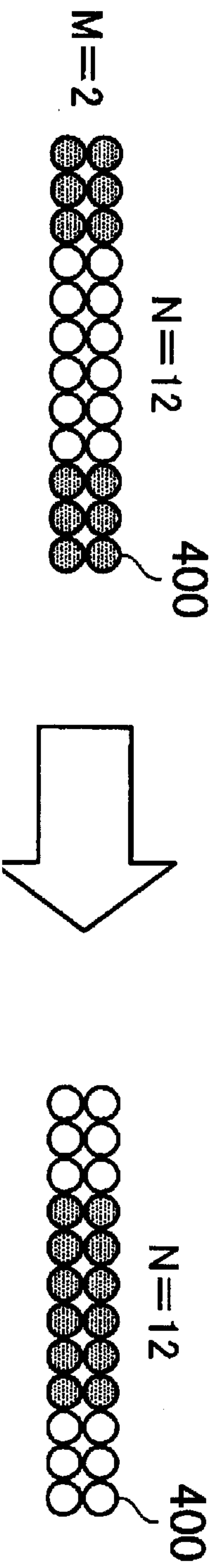

FIG. 11

