



US00D750030S

(12) **United States Design Patent**
Zerebilov et al.

(10) **Patent No.:** **US D750,030 S**
(45) **Date of Patent:** **** Feb. 23, 2016**

(54) **ELECTRICAL CABLE CONNECTOR**

(71) Applicants: **Arkady Y. Zerebilov**, Lancaster, PA (US); **Deborah A. Ingram**, Etters, PA (US); **Hung-Wei Lord**, Harrisburg, PA (US); **Jonathan E. Buck**, Milpitas, CA (US); **Stuart C. Stoner**, Lewisberry, PA (US); **Jason J. Ellison**, New Cumberland, PA (US)

(72) Inventors: **Arkady Y. Zerebilov**, Lancaster, PA (US); **Deborah A. Ingram**, Etters, PA (US); **Hung-Wei Lord**, Harrisburg, PA (US); **Jonathan E. Buck**, Milpitas, CA (US); **Stuart C. Stoner**, Lewisberry, PA (US); **Jason J. Ellison**, New Cumberland, PA (US)

(73) Assignee: **FCI AMERICAS TECHNOLOGY LLC**, Carson City, NV (US)

(**) Term: **14 Years**

(21) Appl. No.: **29/508,070**

(22) Filed: **Nov. 3, 2014**

Related U.S. Application Data

(63) Continuation of application No. 29/418,313, filed on Apr. 13, 2012, now Pat. No. Des. 718,253.

(51) **LOC (10) Cl.** **13-03**

(52) **U.S. Cl.**
USPC **D13/154**

(58) **Field of Classification Search**

USPC D13/147, 154, 184, 199; 439/74, 108, 439/180, 246, 252, 278, 374, 378, 379, 381, 439/527, 529, 533, 660, 717, 865-894, 439/953; 174/16.3; 257/697, 727; 361/769
See application file for complete search history.

(56) **References Cited**

U.S. PATENT DOCUMENTS

318,186 A 5/1885 Hertzog.
741,052 A 10/1903 Mahon

(Continued)

FOREIGN PATENT DOCUMENTS

DE 1665181 4/1974

(Continued)

OTHER PUBLICATIONS

U.S. Appl. No. 29/418,299, filed Apr. 12, 2012, Buck et al.
(Continued)

Primary Examiner — Daniel Bui

(74) *Attorney, Agent, or Firm* — Baker & Hostetler LLP

(57) **CLAIM**

The ornamental design for an electrical cable connector, as shown and described.

DESCRIPTION

FIG. 1 is a top, right, front perspective view of a first embodiment of an electrical cable connector showing our design; FIG. 2 is a bottom, left, front perspective view thereof; FIG. 3 is a top, left, rear perspective view thereof; FIG. 4 is a bottom, left, rear perspective view thereof; FIG. 5 is a front elevation view thereof; FIG. 6 is a rear elevation view thereof; FIG. 7 is a top plan view thereof; FIG. 8 is a bottom plan view thereof; FIG. 9 is a left side elevation view thereof; and FIG. 10 is a right side elevation view thereof. FIG. 11 is a top, left, front perspective view of a second embodiment of an electrical cable connector showing our new design; FIG. 12 is a top, right, rear perspective view thereof; FIG. 13 is a top, left, rear perspective view thereof; FIG. 14 is a bottom, right, rear perspective view thereof; FIG. 15 is a front elevation view thereof; FIG. 16 is a rear elevation view thereof; FIG. 17 is a top plan view thereof; FIG. 18 is a bottom plan view thereof; FIG. 19 is a left side elevation view thereof; and FIG. 20 is a right side elevation view thereof. In the drawing, the even-broken line represents unclaimed environment only and forms no part of the claimed design. The dash-dot line represents the boundary of the claimed design.

In a preferred embodiment, the nature of this product is an electrical component that can take the form of an electrical cable connector, a leadframe assembly therefor, an electrical shield therefor, such as an electrical ground shield, a leadframe housing and electrical contacts therefor, and a connector housing therefor.

1 Claim, 8 Drawing Sheets

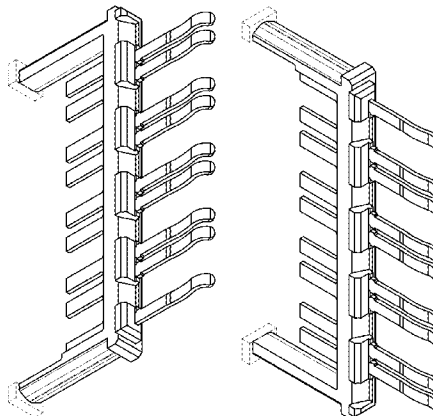

(56)

References Cited

U.S. PATENT DOCUMENTS

| | | | | | |
|-------------|---------|--------------------|-------------|---------|----------------------|
| 1,477,527 A | 12/1923 | Raettig | 4,505,529 A | 3/1985 | Barkus |
| D86,515 S | 3/1932 | Cox | 4,523,296 A | 6/1985 | Healy, Jr. |
| 2,231,347 A | 2/1941 | Reutter | 4,533,187 A | 8/1985 | Kirkman |
| 2,248,675 A | 7/1941 | Huppert | 4,536,955 A | 8/1985 | Gudgeon |
| 2,430,011 A | 11/1947 | Gillentine | 4,545,610 A | 10/1985 | Lakritz et al. |
| 2,664,552 A | 12/1953 | Ericsson et al. | 4,552,425 A | 11/1985 | Billman |
| 2,759,163 A | 8/1956 | Ustin et al. | 4,560,222 A | 12/1985 | Dambach |
| 2,762,022 A | 9/1956 | Benander et al. | 4,564,259 A | 1/1986 | Vandame |
| 2,849,700 A | 4/1958 | Perkin | 4,592,846 A | 6/1986 | Metzger et al. |
| 2,844,644 A | 7/1958 | Soule, Jr. | 4,596,428 A | 6/1986 | Tengler |
| 2,858,372 A | 10/1958 | Kaufman | 4,596,433 A | 6/1986 | Oesterheld et al. |
| 3,011,143 A | 11/1961 | Dean | 4,624,604 A | 11/1986 | Wagner et al. |
| 3,115,379 A | 12/1963 | McKee | 4,632,476 A | 12/1986 | Schell |
| 3,178,669 A | 4/1965 | Roberts | 4,641,426 A | 2/1987 | Hartman et al. |
| 3,179,738 A | 4/1965 | De Lyon | 4,655,515 A | 4/1987 | Hamsher, Jr. et al. |
| 3,208,030 A | 9/1965 | Evans et al. | 4,664,309 A | 5/1987 | Allen et al. |
| 3,286,220 A | 11/1966 | Marley et al. | 4,664,456 A | 5/1987 | Blair et al. |
| 3,320,658 A | 5/1967 | Bolda et al. | 4,664,458 A | 5/1987 | Worth |
| 3,337,838 A | 8/1967 | Damiano et al. | 4,678,250 A | 7/1987 | Romine et al. |
| 3,343,120 A | 9/1967 | Whiting | 4,685,886 A | 8/1987 | Denlinger et al. |
| 3,366,729 A | 1/1968 | Pauza | 4,705,205 A | 11/1987 | Allen et al. |
| 3,411,127 A | 11/1968 | Adams | 4,705,332 A | 11/1987 | Sadigh-Behzadi |
| 3,420,087 A | 1/1969 | Hatfield, et al. | 4,717,360 A | 1/1988 | Czaja |
| D213,697 S | 4/1969 | Oxley | 4,722,470 A | 2/1988 | Johary |
| 3,482,201 A | 12/1969 | Schneck | 4,734,060 A | 3/1988 | Kawawada et al. |
| 3,514,740 A | 5/1970 | Filson et al. | 4,762,500 A | 8/1988 | Dola et al. |
| 3,538,486 A | 11/1970 | Shlesinger, Jr. | 4,767,344 A | 8/1988 | Noschese |
| 3,560,908 A | 2/1971 | Dell et al. | 4,776,803 A | 10/1988 | Pretchel et al. |
| 3,591,834 A | 7/1971 | Kolias | 4,782,893 A | 11/1988 | Thomas |
| 3,634,811 A | 1/1972 | Teagno | 4,790,763 A | 12/1988 | Weber et al. |
| 3,641,475 A | 2/1972 | Irish et al. | 4,806,107 A | 2/1989 | Arnold et al. |
| 3,663,925 A | 5/1972 | Proctor | 4,815,987 A | 3/1989 | Kawano et al. |
| 3,669,054 A | 6/1972 | Desso et al. | 4,818,237 A | 4/1989 | Weber |
| 3,692,994 A | 9/1972 | Hirschman et al. | 4,820,169 A | 4/1989 | Weber et al. |
| 3,701,076 A | 10/1972 | Irish | 4,820,182 A | 4/1989 | Harwath et al. |
| 3,719,981 A | 3/1973 | Steitz | 4,824,383 A | 4/1989 | Lemke |
| 3,732,697 A | 5/1973 | Dickson | 4,830,264 A | 5/1989 | Bitailou et al. |
| 3,748,633 A | 7/1973 | Lundergan | 4,836,791 A | 6/1989 | Grabbe et al. |
| 3,827,005 A | 7/1974 | Friend | 4,844,813 A | 7/1989 | Helfgott et al. |
| 3,845,451 A | 10/1974 | Neidecker | 4,846,727 A | 7/1989 | Glover et al. |
| 3,864,004 A | 2/1975 | Friend | 4,850,887 A | 7/1989 | Sugawara |
| 3,865,462 A | 2/1975 | Cobaugh et al. | 4,854,899 A | 8/1989 | Matthews |
| 3,867,008 A | 2/1975 | Gartland, Jr. | 4,867,713 A | 9/1989 | Ozu et al. |
| 3,871,015 A | 3/1975 | Lin et al. | 4,871,110 A | 10/1989 | Fukasawa et al. |
| 3,889,364 A | 6/1975 | Krueger | 4,878,611 A | 11/1989 | LoVasco et al. |
| 3,942,856 A | 3/1976 | Mindheim et al. | 4,881,905 A | 11/1989 | Demler et al. |
| 3,972,580 A | 8/1976 | Pemberton et al. | 4,882,554 A | 11/1989 | Akaba et al. |
| 4,030,792 A | 6/1977 | Fuerst | 4,884,335 A | 12/1989 | McCoy et al. |
| 4,056,302 A | 11/1977 | Braun et al. | 4,898,539 A | 2/1990 | Glover et al. |
| 4,070,088 A | 1/1978 | Vaden | 4,900,271 A | 2/1990 | Colleran et al. |
| 4,076,362 A | 2/1978 | Ichimura | 4,904,212 A | 2/1990 | Durbin et al. |
| 4,082,407 A | 4/1978 | Smorzaniuk et al. | 4,907,990 A | 3/1990 | Bertho et al. |
| 4,097,266 A | 6/1978 | Takahashi et al. | 4,908,129 A | 3/1990 | Finsterwalder et al. |
| 4,136,919 A | 1/1979 | Howard et al. | 4,913,664 A | 4/1990 | Dixon et al. |
| 4,140,361 A | 2/1979 | Sochor | 4,915,641 A | 4/1990 | Miskin et al. |
| 4,159,861 A | 7/1979 | Anhalt | 4,917,616 A | 4/1990 | Demler, Jr. et al. |
| 4,217,024 A | 8/1980 | Aldridge et al. | 4,952,172 A | 8/1990 | Barkus et al. |
| 4,232,924 A | 11/1980 | Kline et al. | 4,963,102 A | 10/1990 | Gettig et al. |
| 4,260,212 A | 4/1981 | Ritchie et al. | 4,965,699 A | 10/1990 | Jorden et al. |
| 4,274,700 A | 6/1981 | Keglewitsch et al. | 4,973,257 A | 11/1990 | Lhotak |
| 4,288,139 A | 9/1981 | Cobaugh et al. | 4,973,271 A | 11/1990 | Ishizuka et al. |
| 4,371,912 A | 2/1983 | Guzik | 4,974,119 A | 11/1990 | Martin |
| 4,380,518 A | 4/1983 | Wydro, Sr. | 4,975,069 A | 12/1990 | Fedder et al. |
| 4,383,724 A | 5/1983 | Verhoeven | 4,975,084 A | 12/1990 | Fedder et al. |
| 4,395,086 A | 7/1983 | Marsh | 4,979,074 A | 12/1990 | Morley et al. |
| 4,396,140 A | 8/1983 | Jaffe et al. | 4,997,390 A | 3/1991 | Scholz et al. |
| 4,402,563 A | 9/1983 | Sinclair | 5,004,426 A | 4/1991 | Barnett |
| 4,403,821 A | 9/1983 | Zimmerman et al. | 5,016,968 A | 5/1991 | Hammond et al. |
| 4,448,467 A | 5/1984 | Weidler | 5,024,372 A | 6/1991 | Altman et al. |
| 4,462,534 A | 7/1984 | Bitailou et al. | 5,024,610 A | 6/1991 | French et al. |
| 4,464,003 A | 8/1984 | Goodman et al. | 5,035,631 A | 7/1991 | Piorunneck et al. |
| 4,473,113 A | 9/1984 | Whitfield et al. | 5,035,639 A | 7/1991 | Kilpatrick et al. |
| 4,473,477 A | 9/1984 | Beall | 5,046,960 A | 9/1991 | Fedder et al. |
| D275,849 S | 10/1984 | Sakurai | 5,052,953 A | 10/1991 | Weber |
| 4,482,937 A | 11/1984 | Berg | 5,055,054 A | 10/1991 | Doutrich |
| | | | 5,060,844 A | 10/1991 | Behun et al. |
| | | | 5,065,282 A | 11/1991 | Polonio |
| | | | 5,066,236 A | 11/1991 | Broeksteeg |
| | | | 5,077,893 A | 1/1992 | Mosquera et al. |

(56)

References Cited

U.S. PATENT DOCUMENTS

| | | | | | |
|-------------|---------|-----------------------|-------------|---------|--------------------|
| 5,082,459 A | 1/1992 | Billman et al. | 5,410,807 A | 5/1995 | Bross et al. |
| 5,083,238 A | 1/1992 | Bousman | 5,427,543 A | 6/1995 | Dynia |
| 5,093,986 A | 3/1992 | Mandai et al. | 5,429,520 A | 7/1995 | Morlion et al. |
| 5,094,623 A | 3/1992 | Scharf et al. | 5,429,521 A | 7/1995 | Morlion et al. |
| 5,094,634 A | 3/1992 | Dixon et al. | 5,431,332 A | 7/1995 | Kirby et al. |
| 5,098,311 A | 3/1992 | Roath et al. | 5,431,578 A | 7/1995 | Wayne |
| 5,104,332 A | 4/1992 | McCoy | 5,433,617 A | 7/1995 | Morlion et al. |
| 5,104,341 A | 4/1992 | Gilissen et al. | 5,433,618 A | 7/1995 | Morlion et al. |
| 5,111,991 A | 5/1992 | Clawson et al. | 5,435,482 A | 7/1995 | Variot et al. |
| 5,117,331 A | 5/1992 | Gebara | 5,442,852 A | 8/1995 | Danner |
| 5,118,027 A | 6/1992 | Braun et al. | 5,445,313 A | 8/1995 | Boyd et al. |
| 5,120,237 A | 6/1992 | Fussell | 5,457,342 A | 10/1995 | Herbst, II |
| 5,127,839 A | 7/1992 | Korsunsky et al. | 5,458,426 A | 10/1995 | Ito |
| 5,131,871 A | 7/1992 | Banakis et al. | 5,462,456 A | 10/1995 | Howell |
| 5,137,959 A | 8/1992 | Block et al. | 5,467,913 A | 11/1995 | Namekawa et al. |
| 5,139,426 A | 8/1992 | Barkus et al. | 5,474,472 A | 12/1995 | Niwa et al. |
| 5,145,104 A | 9/1992 | Apap et al. | 5,475,922 A | 12/1995 | Tamura et al. |
| 5,151,056 A | 9/1992 | McClune | 5,477,933 A | 12/1995 | Nguyen |
| 5,152,700 A | 10/1992 | Bogursky et al. | 5,489,750 A | 2/1996 | Sakemi et al. |
| 5,161,987 A | 11/1992 | Sinisi | 5,490,040 A | 2/1996 | Gaudenzi et al. |
| 5,163,337 A | 11/1992 | Herron et al. | 5,491,303 A | 2/1996 | Weiss |
| 5,163,849 A | 11/1992 | Fogg et al. | 5,492,266 A | 2/1996 | Hoebener et al. |
| 5,167,528 A | 12/1992 | Nishiyama et al. | 5,495,668 A | 3/1996 | Furusawa et al. |
| 5,169,337 A | 12/1992 | Ortega et al. | 5,496,183 A | 3/1996 | Soes et al. |
| 5,174,770 A | 12/1992 | Sasaki et al. | 5,498,167 A | 3/1996 | Seto et al. |
| 5,181,855 A | 1/1993 | Mosquera et al. | 5,499,487 A | 3/1996 | McGill |
| 5,194,480 A | 3/1993 | Block et al. | 5,504,277 A | 4/1996 | Danner |
| 5,199,885 A | 4/1993 | Korsunsky et al. | 5,511,987 A | 4/1996 | Shinchi |
| 5,203,075 A | 4/1993 | Angulas et al. | 5,512,519 A | 4/1996 | Hwang |
| 5,207,372 A | 5/1993 | Funari et al. | 5,516,030 A | 5/1996 | Denton |
| 5,213,868 A | 5/1993 | Liberty et al. | 5,516,032 A | 5/1996 | Sakemi et al. |
| 5,214,308 A | 5/1993 | Nishiguchi | 5,518,410 A | 5/1996 | Masami |
| 5,217,381 A | 6/1993 | Zell et al. | 5,519,580 A | 5/1996 | Natarajan et al. |
| 5,222,649 A | 6/1993 | Funari et al. | 5,522,727 A | 6/1996 | Saito et al. |
| 5,224,867 A | 7/1993 | Ohtsuki et al. | 5,533,915 A | 7/1996 | Deans |
| 5,228,864 A | 7/1993 | Fusselman et al. | 5,534,127 A | 7/1996 | Sakai |
| 5,229,016 A | 7/1993 | Hayes et al. | 5,539,153 A | 7/1996 | Schwiebert et al. |
| 5,238,414 A | 8/1993 | Yaegashi et al. | 5,542,174 A | 8/1996 | Chiu |
| 5,254,012 A | 10/1993 | Wang | 5,558,542 A | 9/1996 | O'Sullivan et al. |
| 5,255,839 A | 10/1993 | Da Costa Alves et al. | 5,564,952 A | 10/1996 | Davis |
| 5,257,941 A | 11/1993 | Lwee et al. | 5,575,688 A | 11/1996 | Crane, Jr. |
| 5,261,155 A | 11/1993 | Angulas et al. | 5,577,928 A | 11/1996 | Duclos |
| 5,269,453 A | 12/1993 | Melton et al. | 5,580,283 A | 12/1996 | O'Sullivan et al. |
| 5,274,918 A | 1/1994 | Reed | 5,586,908 A | 12/1996 | Lorrain |
| 5,275,330 A | 1/1994 | Isaacs et al. | 5,586,914 A | 12/1996 | Foster, Jr. et al. |
| 5,276,964 A | 1/1994 | Anderson, Jr. et al. | 5,588,859 A | 12/1996 | Maurice |
| 5,277,624 A | 1/1994 | Champion et al. | 5,590,463 A | 1/1997 | Feldman et al. |
| 5,284,287 A | 2/1994 | Wilson et al. | 5,591,118 A | 1/1997 | Bierck |
| 5,285,163 A | 2/1994 | Liotta | 5,591,941 A | 1/1997 | Acocella et al. |
| 5,286,212 A | 2/1994 | Broeksteeg | 5,593,322 A | 1/1997 | Swamy et al. |
| 5,288,949 A | 2/1994 | Crafts | 5,605,417 A | 2/1997 | Englert et al. |
| 5,295,843 A | 3/1994 | Davis et al. | 5,609,502 A | 3/1997 | Thumma |
| 5,298,791 A | 3/1994 | Liberty et al. | 5,613,882 A | 3/1997 | Hnatuck et al. |
| 5,302,135 A | 4/1994 | Lee | 5,618,187 A | 4/1997 | Goto |
| 5,321,582 A | 6/1994 | Casperson | 5,634,821 A | 6/1997 | Crane, Jr. |
| 5,324,569 A | 6/1994 | Nagesh et al. | 5,637,008 A | 6/1997 | Kozel |
| 5,342,211 A | 8/1994 | Broeksteeg | 5,637,019 A | 6/1997 | Crane, Jr. et al. |
| 5,344,327 A | 9/1994 | Brunker et al. | 5,643,009 A | 7/1997 | Dinkel et al. |
| 5,346,118 A | 9/1994 | Degani et al. | 5,664,968 A | 9/1997 | Micklevicz |
| 5,354,219 A | 10/1994 | Wanjura | 5,664,973 A | 9/1997 | Emmert et al. |
| 5,355,283 A | 10/1994 | Marrs et al. | 5,667,392 A | 9/1997 | Kocher et al. |
| 5,356,300 A | 10/1994 | Costello et al. | 5,672,064 A | 9/1997 | Provencher et al. |
| 5,356,301 A | 10/1994 | Champion et al. | 5,691,041 A | 11/1997 | Frankeny et al. |
| 5,357,050 A | 10/1994 | Baran et al. | D387,733 S | 12/1997 | Lee |
| 5,358,417 A | 10/1994 | Schmedding | 5,697,799 A | 12/1997 | Consoli et al. |
| 5,377,902 A | 1/1995 | Hayes | 5,702,255 A | 12/1997 | Murphy et al. |
| 5,381,314 A | 1/1995 | Rudy, Jr. et al. | 5,713,746 A | 2/1998 | Olson et al. |
| 5,382,168 A | 1/1995 | Azuma et al. | 5,718,606 A | 2/1998 | Rigby et al. |
| D355,409 S | 2/1995 | Krokaugger | 5,727,963 A | 3/1998 | LeMaster |
| 5,387,111 A | 2/1995 | DeSantis et al. | 5,730,609 A | 3/1998 | Harwath |
| 5,387,139 A | 2/1995 | McKee et al. | 5,733,453 A | 3/1998 | DeBusk |
| 5,395,250 A | 3/1995 | Englert, Jr. et al. | 5,741,144 A | 4/1998 | Elco et al. |
| 5,400,949 A | 3/1995 | Hirvonen et al. | 5,741,161 A | 4/1998 | Cahaly et al. |
| 5,403,206 A | 4/1995 | McNamara et al. | 5,742,484 A | 4/1998 | Gillette et al. |
| 5,409,157 A | 4/1995 | Nagesh et al. | 5,743,009 A | 4/1998 | Matsui et al. |
| | | | 5,743,765 A | 4/1998 | Andrews et al. |
| | | | 5,745,349 A | 4/1998 | Lemke |
| | | | 5,746,608 A | 5/1998 | Taylor |
| | | | 5,749,746 A | 5/1998 | Tan et al. |

(56)

References Cited

U.S. PATENT DOCUMENTS

| | | | | | |
|-------------|---------|---------------------|--------------|---------|----------------------|
| 5,755,595 A | 5/1998 | Davis et al. | 6,125,535 A | 10/2000 | Chiou et al. |
| 5,766,023 A | 6/1998 | Noschese et al. | 6,129,592 A | 10/2000 | Mickievicz et al. |
| 5,772,451 A | 6/1998 | Dozier, II et al. | 6,132,255 A | 10/2000 | Verhoeven |
| 5,782,644 A | 7/1998 | Kiat | 6,139,336 A | 10/2000 | Olson |
| 5,787,971 A | 8/1998 | Dodson | 6,146,157 A | 11/2000 | Lenoir et al. |
| 5,795,191 A | 8/1998 | Preputnick et al. | 6,146,202 A | 11/2000 | Ramey et al. |
| 5,810,607 A | 9/1998 | Shih et al. | 6,146,203 A | 11/2000 | Elco et al. |
| 5,817,973 A | 10/1998 | Elco et al. | 6,152,747 A | 11/2000 | McNamara |
| 5,827,094 A | 10/1998 | Aizawa et al. | 6,152,756 A | 11/2000 | Huang et al. |
| 5,831,314 A | 11/1998 | Wen | 6,154,742 A | 11/2000 | Herriot |
| 5,833,475 A | 11/1998 | Mitra | 6,171,115 B1 | 1/2001 | Mickievicz et al. |
| 5,846,024 A | 12/1998 | Mao et al. | 6,171,149 B1 | 1/2001 | Van Zanten |
| 5,851,121 A | 12/1998 | Thenaisie et al. | 6,174,198 B1 | 1/2001 | Wu et al. |
| 5,853,797 A | 12/1998 | Fuchs et al. | 6,179,663 B1 | 1/2001 | Bradley et al. |
| 5,857,857 A | 1/1999 | Fukuda | 6,180,891 B1 | 1/2001 | Murdeshwar |
| 5,860,814 A | 1/1999 | Akama et al. | 6,183,287 B1 | 2/2001 | Po |
| 5,860,816 A | 1/1999 | Provencher et al. | 6,183,301 B1 | 2/2001 | Paagman |
| 5,871,362 A | 2/1999 | Campbell et al. | 6,190,213 B1 | 2/2001 | Reichart et al. |
| 5,874,776 A | 2/1999 | Kresge et al. | 6,193,537 B1 | 2/2001 | Harper, Jr. et al. |
| 5,876,219 A | 3/1999 | Taylor | 6,196,871 B1 | 3/2001 | Szu |
| 5,876,222 A | 3/1999 | Gardner et al. | 6,202,916 B1 | 3/2001 | Updike et al. |
| 5,876,248 A | 3/1999 | Brunker et al. | 6,206,722 B1 | 3/2001 | Ko et al. |
| 5,882,214 A | 3/1999 | Hillbush et al. | 6,206,735 B1 | 3/2001 | Zanolli |
| 5,883,782 A | 3/1999 | Thurston et al. | 6,210,197 B1 | 4/2001 | Yu |
| 5,887,158 A | 3/1999 | Sample et al. | 6,210,240 B1 | 4/2001 | Comerci et al. |
| 5,888,884 A | 3/1999 | Wojnarowski | 6,212,755 B1 | 4/2001 | Shimada et al. |
| 5,892,791 A | 4/1999 | Moon | 6,215,180 B1 | 4/2001 | Chen et al. |
| 5,893,761 A | 4/1999 | Longueville | 6,219,913 B1 | 4/2001 | Uchiyama |
| 5,902,136 A | 5/1999 | Lemke et al. | 6,220,884 B1 | 4/2001 | Lin |
| 5,904,581 A | 5/1999 | Pope et al. | 6,220,895 B1 | 4/2001 | Lin |
| 5,908,333 A | 6/1999 | Perino et al. | 6,220,896 B1 | 4/2001 | Bertoncini et al. |
| 5,913,702 A | 6/1999 | Garcin | 6,227,882 B1 | 5/2001 | Ortega et al. |
| 5,919,050 A | 7/1999 | Kehley et al. | 6,231,391 B1 | 5/2001 | Ramey et al. |
| 5,930,114 A | 7/1999 | Kuzmin et al. | 6,234,851 B1 | 5/2001 | Phillips |
| 5,938,479 A | 8/1999 | Paulson et al. | 6,238,225 B1 | 5/2001 | Middlehurst et al. |
| 5,943,770 A | 8/1999 | Thenaisie et al. | 6,241,535 B1 | 6/2001 | Lemke et al. |
| 5,955,888 A | 9/1999 | Frederickson et al. | 6,244,887 B1 | 6/2001 | Commerci et al. |
| 5,961,355 A | 10/1999 | Morlion et al. | 6,257,478 B1 | 7/2001 | Straub |
| 5,967,844 A | 10/1999 | Doutrich et al. | 6,259,039 B1 | 7/2001 | Chroneos, Jr. et al. |
| 5,971,817 A | 10/1999 | Longueville | 6,261,132 B1 | 7/2001 | Koseki et al. |
| 5,975,921 A | 11/1999 | Shuey | 6,267,604 B1 | 7/2001 | Mickievicz et al. |
| 5,980,270 A | 11/1999 | Fjelstad et al. | 6,269,539 B1 | 8/2001 | Takahashi et al. |
| 5,980,321 A | 11/1999 | Cohen et al. | 6,274,474 B1 | 8/2001 | Caletka et al. |
| 5,982,249 A | 11/1999 | Bruns | 6,280,209 B1 | 8/2001 | Bassler et al. |
| 5,984,690 A | 11/1999 | Riechelmann et al. | 6,280,230 B1 | 8/2001 | Takase et al. |
| 5,984,726 A | 11/1999 | Wu | 6,280,809 B1 | 8/2001 | Wang |
| 5,992,953 A | 11/1999 | Rabinovitz | 6,290,552 B1 | 9/2001 | Saito et al. |
| 5,993,259 A | 11/1999 | Stokoe et al. | 6,293,827 B1 | 9/2001 | Stokoe et al. |
| 6,012,948 A | 1/2000 | Wu | 6,299,483 B1 | 10/2001 | Cohen et al. |
| 6,022,227 A | 2/2000 | Huang | 6,299,484 B2 | 10/2001 | Van Woensel et al. |
| 6,024,584 A | 2/2000 | Lemke et al. | 6,299,492 B1 | 10/2001 | Pierini et al. |
| 6,027,381 A | 2/2000 | Lok | 6,302,711 B1 | 10/2001 | Ito |
| 6,036,549 A | 3/2000 | Wulff | 6,309,245 B1 | 10/2001 | Sweeney |
| 6,041,498 A | 3/2000 | Hillbush et al. | 6,319,075 B1 | 11/2001 | Clark et al. |
| 6,042,389 A | 3/2000 | Lemke et al. | 6,322,377 B2 | 11/2001 | Middlehurst et al. |
| 6,042,394 A | 3/2000 | Mitra et al. | 6,322,379 B1 | 11/2001 | Ortega et al. |
| 6,042,427 A | 3/2000 | Adriaenssens et al. | 6,322,393 B1 | 11/2001 | Doutrich et al. |
| 6,048,213 A | 4/2000 | Lai et al. | 6,328,602 B1 | 12/2001 | Yamasaki et al. |
| 6,050,842 A | 4/2000 | Ferrill et al. | 6,338,635 B1 | 1/2002 | Lee |
| 6,050,862 A | 4/2000 | Ishii | 6,343,955 B2 | 2/2002 | Billman et al. |
| 6,053,751 A | 4/2000 | Humphrey | 6,347,952 B1 | 2/2002 | Hasegawa et al. |
| 6,059,170 A | 5/2000 | Jimarez et al. | 6,347,962 B1 | 2/2002 | Kline |
| 6,066,048 A | 5/2000 | Lees | 6,350,134 B1 | 2/2002 | Fogg et al. |
| 6,068,518 A | 5/2000 | McEuen | 6,354,877 B1 | 3/2002 | Shuey et al. |
| 6,068,520 A | 5/2000 | Winings et al. | 6,358,061 B1 | 3/2002 | Regnier |
| 6,071,152 A | 6/2000 | Achammer et al. | 6,359,783 B1 | 3/2002 | Noble |
| 6,077,130 A | 6/2000 | Hughes et al. | 6,360,940 B1 | 3/2002 | Bolde et al. |
| 6,083,047 A | 7/2000 | Paagman | 6,361,366 B1 | 3/2002 | Shuey et al. |
| 6,086,386 A | 7/2000 | Fjelstad et al. | 6,361,376 B1 | 3/2002 | Onoda |
| 6,089,878 A | 7/2000 | Meng | 6,362,961 B1 | 3/2002 | Chiou |
| 6,095,827 A | 8/2000 | Dutkowsky et al. | 6,363,607 B1 | 4/2002 | Chen et al. |
| 6,113,418 A | 9/2000 | Kjeldahl | 6,364,710 B1 | 4/2002 | Billman et al. |
| 6,116,926 A | 9/2000 | Ortega et al. | 6,371,773 B1 | 4/2002 | Crofoot et al. |
| 6,116,965 A | 9/2000 | Arnett et al. | 6,371,813 B2 | 4/2002 | Ramey et al. |
| 6,123,554 A | 9/2000 | Ortega et al. | 6,375,478 B1 | 4/2002 | Kikuchi |
| | | | 6,375,508 B1 | 4/2002 | Pickles et al. |
| | | | 6,379,188 B1 | 4/2002 | Cohen et al. |
| | | | 6,386,914 B1 | 5/2002 | Collins et al. |
| | | | 6,386,924 B2 | 5/2002 | Long |

(56)

References Cited

U.S. PATENT DOCUMENTS

| | | | | | | | |
|-----------|----|---------|---------------------|-----------|----|---------|----------------------|
| 6,390,826 | B1 | 5/2002 | Affolter et al. | 6,702,594 | B2 | 3/2004 | Lee et al. |
| 6,394,818 | B1 | 5/2002 | Smalley, Jr. | 6,705,902 | B1 | 3/2004 | Yi et al. |
| 6,402,566 | B1 | 6/2002 | Middlehurst et al. | 6,709,294 | B1 | 3/2004 | Cohen et al. |
| 6,409,543 | B1 | 6/2002 | Astbury, Jr. et al. | 6,712,621 | B2 | 3/2004 | Li et al. |
| 6,414,248 | B1 | 7/2002 | Sundstrom | 6,712,646 | B2 | 3/2004 | Shindo |
| 6,420,778 | B1 | 7/2002 | Sinyansky | 6,716,045 | B2 | 4/2004 | Meredith |
| 6,425,785 | B1 | 7/2002 | Azuma | 6,716,068 | B2 | 4/2004 | Wu |
| 6,428,328 | B2 | 8/2002 | Haba et al. | 6,717,825 | B2 | 4/2004 | Volstorf |
| 6,431,914 | B1 | 8/2002 | Billman | 6,726,492 | B1 | 4/2004 | Yu |
| 6,431,921 | B2 | 8/2002 | Saito et al. | 6,736,664 | B2 | 5/2004 | Ueda et al. |
| 6,435,914 | B1 | 8/2002 | Billman | 6,739,910 | B1 | 5/2004 | Wu |
| 6,450,829 | B1 | 9/2002 | Weisz-Margulescu | 6,740,820 | B2 | 5/2004 | Cheng |
| 6,457,983 | B1 | 10/2002 | Bassler et al. | D492,295 | S | 6/2004 | Glatt |
| 6,461,183 | B1 | 10/2002 | Ohkita et al. | 6,743,037 | B2 | 6/2004 | Kassa et al. |
| 6,461,202 | B2 | 10/2002 | Kline | 6,743,059 | B1 | 6/2004 | Korsunsky et al. |
| 6,464,529 | B1 | 10/2002 | Jensen et al. | 6,746,278 | B2 | 6/2004 | Nelson et al. |
| 6,471,523 | B1 | 10/2002 | Shuey | 6,749,439 | B1 | 6/2004 | Potter et al. |
| 6,471,548 | B2 | 10/2002 | Bertoncini et al. | 6,762,067 | B1 | 7/2004 | Quinones et al. |
| 6,472,474 | B2 | 10/2002 | Burkhardt et al. | 6,764,341 | B2 | 7/2004 | Lappoehn |
| 6,482,038 | B2 | 11/2002 | Olson | 6,769,883 | B2 | 8/2004 | Brid et al. |
| 6,485,330 | B1 | 11/2002 | Doutrich | 6,769,935 | B2 | 8/2004 | Stokoe et al. |
| 6,488,549 | B1 | 12/2002 | Weller et al. | 6,776,635 | B2 | 8/2004 | Blanchfield et al. |
| 6,489,567 | B2 | 12/2002 | Zachrai | 6,776,649 | B2 | 8/2004 | Pape et al. |
| 6,491,545 | B1 | 12/2002 | Spiegel et al. | 6,780,027 | B2 | 8/2004 | Allison et al. |
| 6,494,734 | B1 | 12/2002 | Shuey | 6,786,771 | B2 | 9/2004 | Gailus |
| 6,503,103 | B1 | 1/2003 | Cohen et al. | 6,790,088 | B2 | 9/2004 | Ono et al. |
| 6,506,076 | B2 | 1/2003 | Cohen et al. | 6,796,831 | B1 | 9/2004 | Yasufuku et al. |
| 6,506,081 | B2 | 1/2003 | Blanchfield et al. | 6,797,215 | B2 | 9/2004 | Bonk et al. |
| 6,514,103 | B2 | 2/2003 | Pape et al. | D497,343 | S | 10/2004 | Busse et al. |
| 6,517,360 | B1 | 2/2003 | Cohen | 6,805,278 | B1 | 10/2004 | Olson et al. |
| 6,520,803 | B1 | 2/2003 | Dunn | 6,808,399 | B2 | 10/2004 | Rothermel et al. |
| 6,526,519 | B1 | 2/2003 | Cuthbert | 6,808,420 | B2 | 10/2004 | Whiteman, Jr. et al. |
| 6,527,587 | B1 | 3/2003 | Ortega et al. | 6,810,783 | B1 | 11/2004 | Larose |
| 6,527,588 | B2 | 3/2003 | Paagman | 6,811,440 | B1 | 11/2004 | Rothermel et al. |
| 6,528,737 | B1 | 3/2003 | Kwong et al. | 6,814,590 | B2 | 11/2004 | Minich et al. |
| 6,530,134 | B1 | 3/2003 | Laphan et al. | 6,814,619 | B1 | 11/2004 | Stokoe et al. |
| 6,537,086 | B1 | 3/2003 | Mac Mullin | 6,824,391 | B2 | 11/2004 | Mickiewicz et al. |
| 6,537,111 | B2 | 3/2003 | Brammer et al. | 6,829,143 | B2 | 12/2004 | Russell et al. |
| 6,540,522 | B2 | 4/2003 | Sipe | 6,835,072 | B2 | 12/2004 | Simons et al. |
| 6,540,558 | B1 | 4/2003 | Paagman | 6,835,103 | B2 | 12/2004 | Middlehurst et al. |
| 6,540,559 | B1 | 4/2003 | Kemmick et al. | 6,843,686 | B2 | 1/2005 | Ohnishi et al. |
| 6,544,046 | B1 | 4/2003 | Hahn et al. | 6,843,687 | B2 | 1/2005 | McGowan et al. |
| 6,544,072 | B2 | 4/2003 | Olson | 6,846,202 | B1 | 1/2005 | Schmidt et al. |
| 6,547,066 | B2 | 4/2003 | Koch | 6,848,886 | B2 | 2/2005 | Schmaling et al. |
| 6,551,112 | B1 | 4/2003 | Li et al. | 6,848,944 | B2 | 2/2005 | Evans |
| 6,551,140 | B2 | 4/2003 | Billman et al. | 6,848,950 | B2 | 2/2005 | Allison et al. |
| 6,554,647 | B1 | 4/2003 | Cohen et al. | 6,848,953 | B2 | 2/2005 | Schell et al. |
| 6,565,387 | B2 | 5/2003 | Cohen | 6,851,974 | B2 | 2/2005 | Doutrich |
| 6,565,388 | B1 | 5/2003 | Van Woensel et al. | 6,851,980 | B2 | 2/2005 | Nelson et al. |
| 6,572,409 | B2 | 6/2003 | Nitta et al. | 6,852,567 | B1 | 2/2005 | Lee et al. |
| 6,572,410 | B1 | 6/2003 | Volstorf et al. | D502,919 | S | 3/2005 | Studnick, III |
| 6,575,774 | B2 | 6/2003 | Ling et al. | 6,866,549 | B2 | 3/2005 | Kimura et al. |
| 6,575,776 | B1 | 6/2003 | Conner et al. | 6,869,292 | B2 | 3/2005 | Johnescu et al. |
| 6,589,071 | B1 | 7/2003 | Lias et al. | 6,869,294 | B2 | 3/2005 | Clark et al. |
| 6,592,381 | B2 | 7/2003 | Cohen et al. | 6,872,085 | B1 | 3/2005 | Cohen et al. |
| 6,602,095 | B2 | 8/2003 | Astbury, Jr. et al. | 6,884,117 | B2 | 4/2005 | Korsunsky et al. |
| 6,604,967 | B2 | 8/2003 | Middlehurst et al. | 6,890,184 | B2 | 5/2005 | Doblar et al. |
| 6,607,402 | B2 | 8/2003 | Cohen et al. | 6,890,214 | B2 | 5/2005 | Brown et al. |
| 6,623,310 | B1 | 9/2003 | Billman et al. | 6,890,221 | B2 | 5/2005 | Wagner |
| 6,629,854 | B2 | 10/2003 | Murakami | 6,893,272 | B2 | 5/2005 | Yu |
| 6,633,490 | B2 | 10/2003 | Centola et al. | 6,893,300 | B2 | 5/2005 | Zhou et al. |
| 6,641,410 | B2 | 11/2003 | Marvin et al. | 6,893,686 | B2 | 5/2005 | Egan |
| 6,641,411 | B1 | 11/2003 | Stoddard et al. | 6,899,566 | B2 | 5/2005 | Kline et al. |
| 6,641,825 | B2 | 11/2003 | Scholz et al. | 6,902,411 | B2 | 6/2005 | Kubo |
| 6,652,318 | B1 | 11/2003 | Winings et al. | 6,905,367 | B2 | 6/2005 | Crane, Jr. et al. |
| 6,663,426 | B2 | 12/2003 | Hasircoglu et al. | 6,913,490 | B2 | 7/2005 | Whiteman, Jr. et al. |
| 6,665,189 | B1 | 12/2003 | Lebo | 6,918,776 | B2 | 7/2005 | Spink, Jr. |
| 6,666,693 | B2 | 12/2003 | Belopolsky et al. | 6,918,789 | B2 | 7/2005 | Lang et al. |
| 6,669,514 | B2 | 12/2003 | Wiebking et al. | 6,929,504 | B2 | 8/2005 | Ling et al. |
| 6,672,884 | B1 | 1/2004 | Toh et al. | 6,932,649 | B1 | 8/2005 | Rothermel et al. |
| 6,672,907 | B2 | 1/2004 | Azuma | 6,939,173 | B1 | 9/2005 | Elco et al. |
| 6,679,709 | B2 | 1/2004 | Takeuchi | 6,945,796 | B2 | 9/2005 | Bassler et al. |
| 6,692,272 | B2 | 2/2004 | Lemke et al. | 6,947,012 | B2 | 9/2005 | Aisenbrey |
| 6,695,627 | B2 | 2/2004 | Ortega et al. | 6,951,466 | B2 | 10/2005 | Sandoval et al. |
| 6,702,590 | B2 | 3/2004 | Zaderej et al. | 6,953,351 | B2 | 10/2005 | Fromm et al. |
| | | | | 6,969,268 | B2 | 11/2005 | Brunker |
| | | | | 6,969,280 | B2 | 11/2005 | Chien et al. |
| | | | | 6,975,511 | B1 | 12/2005 | Lebo et al. |
| | | | | 6,976,886 | B2 | 12/2005 | Winings et al. |

(56)

References Cited

U.S. PATENT DOCUMENTS

| | | | | | | |
|--------------|---------|-----------------------|-----------------|---------|-----------------------|---------|
| 6,979,202 B2 | 12/2005 | Benham et al. | 7,452,249 B2 | 11/2008 | Daily | |
| 6,979,215 B2 | 12/2005 | Avery et al. | 7,458,839 B2 | 12/2008 | Ngo | |
| 6,981,883 B2 | 1/2006 | Raistrick et al. | 7,467,955 B2 | 12/2008 | Raistrick et al. | |
| 6,988,902 B2 | 1/2006 | Winings et al. | 7,476,108 B2 | 1/2009 | Swain | |
| 6,994,569 B2 | 2/2006 | Minich et al. | 7,497,735 B2 | 3/2009 | Belopolsky | |
| 7,001,189 B1 | 2/2006 | McGowan et al. | 7,497,736 B2 | 3/2009 | Minich et al. | |
| 7,021,975 B2 | 4/2006 | Lappohn | 7,500,871 B2 | 3/2009 | Minich et al. | |
| 7,040,901 B2 | 5/2006 | Benham et al. | 7,503,804 B2 | 3/2009 | Minich | |
| 7,044,794 B2 | 5/2006 | Consoli et al. | 7,541,135 B2 | 6/2009 | Swain | |
| 7,059,892 B1 | 6/2006 | Trout | 7,549,897 B2 | 6/2009 | Fedder et al. | |
| 7,059,919 B2 | 6/2006 | Clark et al. | 7,553,182 B2 | 6/2009 | Buck et al. | |
| 7,065,871 B2 | 6/2006 | Minich et al. | 7,588,463 B2 | 9/2009 | Yamada et al. | |
| 7,070,464 B2 | 7/2006 | Clark et al. | 7,621,781 B2 | 11/2009 | Rothermel et al. | |
| 7,074,096 B2 | 7/2006 | Copper et al. | D607,822 S | 1/2010 | Dennes | |
| 7,086,147 B2 | 8/2006 | Caletka et al. | D611,908 S | 3/2010 | Takada et al. | |
| 7,090,501 B1 | 8/2006 | Scherer et al. | 7,708,569 B2 | 5/2010 | Sercu et al. | |
| 7,094,102 B2 | 8/2006 | Cohen et al. | D618,180 S | 6/2010 | Gross et al. | |
| 7,097,465 B1 | 8/2006 | Korsunsky et al. | D618,181 S | 6/2010 | Gross et al. | |
| 7,097,506 B2 | 8/2006 | Nakada | 7,753,731 B2 | 7/2010 | Cohen et al. | |
| 7,101,191 B2 | 9/2006 | Benham et al. | 7,762,843 B2 | 7/2010 | Minich et al. | |
| 7,101,228 B2 | 9/2006 | Hamner et al. | D626,075 S | 10/2010 | Truskett et al. | |
| 7,104,812 B1 | 9/2006 | Bogiel et al. | 7,833,065 B2 | 11/2010 | Lin et al. | |
| 7,108,556 B2 | 9/2006 | Cohen et al. | D628,963 S | 12/2010 | Sau et al. | |
| 7,114,963 B2 | 10/2006 | Shuey et al. | 7,883,366 B2 | 2/2011 | Davis et al. | |
| 7,114,964 B2 | 10/2006 | Winings et al. | 7,931,474 B2 | 4/2011 | Laurx et al. | |
| 7,118,391 B2 | 10/2006 | Minich et al. | 7,976,326 B2 | 7/2011 | Stoner | |
| RE39,380 E | 11/2006 | Davis | 7,988,456 B2 | 8/2011 | Davis et al. | |
| 7,131,870 B2 | 11/2006 | Whiteman, Jr. et al. | 8,011,957 B2 | 9/2011 | Pan | |
| 7,137,848 B1 | 11/2006 | Trout et al. | D651,177 S | 12/2011 | Luo | |
| 7,153,162 B2 | 12/2006 | Mizumura et al. | 8,079,847 B2 | 12/2011 | Davis et al. | |
| 7,160,151 B1 | 1/2007 | Rigby et al. | D653,621 S | 2/2012 | Gross et al. | |
| 7,163,421 B1 | 1/2007 | Cohen et al. | 8,109,770 B2 | 2/2012 | Perugini et al. | |
| 7,168,963 B2 | 1/2007 | Minich et al. | 8,119,926 B2 | 2/2012 | Murphy | |
| 7,172,461 B2 | 2/2007 | Davis et al. | 8,157,599 B2 | 4/2012 | Wei | |
| 7,182,608 B2 | 2/2007 | Soh et al. | 8,231,415 B2 | 7/2012 | Johnescu et al. | |
| 7,182,642 B2 | 2/2007 | Ngo et al. | 8,277,241 B2 | 10/2012 | Horchler et al. | |
| 7,182,643 B2 | 2/2007 | Winings et al. | 8,366,485 B2 | 2/2013 | Johnescu | |
| D540,258 S | 4/2007 | Peng et al. | 8,408,939 B2 | 4/2013 | Davis et al. | |
| 7,204,699 B2 | 4/2007 | Stoner | 8,414,199 B2 | 4/2013 | Ishigami | |
| 7,207,807 B2 | 4/2007 | Fogg | 8,465,213 B2 | 6/2013 | Tamura et al. | |
| D541,748 S | 5/2007 | Peng et al. | 8,480,413 B2 | 7/2013 | Minich et al. | |
| D542,736 S | 5/2007 | Riku | RE44,556 E | 10/2013 | Minich | |
| 7,220,141 B2 | 5/2007 | Daily et al. | D712,843 S | 9/2014 | Buck et al. | |
| 7,239,526 B1 | 7/2007 | Bibee | D714,227 S * | 9/2014 | Buck et al. | D13/154 |
| 7,241,168 B2 | 7/2007 | Sakurai et al. | D718,253 S * | 11/2014 | Zerebilov et al. | D13/154 |
| 7,258,562 B2 | 8/2007 | Daily et al. | D720,698 S | 1/2015 | Zerebilov et al. | |
| D550,158 S | 9/2007 | Victor | D727,268 S * | 4/2015 | Buck et al. | D13/154 |
| D550,628 S | 9/2007 | Whiteman, Jr. et al. | 2001/0003685 A1 | 6/2001 | Aritani | |
| 7,267,515 B2 | 9/2007 | Lappohn | 2001/0008189 A1 | 7/2001 | Reede | |
| 7,270,574 B1 | 9/2007 | Ngo | 2001/0012729 A1 | 8/2001 | Van Woensel | |
| 7,273,382 B2 | 9/2007 | Igarashi et al. | 2001/0041477 A1 | 11/2001 | Billman et al. | |
| 7,278,856 B2 | 10/2007 | Minich | 2001/0046810 A1 | 11/2001 | Cohen et al. | |
| 7,281,950 B2 | 10/2007 | Belopolsky | 2001/0046816 A1 | 11/2001 | Saito et al. | |
| D554,591 S | 11/2007 | Victor | 2002/0013101 A1 | 1/2002 | Long | |
| 7,292,055 B2 | 11/2007 | Egitto | 2002/0039857 A1 | 4/2002 | Naito et al. | |
| 7,303,427 B2 | 12/2007 | Swain | 2002/0084105 A1 | 7/2002 | Geng et al. | |
| 7,309,239 B2 | 12/2007 | Shuey et al. | 2002/0098727 A1 | 7/2002 | McNamara et al. | |
| 7,316,585 B2 | 1/2008 | Smith et al. | 2002/0106930 A1 | 8/2002 | Pape et al. | |
| 7,322,855 B2 | 1/2008 | Mongold et al. | 2002/0106932 A1 | 8/2002 | Holland et al. | |
| 7,331,802 B2 | 2/2008 | Rothermel et al. | 2002/0111068 A1 | 8/2002 | Cohen et al. | |
| 7,335,043 B2 | 2/2008 | Ngo et al. | 2002/0127903 A1 | 9/2002 | Billman et al. | |
| 7,338,321 B2 | 3/2008 | Laurx | 2002/0142629 A1 | 10/2002 | Zaderej et al. | |
| 7,347,740 B2 | 3/2008 | Minich | 2002/0142676 A1 | 10/2002 | Hosaka et al. | |
| 7,351,071 B2 | 4/2008 | Korsunsky et al. | 2002/0159235 A1 | 10/2002 | Müller et al. | |
| 7,381,092 B2 | 6/2008 | Nakada | 2002/0173177 A1 | 11/2002 | Korsunsky | |
| 7,384,289 B2 | 6/2008 | Minich | 2002/0187688 A1 | 12/2002 | Marvin et al. | |
| 7,384,311 B2 | 6/2008 | Sharf et al. | 2002/0193019 A1 | 12/2002 | Blanchfield et al. | |
| 7,402,064 B2 | 7/2008 | Daily | 2003/0116857 A1 | 6/2003 | Taniguchi et al. | |
| 7,407,387 B2 | 8/2008 | Johnescu | 2003/0119378 A1 | 6/2003 | Avery | |
| 7,422,483 B2 | 9/2008 | Avery et al. | 2003/0143894 A1 | 7/2003 | Kline et al. | |
| 7,425,145 B2 | 9/2008 | Ngo et al. | 2003/0171010 A1 | 9/2003 | Winings et al. | |
| 7,429,176 B2 | 9/2008 | Johnescu | 2003/0203665 A1 | 10/2003 | Ohnishi et al. | |
| 7,442,054 B2 | 10/2008 | Lemke et al. | 2003/0219999 A1 | 11/2003 | Minich et al. | |
| 7,445,457 B1 | 11/2008 | Frangioso, Jr. et al. | 2003/0220021 A1 | 11/2003 | Whiteman, Jr. et al. | |
| 7,452,242 B2 | 11/2008 | Poh et al. | 2003/0236035 A1 | 12/2003 | Kuroda et al. | |
| | | | 2004/0018757 A1 | 1/2004 | Lang et al. | |
| | | | 2004/0038590 A1 | 2/2004 | Lang et al. | |
| | | | 2004/0072470 A1 | 4/2004 | Lang et al. | |
| | | | 2004/0077224 A1 | 4/2004 | Marchese | |

(56)

References Cited

U.S. PATENT DOCUMENTS

| | | | | | |
|-----------------|---------|------------------|-----------------|--------------|------------------|
| 2004/0087196 A1 | 5/2004 | Lang et al. | 2013/0149881 A1 | 6/2013 | Johnescu et al. |
| 2004/0114866 A1 | 6/2004 | Hiramatsu | 2013/0149890 A1 | 6/2013 | Schroll et al. |
| 2004/0157477 A1 | 8/2004 | Johnson et al. | 2013/0195408 A1 | 8/2013 | Hermeline et al. |
| 2004/0224559 A1 | 11/2004 | Nelson et al. | 2013/0210246 A1 | 8/2013 | Davis et al. |
| 2004/0235321 A1 | 11/2004 | Mizumura et al. | 2013/0273756 A1 | 10/2013 | Stoner et al. |
| 2004/0259420 A1 | 12/2004 | Wu | 2013/0273781 A1 | 10/2013 | Buck et al. |
| 2005/0009402 A1 | 1/2005 | Chien et al. | 2014/0017957 A1 | 1/2014 | Horchler et al. |
| 2005/0026503 A1 | 2/2005 | Trout et al. | 2014/0227911 A1 | 8/2014 | Lim et al. |
| 2005/0032401 A1 | 2/2005 | Kobayashi | | | |
| 2005/0048838 A1 | 3/2005 | Korsunsky et al. | | | |
| 2005/0079763 A1 | 4/2005 | Lemke et al. | | | |
| 2005/0101166 A1 | 5/2005 | Kameyama | | | |
| 2005/0101188 A1 | 5/2005 | Benham et al. | | | |
| 2005/0112952 A1 | 5/2005 | Wang et al. | | | |
| 2005/0118869 A1 | 6/2005 | Evans | | | |
| 2005/0170700 A1 | 8/2005 | Shuey et al. | | | |
| 2005/0196987 A1 | 9/2005 | Shuey et al. | | | |
| 2005/0202722 A1 | 9/2005 | Regnier et al. | | | |
| 2005/0215121 A1 | 9/2005 | Tokunaga | | | |
| 2005/0227552 A1 | 10/2005 | Yamashita et al. | | | |
| 2005/0277315 A1 | 12/2005 | Mongold et al. | | | |
| 2005/0287869 A1 | 12/2005 | Kenny et al. | | | |
| 2006/0003620 A1 | 1/2006 | Daily et al. | | | |
| 2006/0014433 A1 | 1/2006 | Consoli et al. | | | |
| 2006/0024983 A1 | 2/2006 | Cohen et al. | | | |
| 2006/0024984 A1 | 2/2006 | Cohen et al. | | | |
| 2006/0046526 A1 | 3/2006 | Minich | | | |
| 2006/0051987 A1 | 3/2006 | Goodman et al. | | | |
| 2006/0068610 A1 | 3/2006 | Belopolsky | | | |
| 2006/0068641 A1 | 3/2006 | Hull et al. | | | |
| 2006/0073709 A1 | 4/2006 | Reid | | | |
| 2006/0116857 A1 | 6/2006 | Sevic et al. | | | |
| 2006/0121749 A1 | 6/2006 | Fogg | | | |
| 2006/0128197 A1 | 6/2006 | McGowan et al. | | | |
| 2006/0141818 A1 | 6/2006 | Ngo | | | |
| 2006/0183377 A1 | 8/2006 | Sinsheimer | | | |
| 2006/0192274 A1 | 8/2006 | Lee et al. | | | |
| 2006/0216969 A1 | 9/2006 | Bright et al. | | | |
| 2006/0228912 A1 | 10/2006 | Morlion et al. | | | |
| 2006/0232301 A1 | 10/2006 | Morlion et al. | | | |
| 2006/0281354 A1 | 12/2006 | Ngo et al. | | | |
| 2007/0004287 A1 | 1/2007 | Marshall | | | |
| 2007/0021002 A1 | 1/2007 | Laurx et al. | | | |
| 2007/0042639 A1 | 2/2007 | Manter et al. | | | |
| 2007/0071391 A1 | 3/2007 | Mazotti et al. | | | |
| 2007/0099455 A1 | 5/2007 | Rothermel et al. | | | |
| 2007/0099512 A1 | 5/2007 | Sato | | | |
| 2007/0183707 A1 | 8/2007 | Umezawa | | | |
| 2007/0183724 A1 | 8/2007 | Sato | | | |
| 2007/0202715 A1 | 8/2007 | Daily et al. | | | |
| 2007/0202747 A1 | 8/2007 | Sharf et al. | | | |
| 2007/0205774 A1 | 9/2007 | Minich | | | |
| 2007/0207641 A1 | 9/2007 | Minich | | | |
| 2007/0293084 A1 | 12/2007 | Ngo | | | |
| 2008/0032524 A1 | 2/2008 | Lemke et al. | | | |
| 2008/0045079 A1 | 2/2008 | Minich et al. | | | |
| 2008/0176453 A1 | 7/2008 | Minich et al. | | | |
| 2008/0232737 A1 | 9/2008 | Ishigami et al. | | | |
| 2008/0246555 A1 | 10/2008 | Kirk et al. | | | |
| 2008/0248670 A1 | 10/2008 | Daily et al. | | | |
| 2008/0316729 A1 | 12/2008 | Rothermel et al. | | | |
| 2009/0011643 A1 | 1/2009 | Amleshi et al. | | | |
| 2010/0055983 A1 | 3/2010 | Wu | | | |
| 2010/0093209 A1 | 4/2010 | Liu et al. | | | |
| 2010/0216342 A1 | 8/2010 | Lin | | | |
| 2010/0240233 A1 | 9/2010 | Johnescu et al. | | | |
| 2010/0291803 A1 | 11/2010 | Kirk | | | |
| 2011/0159744 A1 | 6/2011 | Buck | | | |
| 2011/0195593 A1 | 8/2011 | McGrath et al. | | | |
| 2012/0202363 A1 | 8/2012 | McNamara et al. | | | |
| 2012/0214343 A1 | 8/2012 | Buck et al. | | | |
| 2012/0289095 A1 | 11/2012 | Kirk | | | |
| 2013/0005160 A1 | 1/2013 | Minich | | | |
| 2013/0090025 A1 | 4/2013 | Trout et al. | | | |
| 2013/0122744 A1 | 5/2013 | Morgan et al. | | | |
| | | | DE | 3529218 | 2/1986 |
| | | | DE | 3605316 | 8/1987 |
| | | | DE | 4040551 | 4/1993 |
| | | | DE | 10226279 | 11/2003 |
| | | | DE | 102010005001 | 8/2010 |
| | | | EP | 0212764 | 3/1987 |
| | | | EP | 0273683 | 7/1988 |
| | | | EP | 0337634 | 10/1989 |
| | | | EP | 0442785 | 8/1991 |
| | | | EP | 0486298 | 5/1992 |
| | | | EP | 0321257 | 4/1993 |
| | | | EP | 0560550 | 9/1993 |
| | | | EP | 0562691 | 9/1993 |
| | | | EP | 0591772 | 4/1994 |
| | | | EP | 0623248 | 11/1995 |
| | | | EP | 0706240 | 4/1996 |
| | | | EP | 0782220 | 7/1997 |
| | | | EP | 0789422 | 8/1997 |
| | | | EP | 0843383 | 5/1998 |
| | | | EP | 0635910 | 6/2000 |
| | | | EP | 1024556 | 8/2000 |
| | | | EP | 1111730 | 6/2001 |
| | | | EP | 0891016 | 10/2002 |
| | | | EP | 1091449 | 9/2004 |
| | | | EP | 1148587 | 4/2005 |
| | | | GB | 1162705 | 8/1969 |
| | | | JP | 57/058115 | 4/1982 |
| | | | JP | 60/072663 | 4/1985 |
| | | | JP | 02/278893 | 11/1990 |
| | | | JP | 0521119 | 1/1993 |
| | | | JP | 05344728 | 12/1993 |
| | | | JP | 0668943 | 3/1994 |
| | | | JP | 06236788 | 8/1994 |
| | | | JP | 07114958 | 5/1995 |
| | | | JP | 07169523 | 7/1995 |
| | | | JP | 0896918 | 4/1996 |
| | | | JP | 08125379 | 5/1996 |
| | | | JP | 09199215 | 7/1997 |
| | | | JP | 11185886 | 7/1999 |
| | | | JP | 2000/003743 | 1/2000 |
| | | | JP | 2000/003744 | 1/2000 |
| | | | JP | 2000/003745 | 1/2000 |
| | | | JP | 2000/003746 | 1/2000 |
| | | | JP | 2000/228243 | 8/2000 |
| | | | JP | 2001/135388 | 5/2001 |
| | | | JP | 2001/305182 | 10/2001 |
| | | | JP | 2002/008790 | 1/2002 |
| | | | JP | 2003/217785 | 7/2003 |
| | | | JP | 2007/128706 | 5/2007 |
| | | | KR | 100517561 | 9/2005 |
| | | | TW | 576555 | 8/1990 |
| | | | TW | 546872 | 8/2003 |
| | | | WO | 90/16093 | 12/1990 |
| | | | WO | 96/38889 | 12/1996 |
| | | | WO | 96/42123 | 12/1996 |
| | | | WO | 97/20454 | 6/1997 |
| | | | WO | 97/43885 | 11/1997 |
| | | | WO | 97/44859 | 11/1997 |
| | | | WO | 97/45896 | 12/1997 |
| | | | WO | 98/15989 | 4/1998 |
| | | | WO | 00/16445 | 3/2000 |
| | | | WO | 01/29931 | 4/2001 |
| | | | WO | 01/39332 | 5/2001 |
| | | | WO | 02/058191 | 7/2002 |
| | | | WO | 02/101882 | 12/2002 |
| | | | WO | 02/103847 | 12/2002 |
| | | | WO | 2005/065254 | 7/2005 |
| | | | WO | 2006/031296 | 3/2006 |

(56)

References Cited

FOREIGN PATENT DOCUMENTS

| | | |
|----|----------------|---------|
| WO | WO 2006/105535 | 10/2006 |
| WO | WO 2007/064632 | 6/2007 |
| WO | WO 2008/082548 | 7/2008 |
| WO | WO 2008/117180 | 10/2008 |
| WO | WO 2012/047619 | 4/2012 |
| WO | WO 2012/174120 | 12/2012 |

OTHER PUBLICATIONS

- U.S. Appl. No. 29/418,310, filed Apr. 13, 2012, Buck et al.
 U.S. Appl. No. 29/426,921, filed Jul. 11, 2012, Horchler.
 U.S. Appl. No. 29/444,125, filed Jan. 25, 2013, Harper, Jr. et al.
 U.S. Appl. No. 29/504,773, filed Oct. 9, 2014, Horchler.
 U.S. Appl. No. 29/517,389, filed Feb. 12, 2015, Buck et al.
 "1.0 HDMI Right Angle Header Assembly (19 Pin) Lead Free", Molex Incorporated, Jul. 20, 2004, 7 pages.
 "1.90 by 1.35mm (.075 by.053) Pitch Impact, Backplane Connector System 3 and 4 Pair, Features and Specification", Molex, www.molex.com/link/Impact.html, 2008, 5 pages.
 "4.0 UHD Connector Differential Signal Crosstalk, Reflections", 1998, p. 8-9.
 Ahn et al., "A Design of the Low-Pass Filter Using the Novel Microstrip Defected Ground Structure", IEEE Transactions on Microwave Theory and Techniques, 2001, 49(1), 86-93.
 "AMP Z-Dok and Z-Dok and Connectors", Tyco Electronics/AMP, Application Specification #114-13068, Aug. 30, 2005, 17 pages.
 "AMP Z-Pack 2mm Hm Connector, 2mm Centerline, Eight-Row, Right-Angle Applications", Electrical Performance Report, EPR 889065, Issued Sep. 1998, 59 pages.
 "AMP Z-Pack 2mm HM Interconnection System", 1992/1994, AMP Incorporated, 6 pages.
 "AMP Z-Pack Hm-Zd Performance at Gigabit Speeds", Tyco Electronics, Report #20GC014, Rev.B., May 4, 2001, 32 pages.
 "B.? Bandwidth and Rise Time Budgets, Module 1-8 Fiber Optic Telecommunications (E-XVI-2a)", http://cord.org-step online-st1-8-st18exvi2a.htm, 2006, 1-3.
 "Backplane Connectors", http://www.amphenol-tcs.com/products/connectors/backplane/index.html, Amphenol TCS (ATCS), Jun. 19, 2008, 1-3.
 Berg Electronics Catalog, p. 13-96, Solder Washers, 1996, 1 page.
 "Champ Z-Dok Connector System", Tyco Electronics, Jan. 2002, 3 pages.
 Chen et al., "Characteristics of Coplanar Transmission Lines on Multilayer Substrates: Modeling and Experiments", IEEE Transactions on Microwave Theory and Techniques, Jun. 1997, 45(6), 939-945.
 Cheng et al., "Terahertz-Bandwidth Characteristics of Coplanar Transmission Lines on Low Permittivity Substrates", IEEE Transactions on Microwave Theory and Techniques, 1994, 42(12), 2399-2406.
 Chua et al., "Broadband Characterisation of CPW Transition and Transmission Line Parameters for Small Reflection Up to 100 GHz", RF and Microwave Conference, 2004, 269-271.
 "Daughtercard Hole Pattern: Signal Modules (10 & 25 positions) Connector Assembly", Customer No. C-163-5101-500, Teradyne Connection Systems, Inc., 2001, 1 page.
 Derman "Speed, Density Push Design Complexities," Electronic Engineering Times, May 1998, 2 pages.
 European Patent Application No. 12305119.5: European Search Report dated Jul. 11, 2012, 5 pages.
 European Patent Application No. 10753953.8: Extended European Search Report dated Nov. 7, 2013, 6 pages.
 "FCI's Airmax VS Connector System Honored at DesignCon 2005", http://www.heilind.com-products-fci-armax-vs-design.asp, Heilind Electronics, Inc., 2005, 1 page.
 Finan, "Thermally Conductive Thermoplastics", LNP Engineering Plastics, Inc., Plastics Engineering 2000, www.4spe.org, 4 pages.
 "Framatome Connector Specification", May 10, 1999, 1 page.
 Fusi et al., "Differential Signal Transmission through Backplanes and Connectors", Electronic Packaging and Production, Mar. 1996, 27-31.
 "GbXI-Trac Backplane Connector System", www.molex.com/cgi-bin, Molex, 2007, 1-3.
 "Gig-Array Connector System, Board to Board Connectors", 2005, 4 pages.
 "Gig-Array High Speed Mezzanine Connectors 15-40 mm Board to Board", FCI Corporation, Jun. 5, 2006, 1 page.
 Goel et al., "Amp Z-Pack Interconnect System", Amp Incorporated, 1990, 9 pages.
 "HDM Separable Interface Detail", Molex, Feb. 17, 1993, 3 pages.
 "HDM Stacker Signal Integrity", http://www.teradyne.com/prods/tcs/products/connectors/mezzanine/hdm_stacker/signintegrity.html, Amphenol TCS (ATCS), Feb. 2, 2006, 3 pages.
 "HDM, HDM Plus Connectors", http://www.teradyne.com-prods-tcs-products-connectors-backplane-hdm-index.html, Amphenol TCS, 2006, 1 page.
 "HDM/HDM Plus, 2mm, Backplane Interconnection System", Teradyne Connection Systems, 1993, 22 pages.
 Hettak et al., "Simultaneous Realization of Millimeter Wave Uniplanar Shunt Stubs and DC Block", IEEE MTT-S Digest, 1998, 809-812.
 "High Definition Multimedia Interface (HDMI)", www.molex.com, Molex, Jun. 19, 2008, 2 pages.
 "High Speed Backplane Interconnect Solutions", Tyco Electronics, 2007, 6 pages.
 "High Speed Characterization Report, SEAM-30-02.0-S-10-2", www.samtec.com, SAMTEC, 2005, 55 pages.
 "Honda High-Speed Backplane Connector NSP Series", Honda Connectors, Feb. 7, 2003, 25 pages.
 Hult, "FCI's Problem Solving Approach Changes Market, The FCI Electronics AirMax VS", http://www.connectorupplier.com-tech updates FCI-AirMax archive.htm, ConnectorSupplier.com, 2006, 1-4.
 Hunsaker, "Ventura Application Design", TB-2127, Amphenol, Aug. 25, 2005, 13 pages.
 IBM Technical Disclosure Bulletin, 1972, 14(8), 2 pages.
 IBM Technical Disclosure Bulletin, 1977, 20(2), 2 pages.
 IBM Technical Disclosure Bulletin, 1990, 32(11), 2 pages.
 "Impact 3 Pair 10 Column Signal Module", Tyco Electronics, Mar. 25, 2008, 1 page.
 "Impact 3 Pair Header Unguided Open Assembly", Tyco Electronics, Apr. 11, 2008, 1 page.
 "Impact Connector Offered by Tyco Electronic, High Speed Backplane Connector System", Tyco Electronics, Apr. 15, 2008, 12 pages.
 International Application No. PCT/US2003/014370, International Search Report dated Aug. 6, 2003, 2 pages.
 International Application No. PCT/US2010/040899, International Search Report dated Jan. 25, 2011, 2 pages.
 International Patent Application No. PCT/US2013/035775: International Search Report dated Jul. 18, 2013, 3 pages.
 International Patent Application No. PCT/US2013/035915: International Search Report and Written Opinion dated Jul. 25, 2013, 17 pages.
 International Patent Application No. PCT/US2013/049995: International Search Report dated Oct. 28, 2013, 18 pages.
 Kazmierowicz, "Profiling Your Solder Reflow Oven in Three Passes or Less", KIC Oven Profiling, Surface Mount Technology, 1990, 2 pages.
 Kazmierowicz, "The Science Behind Conveyor Oven Thermal Profiling", KIC Oven Profiling, Surface Mount Technology, 1990, 9 pages.
 Lee et al., "Characteristic of the Coplanar Waveguide to Microstrip Right-Angled Transition", Department of Electronics Engineering, 1998, 3 pages.
 Leung et al., "Low-Loss Coplanar Waveguides Interconnects on Low-Resistivity Silicon Substrate", IEEE Transactions on Components and Packaging Technologies, 2004, 27(3), 507-512.
 Lim et al., "A Spiral-Shaped Defected Ground Structure for Coplanar Waveguide", IEEE Microwave and Wireless Components Letters, 2002, 12(9), 330-332.

(56)

References Cited

OTHER PUBLICATIONS

- "Lucent Technologies' Bell Labs and FCI Demonstrate 25gb-S Data Transmission Over Electrical Backplane Connectors", <http://www.lucent.com-press-0205-050201.bla.html>, Lucent Tech Bell Labs, Feb. 1, 2005, 1-4.
- Machac et al., "Space Leakage of Power from Uniplanar Transmission Lines", Czech Technical University, 565-568.
- Mao et al., "Characterization of Coplanar Waveguide Open End Capacitance-Theory and Experiment", IEEE Transactions on Microwave Theory and Techniques, 1994, 42(6), 1016-1024.
- "Metral 1000 Series, 5 Row Receptacle, Right Angle, Press Fit, PCB Mounted Receptacle Assembly", FCI 2001, 1 page.
- "Metral 2mm High-Speed Connectors, 1000, 2000, 3000 Series, Electrical Performance Data for Differential Applications", FCI Framatome Group, 2000, 2 pages.
- "Metal Speed & Density Extensions", FCI, Jun. 3, 1999, 1-25.
- "Mezzanine High Speed High-Density Connectors Gig-Array and Meg-Array Electrical Performance Data", FCI Corporation, 10 pages.
- "Micro Electronic Interconnects", Alphametals, 1990, 4 pages.
- "MILLIPACS Connector, Type A Specification", Dec. 14, 2004, 1 page.
- Mottonen et al., "Novel Wide-Band Coplanar Waveguide-to-Rectangular Waveguide Transition", IEEE Transactions on Microwave Theory and Techniques, 2004, 52(8), 1836-1842.
- Nadolny et al., "Optimizing Connector Selection for Gigabit Signal Speeds", <http://www.ecnmaq.com-article-CA45245>, ECN, Sep. 1, 2000, 6 pages.
- "NSP Series, Backplane High-Speed Data Transmission Cable Connectors", <http://www.honda-connectors.co.jp>, Honda Connectors, 2006, 6 pages, English Translation attached.
- Ogando, "And now-An Injection-Molded Heat Exchanger", Sure, plastics are thermal insulators, but additive packages allow them to conduct heat instead, Global Design News, Nov. 1, 2000, 4 pages.
- "Open Pin Field Array Seaf Series", www.samtec.com, SAMTEC, 2005, 1 page.
- "Overview for High Density Backplane Connector (Z-Pack TinMan)", Tyco Electronics, 2008, 1 page.
- "Overview for High Density Backplane Connectors (Impact) Offered by Tyco Electronics", www.tycoelectronics.com/catalog, Tyco Electronics, 2007, 1-2.
- "Overview: Backplane Products", http://www.molex.com/cgi-bin/bv-molex-super-family-super-family.jsp?BV_SessionID=@, Molex, Feb. 8, 2006, 4 pages.
- "PCB-Mounted Receptacle Assemblies, 2.00 mm (0.079 in) Centerlines, Right-Angle Solder-to-Board Signal Receptacle", Metral, Berg Electronics, 2 pages.
- Power TwinBlade I/O Cable Connector RA-North-South, No. GS-20_072, Aug. 6, 2007, 11 pages.
- "Product Datasheets, 10 Bgit/s XENPAK 850 nm Transponder (TRP10GVP2045)", MergeOptics GmbH, 2005, 13 pages.
- "Product Datasheets, Welcome to XENPAK.org.", <http://www.xenpak.org>, 2001, 1 page.
- Research Disclosure, Kenneth Mason Publications Ltd., England, Aug. 1990, No. 316, 1 page.
- Research Disclosure, Kenneth Mason Publications Ltd., England, Oct. 1992, No. 342, 1 page.
- Sherman, "Plastics that Conduct Heat", Plastics Technology Online, Jun. 2001, <http://www.plasticstechnology.com>, 4 pages.
- Siemens, "SpeedPac: A New Concept for the Next Generation of Transmission Speed," Backplane Interconnection, Issue 1/96.
- Soliman et al., "Multimodel Characterization of Planar Microwave Structures", IEEE Transactions on Microwave Theory and Techniques, 2004, 52(1), 175-182.
- Son et al., "Picosecond Pulse Propagation on Coplanar Striplines Fabricated on Lossy Semiconductor Substrates: Modeling and Experiments", IEEE Transactions on Microwave Theory and Techniques, 1993, 41(9), 1574-1580.
- Straus, "Shielded In-Line Electrical Multiconnector", IBM Technical Disclosure Bulletin, Aug. 3, 1967, 10(3), 3 pages.
- Suh et al., "Coplanar Strip Line Resonators Modeling and Applications to Filters", IEEE Transactions on Microwave Theory and Techniques, 2002, 50(5), 1289-1296.
- "Two-Piece, High-Speed Connectors", www.tycoelectronics.com/catalog, Tyco Electronics, 2007, 1-3.
- "Tyco Unveils Z-Pack TinMan Orthogonal Connector System", <http://www.epn-online.com/page/new59327/tyco-unveils-z-pack-orthogonal-conn>, Oct. 13, 2009, 4 pages.
- Tzuang et al., "Leaky Mode Perspective on Printed Antenna", Proc. Natl. Sci. Counc. ROC(A), 1999, 23(4), 544-549.
- "Ventura High Performance, Highest Density Available", <http://www.amphenol-tcs.com/products/connectors/backplane/ventura/index.html>, Amphenol TCS (ATCS), Jun. 19, 2008, 1-2.
- "VHDM Connector", <http://www.teradyne.com/prods/tcs/products/connectors/backplane/vhdm/index.html>, Amphenol TCS (ATCS), Jan. 31, 2006, 2 pages.
- "VHDM Daughterboard Connectors Feature Press-Fit Terminations and a Non-Stubbing Separable Interface", Teradyne, Inc. Connections Sys Div, Oct. 8, 1997, 46 pages.
- "VHDM High-Speed Differential (VHDM HSD)", <http://www.teradyne.com/prods/bps/vhdm/hsd.html>, Teradyne, Jan. 24, 2000, 6 pages.
- "VHDM L-Series Connector", <http://www.teradyne.com/prods/tcs/products/connectors/backplane/vhdm-1-series/index.html>, Amphenol TCS(ATCS), 2006, 4 pages.
- Weller et al., "High Performance Microshield Line Components", IEEE Transactions on Microwave Theory and Techniques, 1995, 43(3), 534-543.
- Williams et al., "Accurate Transmission Line Characterization", IEEE Microwave and Guided Wave Letters, 1993, 3(8), 247-249.
- Wu et al., "Full-Wave Characterization of the Mode Conversion in a Coplanar Waveguide Right-Angled Bend", IEEE Transactions on Microwave Theory and Techniques, 1995, 43(11), 2532-2538.
- "XCede® Connector", <http://www.amphenol-tcs.com/products/connectors/backplane/xcede/index.html>, Amphenol TCS (ATCS), Jun. 19, 2008, 1-5.
- Ya et al., "Microstrip and Slotline Two-Pole Microwave Filters with Additional Transmission Zeros", Int. Crimean Conference, Microwave & Telecommunication Technology, 2004, 405-407 (English Abstract provided).
- "Z-Dok and Connector", <http://2dok.tyco.electronics.com>, Tyco Electronics, May 23, 2003, 1-15.
- "Z-Pack Slim UHD", <http://www.zpackuhd.com>, Tyco Electronics, 2007, 8 pages.
- "Z-Pack TinMan High Speed Orthogonal Connector Product Feature Selector", Tyco Electronics, 2009, 2 pages.
- "Z-Pack TinMan Product Portfolio Expanded to Include 6-Pair Module", Tyco Electronics, Jun. 19, 2008, 1 page.

* cited by examiner

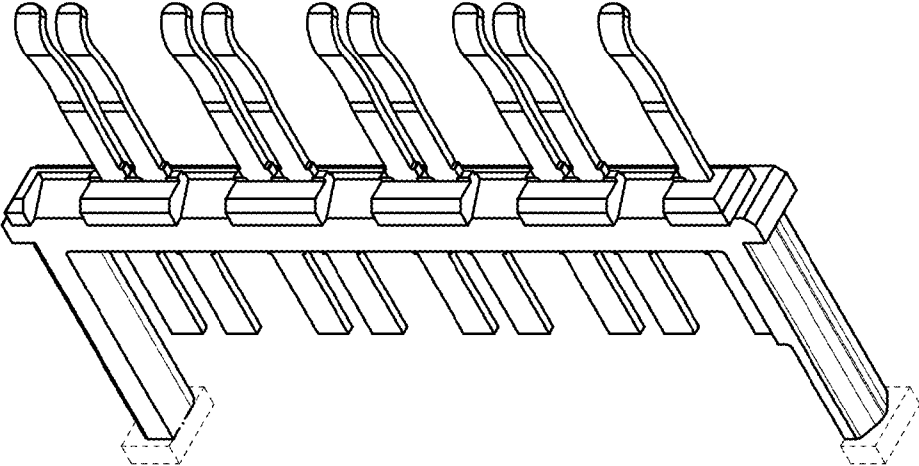

Fig.2

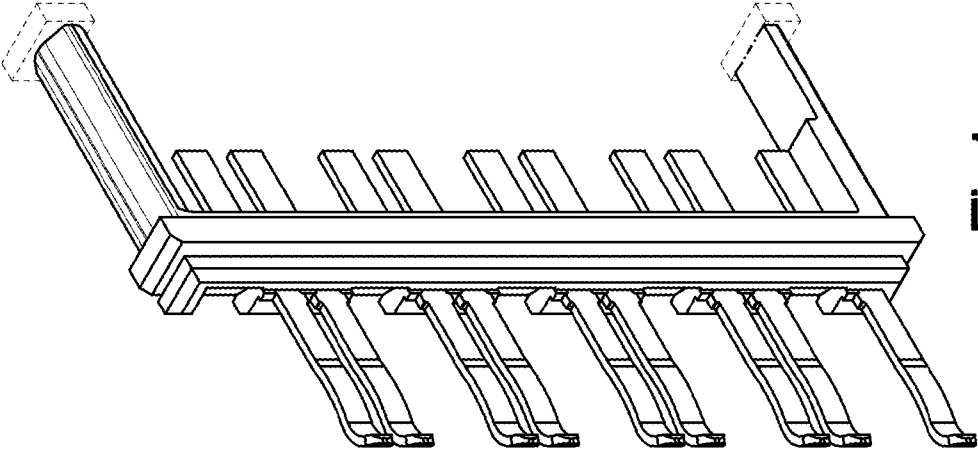

Fig.1

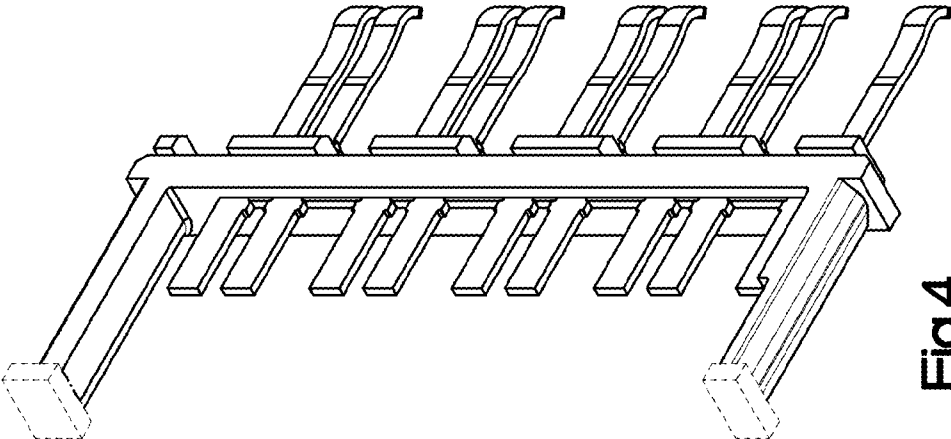

Fig.4

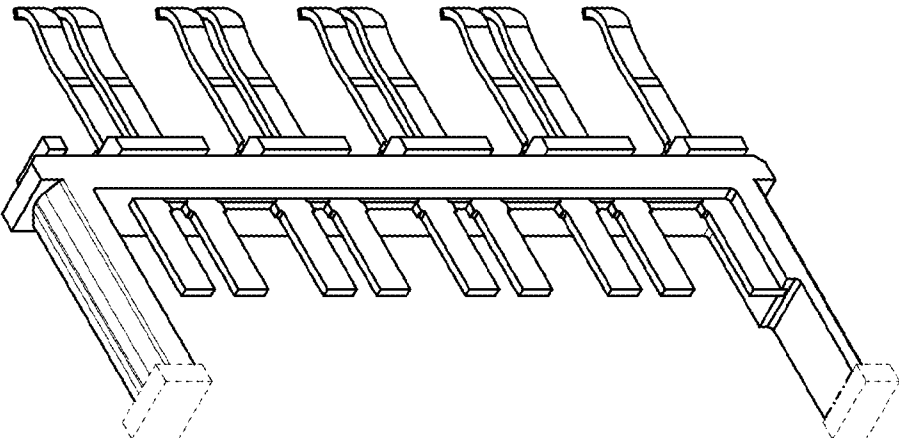

Fig.3

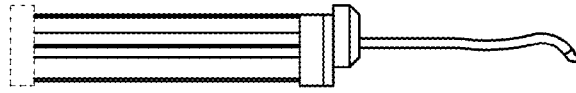

Fig.8

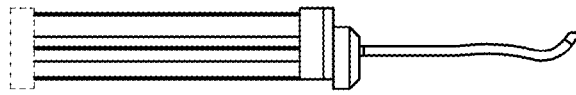

Fig.7

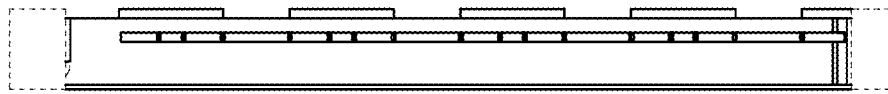

Fig.6

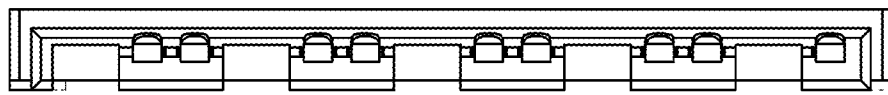

Fig.5

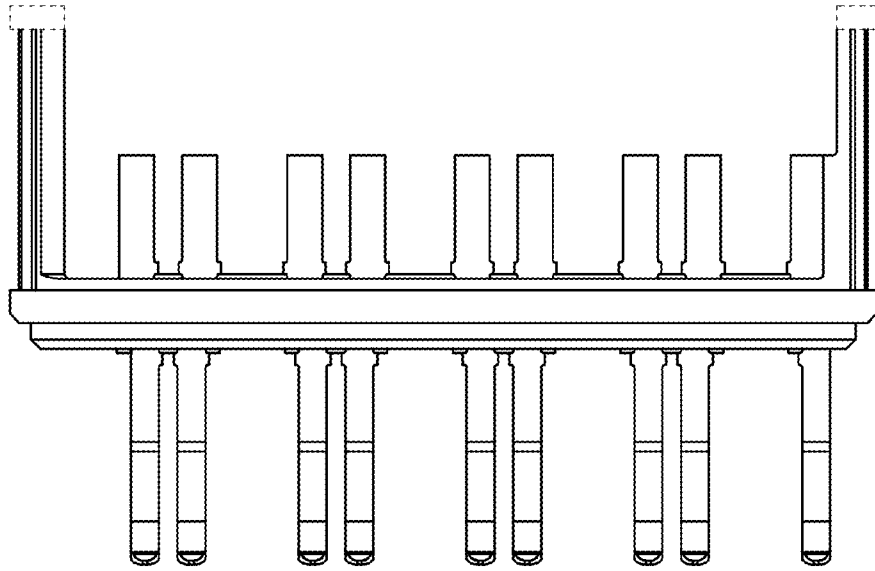

Fig.10

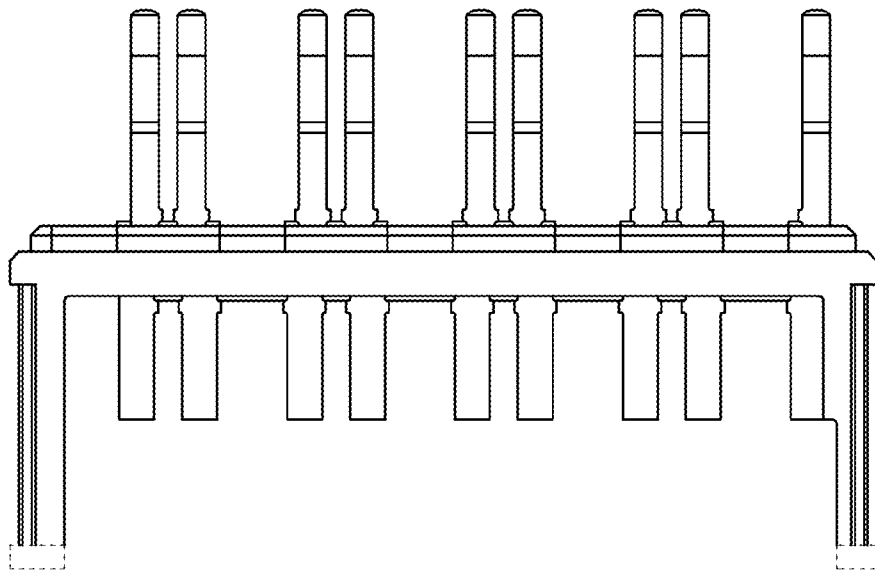

Fig.9

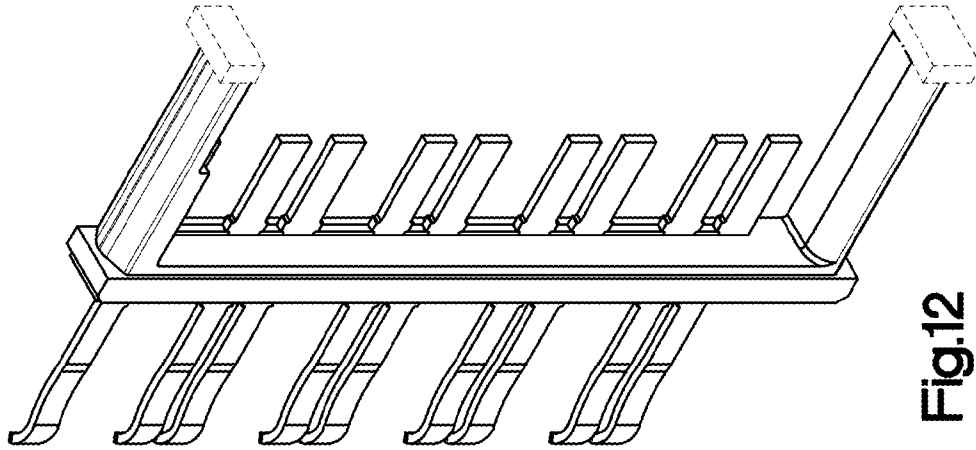

Fig.12

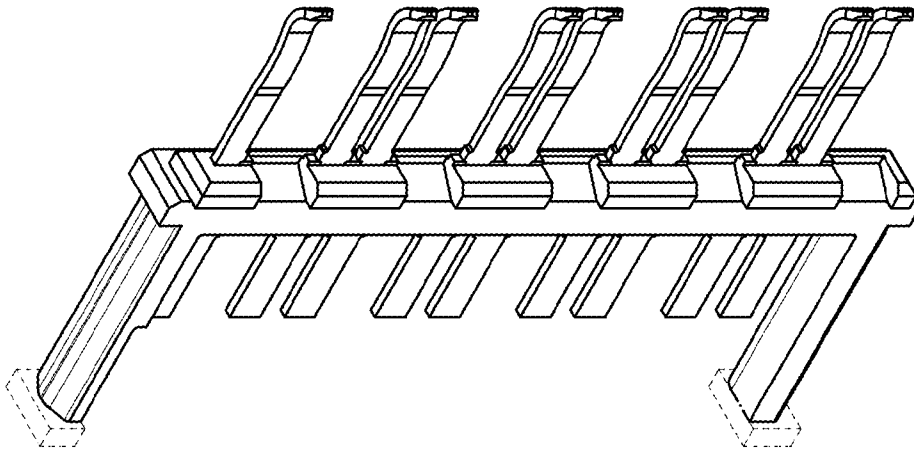

Fig.11

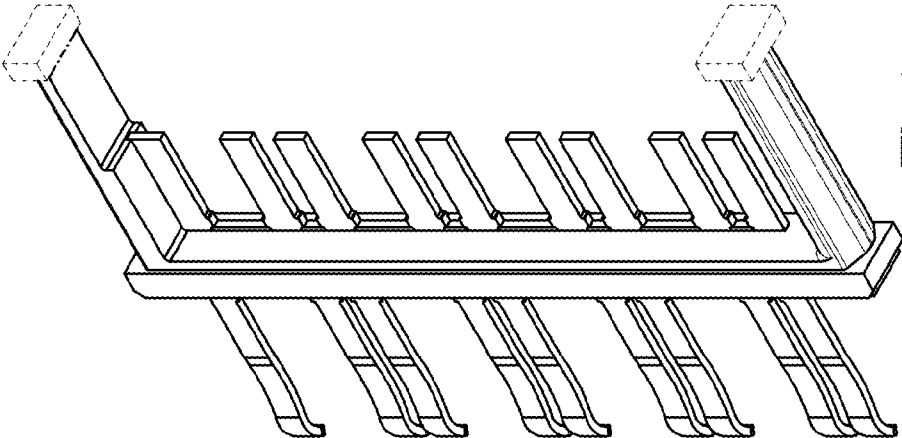

Fig.14

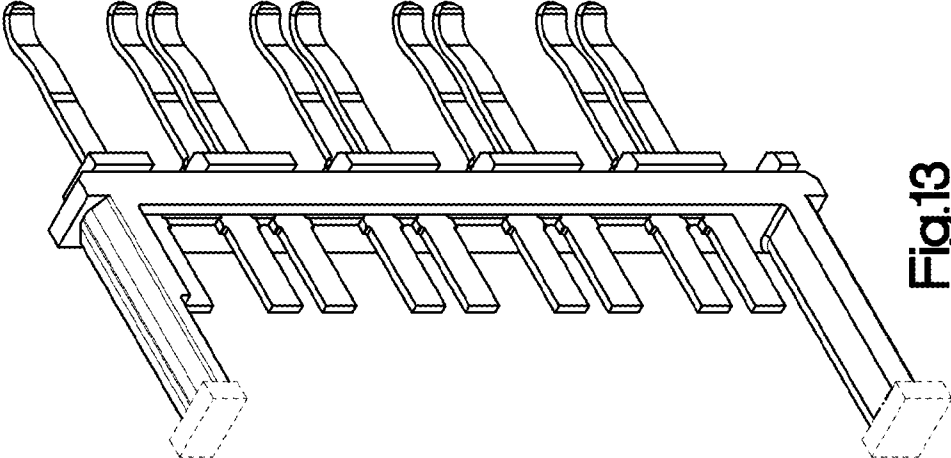

Fig.13

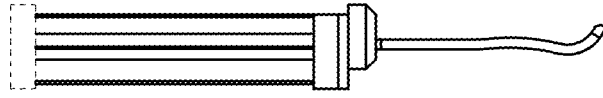

Fig.18

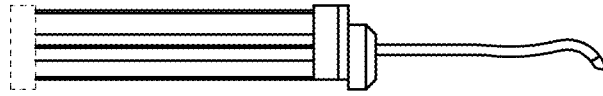

Fig.17

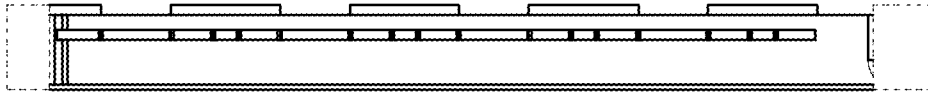

Fig.16

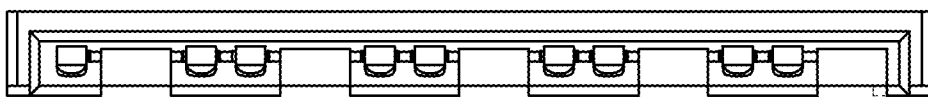

Fig.15

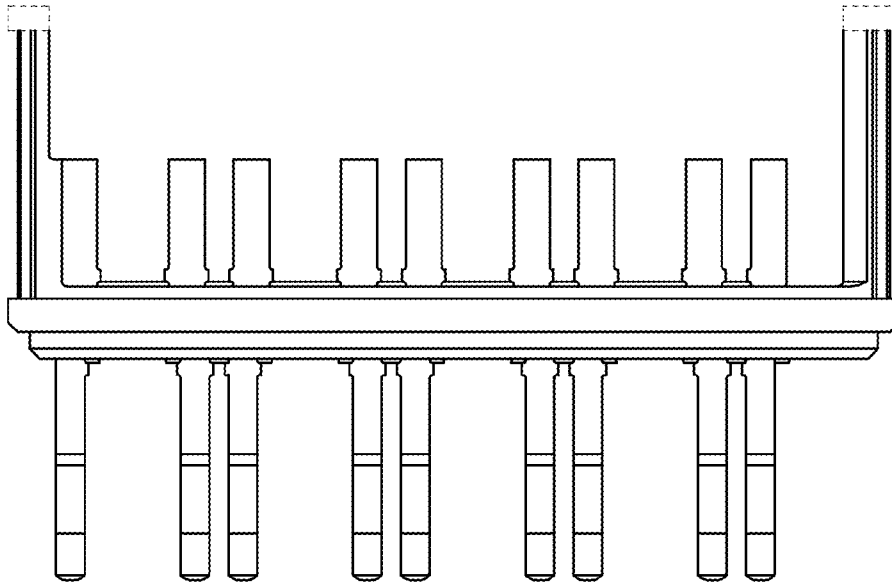

Fig.20

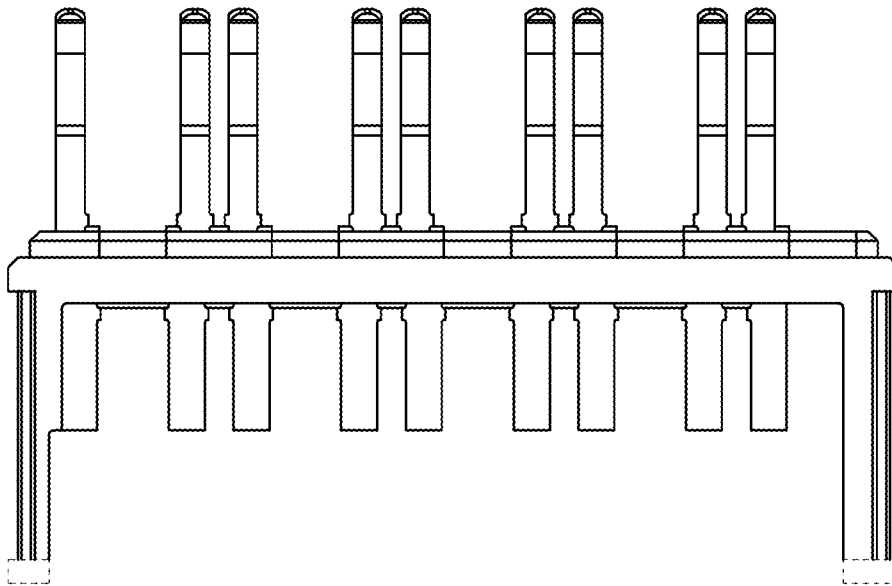

Fig.19