



US00D748162S

(12) **United States Design Patent**  
**McConnell et al.**

(10) **Patent No.:** **US D748,162 S**

(45) **Date of Patent:** **\*\* Jan. 26, 2016**

(54) **APPLIANCE INTERIOR WITH COLOR**

(71) Applicant: **Whirlpool Corporation**, Benton Harbor, MI (US)

(72) Inventors: **Jessica R. McConnell**, St. Joseph, MI (US); **Daniel Henry Quinlan**, Stevensville, MI (US); **Kelly E. Roche**, St. Joseph, MI (US); **Michael S. Seeley**, South Haven, MI (US)

(73) Assignee: **Whirlpool Corporation**, Benton Harbor, MI (US)

(\*\*) Term: **14 Years**

(21) Appl. No.: **29/485,366**

(22) Filed: **Mar. 18, 2014**

(51) **LOC (10) Cl.** ..... **15-07**

(52) **U.S. Cl.**  
USPC ..... **D15/89**

(58) **Field of Classification Search**

USPC ..... D15/79, 81, 84, 85, 86, 88, 89, 91  
CPC ..... F25D 2323/02; F25D 2323/021; F25D 2317/06; F25D 2317/062; F25D 2323/121; F25D 2323/122; F25D 2331/806; F25D 2400/36; F25D 13/02; F25D 13/04; F25D 11/02; F25D 11/025

See application file for complete search history.

(56) **References Cited**

**U.S. PATENT DOCUMENTS**

D508,249 S *	8/2005	Seok et al.	.....	D15/86
D511,177 S *	11/2005	Jackovin et al.	.....	D15/89
D511,179 S *	11/2005	Tunzi	.....	D15/89
D518,832 S *	4/2006	Park et al.	.....	D15/85
D629,819 S *	12/2010	Placke et al.	.....	D15/89
D639,315 S *	6/2011	Yang et al.	.....	D15/85
D647,927 S *	11/2011	Lee et al.	.....	D15/85
D654,515 S *	2/2012	Hwang et al.	.....	D15/85

(Continued)

*Primary Examiner* — Ian Simmons  
*Assistant Examiner* — Khawaja Anwar

(57) **CLAIM**

We claim the ornamental design for an appliance interior with color, as shown and described.

**DESCRIPTION**

FIG. 1 is a perspective view of an appliance interior with color in a closed configuration according to our design; FIG. 2 is a front elevation view thereof; FIG. 3 is a left side elevation view thereof; FIG. 4 is a top plan view thereof; FIG. 5 is a bottom plan view thereof; FIG. 6 is a front elevation view of the appliance interior with color of FIG. 1 shown in an open configuration; FIG. 7 is an enlarged top left perspective view thereof; FIG. 8 is an enlarged top right perspective view thereof; FIG. 9 is a front elevation view thereof; FIG. 10 is a partial left perspective view thereof; FIG. 11 is a partial front elevation view thereof; FIG. 12 is a partial left perspective view thereof in a first use condition of the open configuration; FIG. 13 is a partial front elevation view of a right portion thereof; FIG. 14 is a partial right perspective view thereof; FIG. 15 is a partial front elevation view thereof; FIG. 16 is a partial right perspective view thereof in a second use condition of the open configuration; and, FIG. 17 is a partial front elevation view thereof. The broken lines in the figures are to show an environment and form no part of the claimed design. Dash-dot lines adjacent un-shaded areas represent bounds of the claimed design and form no part of the claimed design themselves.

The dark tone fill within the bounded area on is used to indicate a charcoal gray color having the following characteristics:

H: 0  
S: 0  
V: 28 (+/-5%).

**1 Claim, 16 Drawing Sheets**

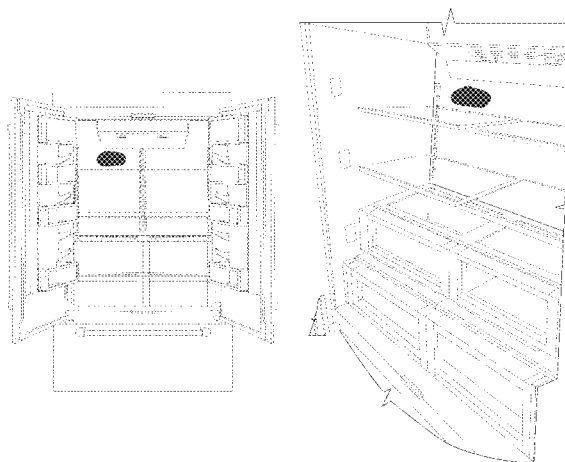

(56)

**References Cited**

U.S. PATENT DOCUMENTS

D655,321 S *	3/2012	Lee et al. ....	D15/86	D710,402 S *	8/2014	Jeon et al. ....	D15/86
D707,735 S *	6/2014	Cho et al. ....	D15/91	D716,851 S *	11/2014	Seo et al. ....	D15/89
D710,401 S *	8/2014	Ringemann et al. ....	D15/85	D718,346 S *	11/2014	Cho et al. ....	D15/81
				D718,349 S *	11/2014	Cho et al. ....	D15/85

\* cited by examiner

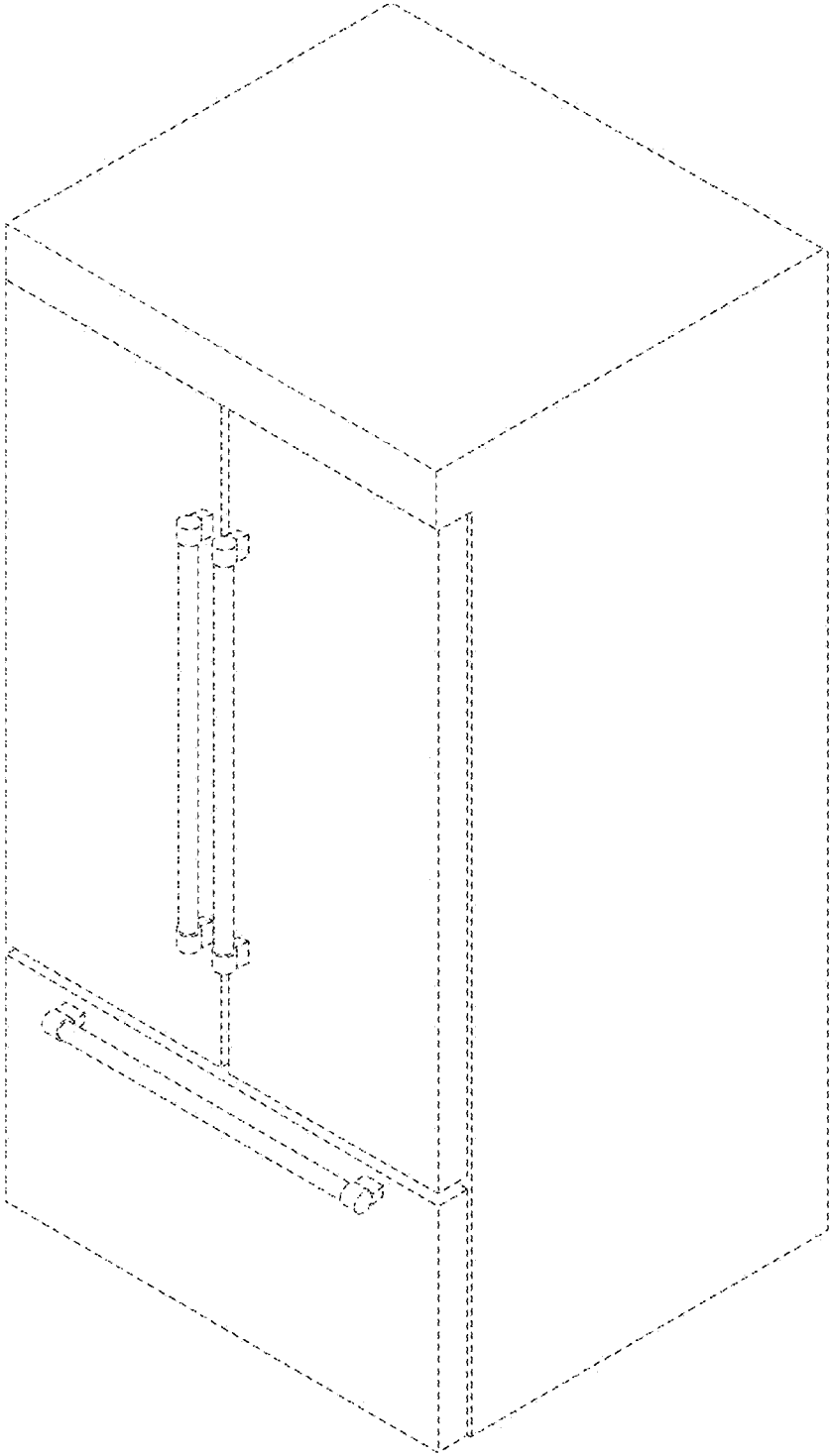

FIG. 1

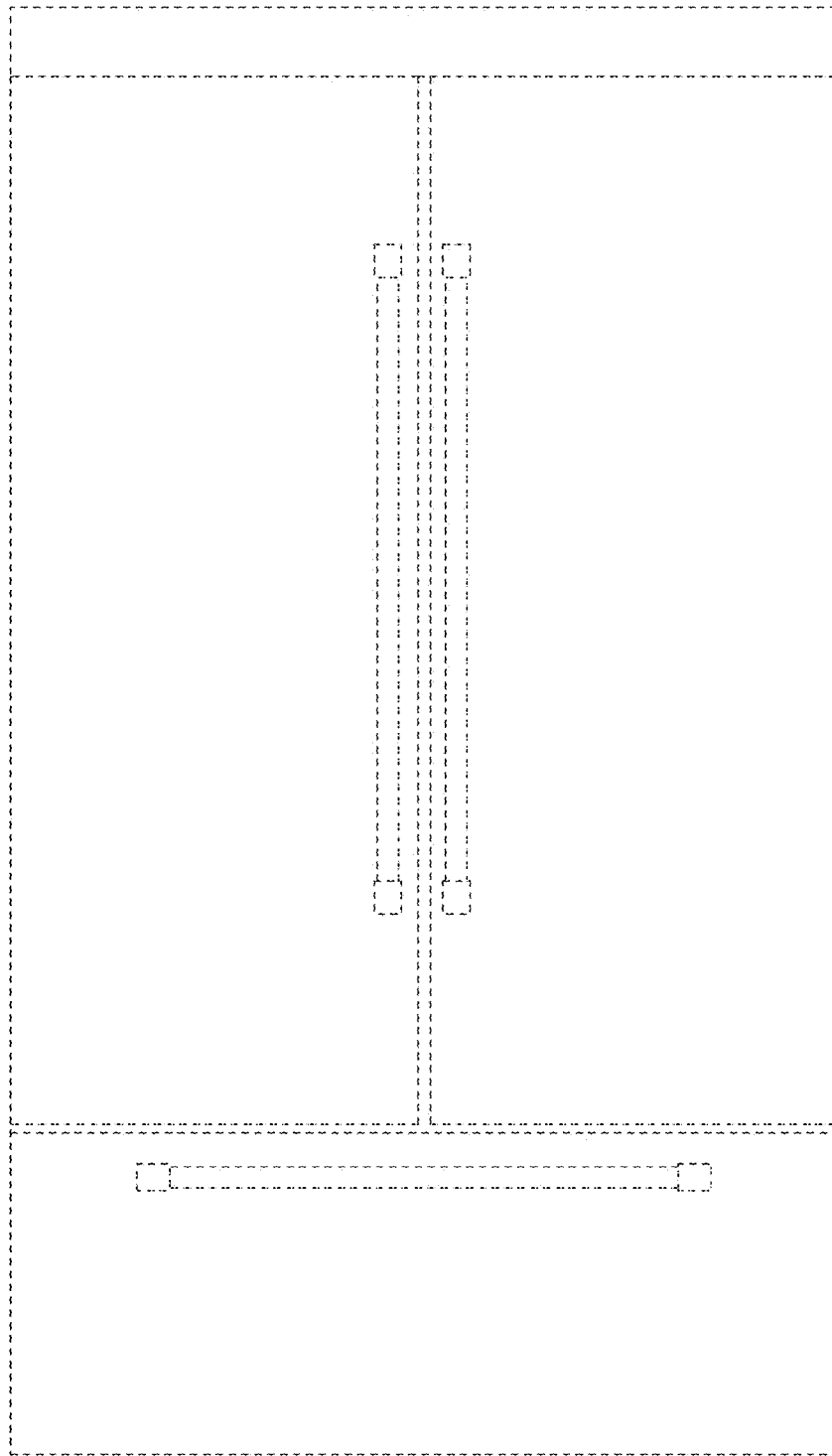

FIG. 2

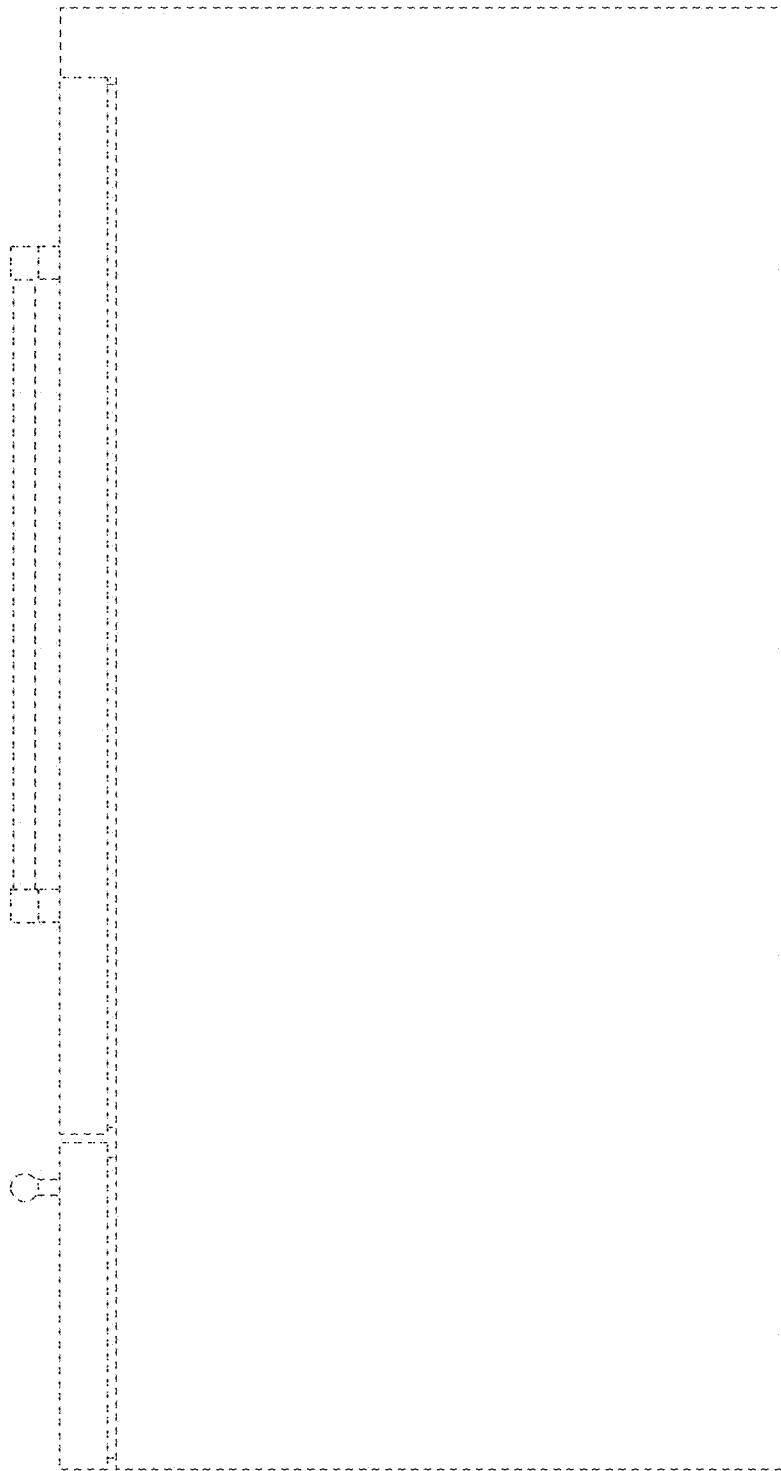

FIG. 3

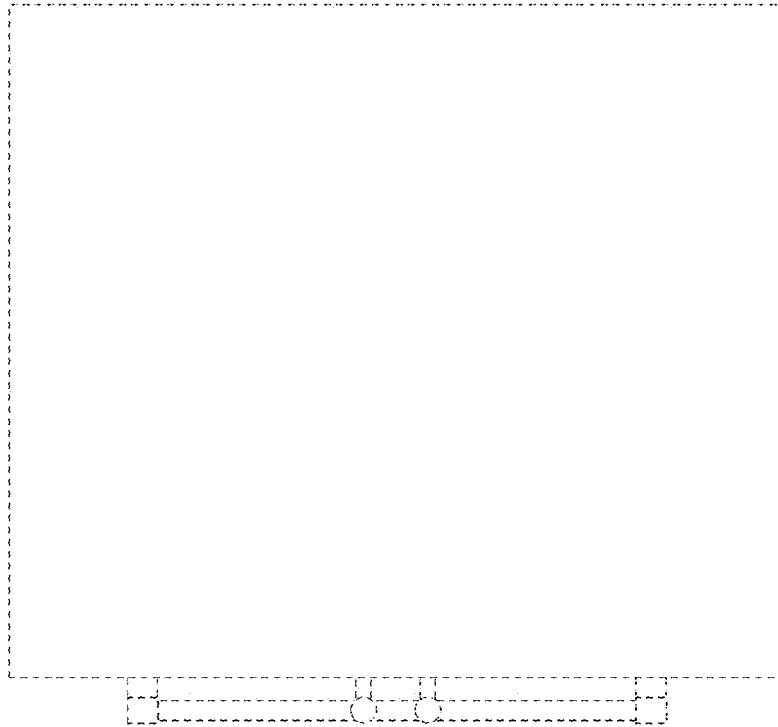

FIG. 4

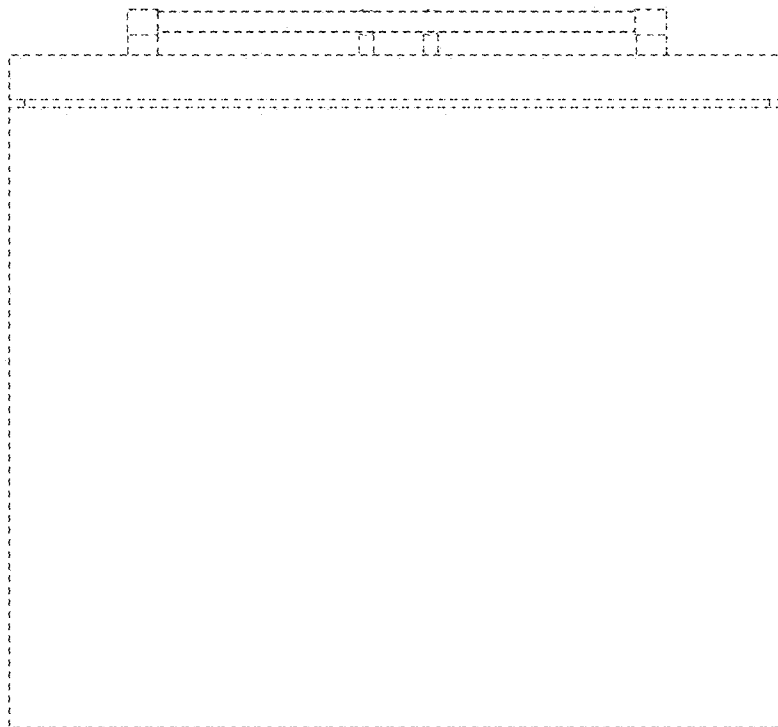

FIG. 5

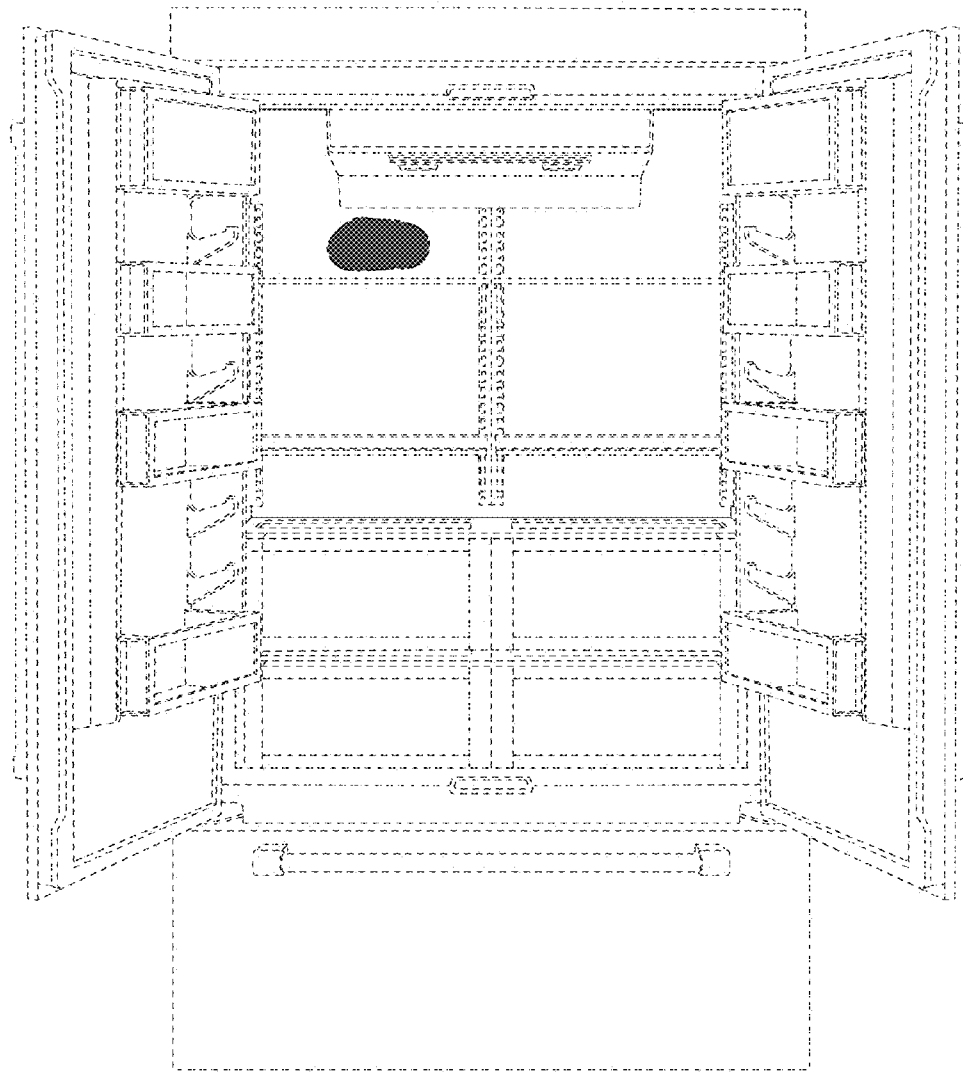

FIG. 6

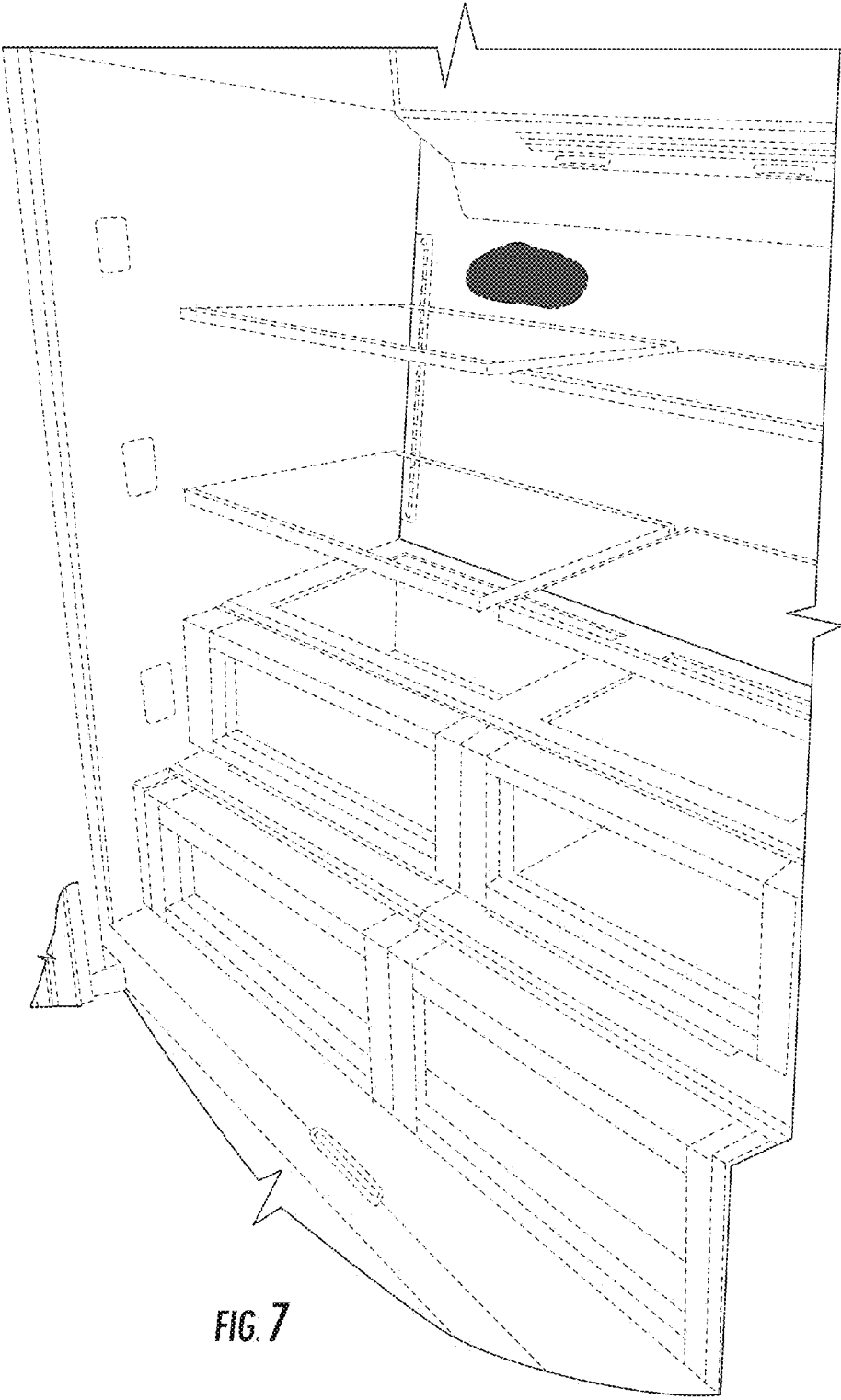
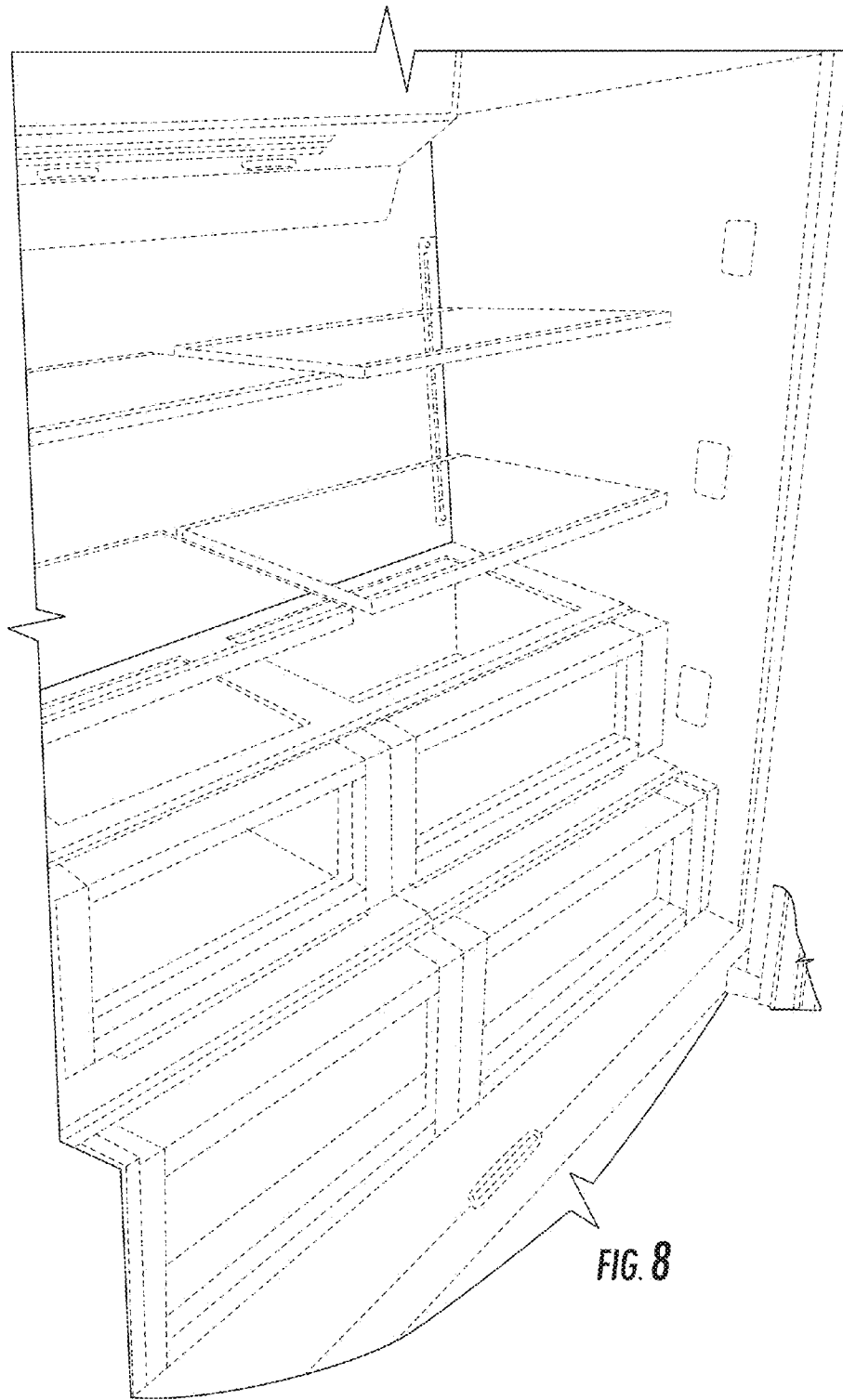

FIG. 7





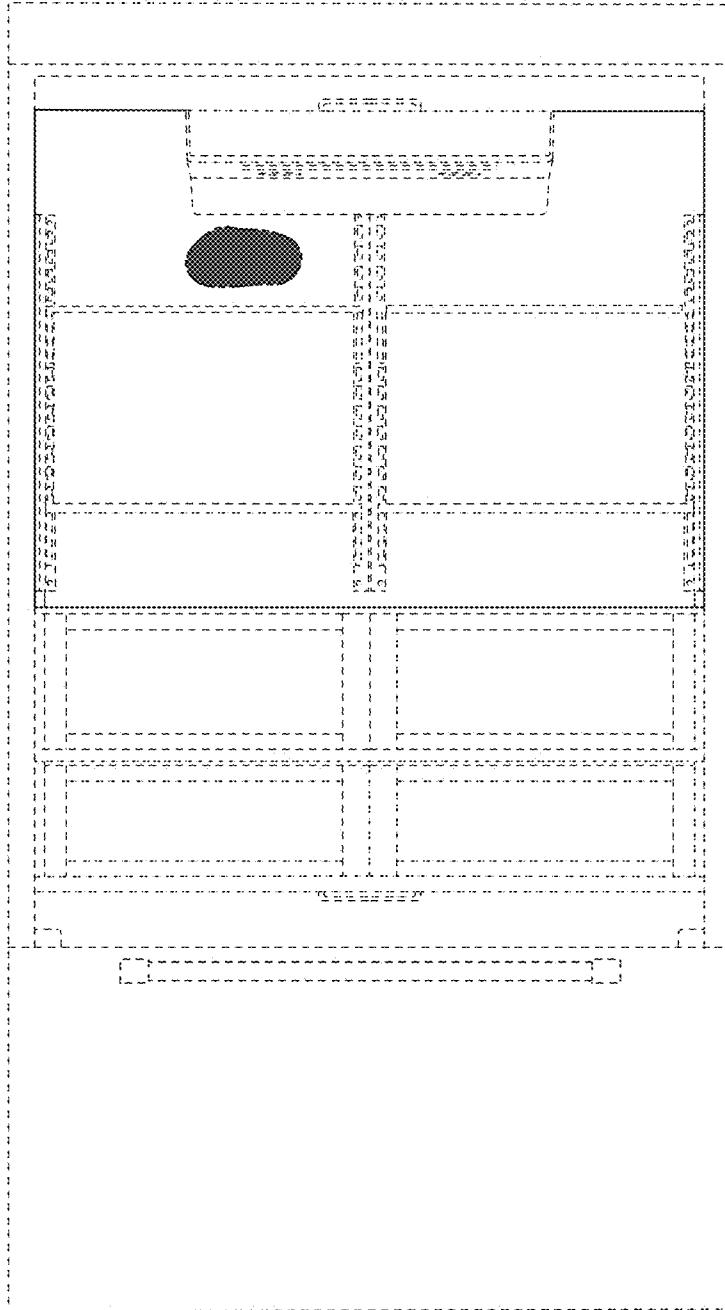

FIG. 9

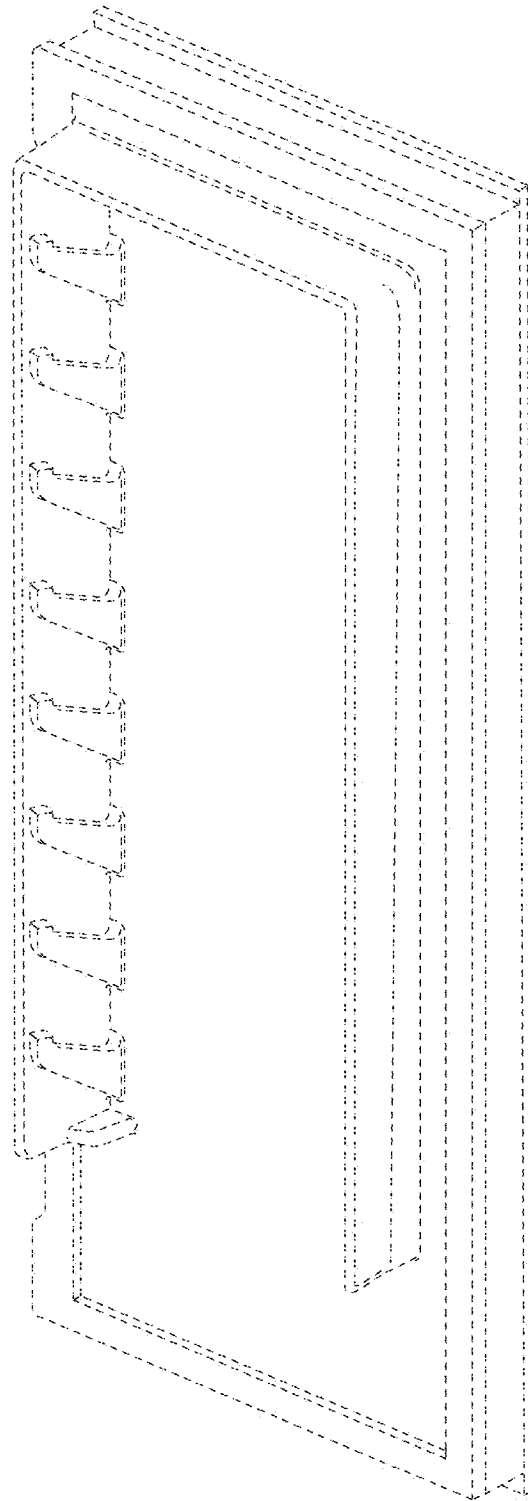
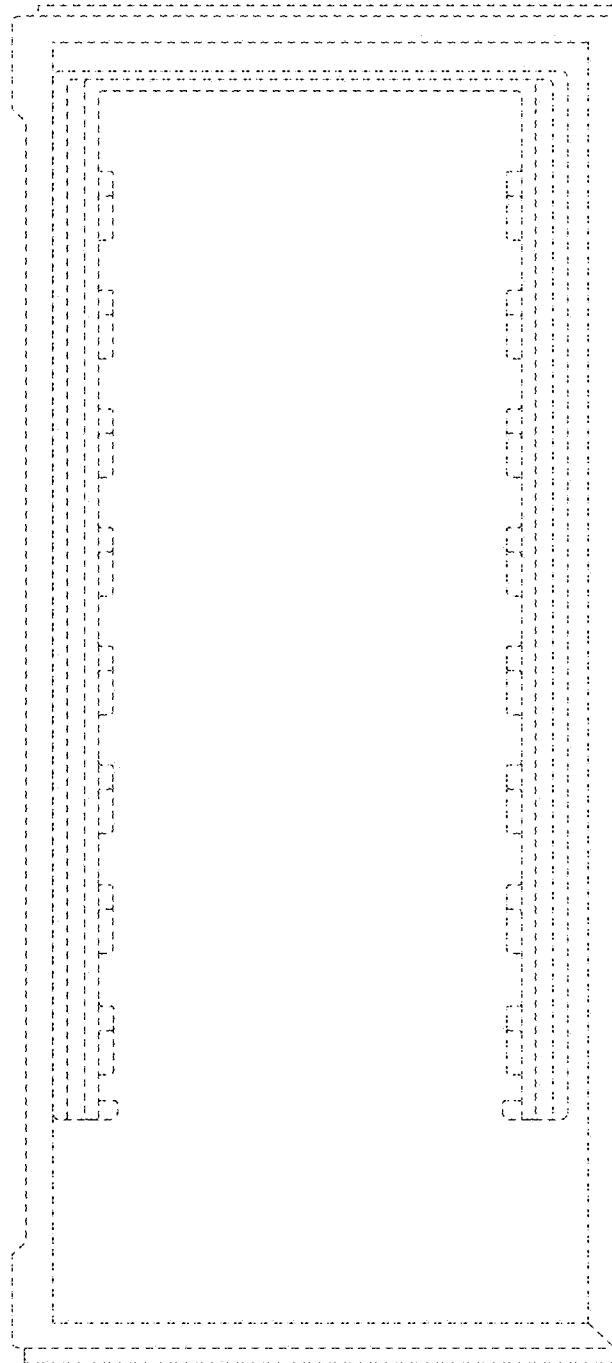

FIG. 10



**FIG. 11**

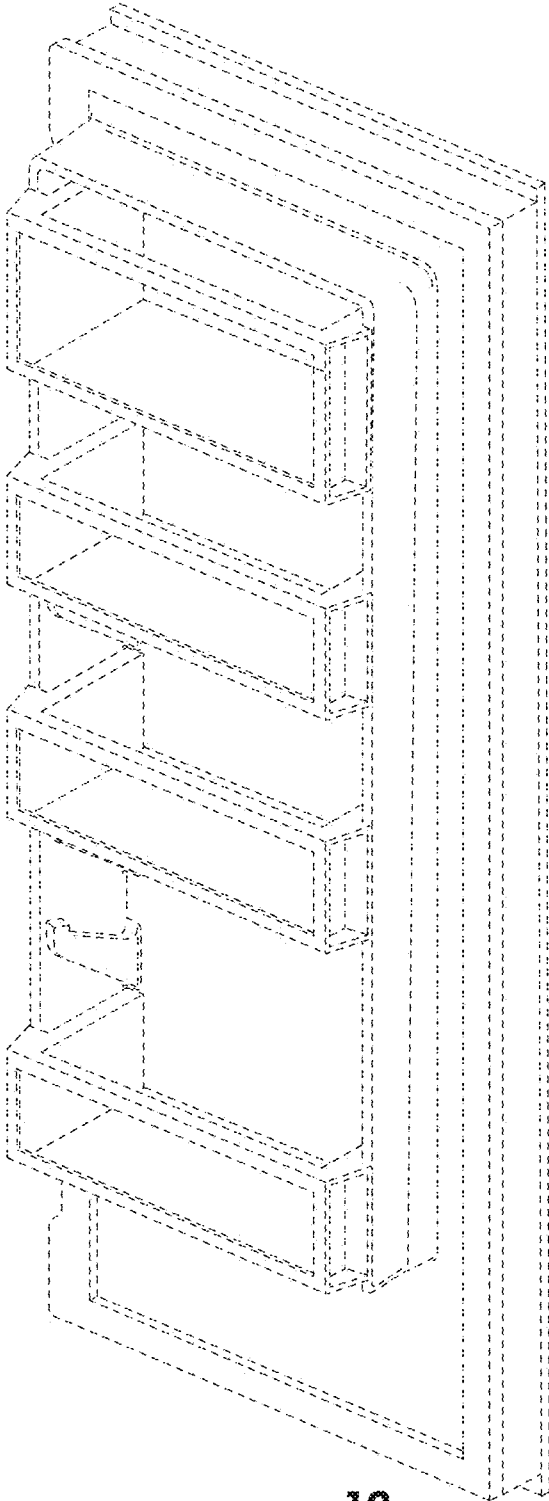

FIG. 12

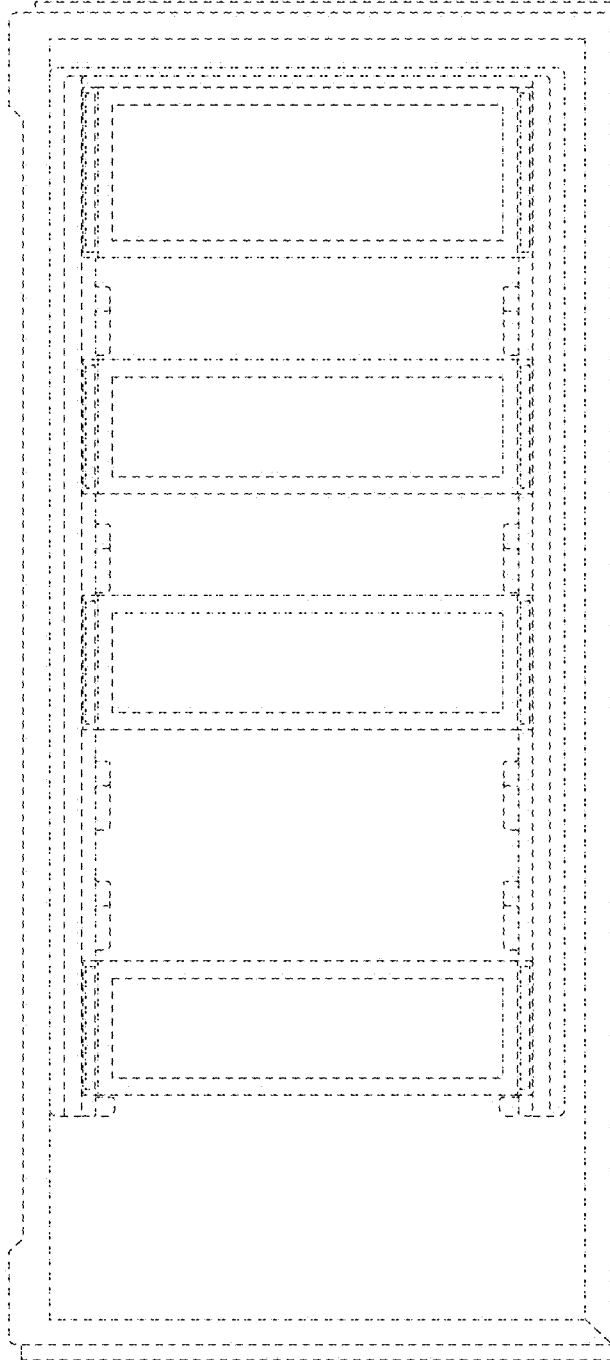

FIG. 13

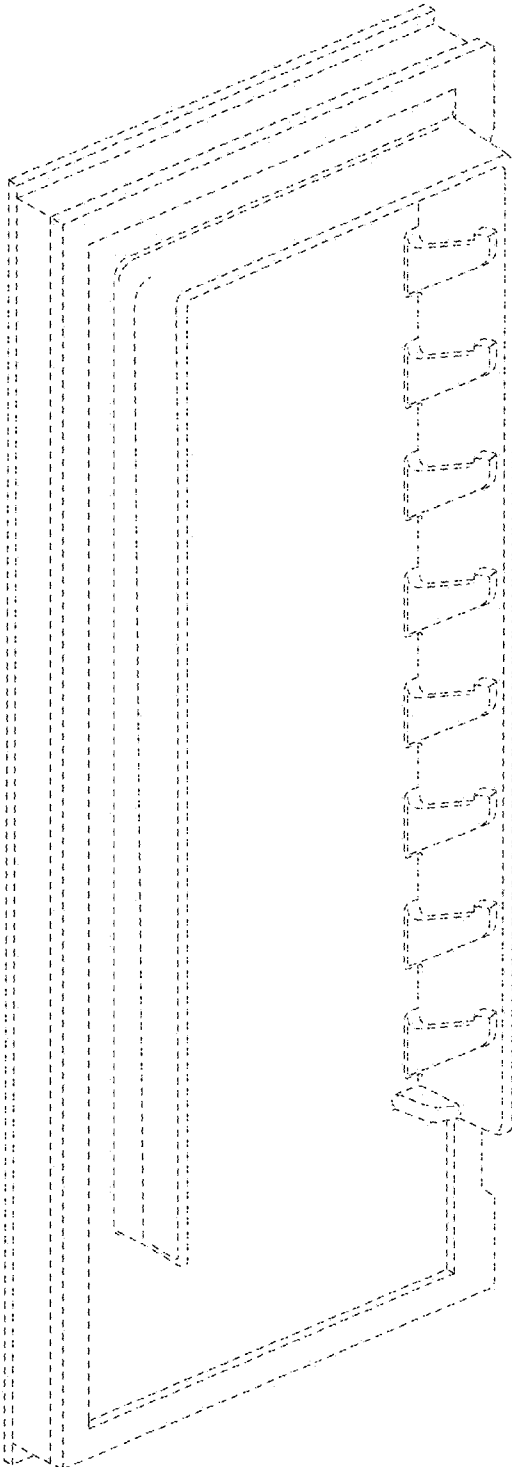

FIG. 14

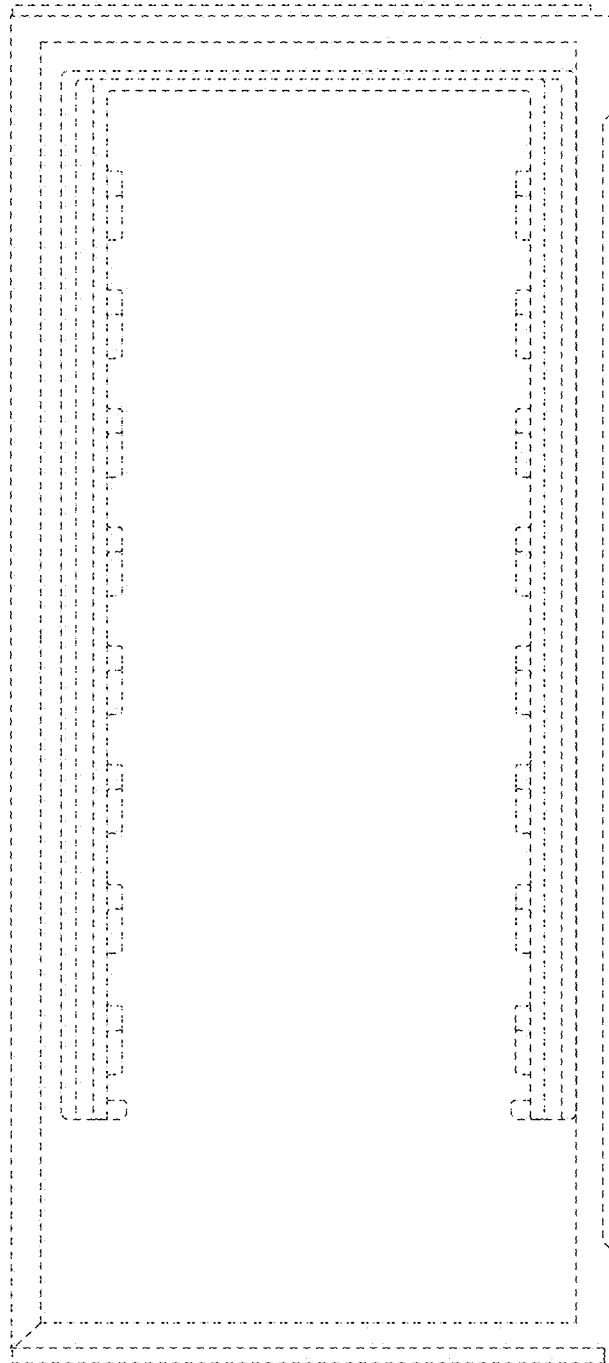

FIG. 15



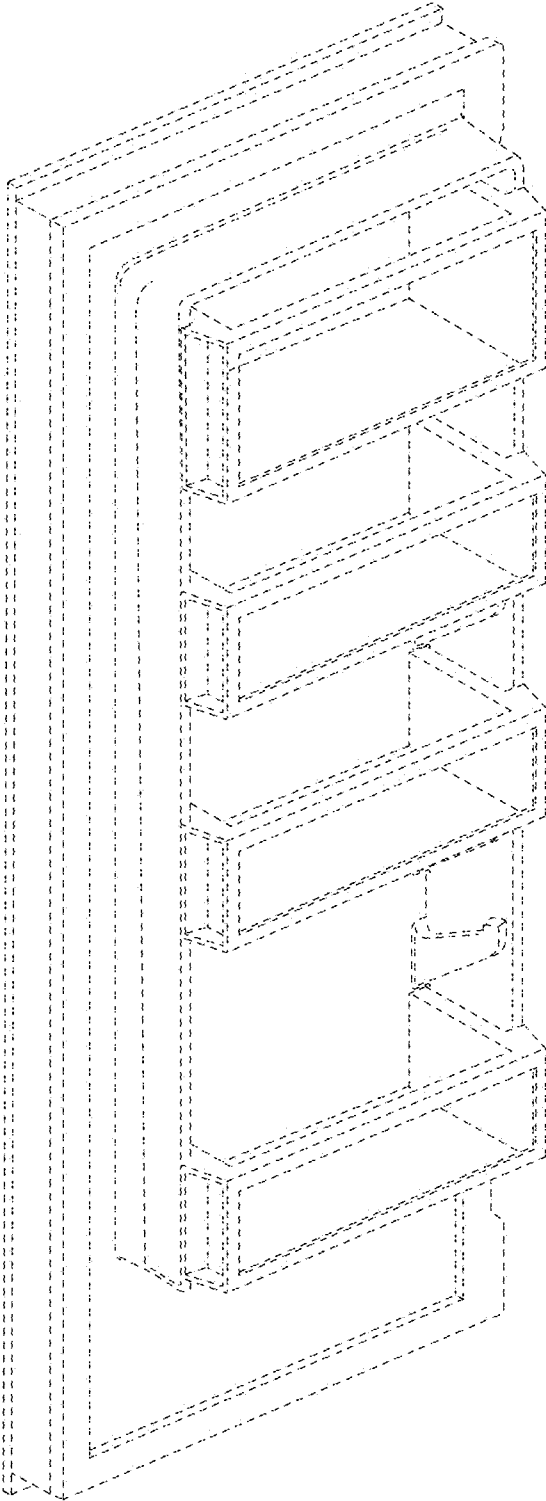

FIG. 16

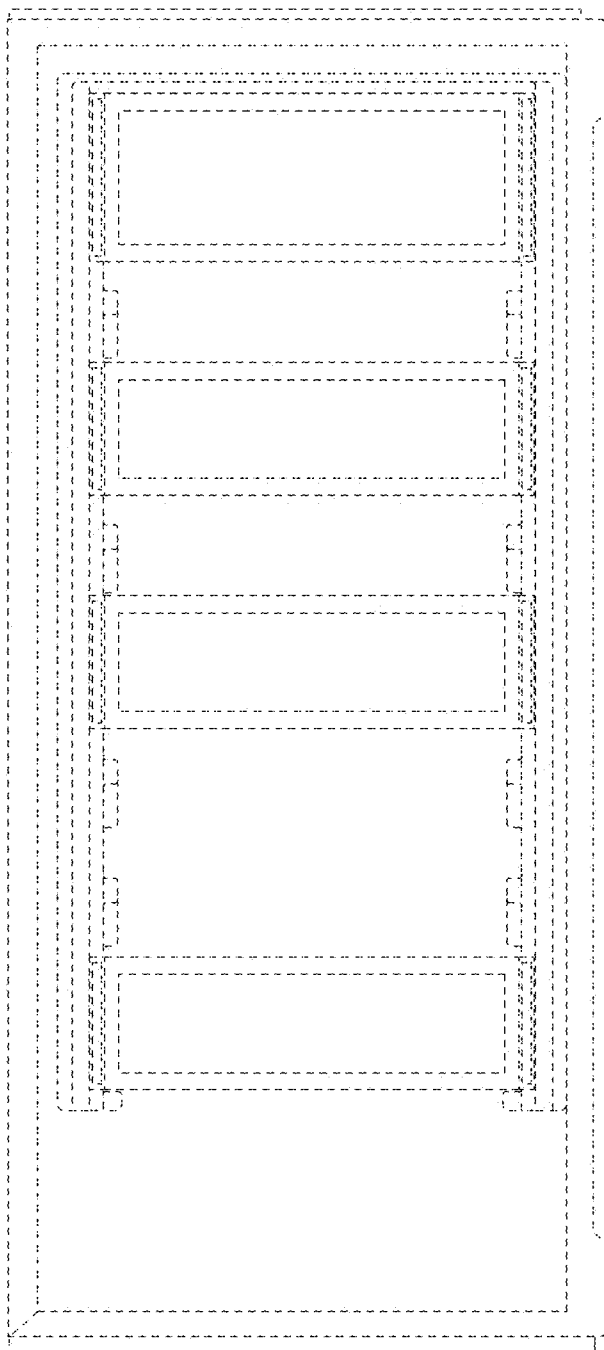

FIG. 17