



US00D763436S

(12) **United States Design Patent**
Judson et al.

(10) **Patent No.:** **US D763,436 S**

(45) **Date of Patent:** **** Aug. 9, 2016**

(54) **RESPIRATORY MASK CUSHION**

(71) Applicant: **ResMed Limited**, Bella Vista, New South Wales (AU)

(72) Inventors: **Daniel Robert Judson**, Blue Mountains (AU); **Aaron Samuel Davidson**, Sydney (AU); **Lee James Veliss**, Rotterdam (NL)

(73) Assignee: **ResMed Limited**, Bella Vista (AU)

(**) Term: **14 Years**

(21) Appl. No.: **29/483,900**

(22) Filed: **Mar. 4, 2014**

Related U.S. Application Data

(60) Continuation of application No. 29/465,542, filed on Aug. 29, 2013, now Pat. No. Des. 708,736, which is a division of application No. 29/347,611, filed on Mar. 12, 2010, now Pat. No. Des. 691,712, which is a

(Continued)

(51) **LOC (10) CI.** **29-02**

(52) **U.S. CI.**

USPC **D24/110.1**

(58) **Field of Classification Search**

USPC D24/110.1-110.4, 110.6, 127; D29/105, 107, 108, 110

CPC A62B 18/00; A62B 18/02; A62B 18/025; A62B 18/08; A62B 18/10; A62B 23/00; A62B 23/02; A62B 23/025; A62B 23/06; A41D 13/11; A61M 16/0622; A61M 16/0616; A61M 16/0816; A61M 16/08; A61M 16/0633; A61M 16/0666; A61M 2210/0618; A61M 16/0683

See application file for complete search history.

(56) **References Cited**

U.S. PATENT DOCUMENTS

D188,471 S 7/1960 Terwilliger
4,182,458 A 1/1980 Meckler

(Continued)

FOREIGN PATENT DOCUMENTS

JP 2004-000573 1/2004
JP 2009-039528 2/2009
WO 2010/131189 11/2010

OTHER PUBLICATIONS

U.S. Appl. No. 29/465,542, filed Aug. 29, 2013, Judson et al.

Primary Examiner — Barbara Fox

Assistant Examiner — Lilyana Bekic

(74) *Attorney, Agent, or Firm* — Nixon & Vanderhye P.C.

(57) **CLAIM**

The ornamental design for a respiratory mask cushion, as shown and described.

DESCRIPTION

FIG. 1 is a front perspective view showing a respiratory mask cushion according to a first embodiment of our new design; FIG. 2 is a reverse perspective view thereof;

FIG. 3 is a front view thereof;

FIG. 4 is a rear view thereof;

FIG. 5 is a top view thereof;

FIG. 6 is a bottom view thereof;

FIG. 7 is a left side view thereof;

FIG. 8 is a right side view thereof;

FIG. 9 is a front perspective view showing a respiratory mask cushion according to a second embodiment of our new design;

FIG. 10 is a reverse perspective view thereof;

FIG. 11 is a front view thereof;

FIG. 12 is a rear view thereof;

FIG. 13 is a top view thereof;

FIG. 14 is a bottom view thereof;

FIG. 15 is a left side view thereof; and,

FIG. 16 is a right side view thereof.

The broken lines in the drawings illustrate portions of the respiratory mask cushion that form no part of the claimed design.

1 Claim, 8 Drawing Sheets

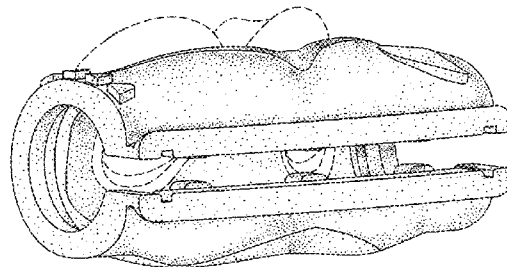
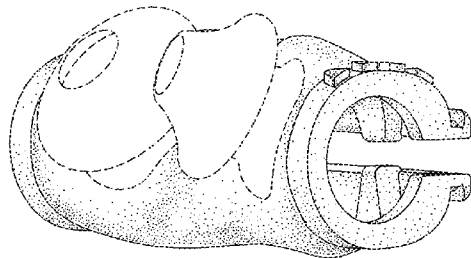

Related U.S. Application Data

continuation of application No. 29/311,161, filed on Jan. 6, 2009, now Pat. No. Des. 614,290, which is a division of application No. 29/258,084, filed on Apr. 14, 2006, now Pat. No. Des. 587,800.

(56)

References Cited

U.S. PATENT DOCUMENTS

D328,033 S	7/1992	DiGuisseppi	D589,140 S *	3/2009	Guney	D24/110.1
D375,018 S	10/1996	Goto et al.	D591,419 S *	4/2009	Chandran	D24/110.1
5,724,965 A	3/1998	Handke et al.	D596,739 S	7/2009	Ng et al.	
5,803,285 A	9/1998	Hirota	D612,933 S *	3/2010	Prentice	D24/110.1
6,532,961 B1	3/2003	Gunaratnam et al.	D614,288 S *	4/2010	Judson	D24/110.1
D480,640 S	10/2003	Oyama et al.	D614,289 S *	4/2010	Veliss	D24/110.1
D493,522 S	7/2004	Fu et al.	D614,290 S	4/2010	Judson et al.	
D501,138 S	1/2005	Uchiyama	D623,288 S	9/2010	Lubke et al.	
D515,698 S	2/2006	Lang et al.	7,942,150 B2 *	5/2011	Guney	A61M 16/06 128/207.13
D528,417 S	9/2006	Matsuda et al.	D645,557 S *	9/2011	Scheiner	D24/110.1
D542,912 S *	5/2007	Gunaratnam	D656,231 S	3/2012	Henry et al.	
D543,620 S	5/2007	Chu et al.	D659,237 S	5/2012	Lubke et al.	
D549,323 S *	8/2007	Kwok	D664,250 S	7/2012	Scheiner et al.	
D557,802 S *	12/2007	Miceli, Jr.	D691,712 S	10/2013	Judson et al.	
D562,446 S	2/2008	Chu et al.	D692,554 S	10/2013	Siew et al.	
D562,976 S *	2/2008	Guney	8,701,668 B2 *	4/2014	Selvarajan	128/207.13
D586,907 S *	2/2009	Judson	D708,736 S *	7/2014	Judson	D24/110.5
D586,911 S	2/2009	McAuley et al.	D729,381 S *	5/2015	Himes	D24/110.1
D587,800 S	3/2009	Judson et al.	9,084,863 B2 *	7/2015	Ho	A61M 16/0488
D588,258 S *	3/2009	Judson	D746,436 S *	12/2015	Guney	D24/110.1
D589,139 S *	3/2009	Guney	2005/0241644 A1 *	11/2005	Gunaratnam	A61M 16/06 128/207.18
			2009/0032026 A1	2/2009	Price et al.	
			2009/0151729 A1	6/2009	Judson et al.	
			2009/0320851 A1 *	12/2009	Selvarajan	A61M 16/0683 128/207.13
			2011/0041855 A1	2/2011	Gunaratnam et al.	
			2013/0037030 A1 *	2/2013	Matula, Jr.	A61M 16/0683 128/205.25

* cited by examiner

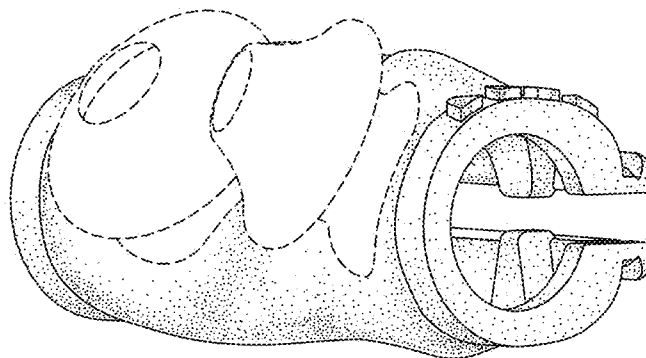

Fig. 1

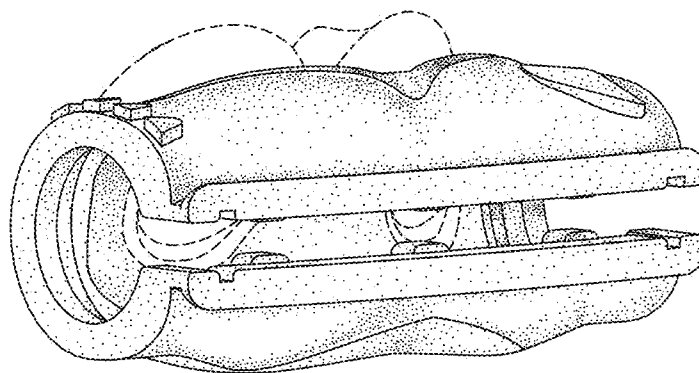

Fig. 2

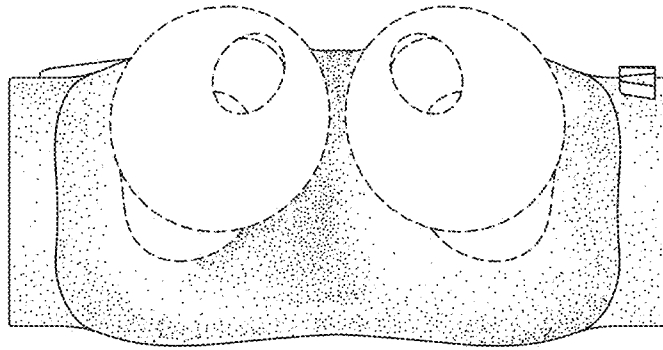

Fig. 3

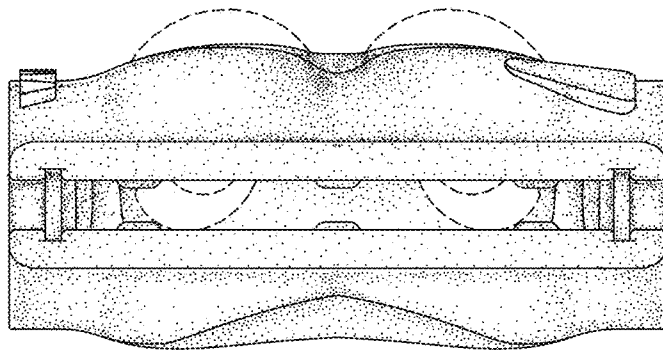

Fig. 4

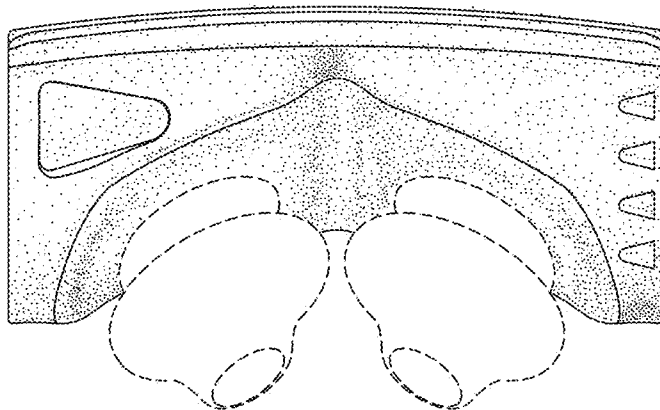

Fig. 5

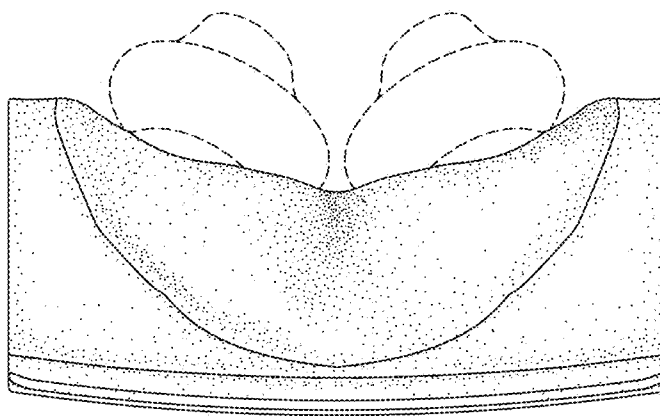

Fig. 6

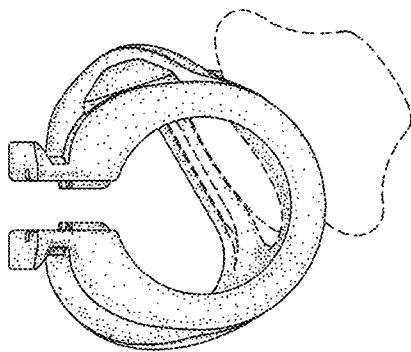

Fig. 7

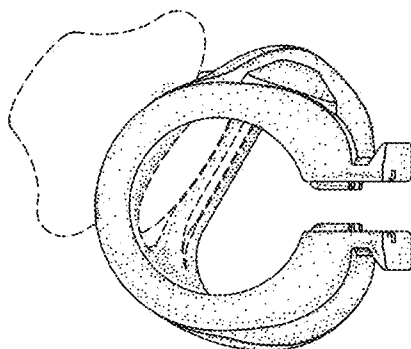

Fig. 8

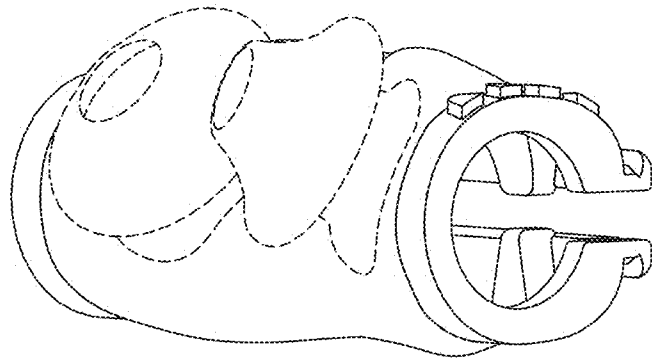

Fig. 9

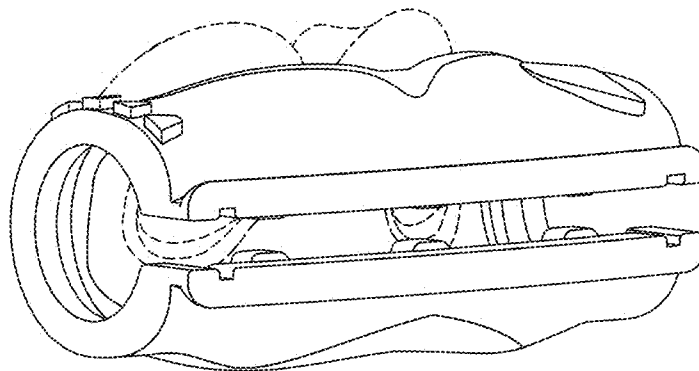

Fig. 10

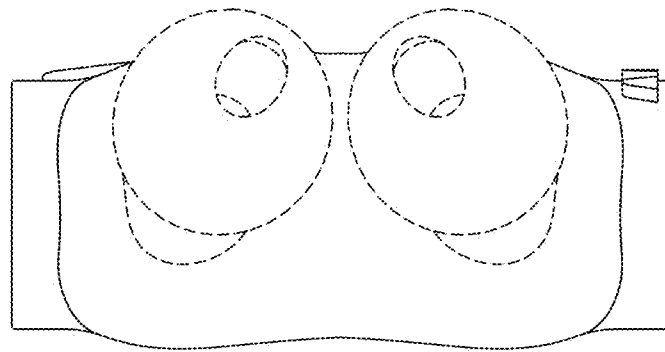

Fig. 11

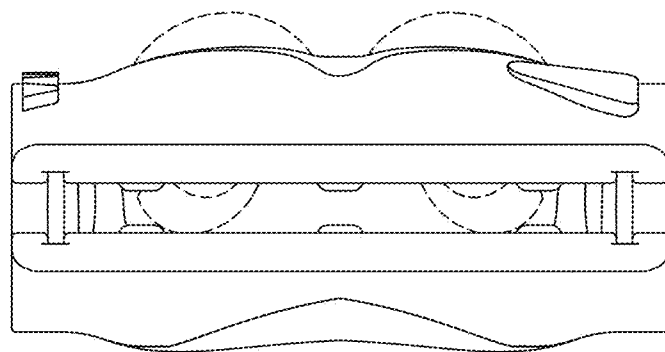

Fig. 12

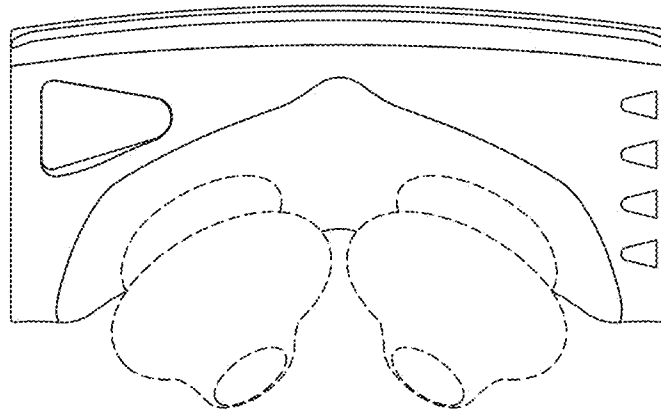

Fig. 13

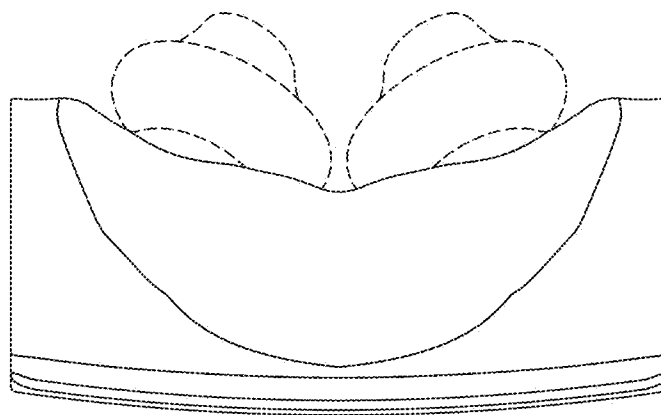

Fig. 14

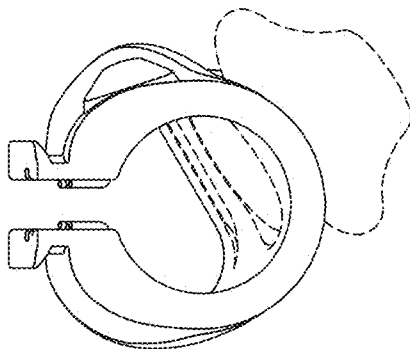

Fig. 15

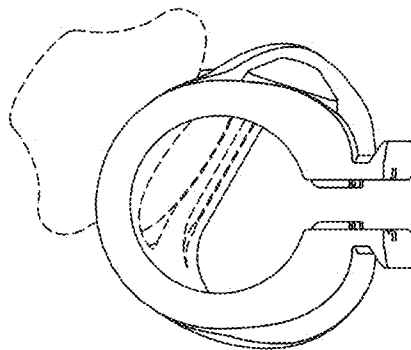

Fig. 16