

(12) INTERNATIONAL APPLICATION PUBLISHED UNDER THE PATENT COOPERATION TREATY (PCT)

(19) World Intellectual Property Organization  
International Bureau



(43) International Publication Date  
4 December 2003 (04.12.2003)

PCT

(10) International Publication Number  
**WO 03/100641 A1**

(51) International Patent Classification<sup>7</sup>: **G06F 15/16**

CA 92618 (US). **PARK, David** [US/US]; 2801 Sepulbeda Boulevard, Apt. 116, Irvine, CA 90505 (US).

(21) International Application Number: PCT/US03/16991

(22) International Filing Date: 28 May 2003 (28.05.2003)

(74) Agent: **MIZER, Susan**; Arter & Hadden LLP, 1100 Huntington Building, 925 Euclid Avenue, Cleveland, OH 44115-1475 (US).

(25) Filing Language: English

(26) Publication Language: English

(30) Priority Data:  
10/156,331 28 May 2002 (28.05.2002) US  
10/201,089 23 July 2002 (23.07.2002) US  
10/202,601 24 July 2002 (24.07.2002) US  
10/340,169 10 January 2003 (10.01.2003) US

(81) Designated States (*national*): AE, AG, AL, AM, AT, AU, AZ, BA, BB, BG, BR, BY, BZ, CA, CH, CN, CO, CR, CU, CZ, DE, DK, DM, DZ, EC, EE, ES, FI, GB, GD, GE, GH, GM, HR, HU, ID, IL, IN, IS, JP, KE, KG, KP, KR, KZ, LC, LK, LR, LS, LT, LU, LV, MA, MD, MG, MK, MN, MW, MX, MZ, NI, NO, NZ, OM, PH, PL, PT, RO, RU, SC, SD, SE, SG, SK, SL, TJ, TM, TN, TR, TT, TZ, UA, UG, UZ, VC, VN, YU, ZA, ZM, ZW.

(71) Applicants: **TOSHIBA CORPORATION** [JP/JP]; 6-78, Minami-cho, Mishima-shi, Shizuoka 411-8520 (JP).  
**TOSHIBA TEC KABUSHIKI KAISHA** [JP/JP]; 6-78, Minami-cho, Mishima-shi, Shizuoka 411-8520 (JP).

(84) Designated States (*regional*): ARIPO patent (GH, GM, KE, LS, MW, MZ, SD, SL, SZ, TZ, UG, ZM, ZW), Eurasian patent (AM, AZ, BY, KG, KZ, MD, RU, TJ, TM), European patent (AT, BE, BG, CH, CY, CZ, DE, DK, EE, ES, FI, FR, GB, GR, HU, IE, IT, LU, MC, NL, PT, SE, SI, SK, TR), OAPI patent (BF, BJ, CF, CG, CI, CM, GA, GN, GQ, GW, ML, MR, NE, SN, TD, TG).

(71) Applicants and

(72) Inventors: **WU, Vincent** [US/US]; 71 Wellington, Irvine,

[Continued on next page]

(54) Title: SYSTEM AND METHOD FOR GENERATING AND TRANSFERRING IMAGE DATA

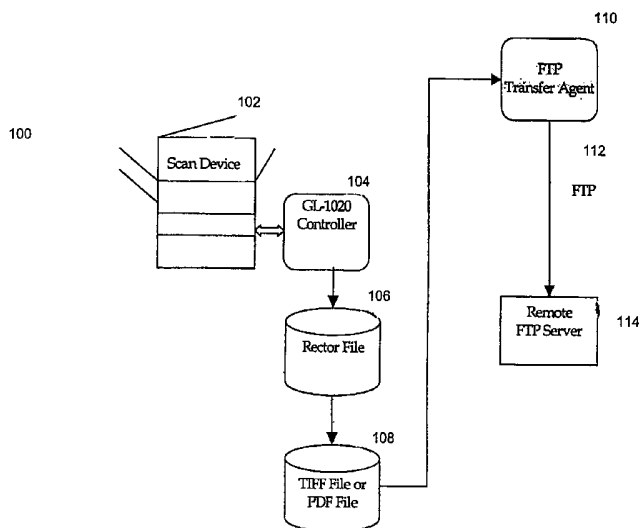

(57) Abstract: In one embodiment, this invention is directed to a system and method for transferring image data from a document reading device, such as a scanning device, to a file transfer protocol (FTP) server via FTP. In another embodiment, this invention is directed to a system and method for compressing and archiving image data received from a document reading device, such as a scanning device, and transferring the archived image data to a file transfer protocol (FTP) server via FTP. In another embodiment, this invention is directed to a system and method for receiving image data from a document reading device, selecting optical character recognition parameters, and performing optical character recognition on the image data in accordance with the parameters. In another embodiment, this invention is directed to a system and method for transferring image data from a document reading device, such as a scanning device, to a plurality of agents.



WO 03/100641 A1



**Published:**

- *with international search report*
- *before the expiration of the time limit for amending the claims and to be republished in the event of receipt of amendments*

*For two-letter codes and other abbreviations, refer to the "Guidance Notes on Codes and Abbreviations" appearing at the beginning of each regular issue of the PCT Gazette.*

## SYSTEM AND METHOD FOR GENERATING AND TRANSFERRING IMAGE DATA

### Background of the Invention

5           This invention is directed to a system and method for generating transferring  
image data. In one embodiment, this invention is directed to a system and method for  
transferring image data from a document reading device, such as a scanning device, to a  
file transfer protocol (FTP) server via FTP. In another embodiment, this invention is  
directed to a system and method for compressing and archiving image data received from  
10 a document reading device, such as a scanning device, and transferring the archived image  
data to a file transfer protocol (FTP) server via FTP. In another embodiment, this  
invention is directed to a system and method for receiving image data from a document  
reading device, selecting optical character recognition parameters, and performing optical  
character recognition on the image data in accordance with the parameters. In yet another  
15 embodiment, this invention is directed to a system and method for transferring image data  
from a document reading device, such as a scanning device, to a plurality of agents.

Typically, when a user uses a scanner, copier, or other document reading device,  
the generated image data is saved to shared network drives to be processed further. These  
shared network drives are easily accessed from a Windows environment. However, non-  
20 Windows users often have problems accessing the data in the shared network drives and  
have to go through a cumbersome process to move the data to a local workstation after the  
data is generated. For example, if a user wants to send the image data to a remote FTP  
server by FTP, the user needs to move the data to a device that has the FTP capability and  
send the data to the FTP server. Further, a user may need to install an application or  
25 spend additional time configuring his workstation or device in order to access the data.

Further, in order to perform further processing the user has to access the image  
data from the shared network drive and then go through a cumbersome process to move  
the data to a local workstation after the data is generated. For example, if a user wants to  
send the image data to an optical character recognition device, the user needs to move the  
30 data to a device that has the optical character recognition capability and send the data to  
such device. Also, if a user wants to send the image data to an optical character  
recognition device and to an electronic mail server, the user must move the data to a  
device that has the optical character recognition capability and then must also send the

data to the electronic mail server. The user must engage in these intermediate steps for each device or agent to which the user wants to send the image or have the image processed.

There is a need for a system and method which provides easier archiving and transferring of image data to a server, easier access to the image data by Window users and non-Windows users, and which increases use of the document reading device and the productivity of the user. There is also a need for a system and method for easily performing optical character recognition on image data received from a document reading device. Further, there is a need for a system and method for easily transferring image data from a document reading device to a plurality of different agents for processing.

### Summary of the Invention

In accordance with the present invention, there is provided a system and method for easily transferring image data to a server, easier access to the image data by Window users and non-Windows users, and which increases use of the document reading device and the productivity of the user.

Further, in accordance with the present invention, there is provided a system and method for easily performing optical character recognition on image data received from a document reading device.

Further, in accordance with the present invention, there is provided a system and method for easily transferring image data from a document reading device to a plurality of different agents for processing.

Still further, in accordance with the present invention, there is provided a system and for transferring image data from a document reading device to a server. The system and comprise receiving image data from an associated document reading device. The system and method also comprise selecting an associated data transfer signal, the data transfer signal including data representative of at least one selected data transfer format and a data transfer target. The system and method further comprise transmitting the image data via a data transfer system from an associated document reading device to an associated file server in accordance with the data transfer selection signal.

Still further, in accordance with the present invention, there is provided a system and method for archiving image data received from a document reading device and transferring the archived image data to a file server. The system and method comprise

receiving image data from an associated document reading device. The system and method also comprise selecting an associated data transfer signal, the data transfer signal including data representative of at least one selected data transfer format and a data transfer target. The system and method further comprise compressing and archiving the image data and means adapted for transmitting the archived image data via a data transfer system from an associated document reading device to an associated file server in accordance with the data transfer selection signal.

Still further, in accordance with the present invention, there is provided a system and method for performing optical character recognition on image data received from a document reading device. The system and method comprise receiving image data from an associated document reading device. The system and method further comprise selecting optical character recognition parameters for performing optical character recognition on the image data. The system and method also comprise performing optical character recognition on the image data and in accordance with selected optical character recognition parameters.

Still further, in accordance with the present invention, there is provided a system and method for transferring image data from a document reading device to a plurality of agents. The system and method comprise receiving image data from an associated document reading device. The system and method also comprise selecting an associated data transfer signal for each associated agent, wherein each data transfer signal includes data representative of a selected data transfer format and wherein the selected data transfer format is the same for each agent. The system and method further comprise transmitting the image data via a data transfer system from an associated document reading device to each associated agent in accordance with the data transfer selection signal for each agent, wherein the image data is transmitted sequentially from the document reading device to each agent.

Advantages of the system and method of the present invention, include, but are not limited to, the ability to easily transfer image data between a document reading device and a file server, the ability for Windows users and non-Windows users to easily access the image data, an increase in the usage of the document reading device and the productivity of the user, and ability to backup all image data stored on shared network drives, the ability to easily convert image data to other application formats, the ability to easily transfer image data between a document reading device and a plurality of agents, and the

ability for multiple processing of image data.

These and other advantages, aspects, and features will be understood by one of ordinary skill in the art upon reading and understanding the specification.

5

### **Brief Description of the Drawings**

Figure 1 is a block diagram illustrating the preferred embodiment of the system according to the present invention.

Figures 2a and 2b show a sample summary template for the desired settings for the document reading device and the desired data transfer signal.

10 Figures 3a, 3b, and 3c show sample templates for selecting the desired settings for the document reading device.

Figure 4 shows a sample template for selecting the desired data transfer signal for transmitting the generated image data to the file server.

Figure 5 is a sample screen that shows the status of the transfer of the image data.

15 Figure 6 is a block diagram illustrating the preferred embodiment of the system according to the present invention.

Figure 7 shows a sample template for selecting the desired data transfer signal for transmitting the generated image data to the file server.

Figure 8 is a sample screen that shows the status of the transfer of the image data.

20 Figure 9 is a block diagram illustrating the preferred embodiment of the system according to the present invention.

Figure 10 shows a sample template for selecting the desired optical character recognition parameters for transmitting the generated image data to the file server.

25 Figure 11 is a block diagram illustrating the preferred embodiment of the system according to the present invention.

Figure 12 shows a sample template for selecting the desired settings for the document reading device.

Figure 13 shows a sample template for enabling the system to transmit the image data to a plurality of multiple agents.

30 Figure 14 shows a sample template for associating agents with a user's mailbox.

Figure 15 shows a sample template for selecting the desired data transfer signal for transmitting the generated image data to an FTP server.

Figure 16 shows a sample template for selecting the desired data transfer signal for

transmitting the generated image data to a TWAIN agent.

Figure 17 shows a sample template for selecting the desired data transfer signal for transmitting the generated image data to a file.

Figure 18 shows a sample template for selecting the desired data transfer signal for transmitting the generated image data to an electronic mail address.

Figure 19 shows a sample template for selecting the desired data transfer signal for transmitting the generated image data to a facsimile device.

Figure 20 shows a sample template for selecting the desired data transfer signal for transmitting the generated image data to a folder.

10

### **Detailed Description of the Preferred Embodiment**

In one embodiment, the present invention is directed to a system and method for transferring image data from a document reading device to a server. Figure 1 shows a block diagram preferred embodiment of the system according to the present invention generally designated as 100. The system comprises a document reading device 102, such as a scanner or copier, for generating image data. The document reading device is any suitable document reading device known in the art. Preferably, the document reading device is a scanning device, a copying device, and an optical character recognition device. More preferably, the document reading device is a scanning device. Suitable commercially available document reading devices include, but are not limited to, the Toshiba e-Studio Series Controller. The document reading device further comprises a controller 104 which controls the functions of the document reading device and includes storage means for storing the image data.

In operation, the user inputs the document or other data into the document reading device to generate the image data and selects the desired settings for generating the image data. The image data is stored as a rector file 106 on the controller or any other suitable memory device. The image data is then converted by the controller to an appropriate format, such as TIFF or PDF, as shown by 108. A Transfer Agent 110 is used to access the image data on the controller. An data transfer session is initiated on the communication link 112 to the remote file server 114 whereupon the image data is transferred to the remote file server via a data transfer system. The communication link is comprised of one or more segments of wired or wireless communications. Suitable communications link include, but are not limited to, FTPLIB-3.1. In a preferred

30

embodiment, the file server is an FTP server and the data transfer system is FTP.

Preferably, the data transfer is completed on a system operating under Linux or Unix.

The controller 104 includes means adapted for selecting the desired settings for generating the image data and means adapted for selecting a desired data transfer signal for transferring the generated image data to the server. Figures 2a and 2b show a preferred sample summary template for the desired settings for the document image device and the desired transfer signal. Figure 2a shows the top half of summary screen 200. The screen shows the document scanning method 202, the document type 204, the exposure 206, and the paper size 208 chosen. The screen also shows the IP address and port of the server to which the image data is to be transferred 210, the username 212, and the password 214 of the user. The user selects the Cancel button 216 to cancel the settings or the Scan button 218 to initiate the process. The user can also select the Settings button 220 to change the scanning parameters as shown in Figures 3a, 3b, and 3c.

Figure 2b shows the bottom half of summary screen 200. The screen shows the selected the desired file format as selected from single page TIFF 222, multi-page TIFF 224, and multi-page PDF 226. The screen also shows the selected the folder in which the image data is to be stored 228 and the document name for the image data 230.

Preferred sample screen displays for selecting the desired settings for generating the image data is shown in Figures 3a, 3b, and 3c. Figure 3a shows scanning parameter setting screen 1 shown as 300. The user selects if the document is to be scanned using a single page method 302, book method 304, or tablet method 306. The user next specifies the rotation from the four choices shown as 308, 310, 312, and 314. The user can cancel the settings by selecting the Cancel button 316. The user can go to scanning parameter screen 2 by selecting the Next button 318. The user can also proceed to selecting the appropriate agent and associated data transfer signal by selecting the OK button 320.

Figure 3b shows scanning parameter screen 2 as 330. The user first selects the document type as either text 332, text/photo 334, and photo 336. The user then selects the resolution for the image data from 600 dots per inch (dpi) 338, 400 dpi 340, 300 dpi 342, 200 dpi 344, and 150 dpi 346. The user then selects the exposure mode from Auto 348 or manual 350. The user can cancel the settings by selecting the Cancel button 352. The user can go back to scanning parameter screen 1 by selecting the Prev button 354. The user can go to scanning parameter screen 3 by selecting the Next button 356. The user can also

proceed to selecting the appropriate agent and associated data transfer signal by selecting the OK button 358.

Figure 3c shows scanning parameter screen 3 as 360. The user can select Auto 362 for auto paper size detection mode. The user can also select Mixed Original Sizes 364 for the mixed original sizes mode. The user can also select the original paper size from the choices shown in region 366. The user can cancel the settings by selecting the Cancel button 368. The user can go back to scanning parameter screen 2 by selecting the Prev button 370. The user can also proceed to selecting the appropriate agent and associated data transfer signal by selecting the OK button 372.

A preferred sample screen display 400 for selecting the desired agent and associated data transfer signal is shown in Figure 4. The user first selects whether an e-mail should be sent to the user when an error occurs 402 and/or whether an e-mail should be sent to the user when the job is completed 404. The user then enters the e-mail address to which to send the notifications 406. The user then selects the desired agent to which the image data should be sent as shown at 408. The user then specifies the server settings by selecting the file server 410 and the file server port 412 to which the image data is to be transferred. The user then inputs his username 414 and password on the file server account 416. The user then selects the transfer settings by selecting the option to retry when the transfer fails 418. If the user selects to retry should the transfer fail, the user then inputs the retry count 420 and the retry interval 422. The user then provides the destination parameters by specifying the file path 424 and the file name 426 for the image data. The user next selects the particular file format in which the image data is to be transferred which is shown as 428. The image data format is preferably selected from PDF, single page TIFF, and multi-page TIFF. The user can also select whether to overwrite an existing file of the same name by checking the box shown as 430. The user can then select the OK button 432 to save the settings or the Cancel button 434 to cancel the settings entered.

Upon selecting the OK button, the controller 104 begins the process of transferring the image data to the file server. In one embodiment, the status of the job is provided by a sample status screen as shown in Figure 5 as 500. The job log is shown as 502 and the status of a particular job is shown as 504. Electronic mail notifications as to the status and any errors are also sent to the user as described above.

In another embodiment, the present invention is directed to a system and method for transferring image data from a document reading device to a file server. Figure 6 shows a block diagram preferred embodiment of the system according to the present invention generally designated as 600. The system comprises a document reading device 5 602, such as a scanner or copier, for generating image data. The document reading device is any suitable document reading device known in the art. Preferably, the document reading device is a scanning device, a copying device, and an optical character recognition device. More preferably, the document reading device is a scanning device. Suitable commercially available document reading devices include, but are not limited to, Toshiba 10 e-Studio Series controller.

The document reading device further comprises a controller 604 which controls the functions of the document reading device and includes storage means for storing the image data. The controller has two storage units which are labeled in Figure 6 as GL-Share 606 and GL-Twain 608.

15 In operation, the user inputs the document or other data into the document reading device to generate the image data. An Archive Utility 610 is used to access the image data on the controller. A data transfer session is initiated on the communication link 612 to the remote file server 614 whereupon the image data is transferred to the remote file server via a data transfer system. The communication link is comprised of one or more 20 segments of wired or wireless communications. Suitable communications link include, but are not limited to, FTPLIB-3.1. In a preferred embodiment, the file server is an FTP server and the data transfer system is FTP. Preferably, the data transfer is completed on an system operating under Linux or Unix.

A preferred sample screen display 700 for selecting the desired agent and 25 associated data transfer signal is shown in Figure 7. The user first selects whether the data to be compressed, archived, and transferred is GL-Share data shown as 702, GL-Twain data shown as 704, or both. Typically there are two types of image data stored on the controller, which are Twain (GL-Twain) and Share (GL-Share) image data. The user can specify the preference of data that needs to be transferred to the server.

30 The user then specifies the file server 706 and the file server port 708 to which the image data is to be transferred. The user then inputs his user identification on the server account 710, password on the server account 712. The user next inputs the file name 714 and the file path 716 for the compressed file which is to be stored on the server.

Additionally, a checkbox 718 enables the user to automatically overwrite an existing file on the server having the same file name.

There are three pushbuttons 720, 722, and 724 shown in Figure 7 which are for initiating an action. Selecting the Archive button 720 causes the current settings to be saved and initiates the process of saving the image data onto the server. Selecting the Set  
5 button 722 causes the currently displayed settings to be saved in the controller. Selecting the Reset 724 button causes any new displayed settings to be erased and the old settings to be displayed.

Upon selecting the Archive button, the controller 604 begins the process of  
10 transferring the image data to the file server. In one embodiment, the status of the job is provided by a sample status screen as shown in Figure 8 as 800. The job log is shown as 802 and the status of a particular job is shown as 804.

In another embodiment, the present invention is directed to a system and method for performing optical character recognition on image data received from a document  
15 reading device. Figure 9 shows a block diagram preferred embodiment of the system according to the present invention generally designated as 900. The system comprises a document reading device 902, such as a scanner or copier, for generating image data. The document reading device is any suitable document reading device known in the art. Preferably, the document reading device is a scanning device, a copying device, and  
20 similar device. More preferably, the document reading device is a scanning device. Suitable commercially available document reading devices include, but are not limited to, Toshiba e-Studio Series Controller. The document reading device further comprises a controller 904 which controls the functions of the document reading device and includes storage means for storing the image data.

In operation, the user inputs the document or other data into the document reading  
25 device to generate the image data and selects the desired settings for generating the image data. The image data is stored as a vector file 906 on the controller or any other suitable memory device. The image data is then converted by the controller to an appropriate format, such as TIFF, as shown by 908. An OCR Transfer Agent 910 within the  
30 controller is used to access the image data on the controller. The OCR Transfer Agent performs optical character recognition on the image data using a optical character recognition application or device to generate an optical character recognition converted document 912. Suitable optical character recognition applications or devices, include, but

are not limited to, Clara OCR. In a preferred embodiment, depending on parameters selected by the user, the image data is converted to a selected format. The document generated by the optical character recognition device is stored at a specified location within the controller.

5 Preferred sample screen displays for selecting the desired settings for generating the image data is shown in Figures 3a, 3b, and 3c. Figure 3a shows scanning parameter setting screen 1 shown as 300. The user selects if the document is to be scanned using a single page method 302, book method 304, or tablet method 306. The user next specifies the rotation from the four choices shown as 308, 310, 312, and 314. The user can cancel  
10 the settings by selecting the Cancel button 316. The user can go to scanning parameter screen 2 by selecting the Next button 318. The user can also proceed to selecting the appropriate agent and associated data transfer signal by selecting the OK button 320.

Figure 3b shows scanning parameter screen 2 as 330. The user first selects the document type as either text 332, text/photo 334, and photo 336. The user then selects the  
15 resolution for the image data from 600 dots per inch (dpi) 338, 400 dpi 340, 300 dpi 342, 200 dpi 344, and 150 dpi 346. The user then selects the exposure mode from Auto 348 or manual 350. The user can cancel the settings by selecting the Cancel button 352. The user can go back to scanning parameter screen 1 by selecting the Prev button 354. The user can go to scanning parameter screen 3 by selecting the Next button 356. The user can also  
20 proceed to selecting the appropriate agent and associated data transfer signal by selecting the OK button 358.

Figure 3c shows scanning parameter screen 3 as 360. The user can select Auto 362 for auto paper size detection mode. The user can also select Mixed Original Sizes 364 for the mixed original sizes mode. The user can also select the original paper size  
25 from the choices shown in region 366. The user can cancel the settings by selecting the Cancel button 368. The user can go back to scanning parameter screen 2 by selecting the Prev button 370. The user can also proceed to selecting the appropriate agent and associated data transfer signal by selecting the OK button 372.

A preferred sample screen display 1000 for selecting the desired optical character  
30 recognition parameters is shown in Figure 10. The user first selects the particular document type in which the image data is to be transferred which is shown as 1002. The user then inputs the resolution as OCR as shown in 1004, the scan mode as shown in 1006, and the brightness as shown in 1008. The parameters selected for generating the

image data as discussed above are shown in region 1010. If the user desires to change the scanning parameters, the user selects the Setting button 1012. If the user can cancel the optical character recognition parameters by selecting the Cancel button 1014. The user can start the scanning process by selecting Scan button 1016 or 1018. The user can save this information by selecting the Update button 1014.

Upon selecting the Scan button, either in the scanning parameters screens or the optical character recognition parameters screen, the controller 904 begins the process of generating the image data. The data is then converted to a TIFF image and the Scan to OCR Transfer Agent performs optical character recognition on the image data. The resulting document is saved on the controller.

In another embodiment, the present invention is directed to a system and method for transferring image data from a document reading device to a plurality of agents. Figure 11 shows a block diagram preferred embodiment of the system according to the present invention generally designated as 1100. The system comprises a document reading device 1102, such as a scanner or copier, for generating image data. The document reading device is any suitable document reading device known in the art. Preferably, the document reading device is a scanning device, a copying device, and a facsimile device. More preferably, the document reading device is a scanning device or a facsimile device. Suitable commercially available document reading devices include, but are not limited to, the Toshiba e-Studio Series Controller. The document reading device further comprises a controller 1104 which controls the functions of the document reading device and includes storage means for storing the image data.

In operation, the user inputs the document or other data into the document reading device to generate the image data and selects the desired settings for generating the image data. The image data is stored as a vector file 1106 on the controller or any other suitable memory device. The image data is then converted by the controller to an appropriate format, such as TIFF or PDF, as shown by 1108. The same format is used for each agent. A Transfer Agent is used to access the image data on the controller. A data transfer session is initiated on the communication link 1110 whereupon the image data is transferred sequentially to the each agent via a data transfer system. The communication link is comprised of one or more segments of wired or wireless communications.

In a preferred embodiment, there is a Transfer Agent for each agent as shown by 1112, 1114, 1116, and 1118 in Figure 11. In one embodiment, the image data is sent from

the document reading device to each agent in the order determined by the document reading device. In another embodiment, the image data is sent from the document reading device to the each agent in the order determined by the preceding transfer agent. As shown in Figure 11, the image data is sent from the document reading device to a first Transfer Agent 1112 in accordance with the data transfer signal. The image is then sent from the first Transfer Agent to a second Transfer Agent 1114 in accordance with the data transfer signal.

In a preferred embodiment, the document reading device controller includes at least one data storage area or mailbox. In this embodiment, the image data is received into the at least one data storage area and is transmitted to the plurality of agents from the at least one data storage area. In a more preferred embodiment, the at least one data storage area is associated with at least one system user. The user selects the data storage area to receive image data. The user identifies the appropriate data storage area by providing selected information about the data storage area in any manner known in the art. Such information includes, but is not limited to, data storage area location, data storage area name, access permission, user name associated with the data storage area, and user name password. The information provided by the user is then verified, and if so, the user is allowed to access the data storage area to receive the image data and transfer the image data to the plurality of agents.

The controller 1104 includes means adapted for selecting the desired settings for generating the image data and means adapted for selecting a desired data transfer signal for each agent for transferring the image.

Figure 12 shows a preferred sample screen display 1200 for selecting the desired settings for generating the image data. The user selects whether it is a double-sided scan image at 1202. The user then specifies the rotation at 1204, the document type at 1206, the resolution at 1208, the exposure at 1210, and the size of the original at 1212. The user can then select the OK button 1214 to save the settings or the Cancel button 1216 to cancel the settings entered.

Figure 13 shows a preferred sample screen display 1300 for enabling the system to transmit the image data to a plurality of agents. The region specified at 1302 shows the various agents which may be receive image data from the document reading device. To enable the system to transmit the image data to a plurality of agents, the user selects that option at 1304. Once this option is enabled, the system will only transmit the image data

to the plurality of agents selected in a single file format. Preferably, the image data is transmitted to the plurality of agents selected in Multiple Page TIFF format. Once the user has selected this option, the user can then select the OK button 1306 to save the setting or the Cancel button 1308 to cancel the settings entered.

5           Figure 14 shows a preferred sample screen display 1400 for setting up a mailbox on the document reading device controller to receive image data and to associate agents with the mailbox to receive image data from the mailbox. The associated agents include any suitable agents to which data may be transmitted from the document reading device. Suitable agents include, but are not limited to, storage repositories, servers, image  
10           generating devices, and optical character recognition systems. The screen provides information about the mailbox, such as the mailbox number 1402, whether the mailbox is password protected 1404, whether the user desires electronic mail notification as to the status of the transfer 1406, and information about the associated agents 1408, 1410, 1412. The user may edit the mailbox properties by selecting the Edit button 1414. The user then  
15           is allowed to edit the various properties associated with the mailbox. The user may change the password associated with the mailbox by selecting the Change Password button 1416. The user is then prompted to change the password. The user may delete the mailbox by selecting the Delete button 1418. The mailbox is then deleted from the document reading device controller.

20           The user may add agents to be associated with the mailbox by selecting the Add Agent button 1420. The user is then prompted as to which agent it wants to add and directed to the appropriate template for selecting the desired data transfer signal for transmitting the image data to such agent. The user may delete an agent by selecting the Delete Agent button 1422 and then selecting the agent or agents to be deleted. The user  
25           may edit the desired data transfer signal for an agent by selecting the Edit Agent button 1424. The user then selects the agent to edit and is direct to the appropriate template for editing the desired transfer signal.

          A preferred sample screen display 1500 for selecting the desired data transfer signal for transmitting the generated image data to a FTP server is shown in Figure 15.  
30           The desired agent to which the image data should be sent as shown at 1502. The user then specifies the server settings by selecting the file server 1504 and the file server port 1506 to which the image data is to be transferred. The user then inputs his username 1508 and password on the file server account 1510. The user then selects the transfer settings by

selecting the option to retry when the transfer fails 1512. If the user selects to retry should the transfer fail, the user then inputs the retry count 1514 and the retry interval 1516. The user then provides the destination parameters by specifying the file path 1518 and the file name 1520 for the image data. The file format selected when enabling the system to transmit image data to a plurality of agents as shown in Figure 12 is shown at 1522. Preferably the file format is Multiple Page TIFF. The user can also select whether to overwrite an existing file of the same name by checking the box shown as 1524. The user can then select the OK button 1526 to save the settings or the Cancel button 1528 to cancel the settings entered.

10 A preferred sample screen display 1600 for selecting the desired transfer signal for transmitting the generated image data to a TWAIN agent is shown in Figure 16. The desired agent to which the image data should be send it shown as 1602. The user then specifies the file name 1604 and the folder location 1606 to which the image data is to be sent. The user can then select the OK button 1608 to save the settings or the Cancel button 15 1610 to cancel the settings entered. The file format selected when enabling the system to transmit image data to a plurality of agents as shown in Figure 12 is not shown on this screen. Preferably the file format is Multiple Page TIFF.

A preferred sample screen display 1700 for selecting the desired data transfer signal for transmitting the generated image data to a file is shown in Figure 17. The 20 desired agent to which the image data should be send it shown as 1702. The user then specifies the location of the file 1704, the file path 1706, and the file name 1708. The file format selected when enabling the system to transmit image data to a plurality of agents as shown in Figure 12 is shown at 1710. Preferably the file format is Multiple Page TIFF. The user can then select the OK button 1712 to save the settings or the Cancel button 25 1714 to cancel the settings entered.

Figure 18 shows a preferred sample screen display 1800 for selecting the desired data transfer signal for transmitting the generated image data to an electronic mail address. The desired agent to which the image data should be sent is shown as 1802. The user then enters the name of the person from whom the mail is sent 1804, the return 30 electronic mail address 1806, the name to whom the mail is be sent 1808, the subject of the mail 1810, and any text to accompany the mail 1812. The file format selected when enabling the system to transmit image data to a plurality of agents as shown in Figure 12 is shown at 1814. Preferably the file format is Multiple Page TIFF. The user can also

specify whether there is to be any message fragmentation 1816. The user can then select the OK button 1818 to save the settings or the Cancel button 1820 to cancel the settings entered.

Figure 19 shows a preferred sample screen display 1900 for selecting the desired data transfer signal for transmitting the generated image data to facsimile device. The desired agent to which the image data should be sent is shown as 1902. The user then enters the name of the person from whom the facsimile is sent 1904, the return electronic mail address 1906, the name to whom the facsimile is to be sent 1908, the subject of the facsimile 1910, and any text to accompany the facsimile 1912. The file format selected when enabling the system to transmit image data to a plurality of agents as shown in Figure 12 is shown at 1914. Preferably the file format is Multiple Page TIFF. The user can also specify whether there is to be any message fragmentation 1916. The user can then select the OK button 1918 to save the settings or the Cancel button 1920 to cancel the settings entered.

Figure 20 shows a preferred sample screen display 2000 for selecting the desired data transfer signal for transmitting the generated image data to folder or other storage repository. The desired agent to which the image data should be sent is shown as 2002. The user then specifies the folder name 2004, the type of folder 2006, and the folder path 2008. If the user selects a private folder, then the user must provide the user's login name 2010 and the user's password to access the folder 2012. The user must also reenter or confirm his password as shown as 2014. The user then provides the name of the document as shown as 2016. The user can then select the OK button 2018 to save the settings or the Cancel button 2020 to cancel the settings entered. The file format selected when enabling the system to transmit image data to a plurality of agents as shown in Figure 12 is not shown on this screen. Preferably the file format is Multiple Page TIFF.

Once the user has selected all of the agents to which the generated image data is to be sent, the user initiates the process and the controller 1104 begins the process of transferring the image data to the associated agents. Electronic mail notifications as to the status and any errors are also sent to the user as described above.

While in the preferred embodiment the present invention is implemented in software, as those skilled in the art can readily appreciate it may also be implemented in hardware or a combination of software and hardware.

Although the preferred embodiment has been described in detail, it should be

understood that various changes, substitutions, and alterations can be made therein without departing from the spirit and scope of the invention as defined by the appended claims. It will be appreciated that various changes in the details, materials and arrangements of parts, which have been herein described and illustrated in order to  
5 explain the nature of the invention, may be made by those skilled in the area within the principle and scope of the invention as will be expressed in the appended claims.

What is claimed is:

1. A system for transferring image data from a document reading device to a server comprising:
  - 5 means adapted for receiving image data from an associated document reading device;
  - means adapted for selecting an associated data transfer signal, the data transfer signal including data representative of at least one selected data transfer format and a data transfer target; and
  - 10 means adapted for transmitting the image data via a data transfer system from an associated document reading device to an associated server in accordance with the data transfer selection signal.
2. The system according to claim 1 comprising means adapted for  
15 transmitting image data from the document reading device to a document reading device controller in accordance with the data transfer signal and means adapted for transmitting the image data from the document reading device controller to the server in accordance with the data transfer signal.
- 20 3. The system according to claim 2 wherein the document reading device controller converts the image data to a selected format prior to transmitting the image data to the server.
4. The system according to claim 3 wherein the document reading device  
25 controller first converts the image data to rector format and then converts the image data to the selected format in accordance with the data transfer signal.
5. The system according to claim 1 further comprising means adapted for selecting parameters for generating the image data.
- 30 6. The system according to claim 1 wherein the server is a file transfer protocol server.

7. The system according to claim 1 wherein the data transfer format is selected from the group consisting of TIFF and PDF.

8. The system according to claim 1 wherein the data transfer system is file transfer protocol.

9. The system according to claim 1 wherein the document reading device is selected from the group consisting of an image scanning device and an optical character recognition device.

10

10. A method for transferring image data from a document reading device to a server comprising:

receiving image data from an associated document reading device;

selecting an associated data transfer signal, the data transfer signal

including data representative of at least one selected data transfer format and a data transfer target; and

transmitting the image data via a data transfer system from an associated document reading device to an associated server in accordance with the data transfer selection signal.

20

11. The method according to claim 10 further comprising transmitting image data from the document reading device to a document reading device controller in accordance with the data transfer signal and transmitting the image data from the document reading device controller to the server in accordance with the data transfer signal.

25

11. The method according to claim 11 wherein the document reading device controller converts the image data to a selected format prior to transmitting the image data to the server.

30

13. The method according to claim 12 wherein the document reading device controller first converts the image data to rector format and then converts the image data to the selected format in accordance with the data transfer signal.

14. The method according to claim 10 further comprising selecting parameters for generating the image data.

5 15. The method according to claim 10 wherein the server is a file transfer protocol server.

16. The method according to claim 10 wherein the data transfer format is selected from the group consisting of TIFF and PDF.

10

17. The method according to claim 10 wherein the data transfer system is file transfer protocol.

18. The method according to claim 10 wherein the document reading device is selected from the group consisting of an image scanning device and an optical character recognition device.

15

19. A system for archiving image data received from a document reading device and transferring the archived image data to a server comprising:

20

means adapted for receiving image data from an associated document reading device;

means adapted for selecting an associated data transfer signal, the data transfer signal including data representative of at least one selected data transfer format and a data transfer target;

25

means adapted for compressing and archiving the image data; and  
means adapted for transmitting the image data via a data transfer system from an associated document reading device to an associated server in accordance with the data transfer selection signal.

30

20. The system according to claim 19 comprising means adapted for transmitting image data from the document reading device to a document reading device controller in accordance with the data transfer signal and means adapted for transmitting

the image data from the document reading device controller to the server in accordance with the data transfer signal.

21. The system according to claim 20 wherein the document reading device  
5 controller compresses the image data into a zip file.

22. The system according to claim 19 further comprising means adapted for selecting parameters for generating the image data.

10 23. The system according to claim 19 wherein the server is a file server.

24. The system according to claim 23 wherein the file server is a file transfer protocol server.

15 25. The system according to claim 19 wherein the data transfer system is file transfer protocol.

26. The system according to claim 19 wherein the document reading device is selected from the group consisting of an image scanning device and an optical character  
20 recognition device.

27. A method for archiving image data received from a document reading device and transferring the image data to a server comprising:  
receiving image data from an associated document reading device;  
25 selecting an associated data transfer signal, the data transfer signal including data representative of at least one selected data transfer format and a data transfer target;  
compressing and archiving the image data; and  
transmitting the archived image data via a data transfer system from an  
30 associated document reading device to an associated server in accordance with the data transfer selection signal.

28. The method according to claim 27 further comprising transmitting image data from the document reading device to a document reading device controller in accordance with the data transfer signal and transmitting the image data from the document reading device controller to the server in accordance with the data transfer  
5 signal.

29. The method according to claim 28 wherein the document reading device controller compresses the image data into a zip file.

10 30. The method according to claim 27 further comprising selecting parameters for generating the image data.

31. The method according to claim 27 wherein the server is a file server.

15 32. The method according to claim 31 wherein the file server is a file transfer protocol server.

33. The method according to claim 27 wherein the data transfer system is file transfer protocol.

20 34. The method according to claim 27 wherein the document reading device is selected from the group consisting of an image scanning device and an optical character recognition device.

25 35. A system for performing optical character recognition on image data received from a document reading device comprising:  
means adapted for receiving image data from an associated document reading device;  
means adapted for selecting optical character recognition parameters for  
30 performing optical character recognition on the image data; and  
means adapted for performing optical character recognition on the image data and in accordance with selected optical character recognition parameters.

36. The system according to claim 35 further comprising means adapted for converting the image data to at least one selected format prior to performing optical character recognition on the image data.

5 37. The system according to claim 36 wherein image data is first converted to rector format and is then converted to TIFF format prior to performing optical character recognition on the image data.

10 38. The system according to claim 35 further comprising means adapted for converting the image data to a selected format after performing optical character recognition on the image data.

39. The system according to claim 35 further comprising means adapted for storing the image data after performing optical character recognition on the image data.

15

40. The system according to claim 35 further comprising means adapted for selecting parameters for generating the image data.

20 41. The system according to claim 35 further comprising means adapted for transmitting the image data to a document device reader controller, wherein the controller includes the means adapted for selecting the parameters for optical character recognition and the means adapted for performing optical character recognition on the image data.

25 42. The system according to claim 41 wherein the document reading device controller further comprises means adapted for converting the image data to at least one selected format prior to performing optical character recognition on the image data.

30 43. The system according to claim 41 wherein the document reading device controller further comprises means adapted for converting the image data to a selected format after performing optical character recognition on the image data.

44. The system according to claim 41 wherein the document reading device controller further comprises means adapted for storing the image data after performing optical character recognition on the image data.

5 45. The method for performing optical character recognition on image data received from a document reading device comprising:  
receiving image data from an associated document reading device;  
selecting optical character recognition parameters for performing optical character recognition on the image data; and  
10 performing optical character recognition on the image data and in accordance with selected optical character recognition parameters.

46. The method according to claim 45 further comprising converting the image data to at least one selected format prior to performing optical character recognition on the  
15 image data.

47. The method according to claim 45 wherein image data is first converted to rector format and is then converted to TIFF format prior to performing optical character recognition on the image data.  
20

48. The method according to claim 45 further comprising converting the image data to a selected format after performing optical character recognition on the image data.

49. The method according to claim 45 further comprising storing the image data after performing optical character recognition on the image data.  
25

50. The method according to claim 45 further comprising selecting parameters for generating the image data.

30 51. The method according to claim 45 further comprising transmitting the image data to a document device reader controller, wherein the controller performs the steps of selecting the parameters for optical character recognition performing optical character recognition on the image data.

52. The method according to claim 51 wherein the document reading device controller performs the step of converting the image data to at least one selected format prior to performing optical character recognition on the image data.

5

53. The method according to claim 51 wherein the document reading device controller performs the step of converting the image data to a selected format after performing optical character recognition on the image data.

10

54. The method according to claim 51 wherein the document reading device controller performs the step of storing the image data after performing optical character recognition on the image data.

15

55. A system for transferring image data from a document reading device to a plurality of associated agents comprising:

means adapted for receiving image data from an associated document reading device;

20

means adapted for selecting an associated data transfer signal for each associated agent, wherein each data transfer signal includes data representative of a selected data transfer format and wherein the selected data transfer format is the same for each agent; and

25

means adapted for transmitting the image data via a data transfer system from an associated document reading device to each associated agent in accordance with the data transfer selection signal for each agent, wherein the image data is transmitted sequentially from the document reading device to each agent.

56. The system according to claim 55 wherein the sequence for transmitting the image data to each agent is determined by the document reading device.

30

57. The system according to claim 55 wherein the sequence for transmitting the image data to each agent is determined by each preceding agent.

58. The system according to claim 55 further comprising:

means adapted for transmitting image data from the document reading device to a document reading device controller, and

means adapted for transmitting the image data from the document reading device controller to each associated agent in accordance with the data transfer signal for each agent.

59. The system according to claim 58 wherein the document reading device controller includes at least one selected data storage area, the image data is transmitted from the document reading device into the at least one selected data storage area, and the image data is transmitted from the at least one selected data storage area to each agent in accordance with the data transfer signal for each agent.

60. The system according to claim 59 further comprising means adapted for associating the at least one data storage area with at least one associated user.

15

61. The system according to claim 60 further comprising:

means adapted for prompting an associated user for selected information about the at least one data storage area; and

means adapted for receiving from the associated user selection data designating a user-selected data storage area after prompting the user.

20

62. The system according to claim 58 wherein the selected information includes at least one of data storage area location, data storage area name, access permission, user name associated with the data storage area, and user name password.

25

63. The system according to claim 56 wherein the document reading device controller comprises means adapted to convert the image data to a selected format prior to transmitting the image data to each associated agent.

30

64. The system according to claim 63 wherein the document reading device controller comprises means adapted to first convert the image data to rector format and to then convert the image data to the selected format.

65. The system according to claim 55 further comprising means adapted for selecting parameters for generating the image data.

66. The system according to claim 55 wherein the data transfer format is  
5 selected from the group consisting of TIFF and PDF.

67. The system according to claim 55 wherein the document reading device is an image generating device.

10 68. The system according to claim 55 wherein the associated agents include storage repositories, servers, image generating devices, and optical character recognition systems.

69. A method for transferring image data from a document reading device to a  
15 plurality of associated agents comprising the steps of:

receiving image data from an associated document reading device;  
selecting an associated data transfer signal for each associated agent,  
wherein each data transfer signal includes data representative of a selected data transfer  
format and wherein the selected data transfer format is the same for each agent; and  
20 transmitting the image data via a data transfer system from an associated document reading device to each associated agent in accordance with the data transfer selection signal for each agent, wherein the image data is transmitted sequentially from the document reading device to each agent.

25 70. The method according to claim 69 wherein the sequence for transmitting the image data to each agent is determined by the document reading device.

71. The method according to claim 69 wherein the sequence for transmitting the image data to each agent is determined by each preceding agent.

30 72. The method according to claim 69 further comprising the steps of:  
transmitting image data from the document reading device to a document reading device controller, and

transmitting the image data from the document reading device controller to each associated agent in accordance with the data transfer signal for each agent.

73. The method according to claim 72 wherein the document reading device controller includes at least one selected data storage area, the image data is transmitted from the document reading device into the at least one selected data storage area, and the image data is transmitted from the at least one selected data storage area to each agent in accordance with the data transfer signal for each agent.

74. The method according to claim 69 further comprising the step of associating the at least one data storage area with at least one associated user.

75. The method according to claim 74 further comprising the steps of:  
prompting an associated user for selected information about the at least one data storage area; and  
receiving from the associated user selection data designating a user-selected data storage area after prompting the user.

76. The method according to claim 75 wherein the selected information includes at least one of data storage area location, data storage area name, access permission, user name associated with the data storage area, and user name password.

77. The method according to claim 72 further comprising the step of converting the image data by the document reading device controller to a selected format prior to transmitting the image data to each associated agent.

78. The method according to claim 77 wherein the image data is first converted to rector format and the image data is then converted to the selected format.

79. The method according to claim 69 further comprising the step of selecting parameters for generating the image data.

80. The method according to claim 69 wherein the data transfer format is selected from the group consisting of TIFF and PDF.

81. The method according to claim 69 wherein the document reading device is  
5 an image generating device.

82. The method according to claim 69 wherein the associated agents include storage repositories, servers, image generating devices, and optical character recognition systems.

10

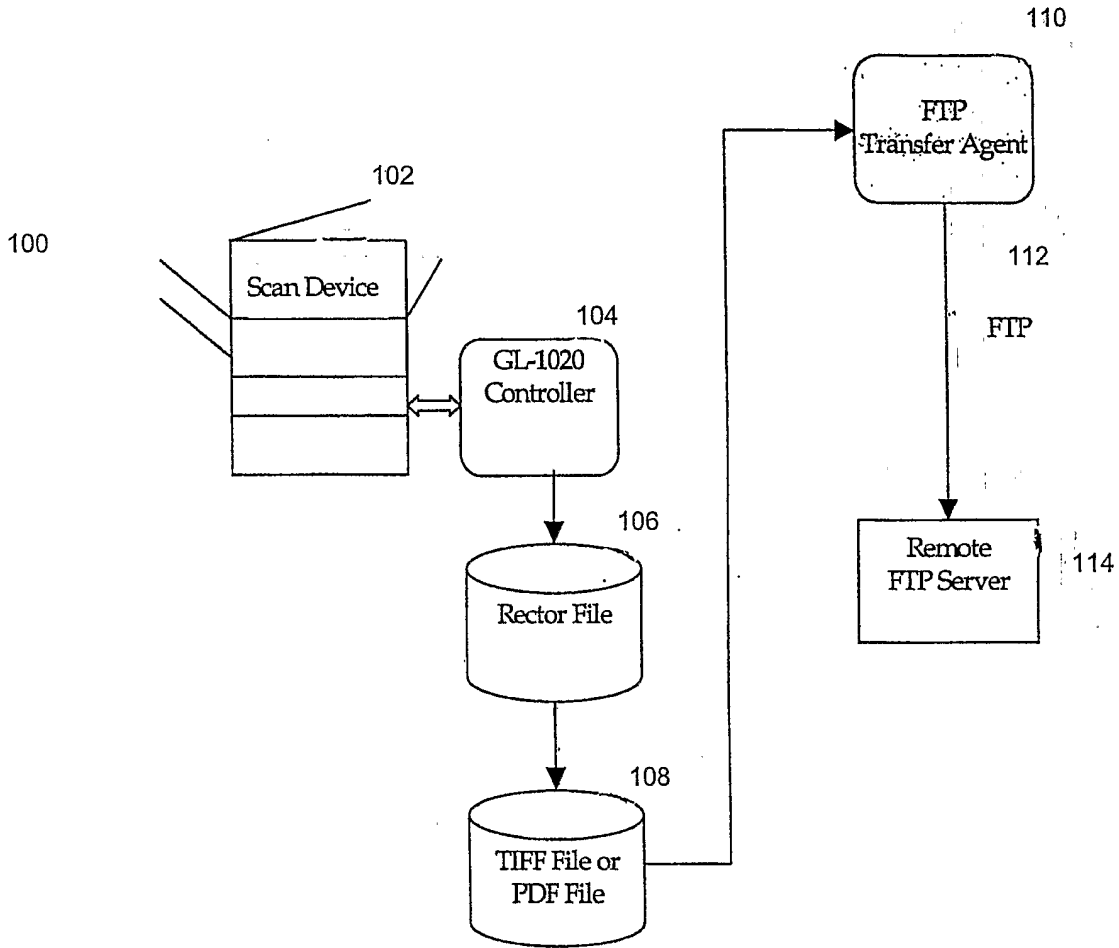

FIG. 1

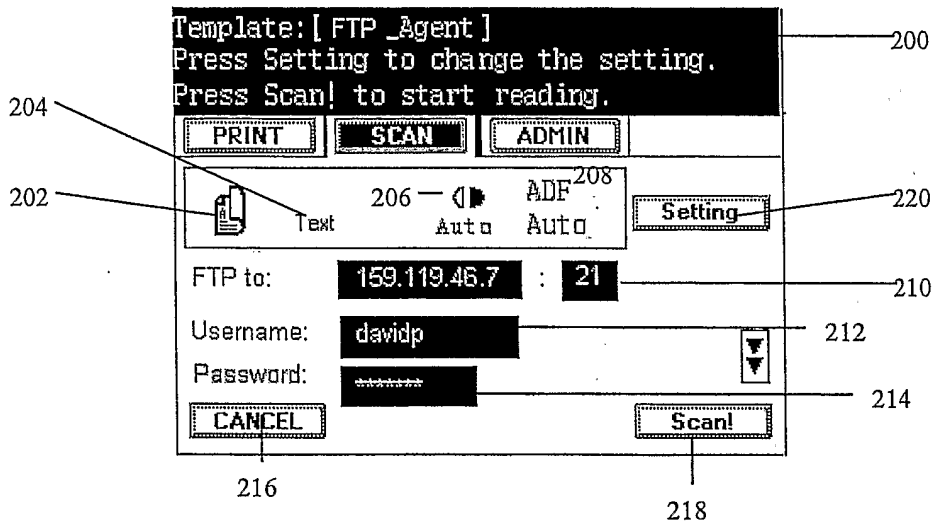

Figure 2a

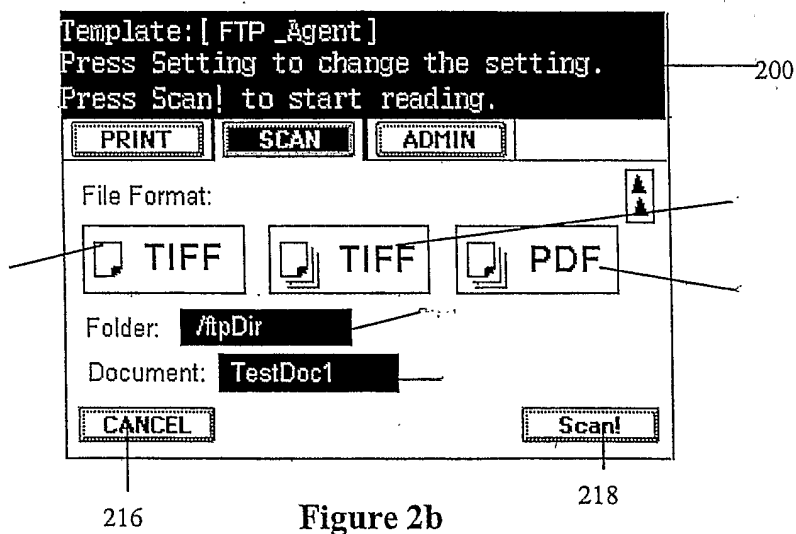

Figure 2b

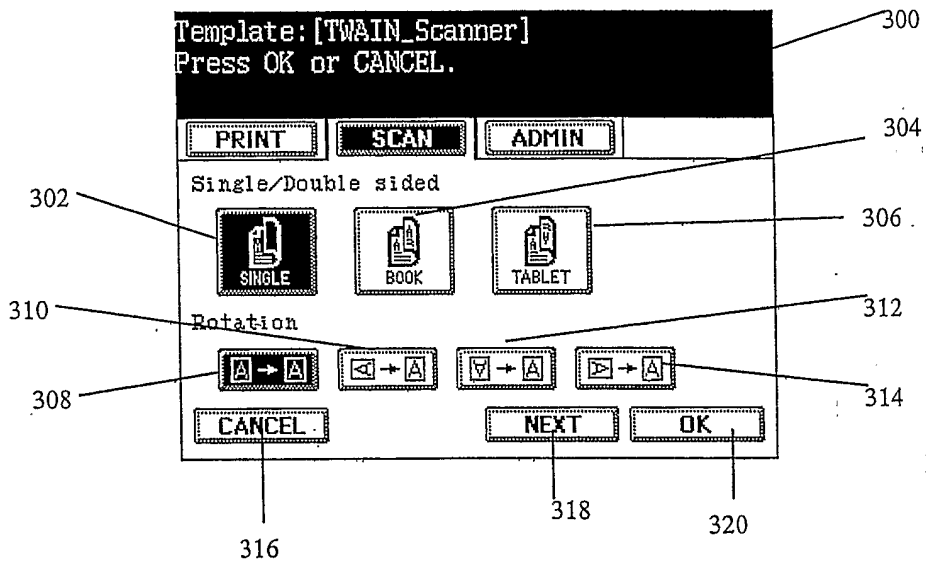

Figure 3a

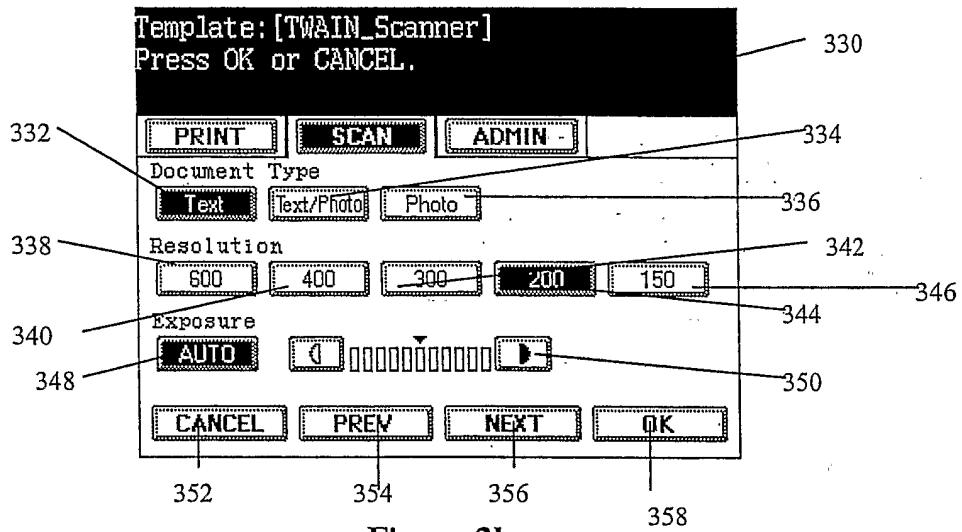

Figure 3b

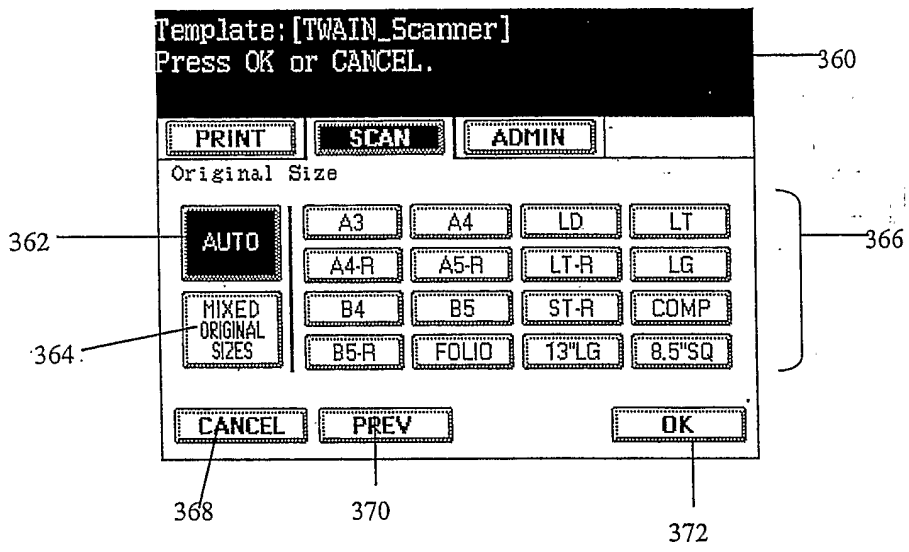

Figure 3c

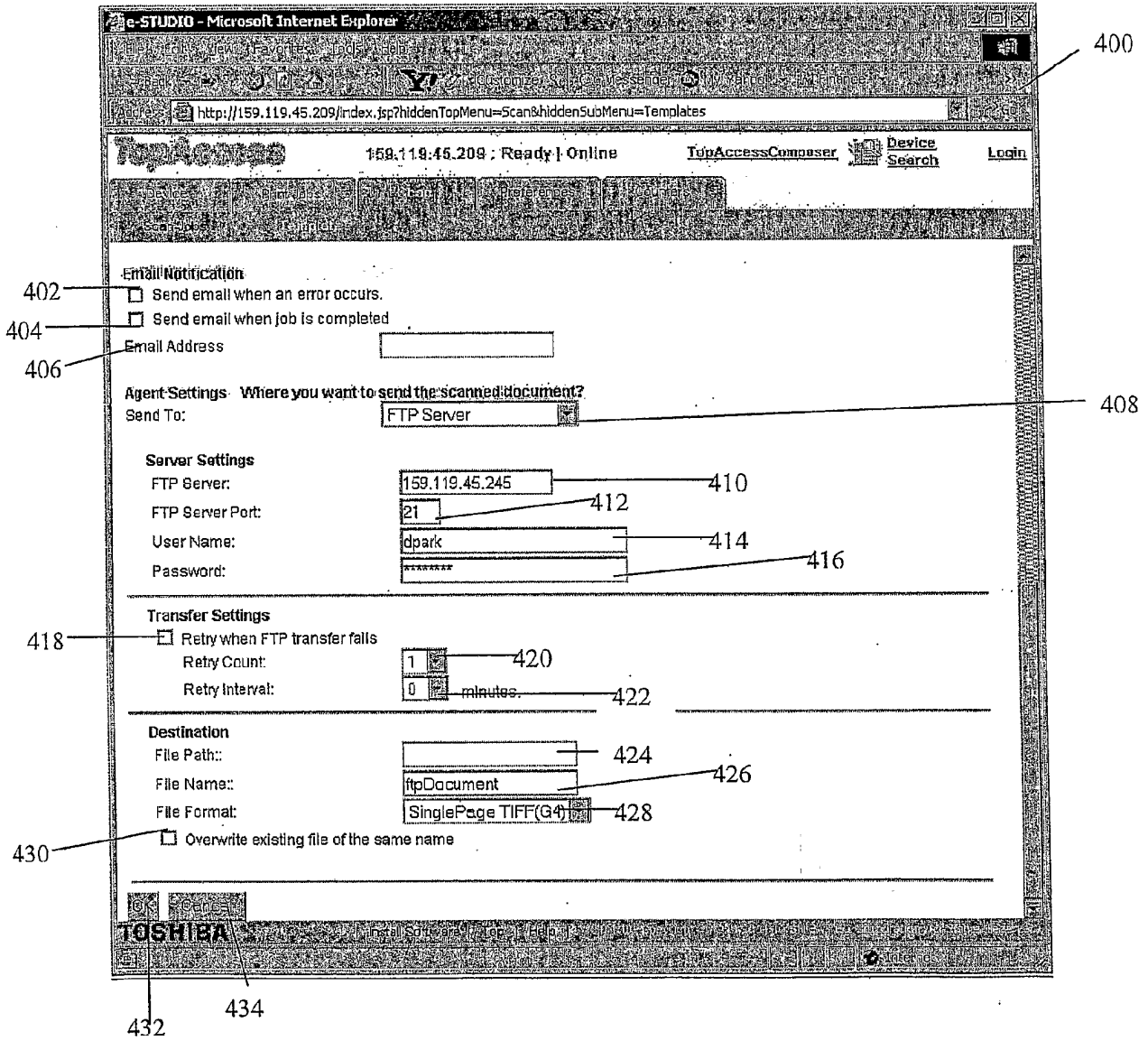

Figure 4

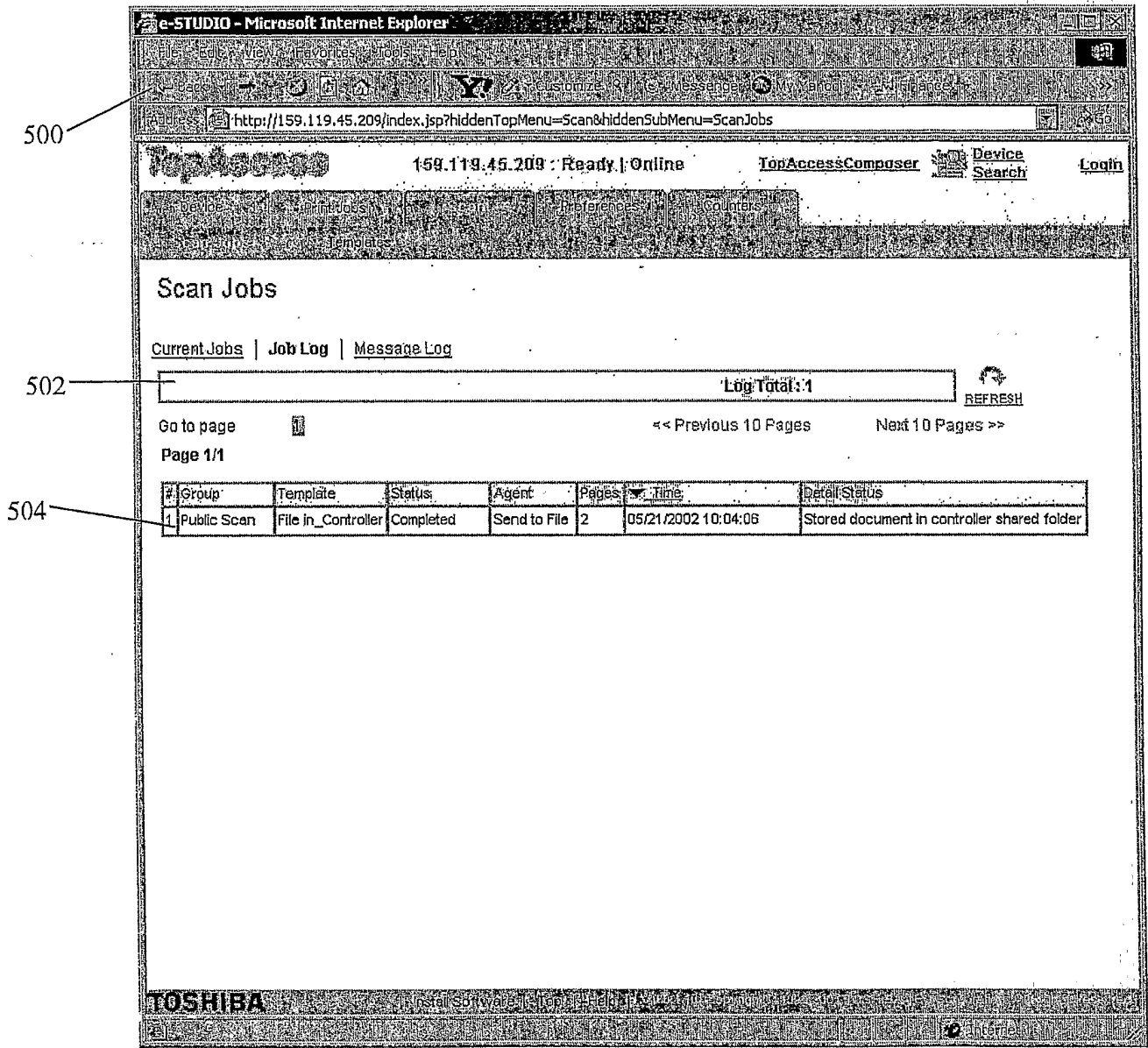

Figure 5

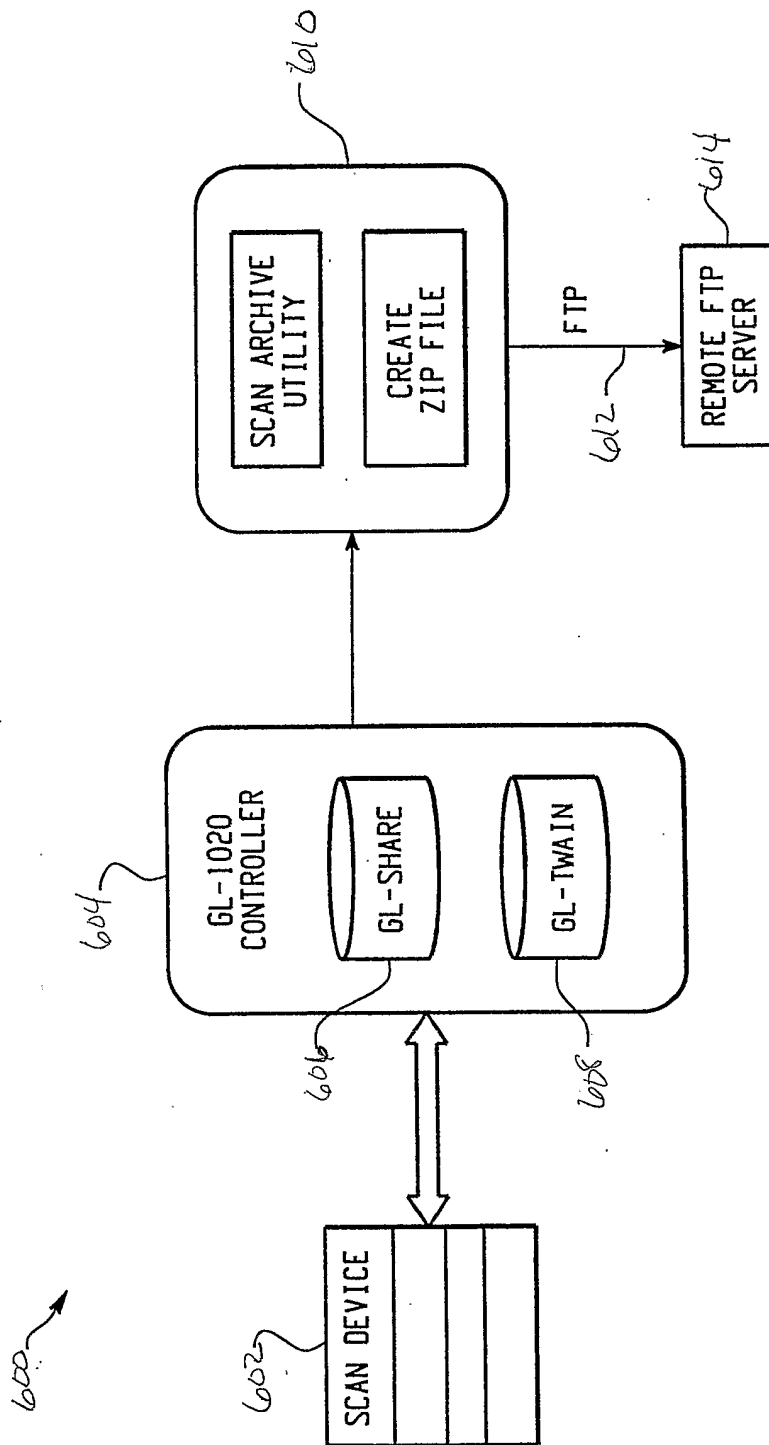

Fig. 6

706

e-STUDIO-Microsoft Internet Explorer  
File Edit View Favorites Tools Help

TopAccess  
Device: Ready | Online  
Logout

Device | Print Jobs | Scan | Preferences | Counters | Administration

ARCHIVE  
The archived data will be stored in a zip and transferred to an FTP site.

Archive OL-Share data  
 Archive GL-TWAIN data

Archive File  
FTP Server: 159.119.45.2  
FTP server Port: 21  
User ID: root  
Password: \*\*\*\*\*  
File Name: sc3.zip  
File Path: /preetharn/

Overwrite existing file of the same name

702 708 710 712 714 716 718 720 722 724

Archive Set Reset  
 Shutdown  Reboot  Offline  Print Device Configuration  Print PCL Fonts  Print PS Fonts

Internet

Fig. 7

e-STUDIO-Internet Explorer  
 File Edit View Favorites Tools Help  
 Back Home Stop Refresh My Finance >>  
 Address http://159.119.45.209/index.jsp?hiddenTopMenu = Scan&hiddenSubMenu = Scan.Jobs  
 TopAccess 159.119.45.209:Ready | Online  
 Device Print Jobs Scan Preferences Counters  
 Scan Jobs  
 Current Jobs Job Log Message Log  
 Log Total: 1 REFRESH  
 Go to page 1 << Previous 10 Pages Next 10 Pages >>  
 Page 1/1

#	Group	Template	Status	Agent	Pages	Time	Detail Status
1	Public Scan	File in _Controller	Completed	Send to File	2	05/21/2002 10:04:06	Stored document in controller shared folder

Internet

800

802

804

Fig. 8

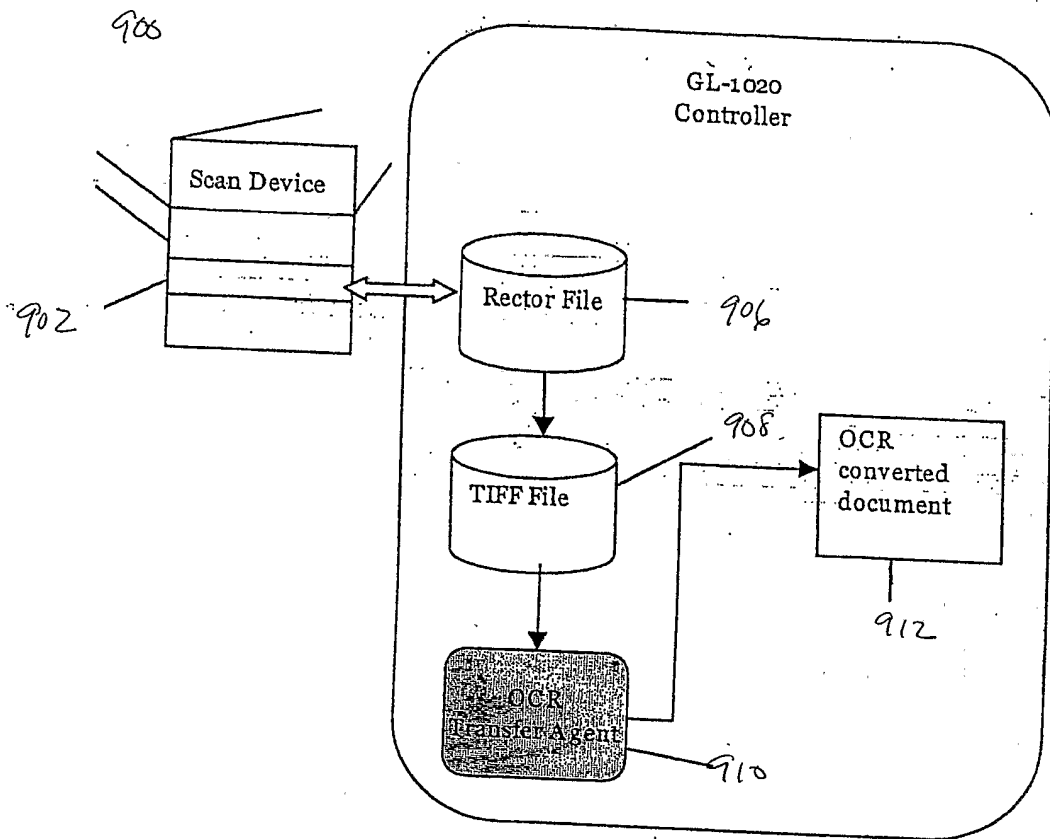

FIG. 9

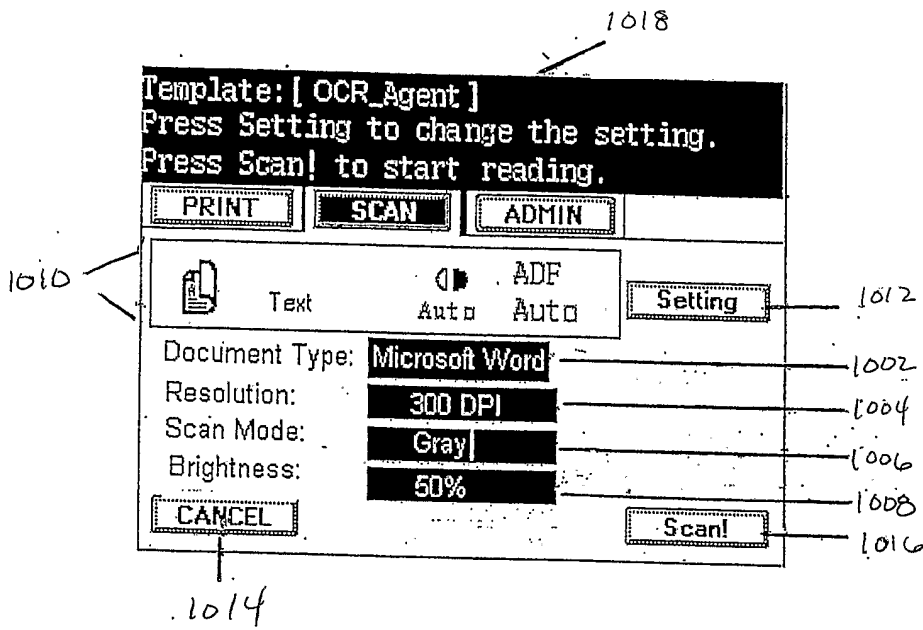

FIG. 10

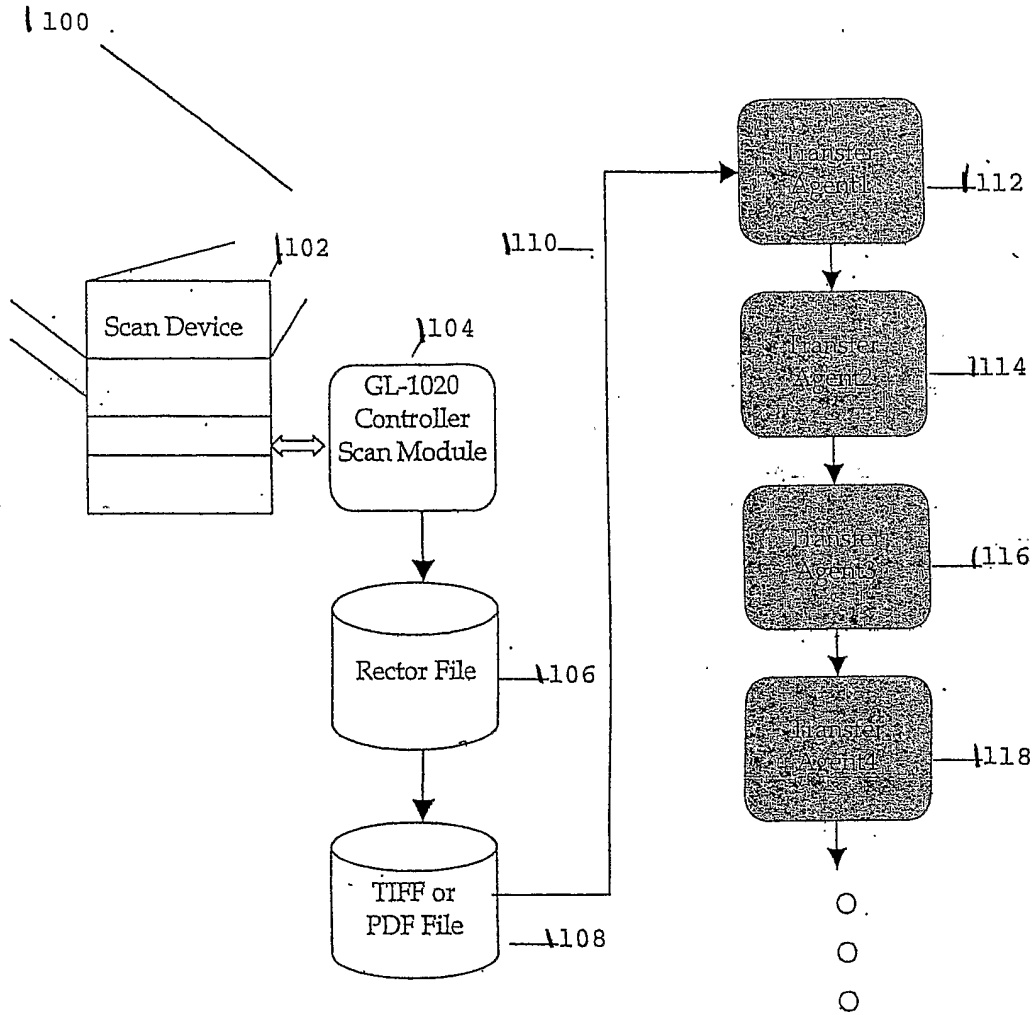

Fig. 11

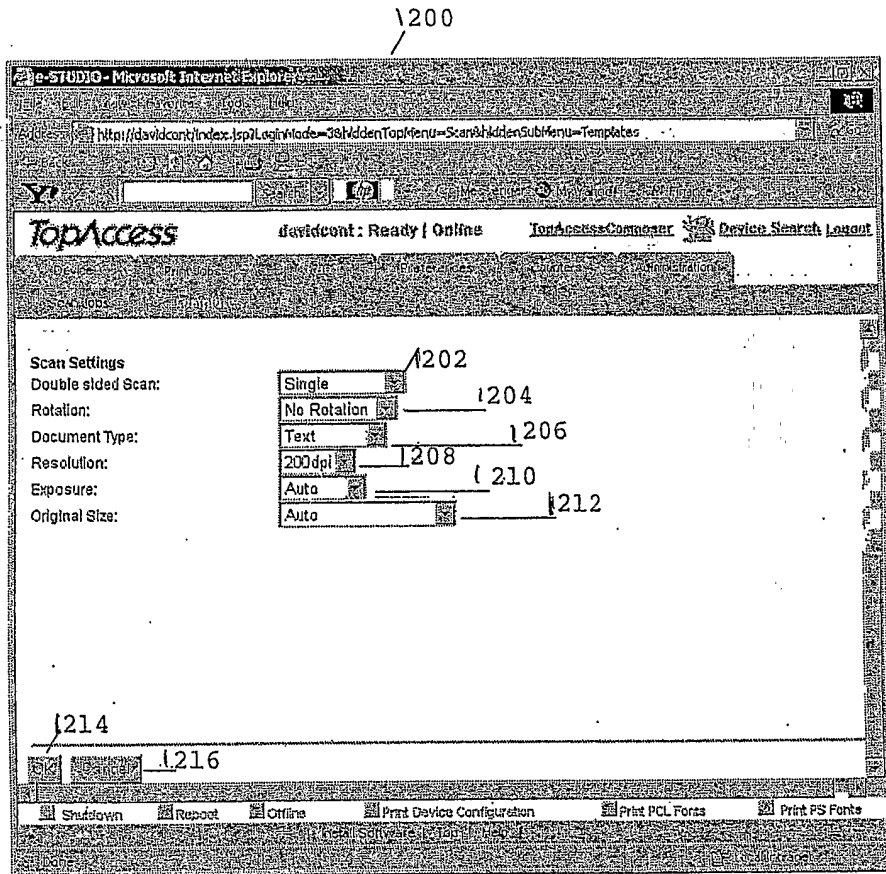

Fig.12

1300

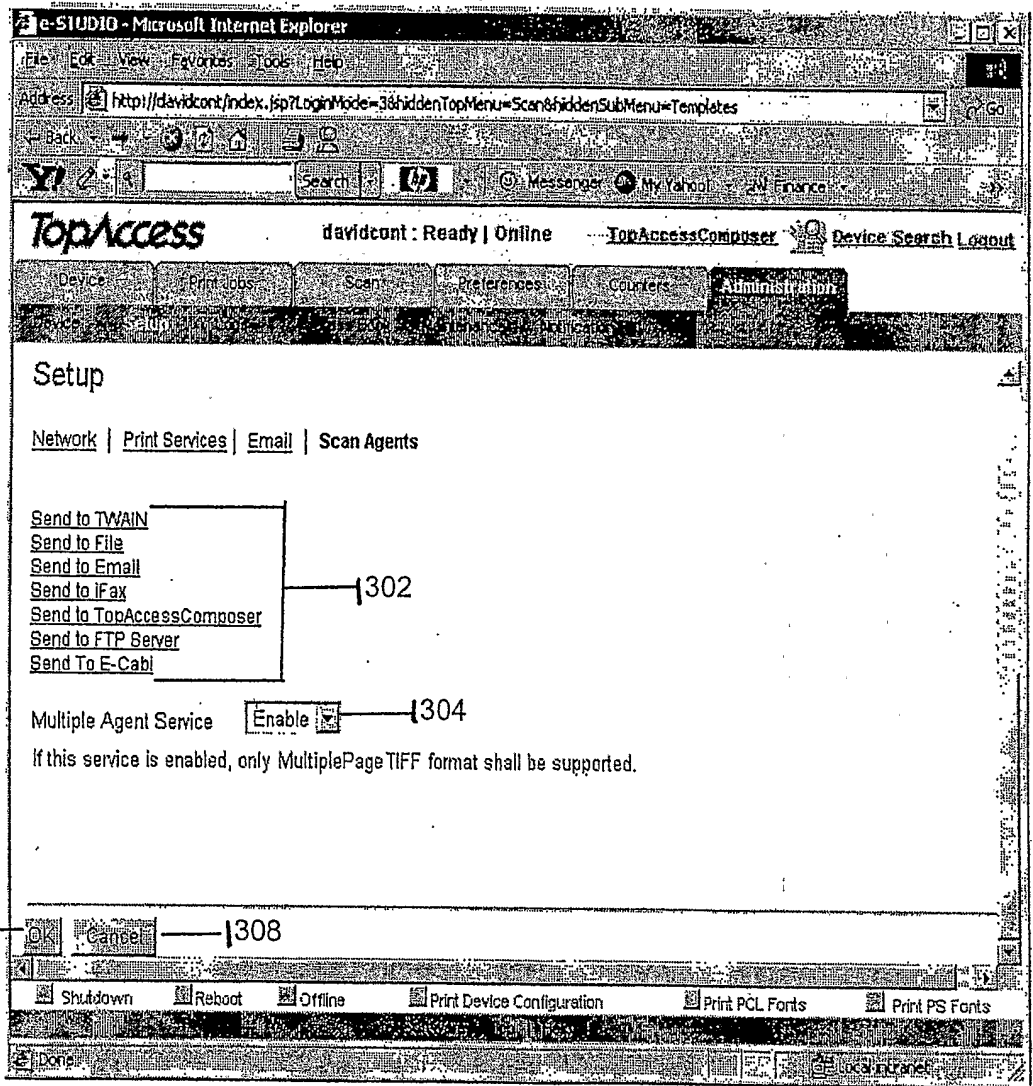

Fig.13

1400

The screenshot shows a web browser window with the address bar containing a URL. The main content area is titled "Mail Box Properties (TBD)" and includes a "Mail Box" dropdown menu with options 1418, 1420, 1422, and 1424. Below this are buttons for "Edit", "Change Password", "Delete", "Add Agent", "Delete Agent", and "Ban Agent". A table below the buttons contains the following data:

Box No.	1001
Password	The email box is password protected.
Email Notification	hirayuki_kato@postibales.co.jp
<input type="checkbox"/> Agent 1	Scan to File
<input type="checkbox"/> Agent 2	Scan to FTP
<input type="checkbox"/> Agent 3	Scan to Email

Callouts 1414, 1402, 1406, and 1410 point to the "Edit", "Change Password", "Delete", and "Agent 1" row respectively. Callouts 1404, 1408, and 1412 point to the "Password", "Email Notification", and "Agent 3" row respectively.

Fig.14

1500

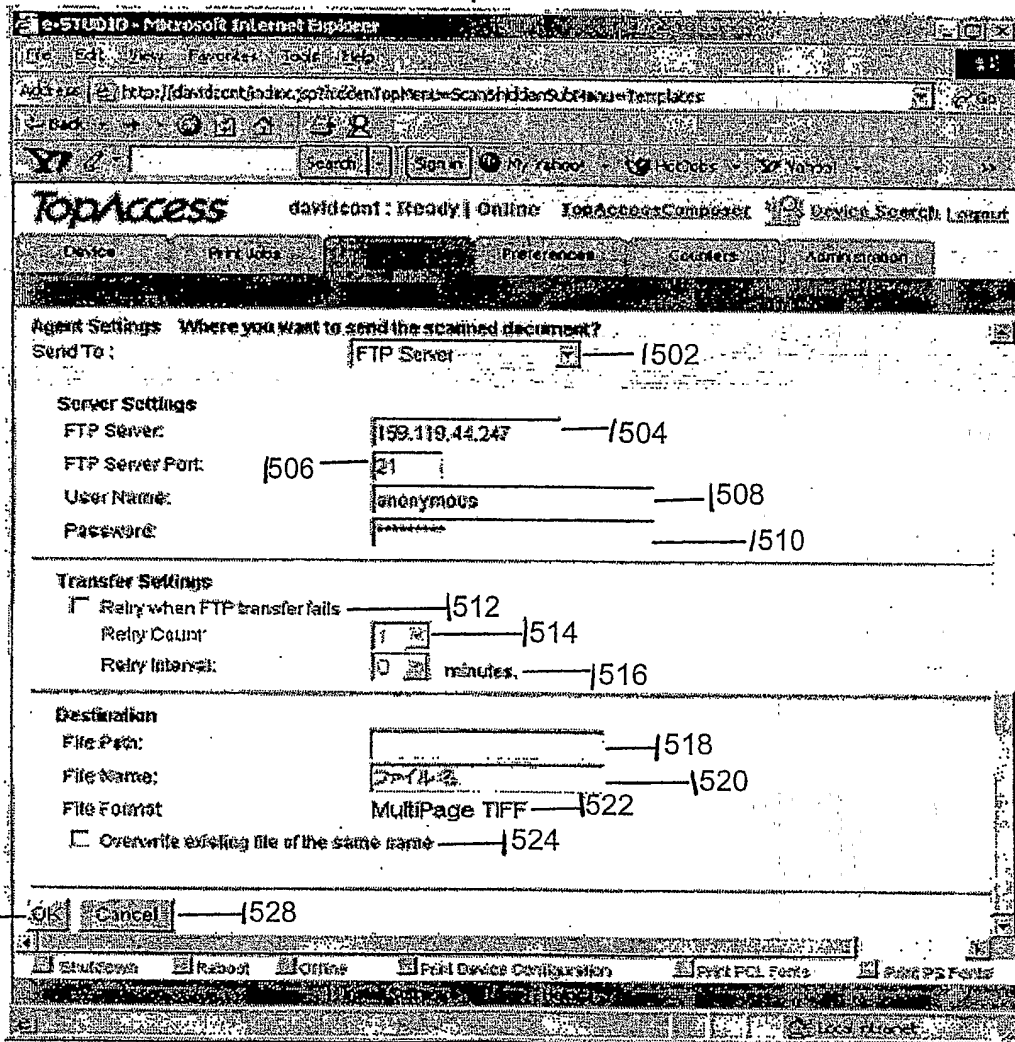

Fig.15

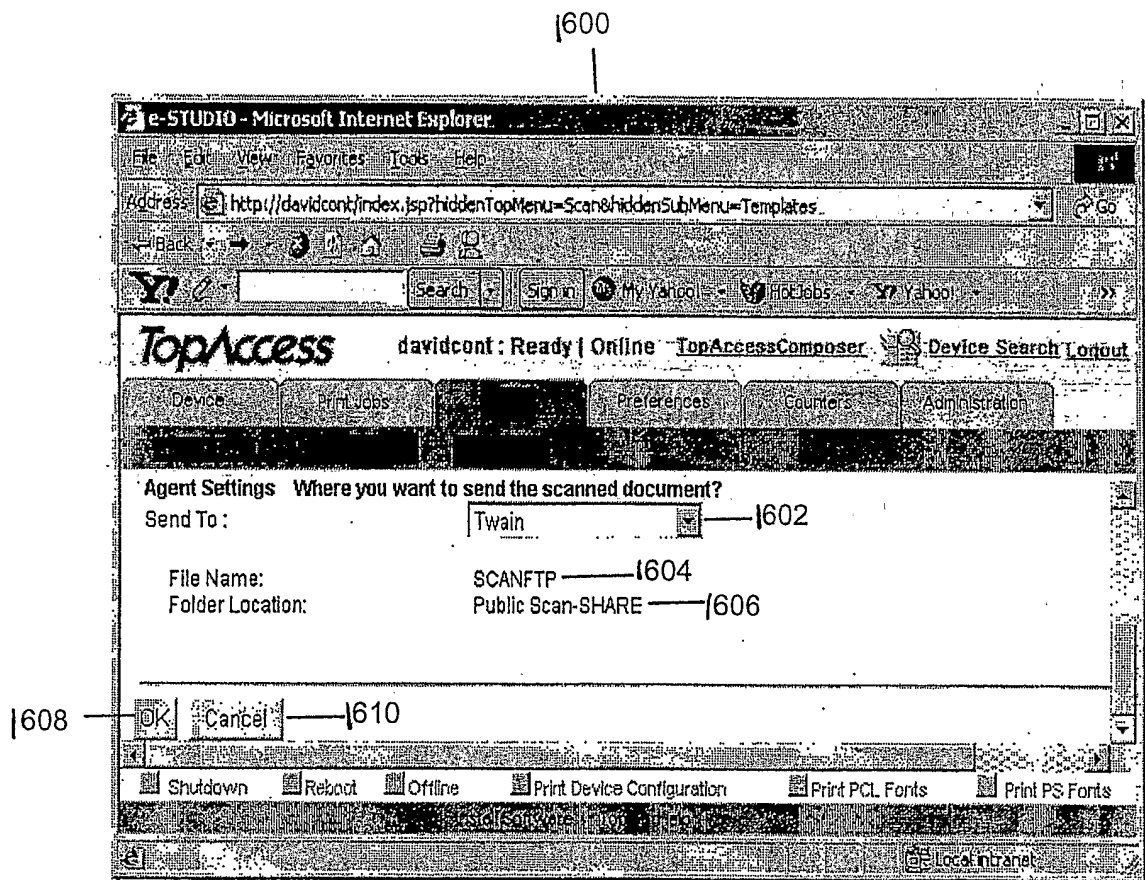

Fig. 16

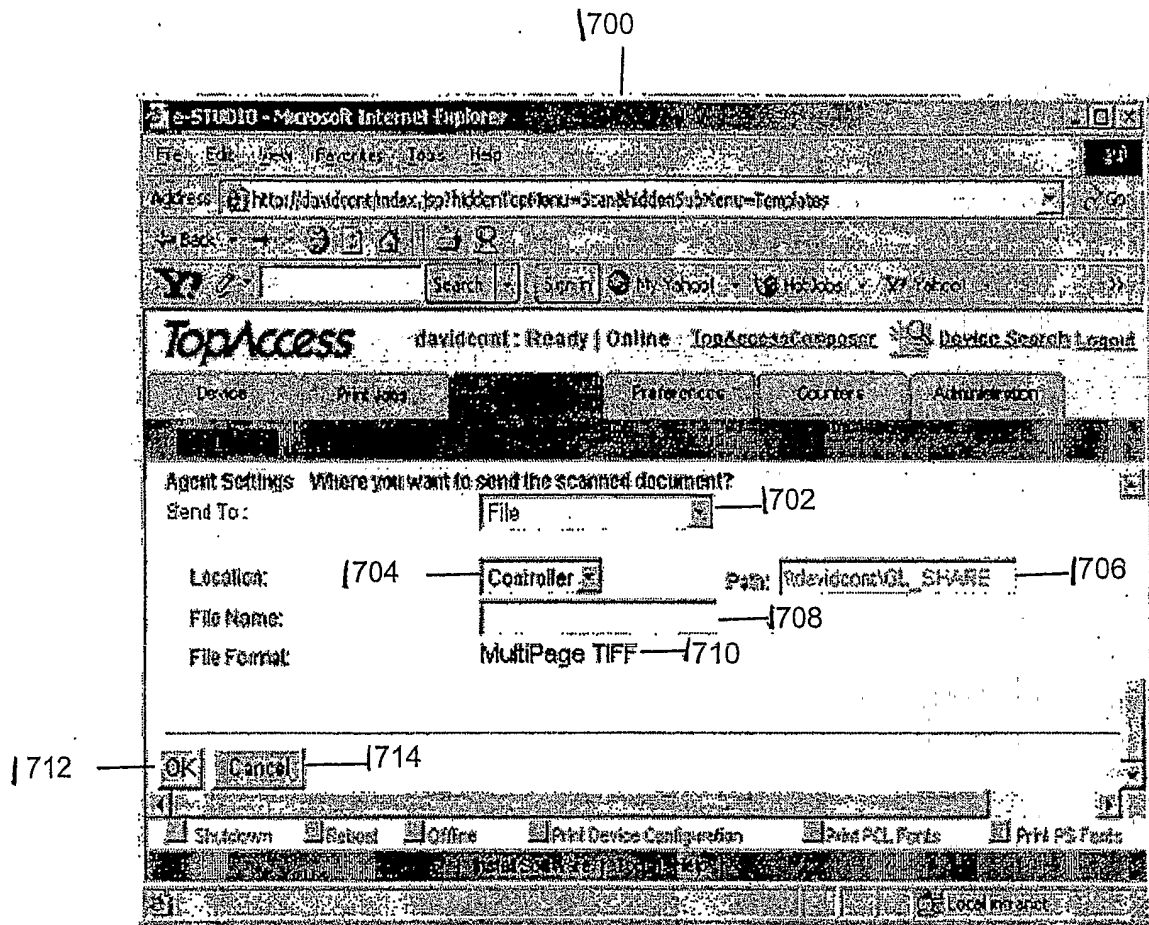

Fig.17

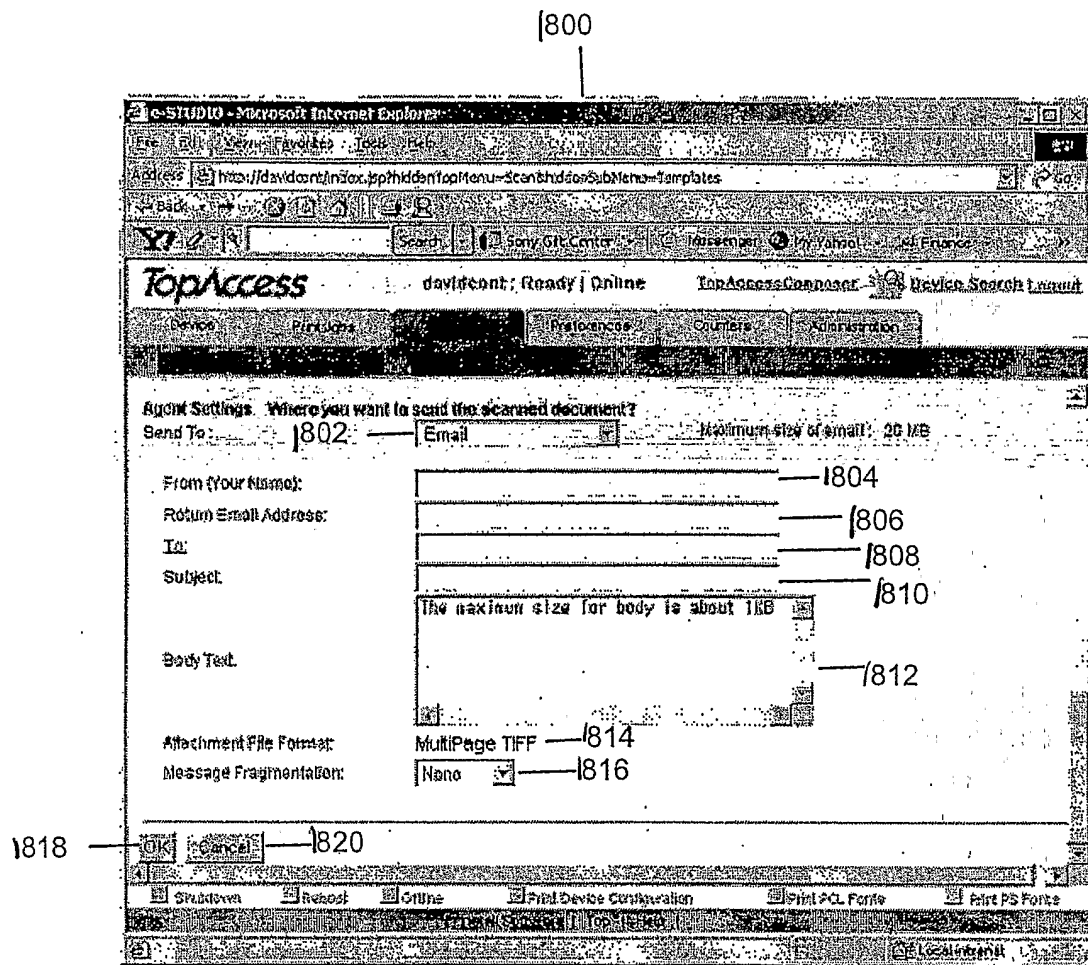

Fig.18

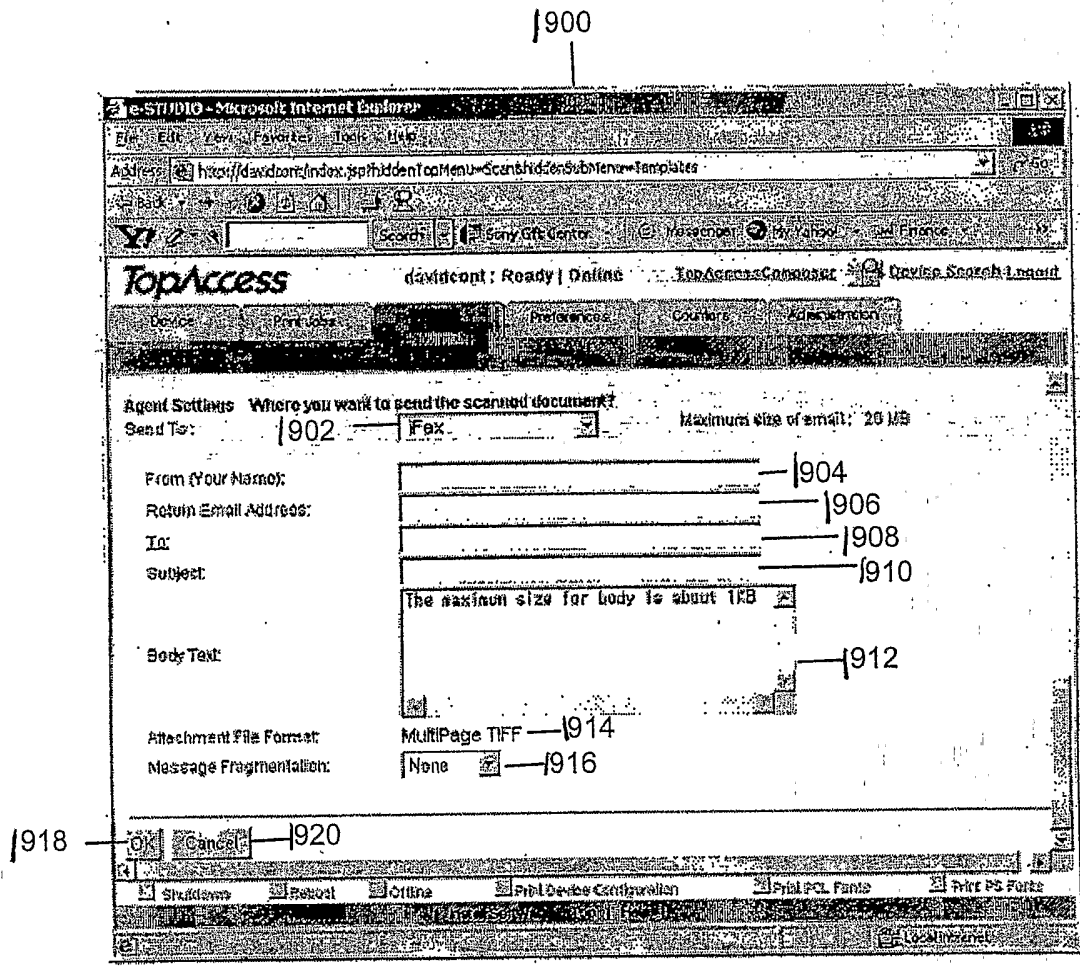

Fig. 19

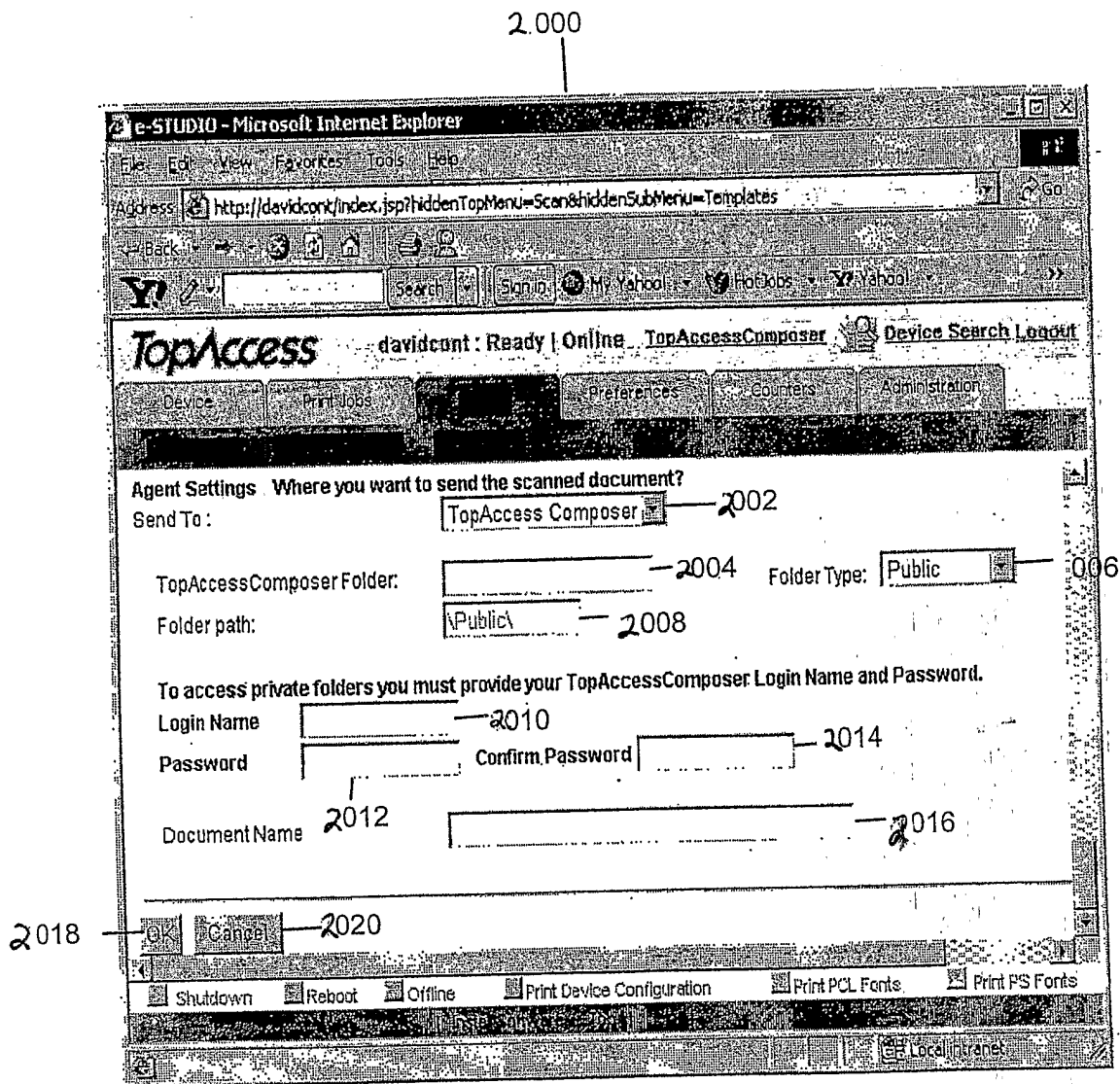

Fig. 20

**INTERNATIONAL SEARCH REPORT**

International application No.  
PCT/US03/16991

<b>A. CLASSIFICATION OF SUBJECT MATTER</b>												
IPC(7) : G06F 15/16 US CL : 709/219, 214, 217, 223, 224; 395/114, 113, 106; 700/2, 4, 9; 235/462.01 According to International Patent Classification (IPC) or to both national classification and IPC												
<b>B. FIELDS SEARCHED</b>												
Minimum documentation searched (classification system followed by classification symbols) U.S. : 709/219, 214, 217, 223, 224; 395/114, 113, 106; 700/2, 4, 9; 235/462.01												
Documentation searched other than minimum documentation to the extent that such documents are included in the fields searched												
Electronic data base consulted during the international search (name of data base and, where practicable, search terms used)												
<b>C. DOCUMENTS CONSIDERED TO BE RELEVANT</b>												
Category *	Citation of document, with indication, where appropriate, of the relevant passages	Relevant to claim No.										
Y	US 5,768,483 (MANIWA et al) 16 June 1998 (16.06.1998), figures 5,7; col. 2, lines 55 through col. 3, lines 67; col. 15, lines 42 through col. 17, 1st paragraph	1-82										
Y,E	US 6,587,735 B1 (YAGUCHI) 01 July 2003 (01.07.2003), figures 1,4,7, and 13; col. 11, lines 17 through col. 14, lines 18	1-82										
A	US 6,152,369 (WILZ, Sr. et al) 28 November 2000 (28.11.2000), figures 1,2,4, and 5; col. 2, lines 53 thorough col. 6, lines 25	1-82										
<input type="checkbox"/> Further documents are listed in the continuation of Box C. <input type="checkbox"/> See patent family annex.												
* Special categories of cited documents: <table border="0"> <tr> <td>"A" document defining the general state of the art which is not considered to be of particular relevance</td> <td>"T" later document published after the international filing date or priority date and not in conflict with the application but cited to understand the principle or theory underlying the invention</td> </tr> <tr> <td>"E" earlier application or patent published on or after the international filing date</td> <td>"X" document of particular relevance; the claimed invention cannot be considered novel or cannot be considered to involve an inventive step when the document is taken alone</td> </tr> <tr> <td>"L" document which may throw doubts on priority claim(s) or which is cited to establish the publication date of another citation or other special reason (as specified)</td> <td>"Y" document of particular relevance; the claimed invention cannot be considered to involve an inventive step when the document is combined with one or more other such documents, such combination being obvious to a person skilled in the art</td> </tr> <tr> <td>"O" document referring to an oral disclosure, use, exhibition or other means</td> <td>"&amp;" document member of the same patent family</td> </tr> <tr> <td>"P" document published prior to the international filing date but later than the priority date claimed</td> <td></td> </tr> </table>			"A" document defining the general state of the art which is not considered to be of particular relevance	"T" later document published after the international filing date or priority date and not in conflict with the application but cited to understand the principle or theory underlying the invention	"E" earlier application or patent published on or after the international filing date	"X" document of particular relevance; the claimed invention cannot be considered novel or cannot be considered to involve an inventive step when the document is taken alone	"L" document which may throw doubts on priority claim(s) or which is cited to establish the publication date of another citation or other special reason (as specified)	"Y" document of particular relevance; the claimed invention cannot be considered to involve an inventive step when the document is combined with one or more other such documents, such combination being obvious to a person skilled in the art	"O" document referring to an oral disclosure, use, exhibition or other means	"&" document member of the same patent family	"P" document published prior to the international filing date but later than the priority date claimed	
"A" document defining the general state of the art which is not considered to be of particular relevance	"T" later document published after the international filing date or priority date and not in conflict with the application but cited to understand the principle or theory underlying the invention											
"E" earlier application or patent published on or after the international filing date	"X" document of particular relevance; the claimed invention cannot be considered novel or cannot be considered to involve an inventive step when the document is taken alone											
"L" document which may throw doubts on priority claim(s) or which is cited to establish the publication date of another citation or other special reason (as specified)	"Y" document of particular relevance; the claimed invention cannot be considered to involve an inventive step when the document is combined with one or more other such documents, such combination being obvious to a person skilled in the art											
"O" document referring to an oral disclosure, use, exhibition or other means	"&" document member of the same patent family											
"P" document published prior to the international filing date but later than the priority date claimed												
Date of the actual completion of the international search		Date of mailing of the international search report										
04 September 2003 (04.09.2003)		02 OCT 2003										
Name and mailing address of the ISA/US Mail Stop PCT, Attn: ISA/US Commissioner for Patents P.O. Box 1450 Alexandria, Virginia 22313-1450 Facsimile No. (703)305-3230		Authorized officer David A Wiley Telephone No. 703-305-3900 <i>Peggy Harwood</i>										