



US00D842838S

(12) **United States Design Patent**
Li

(10) **Patent No.:** **US D842,838 S**

(45) **Date of Patent:** **** Mar. 12, 2019**

- (54) **HEADSET**
- (71) Applicant: **Qunru Li**, Guangdong (CN)
- (72) Inventor: **Qunru Li**, Guangdong (CN)
- (**) Term: **15 Years**
- (21) Appl. No.: **29/619,440**
- (22) Filed: **Sep. 29, 2017**
- (51) **LOC (11) Cl.** **14-01**
- (52) **U.S. Cl.**
USPC **D14/205**
- (58) **Field of Classification Search**
USPC D14/205, 223, 371; 181/129, 130, 135;
379/430, 431; 381/380, 381, 74, 384,
381/385, 151; 345/7, 8; 455/90.3, 575.1,
455/569.1
CPC H04R 1/105; H04R 1/10; H04R 25/00;
H04R 1/1066; H04R 1/02; H04R 1/1041;
H04R 5/033; H04R 5/0335
See application file for complete search history.

- 6,010,216 A * 1/2000 Jesiek H04B 1/385
351/158
- 6,123,168 A * 9/2000 Berg F16C 11/12
128/866
- 6,233,345 B1 * 5/2001 Urwyler H04R 1/1033
351/123
- D457,515 S * 5/2002 Masamitsu D14/192
- D458,245 S * 6/2002 Masuda D14/192
- D471,176 S * 3/2003 Suzuki D14/205
- 6,603,863 B1 * 8/2003 Nagayoshi H04R 1/1066
381/370
- D492,943 S * 7/2004 Komiyama D14/205
- 7,010,139 B1 * 3/2006 Smeehuyzen H04R 1/10
381/376
- D557,685 S * 12/2007 Lee D14/205
- D573,581 S * 7/2008 Gondo D14/205
- D575,268 S * 8/2008 Christopher D14/205
- D587,679 S * 3/2009 Komiyama D14/205
- D590,810 S * 4/2009 Komiyama D14/205
- D593,067 S * 5/2009 Millora D14/205

(Continued)

Primary Examiner — Paula Allen Greene

(57) **CLAIM**

The ornamental design for a headset, as shown and described.

DESCRIPTION

FIG. 1 is a perspective view of a headset showing my new design;
 FIG. 2 is a front elevational view thereof;
 FIG. 3 is a rear elevational view thereof;
 FIG. 4 is a left side elevational view thereof;
 FIG. 5 is a right side elevational view thereof;
 FIG. 6 is a top plan view thereof;
 FIG. 7 is a bottom plan view thereof;
 FIG. 8 is a perspective view of the headset showing earbuds being pulled out; and,
 FIG. 9 is a perspective view of the headset showing hinges being folded.

1 Claim, 9 Drawing Sheets

(56) **References Cited**
U.S. PATENT DOCUMENTS

- 2,501,107 A * 3/1950 Volkmann H04R 5/0335
381/374
- 2,891,116 A * 6/1959 Nichols H04R 25/60
381/323
- 3,863,028 A * 1/1975 Fixler H04R 1/1075
381/19
- 4,110,583 A * 8/1978 Lepper H04M 1/05
381/370
- 4,821,318 A * 4/1989 Wu H04M 1/05
379/430
- D371,558 S * 7/1996 Yoshizawa D14/205
- 5,749,373 A * 5/1998 Dix A61F 11/12
128/864
- 5,829,062 A * 11/1998 Magidson A61F 11/12
2/209

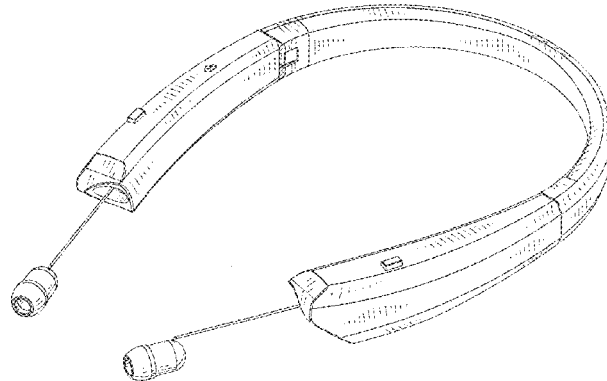
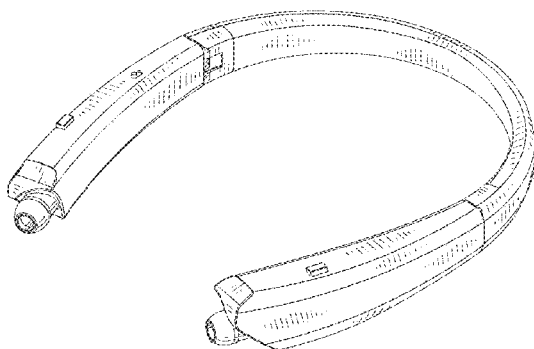

(56)

References Cited

U.S. PATENT DOCUMENTS

D604,269	S *	11/2009	Choe	D14/205
D633,471	S *	3/2011	Sugiyama	D14/205
D653,234	S *	1/2012	Lee	D14/205
D665,008	S *	8/2012	Olsson	D16/300
8,290,193	B2 *	10/2012	Pang	H04R 1/1033 381/370
8,433,082	B2 *	4/2013	Abolfathi	H04R 1/46 381/151
D685,764	S *	7/2013	Coulter	D14/205
D716,759	S *	11/2014	Ha	D14/205
D721,673	S *	1/2015	Park	D14/205
8,934,654	B2 *	1/2015	Fullam	H04R 1/028 381/381
D726,649	S *	4/2015	Lee	D13/103
D730,867	S *	6/2015	Park	D14/205
D731,999	S *	6/2015	Cepress	D14/205
D743,933	S *	11/2015	Park	D14/205
D745,490	S *	12/2015	Zheng	D14/205
D762,617	S *	8/2016	Park	D14/205
D766,869	S *	9/2016	Lee	D14/205
9,445,181	B1 *	9/2016	Atwater	H04R 1/105
D768,600	S *	10/2016	Chen	D14/205
D771,013	S *	11/2016	Yang	D14/205
D771,588	S *	11/2016	Choe	D14/205
D772,843	S *	11/2016	Lee	D14/205
D772,845	S *	11/2016	Lim	D14/205
D774,017	S *	12/2016	Ahn	D14/205
D776,636	S *	1/2017	Lim	D14/205
D777,136	S *	1/2017	Erbeus	D14/205
D781,815	S *	3/2017	Choi	D14/205
D781,816	S *	3/2017	Choe	D14/205
D793,357	S *	8/2017	Afshar	D14/205
D793,358	S *	8/2017	Lee	D14/205
D795,836	S *	8/2017	Liden	D14/205
D800,088	S *	10/2017	Kim	D14/205
D800,089	S *	10/2017	Park	D14/205
D800,090	S *	10/2017	Ahn	D14/205
D802,557	S *	11/2017	Kumano	D14/205
D802,558	S *	11/2017	Kim	D14/205
D803,186	S *	11/2017	Park	D14/205
D810,719	S *	2/2018	Nagamine	D14/205
D815,068	S *	4/2018	Huang	D14/223
D816,636	S *	5/2018	Birger	D14/205
9,973,842	B2 *	5/2018	Kim	H04R 1/1025
D820,811	S *	6/2018	Kim	D14/205
D820,816	S *	6/2018	Singh	D14/223
D823,828	S *	7/2018	Park	D14/205
D824,361	S *	7/2018	Park	D14/205
D824,877	S *	8/2018	Kim	D14/205
D826,898	S *	8/2018	Kim	D14/205
D826,899	S *	8/2018	Ahn	D14/205
D830,335	S *	10/2018	Shin	D14/205
2011/0170702	A1 *	7/2011	Bays	H04R 5/0335 381/74
2013/0156250	A1 *	6/2013	Hsu Huang	H04R 1/1075 381/385
2013/0329903	A1 *	12/2013	Ting	H04R 1/105 381/74
2015/0264474	A1 *	9/2015	Seo	G06F 3/165 381/74
2016/0050487	A1 *	2/2016	Kim	H04R 1/323 381/74
2016/0366506	A1 *	12/2016	Kim	H04R 5/0335
2017/0070801	A1 *	3/2017	Nguyen	H04R 1/105
2017/0195768	A1 *	7/2017	Kim	H04B 1/034
2017/0311072	A1 *	10/2017	Seo	H04M 1/02
2017/0347192	A1 *	11/2017	Seo	H04R 5/02
2018/0063620	A1 *	3/2018	Kim	H04R 1/1025

* cited by examiner

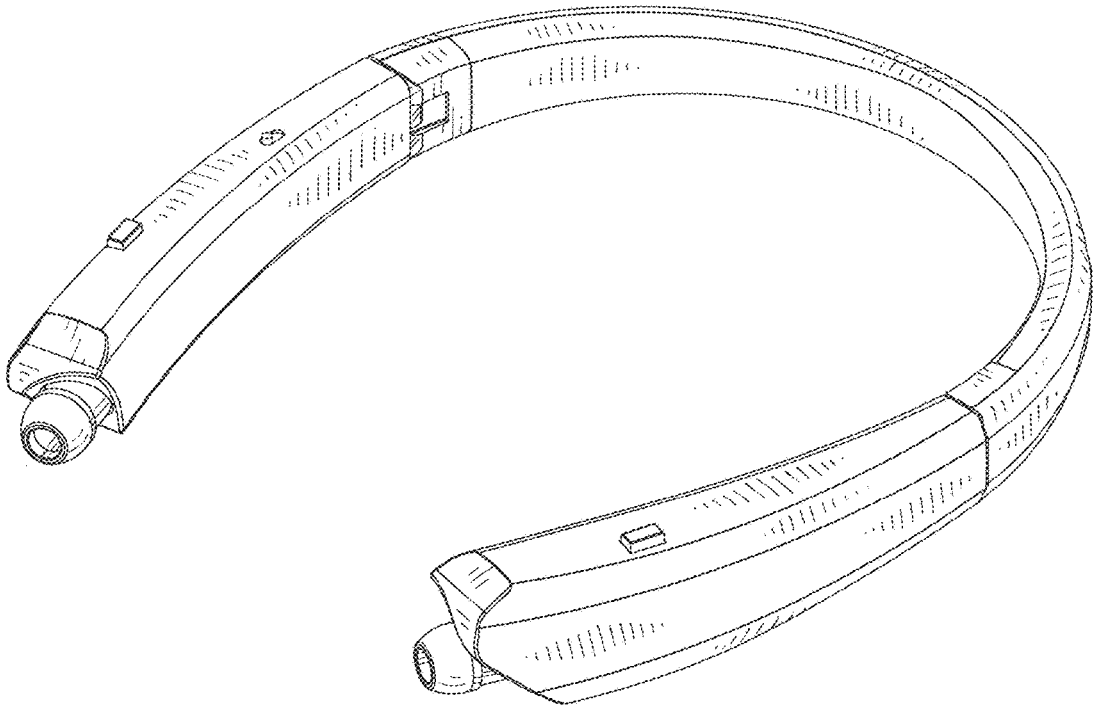

Fig.1

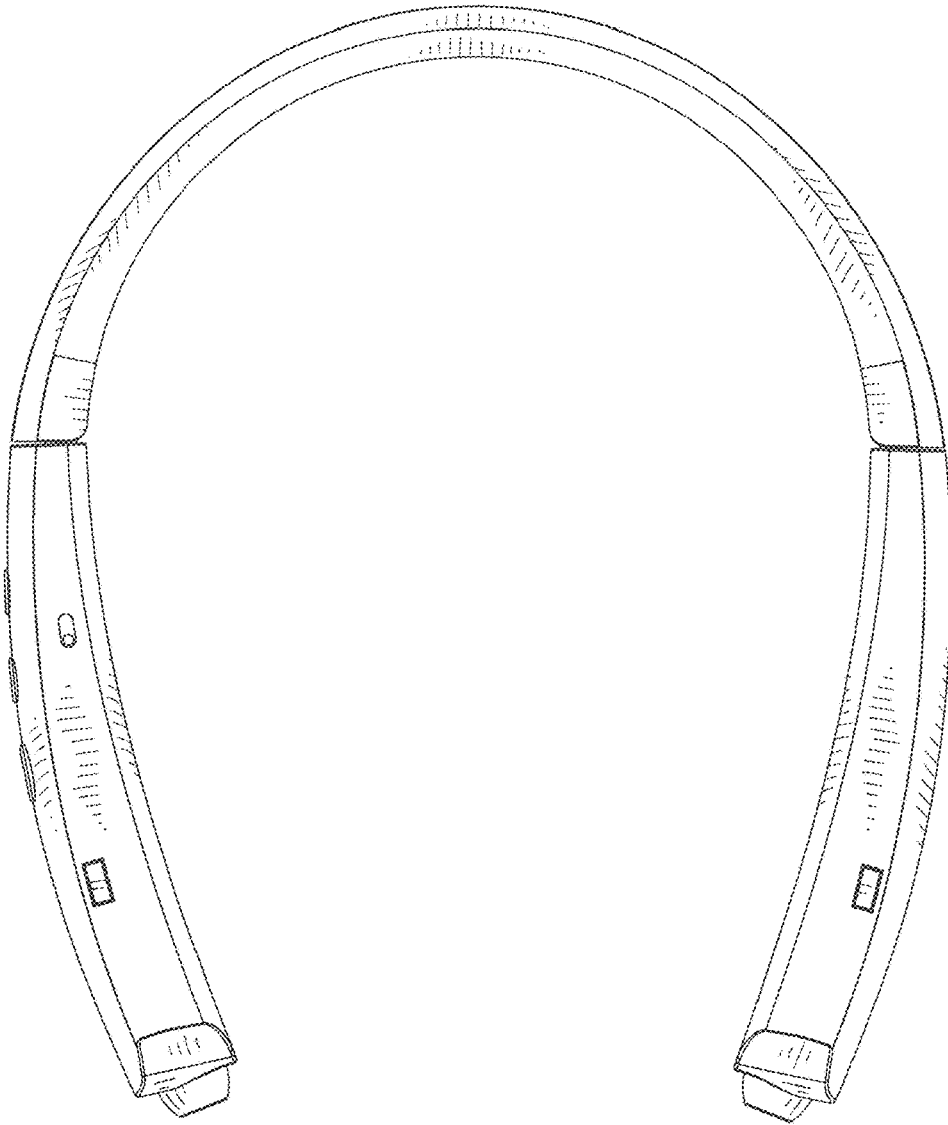

Fig.2

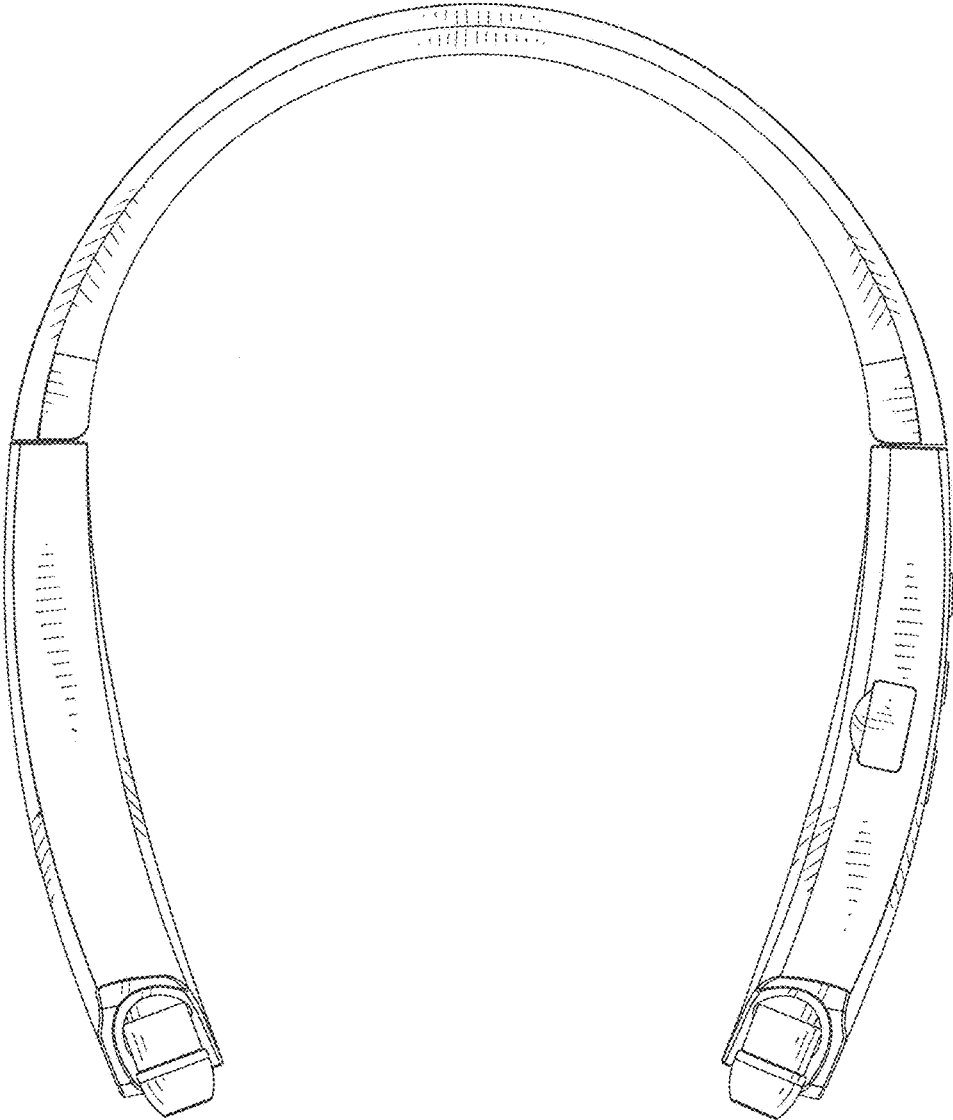

Fig.3

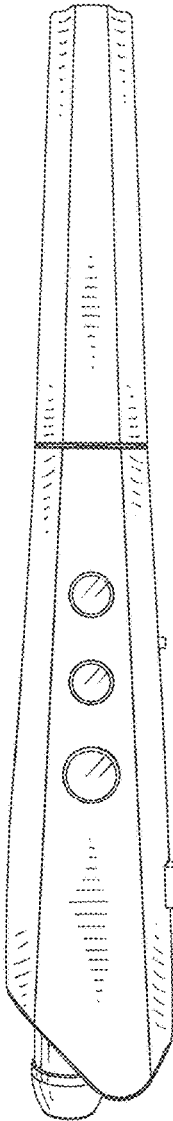

Fig.4

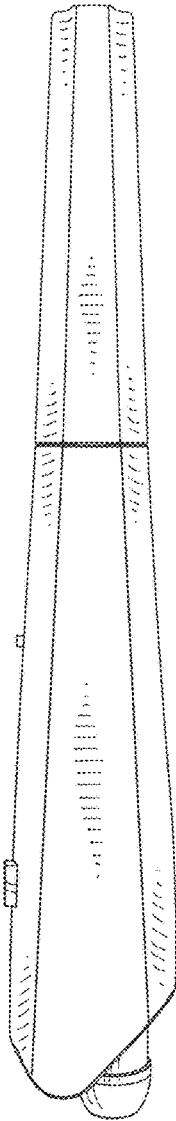

Fig.5

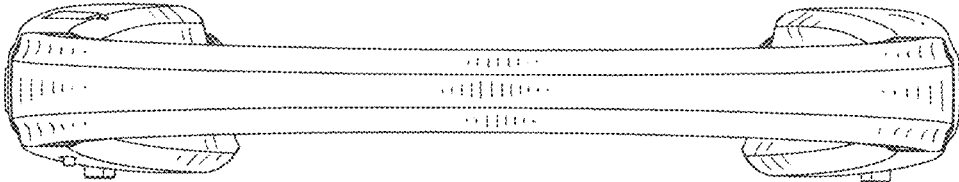

Fig.6

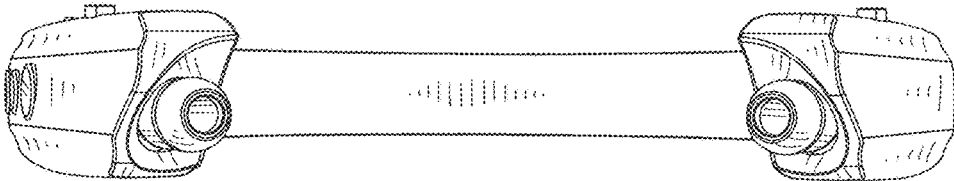

Fig.7

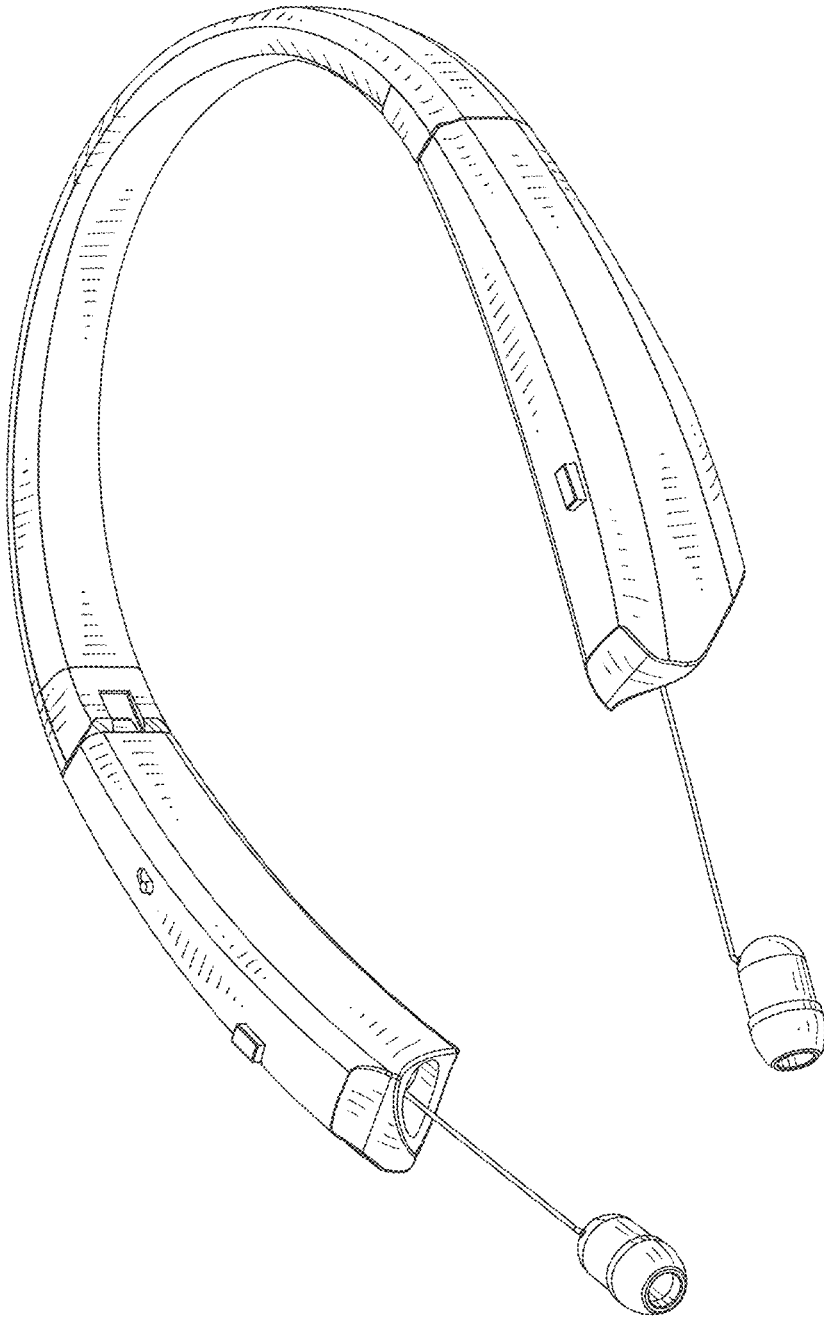

Fig. 8

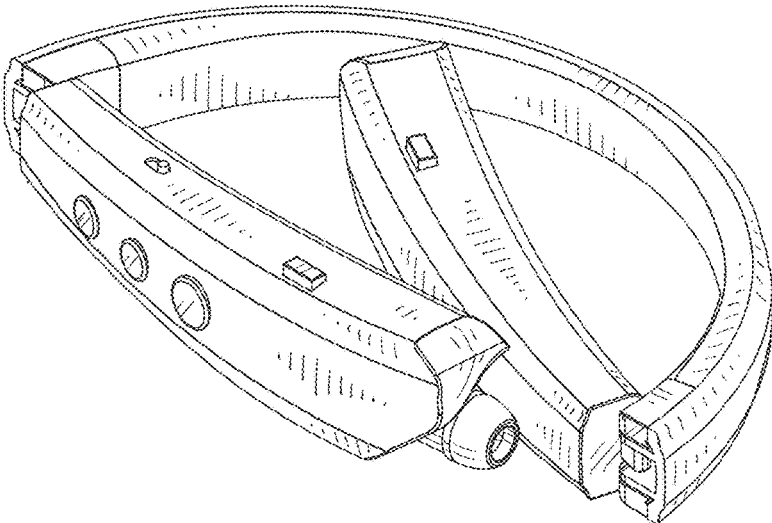

Fig.9