



US00D736763S

(12) **United States Design Patent**
Yum et al.

(10) **Patent No.:** **US D736,763 S**

(45) **Date of Patent:** **** Aug. 18, 2015**

(54) **PORTABLE COMPUTER**

(71) Applicant: **Samsung Electronics Co., Ltd.**,
Suwon-Si, Gyeonggi-do (KR)

(72) Inventors: **Sung-Jin Yum**, Seoul (KR); **Yeo-Wan Yun**, Seongnam (KR); **Ji-Sang Park**,
Yongin (KR)

(73) Assignee: **Samsung Electronics Co., Ltd.**,
Suwon-Si (KR)

(**) Term: **14 Years**

(21) Appl. No.: **29/452,587**

(22) Filed: **Apr. 18, 2013**

(30) **Foreign Application Priority Data**

Nov. 6, 2012 (KR) 30-2012-0052952

(51) **LOC (10) Cl.** **14-02**

(52) **U.S. Cl.**
USPC **D14/341**

(58) **Field of Classification Search**

USPC D14/341-347, 137, 138 R, 138 AA,
D14/138 C, 138 G, 496, 203.1, 203.3, 203.4,
D14/203.7, 129, 130, 147, 218, 247, 248,
D14/250, 374, 385, 388, 389, 315-318, 420,
D14/426, 439; D10/65, 104.1; D21/324,
D21/329, 330, 332; 455/556.1, 556.2, 566,
455/575.1, 90.3; 379/433.04, 433.01,
379/433.06, 916; 345/173, 901, 905;
361/679.26, 679.27, 679.3, 679.55,
361/679.56; D6/308, 310; 463/37;
248/917-924; 348/376; D19/26, 59-60
CPC A63H 33/3016; G06F 1/1613; H04M
1/0202; H04M 1/0279; H04M 1/0281;
H04M 1/0283

See application file for complete search history.

(56) **References Cited**

U.S. PATENT DOCUMENTS

D270,061 S 8/1983 Ackeret
D284,084 S 6/1986 Ferrara, Jr.

(Continued)

FOREIGN PATENT DOCUMENTS

KR 3005506890000 1/2010
KR 3005544080000 2/2010

(Continued)

OTHER PUBLICATIONS

U.S. Design Patent Application No. 29/405,537 Applicant: Ik-Sang Kim, et al., filed Nov. 3, 2011 entitled Tablet Computer.

(Continued)

Primary Examiner — Barbara Fox

Assistant Examiner — Dana K Weiland

(74) *Attorney, Agent, or Firm* — Wood, Herron & Evans, LLP

(57) **CLAIM**

The ornamental design for a portable computer, as shown and described.

DESCRIPTION

FIG. 1 is a top front perspective view of a portable computer showing our new design;
FIG. 2 is a front elevational view thereof;
FIG. 3 is a rear elevational view thereof;
FIG. 4 is a left side elevational view thereof;
FIG. 5 is a right side elevational view thereof;
FIG. 6 is a top plan view thereof;
FIG. 7 is a bottom plan view thereof; and,
FIG. 8 is a top front perspective view thereof when the present tablet computer is combined with a separate keyboard.
The broken lines shown on the portable computer represent portions of the portable computer which form no part of the claim. The broken lines showing a separate keyboard in FIG. 8 represent environment and forms no part of the claimed design. The front surface of the tablet computer is transparent and thus the large rectangle on the front of the portable computer is seen through.

1 Claim, 5 Drawing Sheets

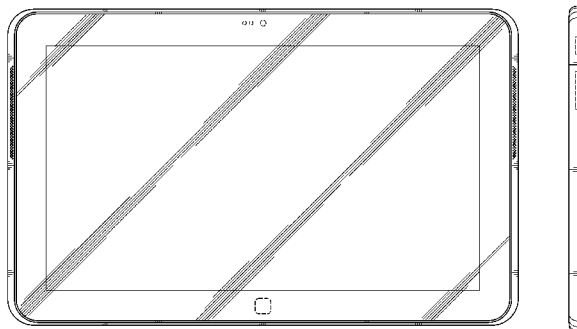

(56)

References Cited

U.S. PATENT DOCUMENTS

D306,583 S	3/1990	Krolopp et al.	D640,220 S	6/2011	Shyu et al.
D333,574 S	3/1993	Ackeret	D640,255 S	6/2011	Lee et al.
D337,569 S	7/1993	Kando	D641,018 S	7/2011	Lee et al.
5,267,123 A	11/1993	Boothroyd et al.	7,986,983 B2	7/2011	Harmon et al.
5,887,723 A	3/1999	Myles et al.	D645,465 S	9/2011	Lin et al.
D416,238 S	11/1999	Irie et al.	D645,833 S	9/2011	Seflic et al.
6,067,224 A	5/2000	Nobuchi	D646,902 S	10/2011	Woo et al.
6,259,597 B1	7/2001	Anzai et al.	D650,381 S	12/2011	Park et al.
D460,759 S	7/2002	West et al.	D651,206 S	12/2011	Kim et al.
D463,797 S	10/2002	Andre et al.	D651,597 S	1/2012	Lee et al.
6,519,139 B2	2/2003	Kambayashi	D651,598 S	1/2012	Kim et al.
D490,420 S	5/2004	Solomon et al.	D651,599 S	1/2012	Kim et al.
6,775,129 B1	8/2004	Ghosh et al.	D651,600 S	1/2012	Lee et al.
6,781,819 B2	8/2004	Yang et al.	D652,415 S	1/2012	Lee et al.
6,785,128 B1	8/2004	Yun	D652,416 S	1/2012	Park et al.
D499,704 S	12/2004	Song	D652,417 S	1/2012	Lee et al.
6,829,140 B2	12/2004	Shimano et al.	D652,831 S	1/2012	Lee et al.
D500,991 S	1/2005	Niitsu	D654,073 S	2/2012	Li
D504,889 S	5/2005	Andre et al.	D654,468 S	2/2012	Duan et al.
D517,545 S	3/2006	Buckel et al.	D654,498 S	2/2012	Hwang et al.
D532,791 S	11/2006	Kim	D654,893 S	2/2012	Jung
D540,790 S	4/2007	Kim et al.	D657,785 S	4/2012	Lee et al.
D558,460 S	1/2008	Yu et al.	D658,173 S	4/2012	Kim
D563,804 S	3/2008	Kimura et al.	D659,692 S	5/2012	Jung et al.
D564,511 S	3/2008	Akhtar	D661,294 S	6/2012	Park et al.
D579,930 S	11/2008	Maskatia	D661,295 S	6/2012	Park et al.
D584,738 S	1/2009	Kim et al.	D661,298 S	6/2012	Park et al.
D587,710 S	3/2009	Han	D661,299 S	6/2012	Kim et al.
D588,126 S	3/2009	Chiang et al.	D661,300 S	6/2012	Kim et al.
D589,511 S	3/2009	Han	D661,301 S	6/2012	Kim et al.
D589,958 S	4/2009	Han	D661,302 S	6/2012	Fukasawa et al.
D590,374 S	4/2009	Madonna et al.	D663,281 S	7/2012	Hwang
D592,212 S	5/2009	Hamada et al.	D663,298 S	7/2012	Song et al.
D592,214 S	5/2009	Bradford	D664,532 S	7/2012	Lee
7,542,284 B1	6/2009	Wilson, Sr.	D664,533 S	7/2012	Lee et al.
D601,138 S	9/2009	Solomon et al.	D664,534 S	7/2012	Lee et al.
D602,014 S	10/2009	Andre et al.	D664,535 S	7/2012	Lee et al.
D602,487 S	10/2009	Maskatia	D664,540 S	7/2012	Kim et al.
D604,291 S	11/2009	Andre et al.	D664,954 S	8/2012	Kim et al.
D605,626 S	12/2009	Park	D664,955 S	8/2012	Kim et al.
D606,539 S	12/2009	Liao et al.	D666,198 S	8/2012	Van Den Nieuwenhuizen et al.
D606,961 S	12/2009	Aarras	D667,396 S	* 9/2012	Koh D14/341
D610,582 S	2/2010	Sugitani et al.	D667,397 S	* 9/2012	Koh D14/341
D611,364 S	3/2010	Lenz et al.	D667,398 S	9/2012	Koh
D613,510 S	4/2010	Tzeng et al.	D667,399 S	9/2012	Koh
D613,951 S	4/2010	Tang et al.	D667,825 S	9/2012	Jung
D613,961 S	4/2010	Lin	D668,650 S	10/2012	Han
D616,440 S	5/2010	Lee	D668,651 S	* 10/2012	Kim et al. D14/341
D616,886 S	6/2010	Andre et al.	D669,070 S	10/2012	Hsu et al.
D617,793 S	6/2010	Chiang et al.	D669,468 S	10/2012	Akana et al.
D622,270 S	8/2010	Andre et al.	D669,469 S	10/2012	Kang
D624,914 S	10/2010	Wang	D670,286 S	11/2012	Akana et al.
D625,306 S	10/2010	Miyawaki	D670,692 S	11/2012	Akana et al.
D626,124 S	10/2010	Chyan et al.	D671,111 S	11/2012	Kim et al.
D626,437 S	11/2010	Lee et al.	D671,514 S	11/2012	Kim et al.
D627,667 S	11/2010	Lenz et al.	D671,536 S	11/2012	Fukasawa et al.
D628,913 S	12/2010	Cheng	D671,538 S	11/2012	Kim et al.
D629,771 S	12/2010	Haspil et al.	D671,539 S	11/2012	Kim et al.
D629,799 S	12/2010	Andre et al.	D672,344 S	12/2012	Li
D630,636 S	1/2011	Jeon et al.	D672,345 S	12/2012	Li
D631,455 S	1/2011	Kim et al.	D672,768 S	12/2012	Huang et al.
D631,469 S	1/2011	Demskie et al.	D673,561 S	1/2013	Hyun et al.
D633,498 S	3/2011	Andre et al.	D673,950 S	1/2013	Li et al.
D634,318 S	3/2011	Buckle et al.	D674,384 S	1/2013	Zhang
D634,745 S	3/2011	Park et al.	D675,203 S	1/2013	Yang
7,916,889 B2	3/2011	Takakusaki	D676,538 S	2/2013	Fehring
D636,391 S	4/2011	Shen et al.	D677,181 S	3/2013	Lenz et al.
D636,769 S	4/2011	Wood et al.	D677,255 S	3/2013	McManigal et al.
D636,770 S	4/2011	Li	D677,660 S	3/2013	Groene et al.
D638,392 S	5/2011	Price et al.	D678,271 S	3/2013	Chiu
D638,412 S	5/2011	Lee	D680,533 S	4/2013	Song et al.
D639,226 S	6/2011	Juergens et al.	D682,264 S	5/2013	Kim et al.
D639,804 S	6/2011	Hwang et al.	D682,821 S	5/2013	Kim et al.
D639,805 S	6/2011	Song et al.	D682,822 S	5/2013	Kim et al.
D639,806 S	6/2011	Lee et al.	D682,823 S	5/2013	Park et al.
			D682,824 S	5/2013	Kim et al.
			D682,825 S	5/2013	Kim et al.
			D682,826 S	5/2013	Kim et al.
			D682,827 S	5/2013	Park et al.

(56)

References Cited

U.S. PATENT DOCUMENTS

D682,828	S	5/2013	Kim et al.	
D686,202	S	7/2013	Lee et al.	
D686,203	S	7/2013	Lee et al.	
D687,032	S *	7/2013	Sanjo et al.	D14/341
D689,481	S *	9/2013	Song et al.	D14/341
D692,880	S *	11/2013	Song et al.	D14/341
D695,249	S *	12/2013	Kim et al.	D14/138 G
D695,250	S *	12/2013	Kim et al.	D14/138 G
D695,737	S *	12/2013	Kim et al.	D14/341
D696,249	S *	12/2013	Lee	D14/341
D696,662	S *	12/2013	Song et al.	D14/341
D698,780	S *	2/2014	Lee	D14/341
D702,228	S *	4/2014	Park	D14/341
D702,229	S *	4/2014	Lim et al.	D14/341
D702,233	S *	4/2014	Lee et al.	D14/341
D706,774	S *	6/2014	Park et al.	D14/341
D710,844	S *	8/2014	Lee et al.	D14/341
D712,402	S *	9/2014	Park et al.	D14/341
D712,403	S *	9/2014	Park et al.	D14/341
D712,899	S *	9/2014	Park et al.	D14/341
D714,287	S *	9/2014	Takahashi et al.	D14/341
2003/0048595	A1	3/2003	Hsieh et al.	
2003/0151888	A1	8/2003	Chien et al.	
2005/0018396	A1	1/2005	Nakajima et al.	
2005/0041378	A1	2/2005	Hamada et al.	
2009/0231292	A1	9/2009	Hsieh et al.	
2011/0074740	A1	3/2011	Liu	
2011/0294555	A1	12/2011	Happonen et al.	
2012/0092195	A1	4/2012	Lin	

FOREIGN PATENT DOCUMENTS

KR	3005639120000	6/2010
KR	3005639130000	6/2010
KR	3005680110000	7/2010
KR	3005804720000	11/2010
KR	3005869900000	1/2011
KR	3005942330000	3/2011
KR	3005958550000	4/2011
KR	3005985190000	5/2011
KR	3005994750000	5/2011
KR	3006004150000	5/2011
KR	3006004300000	5/2011
KR	3006013110001	6/2011
KR	3006013130000	6/2011
KR	3006013160000	6/2011
KR	3006013170000	6/2011
KR	3006046440000	7/2011
KR	3006052790000	7/2011
KR	3006052810000	7/2011
KR	3006052820000	7/2011
KR	3006052830000	7/2011
KR	3006059710000	7/2011
KR	3006063210000	7/2011
KR	3006064090000	7/2011
KR	3006083610000	8/2011
KR	3006083630000	8/2011
KR	3006083640000	8/2011
KR	3006083650000	8/2011
KR	3006083710000	8/2011
KR	3006083730000	8/2011
KR	3006085180000	8/2011

OTHER PUBLICATIONS

Design U.S. Appl. No. 29/407,975 Applicant: Bum-Ho Chun, et al., filed Dec. 6, 2011 entitled Tablet Computer.
 Design U.S. Appl. No. 29/407,982 Applicant: EunuaeShally Lee, et al., filed Dec. 6, 2011 entitled Tablet Computer.
 Design U.S. Appl. No. 29/407,984 Applicant: So-Yoon Jeon, et al., filed Dec. 6, 2011 entitled Tablet Computer.
 Design U.S. Appl. No. 29/408,017 Applicant: Jae-Seung Song, et al., filed Dec. 6, 2011 entitled Tablet Computer.
 Design U.S. Appl. No. 29/416,029 Applicant: Min-Jung Kim, et al., filed Mar. 16, 2012 entitled Tablet Computer.

Design U.S. Appl. No. 29/416,032 Applicant: Min-Jung Kim, et al., filed Mar. 16, 2012 entitled Tablet Computer.
 Design U.S. Appl. No. 29/418,670 Applicant: Byeong-Yong Song, et al., filed Apr. 19, 2012 entitled Tablet Computer.
 Design U.S. Appl. No. 29/419,893 Applicant: Ik-Sang Kim, et al., filed May 2, 2012 entitled Slate Computer.
 Design U.S. Appl. No. 29/419,907 Applicant: Ik-Sang Kim, et al., filed May 2, 2012 entitled Slate Computer.
 Design U.S. Appl. No. 29/419,911 Applicant: Min-Jung Kim, et al., filed May 2, 2012 entitled Tablet Computer.
 Design U.S. Appl. No. 29/420,669 Applicant: Woo-Teik Lim, et al., filed May 11, 2012 entitled Tablet Computer.
 Design U.S. Appl. No. 29/422,581 Applicant: Jung-Hyun Park, et al., filed May 22, 2012 entitled Notebook Computer.
 Design U.S. Appl. No. 29/422,594 Applicant: Jung-Hyun Park, et al., filed May 22, 2012 entitled Notebook Computer.
 Design U.S. Appl. No. 29/422,779 Applicant: Tak-Yun Kim, et al., filed May 23, 2012 entitled Notebook Computer.
 Design U.S. Appl. No. 29/424,453 Applicant: Se-O Lee, et al., filed Jun. 12, 2012 entitled Notebook Computer.
 Design U.S. Appl. No. 29/424,462 Applicant: Sang-Eun Lee, et al., filed Jun. 12, 2012 entitled Notebook Computer.
 Design U.S. Appl. No. 29/425,225 Applicant: Seung-Ho Jung, et al., filed Jun. 20, 2012 entitled Portable Computer.
 Design U.S. Appl. No. 29/425,732 Applicant: Ji-Sang Park, et al., filed Jun. 26, 2012 entitled Portable Computer.
 Design U.S. Appl. No. 29/425,977 Applicant: Ji-Sang Park, et al., filed Jun. 28, 2012 entitled Tablet Computer.
 Design U.S. Appl. No. 29/425,978 Applicant: Woo-Teik Lim, et al., filed Jun. 28, 2012 entitled Tablet Computer.
 Design U.S. Appl. No. 29/427,736 Applicant: Min-Jung Kim, et al., filed Jul. 21, 2012 entitled Tablet Computer.
 Design U.S. Appl. No. 29/431,774 Applicant: Sang-Eun Lee, et al., filed Sep. 11, 2012 entitled Tablet Computer.
 Design U.S. Appl. No. 29/435,870 Inventor: Son-Young Lee, et al., filed Oct. 30, 2012 entitled Portable Computer.
 Design U.S. Appl. No. 29/435,889 Inventor: Dong-Seok Lee, et al., filed Oct. 30, 2012 entitled Portable Computer.
 Design U.S. Appl. No. 29/438,934 Inventor: Ik-Sang Kim, et al., filed Dec. 5, 2012 entitled Slate Computer.
 Design U.S. Appl. No. 29/438,948 Inventor: Chung-Ha Kim, et al., filed Dec. 5, 2012 entitled Portable Computer.
 Design U.S. Appl. No. 29/438,951 Inventor: Chung-Ha Kim, et al., filed Dec. 5, 2012 entitled Portable Computer.
 Design U.S. Appl. No. 29/441,093 Inventor: Chang-Ho Lee, et al., filed Dec. 31, 2012 entitled Portable Computer.
 Design U.S. Appl. No. 29/441,101 Inventor: Chang-Ho Lee, et al., filed Dec. 31, 2012 entitled Portable Computer.
 Design U.S. Appl. No. 29/441,112 Inventor: Chang-Ho Lee, et al., filed Dec. 31, 2012 entitled Portable Computer.
 Design U.S. Appl. No. 29/441,114 Inventor: Chang-Ho Lee, et al., filed Dec. 31, 2012 entitled Portable Computer.
 Design U.S. Appl. No. 29/441,179 Inventor: Chang-Ho Lee, et al., filed Jan. 2, 2013 entitled Portable Computer.
 Design U.S. Appl. No. 29/452,297 Inventor: Min-Hee Lee, et al., filed Apr. 15, 2013 entitled Notebook Computer.
 Design U.S. Appl. No. 29/452,583 Inventor: Seung-Ho Jung, et al., filed Apr. 18, 2013 entitled Portable Computer.
 Design U.S. Appl. No. 29/452,586 Inventor: Seung-Ho Jung, et al., filed Apr. 18, 2013 entitled Portable Computer.
 Design U.S. Appl. No. 29/452,588 Inventor: Chung-Ha Kim, et al., filed Apr. 18, 2013 entitled Portable Computer.
 Design U.S. Appl. No. 29/452,592 Inventor: Son-Young Lee, et al., filed Apr. 18, 2013 entitled Portable Computer.
 Design U.S. Appl. No. 29/452,593 Inventor: Woo-Teik Lim, et al., filed Apr. 18, 2013 entitled Slate Computer.
 Design U.S. Appl. No. 29/452,594 Inventor: Son-Young Lee, et al., filed Apr. 18, 2013 entitled Portable Computer.
 Design U.S. Appl. No. 29/452,595 Inventor: Ho-Young Seoc, et al., filed Apr. 18, 2013 entitled Slate Computer.
 Design U.S. Appl. No. 29/452,601 Inventor: Ji-Sang Park, et al., filed Apr. 18, 2013 entitled Portable Computer.

(56)

References Cited

OTHER PUBLICATIONS

Design U.S. Appl. No. 29/456,501 Inventor: Se-Hun Oh, et al., filed May 31, 2013 entitled Portable Computer.
Design U.S. Appl. No. 29/457,839 Inventor: Son-Young Lee, et al., filed Jun. 13, 2013 entitled Portable Computer.
Design U.S. Appl. No. 29/457,846 Inventor: Son-Young Lee, et al., filed Jun. 13, 2013 entitled Body of Portable Computer.
Design U.S. Appl. No. 29/457,848 Inventor: Son-Young Lee, et al., filed Jun. 13, 2013 entitled Portable Computer.
Design U.S. Appl. No. 29/457,852 Inventor: Son-Young Lee, et al., filed Jun. 13, 2013 entitled Body of Portable Computer.
Design U.S. Appl. No. 29/457,859 Inventor: Son-Young Lee, et al., filed Jun. 13, 2013 entitled Portable Computer.
Design U.S. Appl. No. 29/457,864 Inventor: Son-Young Lee, et al., filed Jun. 13, 2013 entitled Portable Computer.
Design U.S. Appl. No. 29/457,867 Inventor: Son-Young Lee, et al., filed Jun. 13, 2013 entitled Portable Computer.
Design U.S. Appl. No. 29/457,870 Inventor: Son-Young Lee, et al., filed Jun. 13, 2013 entitled Body of Portable Computer.
Design U.S. Appl. No. 29/457,871 Inventor: Son-Young Lee, et al., filed Jun. 13, 2013 entitled Display for a Portable Computer.
Design U.S. Appl. No. 29/457,873 Inventor: Son-Young Lee, et al., filed Jun. 13, 2013 entitled Portable Computer.
Design U.S. Appl. No. 29/457,874 Inventor: Won-Suk Chung, et al., filed Jun. 13, 2013 entitled Body of Portable Computer.

Design U.S. Appl. No. 29/457,875 Inventor: Son-Young Lee, et al., filed Jun. 13, 2013 entitled Display for a Portable Computer.
Design U.S. Appl. No. 29/458,186 Inventor: Ji-Eun Myung, et al., filed Jun. 28, 2013 entitled Portable Computer.
Design U.S. Appl. No. 29/458,191 Inventor: Ji-Eun Myung, et al., filed Jun. 28, 2013 entitled Portable Computer.
Design U.S. Appl. No. 29/458,200 Inventor: Ji-Eun Myung, et al., filed Jun. 28, 2013 entitled Body of Portable Computer.
Design U.S. Appl. No. 29/458,204 Inventor: Ji-Eun Myung, et al., filed Jun. 28, 2013 entitled Portable Computer.
Design U.S. Appl. No. 29/458,206 Inventor: Ji-Eun Myung, et al., filed Jun. 28, 2013 entitled Body of Portable Computer.
Design U.S. Appl. No. 29/458,207 Inventor: Ji-Eun Myung, et al., filed Jun. 28, 2013 entitled Display for a Portable Computer.
Design U.S. Appl. No. 29/458,277 Inventor: Ji-Eun Myung, et al., filed Jun. 28, 2013 entitled Display for a Portable Computer.
Design U.S. Appl. No. 29/458,285 Inventor: Ji-Eun Myung, et al., filed Jun. 28, 2013 entitled Display for a Portable Computer.
Design U.S. Appl. No. 29/458,289 Inventor: Ji-Eun Myung, et al., filed Jun. 28, 2013 entitled Body of Portable Computer.
Design U.S. Appl. No. 29/458,290 Inventor: Ji-Eun Myung, et al., filed Jun. 28, 2013 entitled Display for a Portable Computer.
Design U.S. Appl. No. 29/452,596 Inventor: Son-Young Lee, et al., filed Apr. 18, 2013 entitled Portable Computer.

* cited by examiner

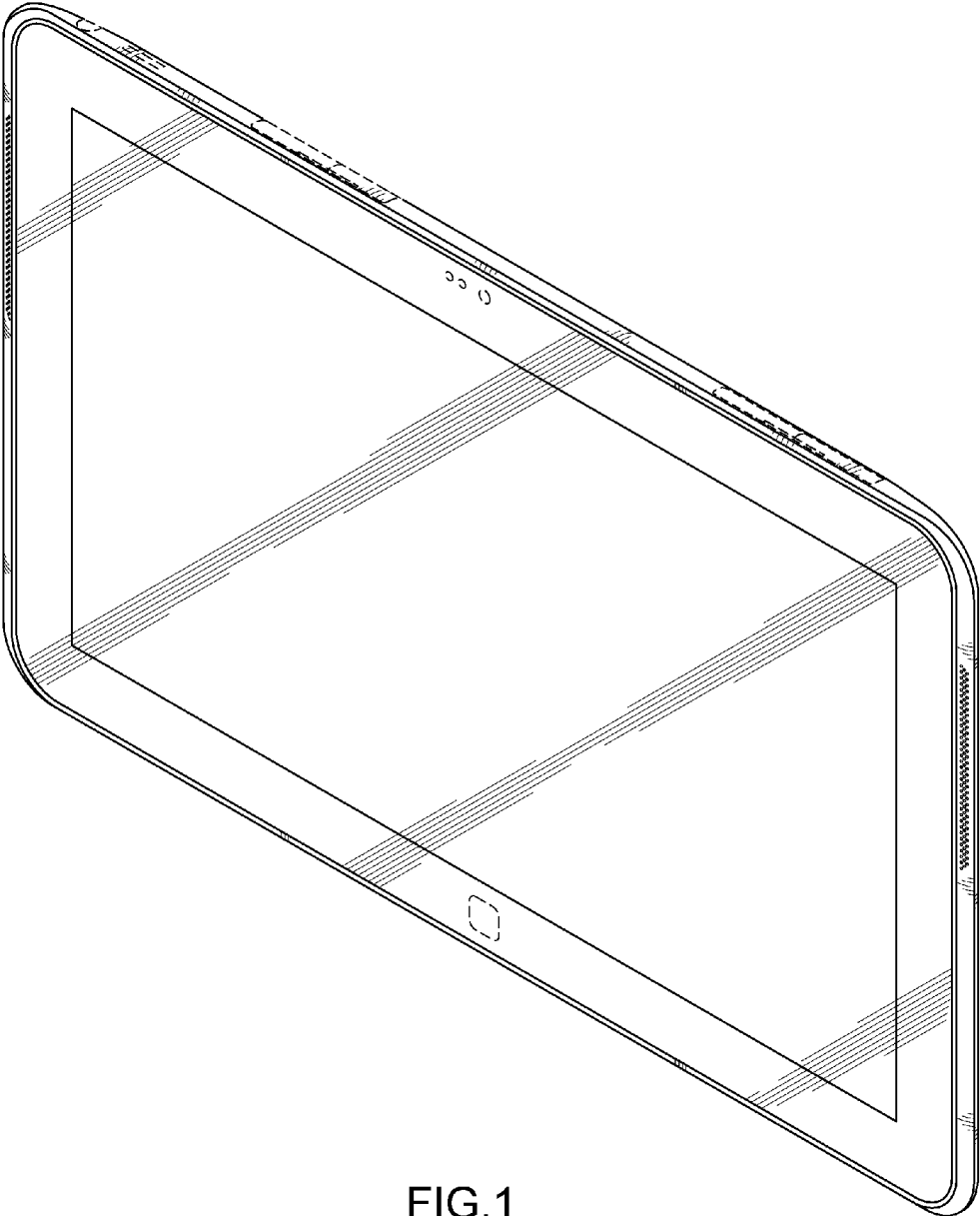

FIG.1

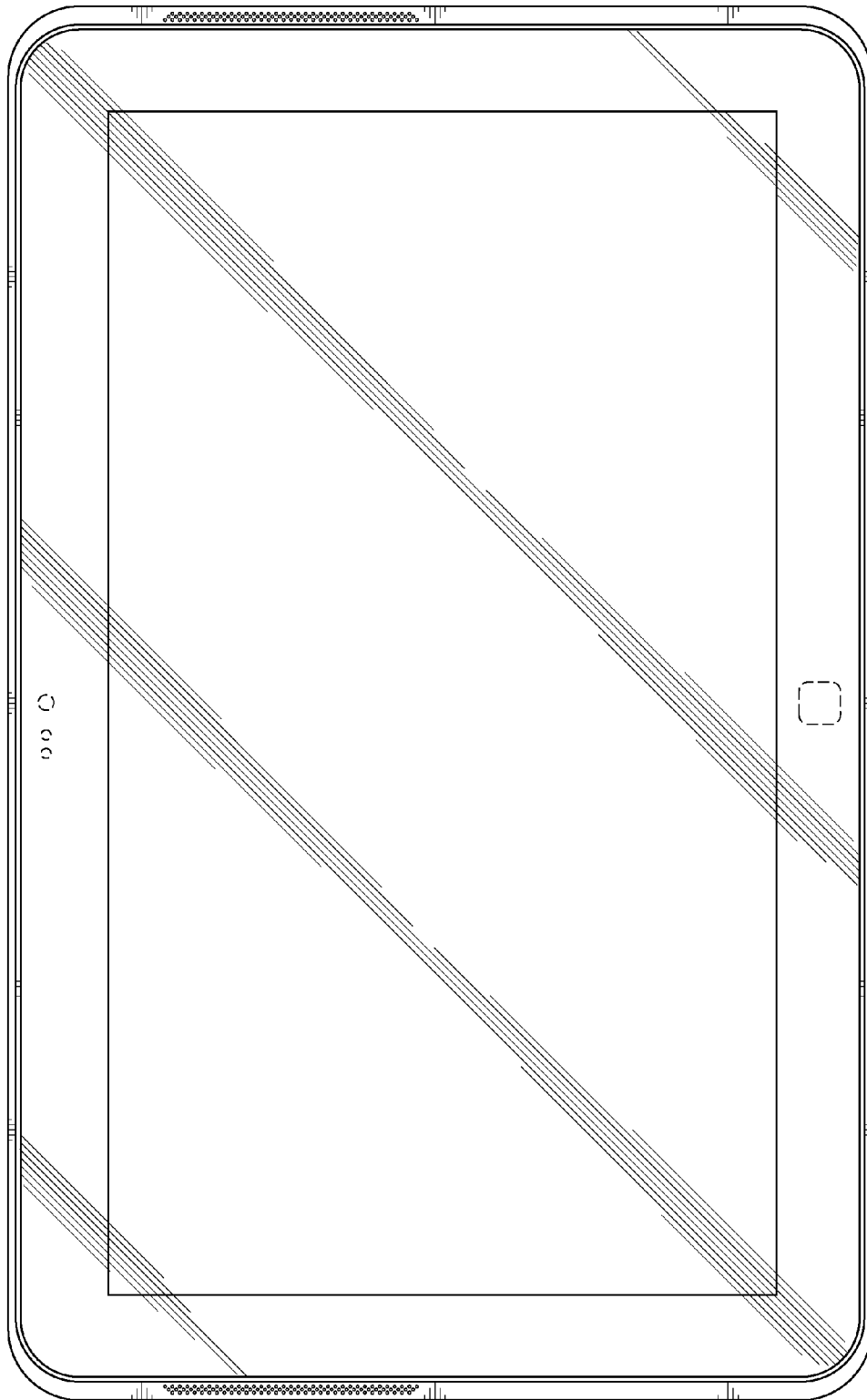

FIG.2

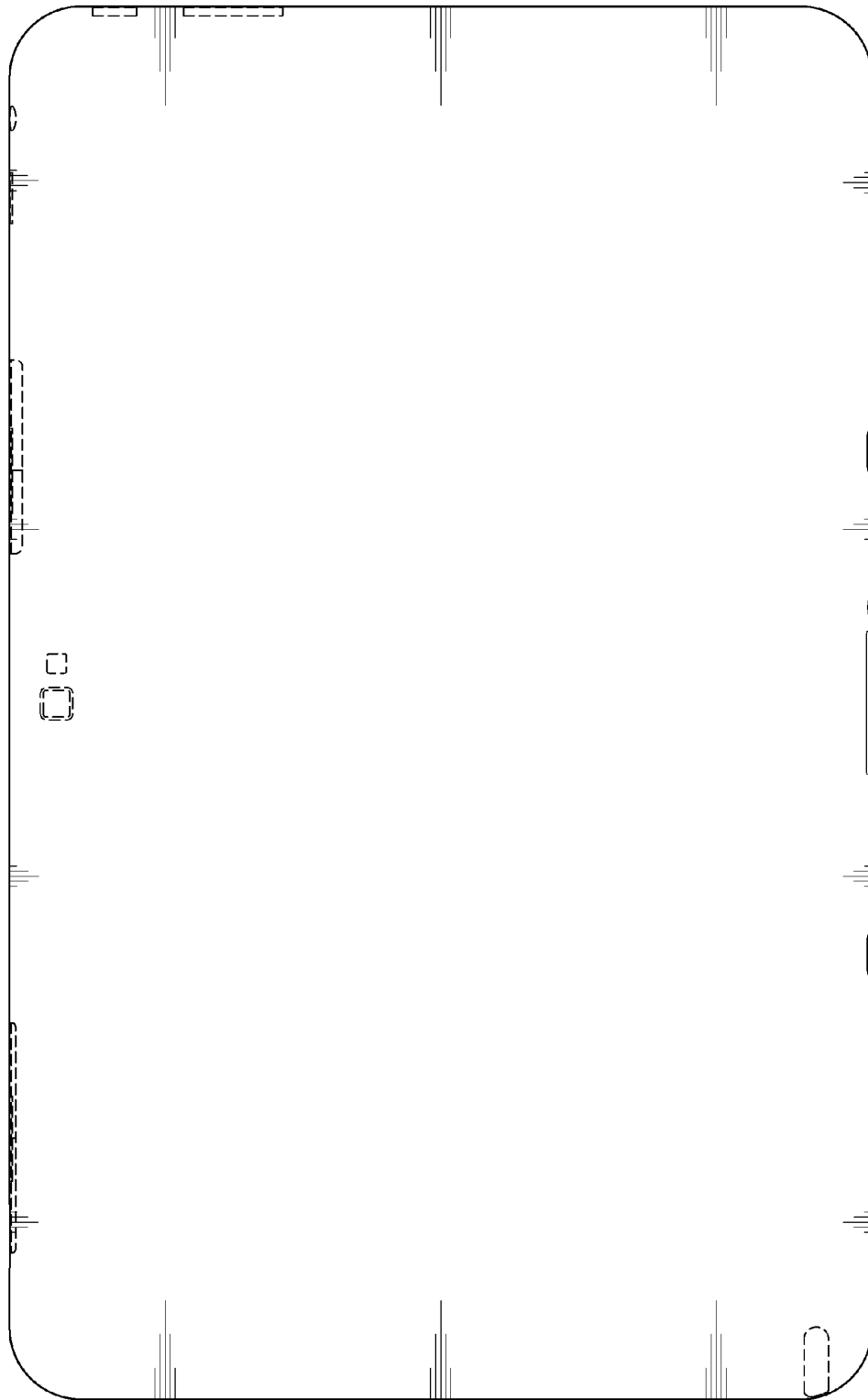

FIG.3

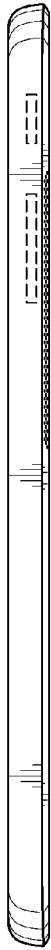

FIG. 4

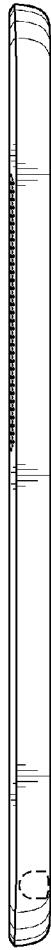

FIG. 5



FIG. 6

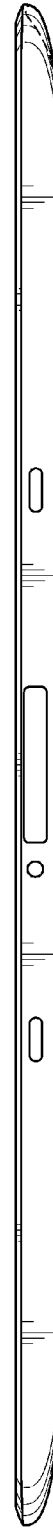

FIG. 7

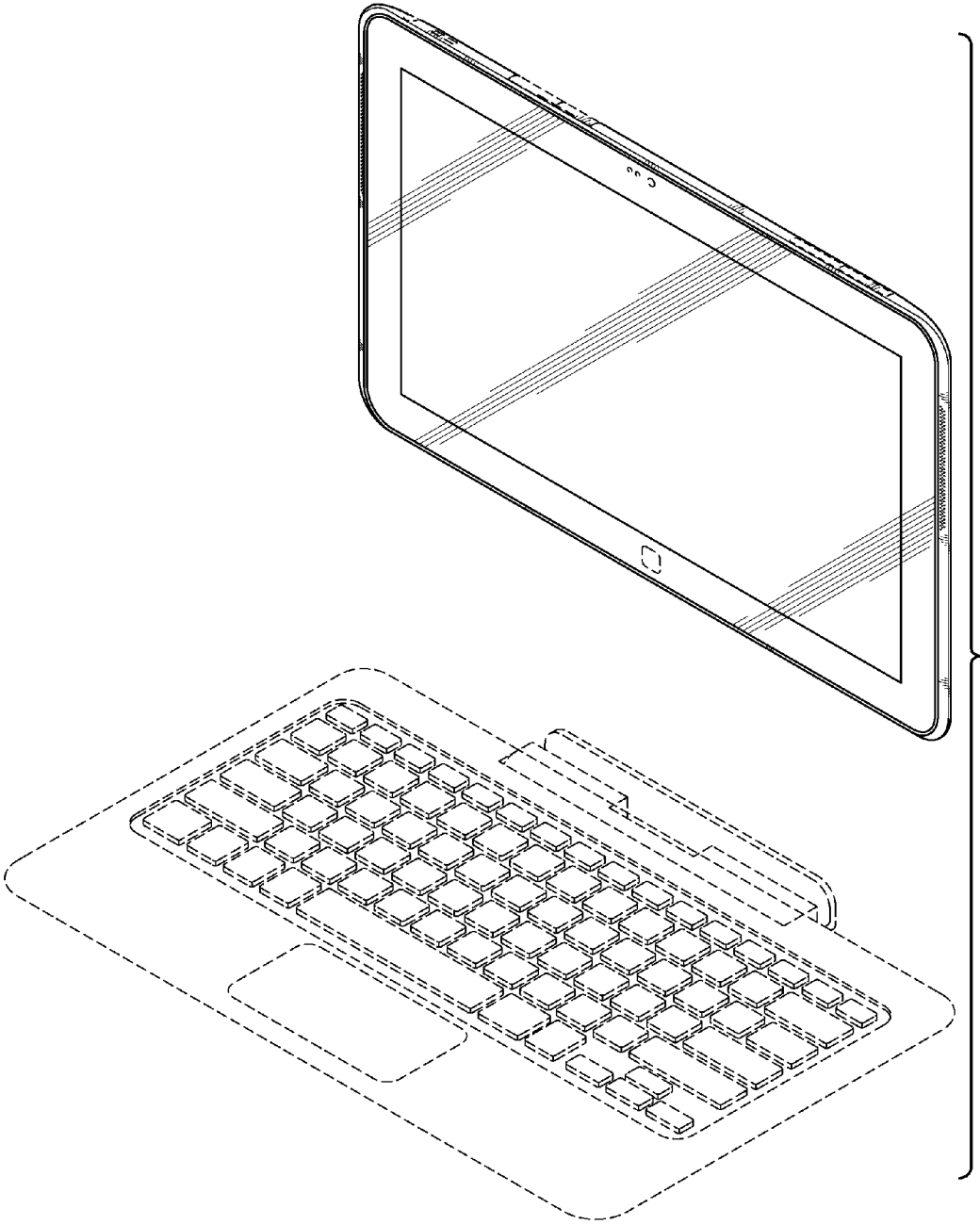

FIG.8