



US00D772468S

(12) **United States Design Patent**
Sonneman

(10) **Patent No.:** **US D772,468 S**

(45) **Date of Patent:** **** Nov. 22, 2016**

(54) **LIGHTING FIXTURE**

(71) Applicant: **Robert A. Sonneman**, Mamaroneck,
NY (US)

(72) Inventor: **Robert A. Sonneman**, Mamaroneck,
NY (US)

(**) Term: **15 Years**

(21) Appl. No.: **29/566,151**

(22) Filed: **May 27, 2016**

(51) **LOC (10) Cl.** **26-03**

(52) **U.S. Cl.**
USPC **D26/90**

(58) **Field of Classification Search**
USPC D26/81-91, 143, 144
CPC F21S 8/04; F21S 8/043; F21S 8/046;
F21S 8/06; F21S 8/061; F21S 8/063; F21S
8/065

See application file for complete search history.

(56) **References Cited**

U.S. PATENT DOCUMENTS

D49,788 S *	10/1916	Warren	D26/81
D202,997 S *	11/1965	Heifetz	D26/144
D317,058 S *	5/1991	Sonneman	D26/92
D320,465 S *	10/1991	Sonneman	D26/86
D373,002 S *	8/1996	Porter	D26/144
D373,213 S *	8/1996	Porter	D26/84
7,354,171 B2 *	4/2008	Pazula	F21V 21/02 362/135
D592,787 S *	5/2009	Chandler	D26/81
D604,886 S *	11/2009	Rugee	D26/81
D620,176 S *	7/2010	Sabernig	D26/143

D620,629 S *	7/2010	Sabernig	D26/84
D634,887 S *	3/2011	Kitts	D26/143
D649,276 S *	11/2011	Sabernig	D26/84
D649,277 S *	11/2011	Sabernig	D26/84
D649,675 S *	11/2011	Sabernig	D26/84
D657,486 S *	4/2012	Sabernig	D26/84
D657,487 S *	4/2012	Sabernig	D26/84
D666,760 S *	9/2012	Arola Ferrer	D26/84
D671,670 S *	11/2012	Sonneman	D26/90
D674,955 S *	1/2013	Sonneman	D26/88
D709,637 S *	7/2014	Terzani	D26/83
D722,402 S *	2/2015	Orozco	D26/88
2012/0257388 A1 *	10/2012	Bracher	F21S 8/061 362/249.01

* cited by examiner

Primary Examiner — Clare E Heflin

(74) *Attorney, Agent, or Firm* — Gottlieb, Rackman &
Reisman P.C.

(57) **CLAIM**

The ornamental design for a lighting fixture, as shown and described.

DESCRIPTION

FIG. 1 is a perspective view of the lighting fixture showing my new design;

FIG. 2 is a top plan view thereof;

FIG. 3 is a front elevational view thereof, the rear elevational view being a mirror image;

FIG. 4 is a right side elevational view thereof, the left side being a mirror image; and,

FIG. 5 is a bottom plan view thereof.

The broken lines in the drawings represent portions of the article that form no part of the claimed design.

1 Claim, 3 Drawing Sheets

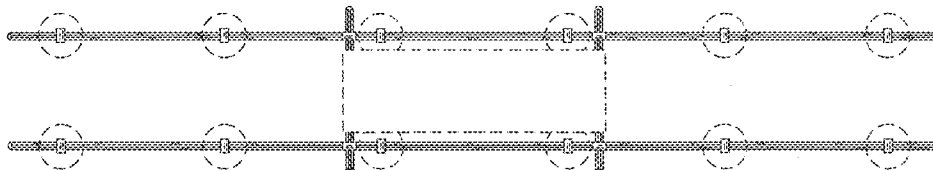
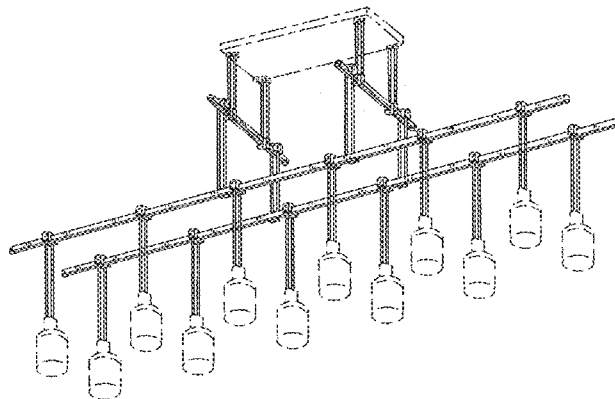

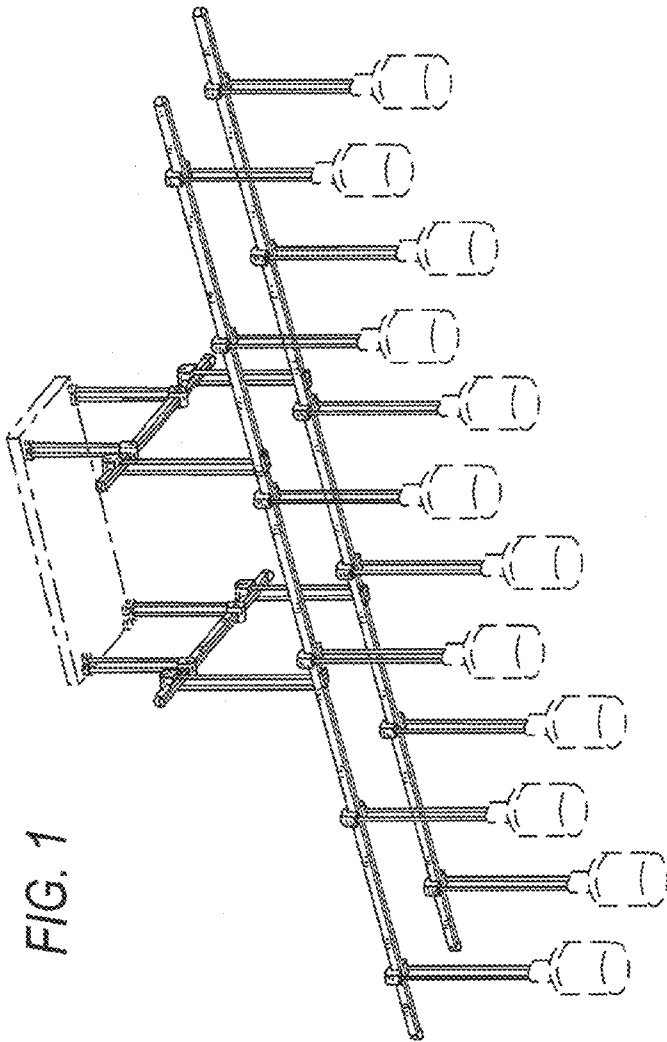

FIG. 1

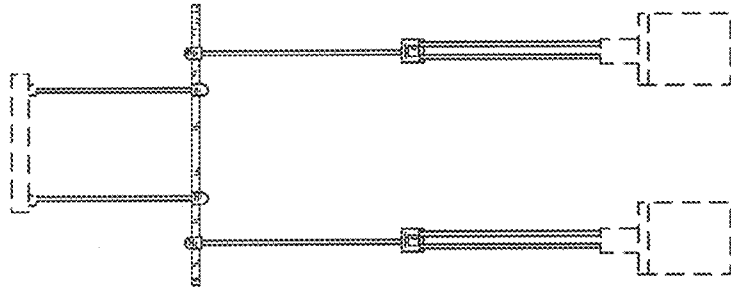

FIG. 4

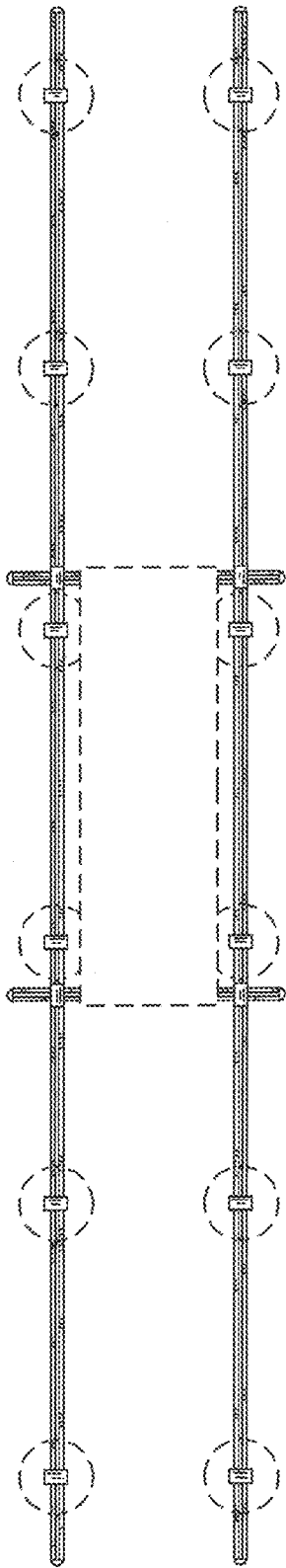

FIG. 2

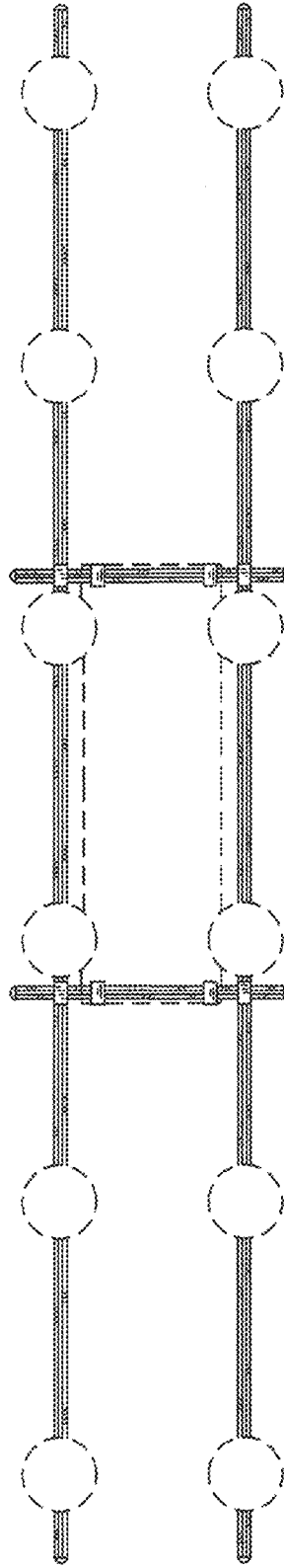

FIG. 5

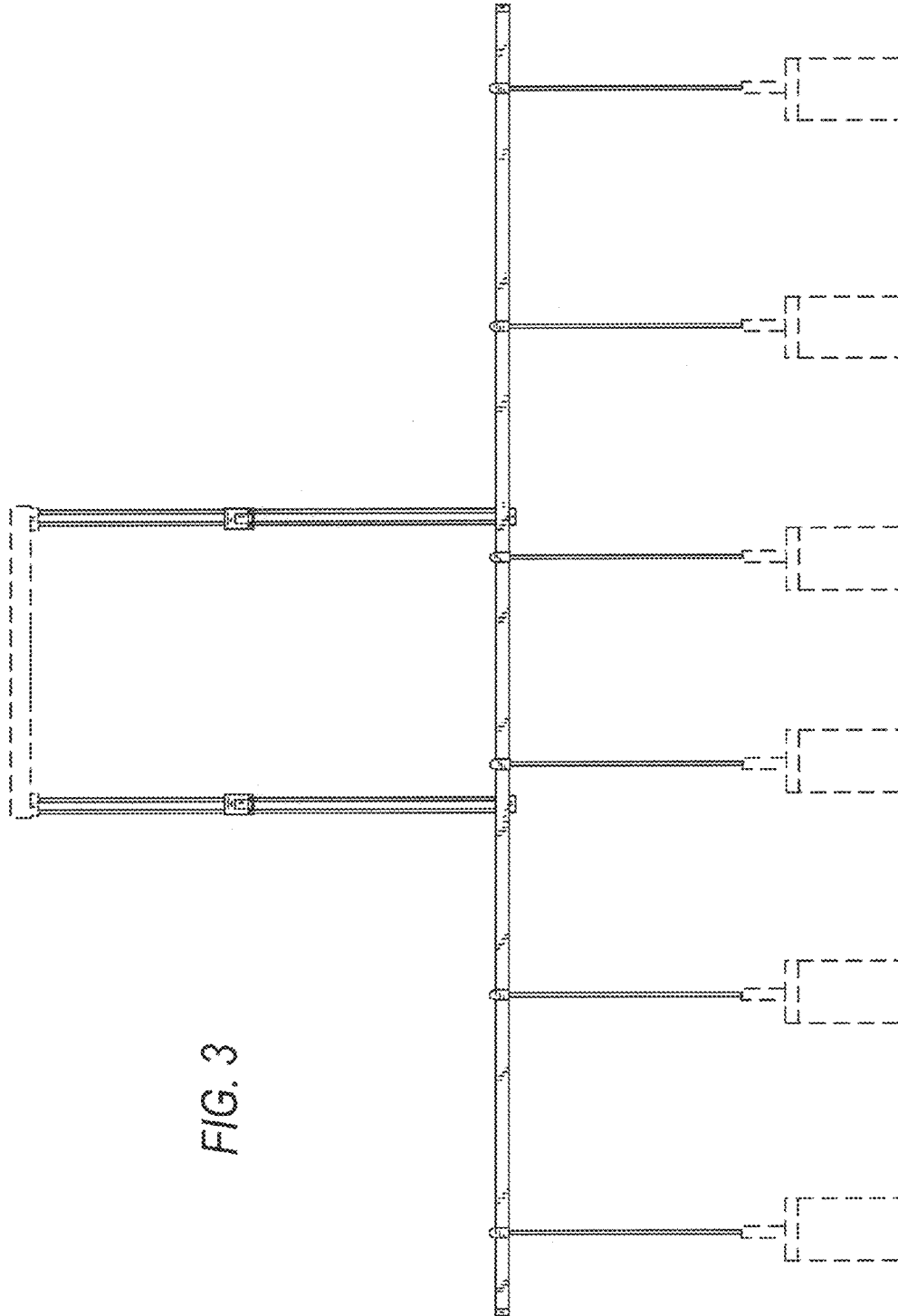

FIG. 3