

(19) World Intellectual Property Organization
International Bureau



(43) International Publication Date
5 April 2012 (05.04.2012)

(10) International Publication Number
WO 2012/044788 A2

(51) International Patent Classification:
G06F 3/048 (2006.01)

[CA/CA]; 2488 Oakhaven Drive, Oakville, Ontario L6M 4B9 (CA). **CASSAR, Ron** [CA/CA]; 165 Nicholson Court, Burlington, Ontario L7N 3N5 (CA).

(21) International Application Number:

PCT/US2011/053917

(74) Agent: **KNEPPER, Bradley, M.**; Sheridan Ross P.C., 1560 Broadway, Suite 1200, Denver, CO 80202 (US).

(22) International Filing Date:

29 September 2011 (29.09.2011)

(81) Designated States (unless otherwise indicated, for every kind of national protection available): AE, AG, AL, AM, AO, AT, AU, AZ, BA, BB, BG, BH, BR, BW, BY, BZ, CA, CH, CL, CN, CO, CR, CU, CZ, DE, DK, DM, DO, DZ, EC, EE, EG, ES, FI, GB, GD, GE, GH, GM, GT, HN, HR, HU, ID, IL, IN, IS, JP, KE, KG, KM, KN, KP, KR, KZ, LA, LC, LK, LR, LS, LT, LU, LY, MA, MD, ME, MG, MK, MN, MW, MX, MY, MZ, NA, NG, NI, NO, NZ, OM, PE, PG, PH, PL, PT, QA, RO, RS, RU, RW, SC, SD, SE, SG, SK, SL, SM, ST, SV, SY, TH, TJ, TM, TN, TR, TT, TZ, UA, UG, US, UZ, VC, VN, ZA, ZM, ZW.

(25) Filing Language:

English

(26) Publication Language:

English

(30) Priority Data:

61/389,087	1 October 2010 (01.10.2010)	US
61/389,117	1 October 2010 (01.10.2010)	US
61/389,000	1 October 2010 (01.10.2010)	US
61/458,150	17 November 2010 (17.11.2010)	US
61/539,884	27 September 2011 (27.09.2011)	US
13/247,739	28 September 2011 (28.09.2011)	US

(71) Applicant (for all designated States except US): **IMERJ LLC** [US/US]; 305 Interlocken Parkway, Broomfield, CO 80021 (US).

(84) Designated States (unless otherwise indicated, for every kind of regional protection available): ARIPO (BW, GH, GM, KE, LR, LS, MW, MZ, NA, RW, SD, SL, SZ, TZ, UG, ZM, ZW), Eurasian (AM, AZ, BY, KG, KZ, MD, RU, TJ, TM), European (AL, AT, BE, BG, CH, CY, CZ, DE, DK, EE, ES, FI, FR, GB, GR, HR, HU, IE, IS, IT, LT, LU, LV, MC, MK, MT, NL, NO, PL, PT, RO, RS,

(72) Inventors; and

(75) Inventors/Applicants (for US only): **SIRPAL, Sanjiv** [CA/CA]; 3264 Stocksbridge Avenue, Oakville, Ontario L6M 0E3 (CA). **GIMPL, Martin** [FI/FI]; Jussaarenkuja 5 C 32, FI-00840 Helsinki (FI). **SELIM, Mohammed**

[Continued on next page]

(54) Title: METHOD AND APPARATUS FOR MOVING DISPLAY DURING A DEVICE FLIP

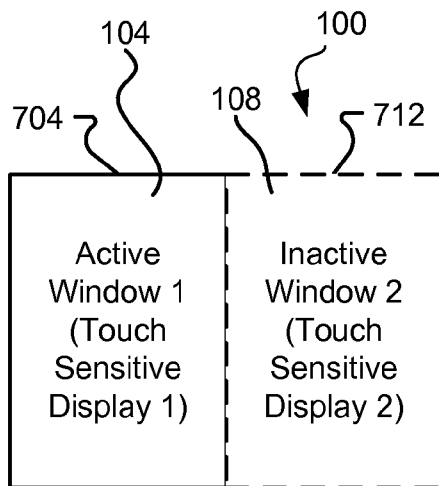

(57) Abstract: Systems and methods for moving a display during a device flip are provided. More particularly, in response to input or instructions selecting a secondary closed mode, operation of the device can be altered from a normal operating mode. In the secondary closed mode, when a device is moved from an open mode or state to a closed mode or state, the active window while the device was in the open mode is presented by a secondary screen, rather than a primary screen. The secondary closed mode is exited when the device is again placed in an open state or mode.

FIG. 10A

WO 2012/044788 A2

SE, SI, SK, SM, TR), OAPI (BF, BJ, CF, CG, CI, CM, GA, GN, GQ, GW, ML, MR, NE, SN, TD, TG).

Published:
— *without international search report and to be republished upon receipt of that report (Rule 48.2(g))*

METHOD AND APPARATUS FOR MOVING DISPLAY DURING A DEVICE FLIP

CROSS REFERENCE TO RELATED APPLICATION

[0001] The present application claims the benefits of and priority, under 35 U.S.C. § 119(e), to U.S. Provisional Application Serial Nos. 61/389,000, filed October 1, 2010, entitled “DUAL DISPLAY WINDOWING SYSTEM;” 61/389,117, filed October 1, 2010, entitled “MULTI-OPERATING SYSTEM PORTABLE DOCKETING DEVICE;” 61/389,087, filed October 1, 2010, entitled “TABLET COMPUTING USER INTERFACE;” 61/458,150, filed November 17, 2010, entitled “Dual Screen Email Client;” XX/XXXXXX, filed September XX, 2011, entitled “MOBILE DEVICE.” Each of the aforementioned documents is incorporated herein by this reference in their entirety for all that they teach and for all purposes.

BACKGROUND

[0002] A substantial number of handheld computing devices, such as cellular phones, tablets, and E-Readers, make use of a touch screen display not only to deliver display information to the user but also to receive inputs from user interface commands. While touch screen displays may increase the configurability of the handheld device and provide a wide variety of user interface options, this flexibility typically comes at a price. The dual use of the touch screen to provide content and receive user commands, while flexible for the user, may obfuscate the display and cause visual clutter, thereby leading to user frustration and loss of productivity.

[0003] The small form factor of handheld computing devices requires a careful balancing between the displayed graphics and the area provided for receiving inputs. On the one hand, the small display constrains the display space, which may increase the difficulty of interpreting actions or results. On the other, a virtual keypad or other user interface scheme is superimposed on or positioned adjacent to an executing application, requiring the application to be squeezed into an even smaller portion of the display.

[0004] This balancing act is particularly difficult for single display touch screen devices. Single display touch screen devices are crippled by their limited screen space. When users are entering information into the device, through the single display, the ability to interpret information in the display can be severely hampered, particularly when a complex interaction between display and interface is required.

SUMMARY

[0005] There is a need for a dual multi-display handheld computing device that provides for enhanced power and/or versatility compared to conventional single display handheld computing devices. These and other needs are addressed by the various aspects, embodiments, and/or configurations of the present disclosure. Also, while the disclosure is presented in terms of exemplary embodiments, it should be appreciated that individual aspects of the disclosure can be separately claimed.

In some embodiments, a method for controlling a display of a window on a device is provided, the method comprising:

presenting a first window by a primary screen of a multiple screen device, while the device is in an open mode;

receiving user input closing the device, thereby placing the device in a closed mode;

in response to the device being placed in the single screen mode, entering a secondary closed mode, wherein the first window is presented by a secondary screen of the multiple screen device.

In some embodiments, a device is provided, the device comprising:

at least first and second screens;

a hinge interconnecting the first and second screens;

memory;

a processor in communication with the at least first and second screens and the memory;

application programming stored in the memory and executed by the processor, wherein the application programming is operable to:

maintain at least a first and second sets of windows, wherein the first and second sets of windows are stored in the memory, wherein the first set of windows is associated with at least a first window and is associated with the first screen, and wherein the second set of windows is associated with at least a second window and is associated with the second screen;

present the first window in the first screen while the device is in an initial, open state;

receive a first user input, wherein the first user input includes the user placing the device in a closed state;

in response to the device being placed in the closed state, enter a secondary closed mode, wherein the first window is presented by a secondary screen of the device.

In some embodiments, a computer readable medium having stored thereon computer-executable instructions is provided, the computer executable instructions causing a processor to execute a method for controlling a user interface of a device, the computer-executable instructions comprising:

instructions to present a first window by a primary screen of the device, while the device is in an open mode;

instructions to detect receive user input closing the device, thereby placing the device in a closed mode;

in response to the device being placed in the closed mode, instructions to enter a secondary closed mode, wherein the first window is presented by a secondary screen of the device.

[0006] The present disclosure can provide a number of advantages depending on the particular aspect, embodiment, and/or configuration. Placing a window in a user interface on a secondary screen when the device is closed, rather than on a primary screen, provides a device having additional flexibility and user control options.

[0007] These and other advantages will be apparent from the disclosure.

[0008] The phrases “at least one”, “one or more”, and “and/or” are open-ended expressions that are both conjunctive and disjunctive in operation. For example, each of the expressions “at least one of A, B and C”, “at least one of A, B, or C”, “one or more of A, B, and C”, “one or more of A, B, or C” and “A, B, and/or C” means A alone, B alone, C alone, A and B together, A and C together, B and C together, or A, B and C together.

[0009] The term “a” or “an” entity refers to one or more of that entity. As such, the terms “a” (or “an”), “one or more” and “at least one” can be used interchangeably herein. It is also to be noted that the terms “comprising”, “including”, and “having” can be used interchangeably.

[0010] The term “automatic” and variations thereof, as used herein, refers to any process or operation done without material human input when the process or operation is

performed. However, a process or operation can be automatic, even though performance of the process or operation uses material or immaterial human input, if the input is received before performance of the process or operation. Human input is deemed to be material if such input influences how the process or operation will be performed. Human input that consents to the performance of the process or operation is not deemed to be “material”.

[0011] The term “computer-readable medium” as used herein refers to any tangible storage and/or transmission medium that participate in providing instructions to a processor for execution. Such a medium may take many forms, including but not limited to, non-volatile media, volatile media, and transmission media. Non-volatile media includes, for example, NVRAM, or magnetic or optical disks. Volatile media includes dynamic memory, such as main memory. Common forms of computer-readable media include, for example, a floppy disk, a flexible disk, hard disk, magnetic tape, or any other magnetic medium, magneto-optical medium, a CD-ROM, any other optical medium, punch cards, paper tape, any other physical medium with patterns of holes, a RAM, a PROM, and EPROM, a FLASH-EPROM, a solid state medium like a memory card, any other memory chip or cartridge, a carrier wave as described hereinafter, or any other medium from which a computer can read. A digital file attachment to e-mail or other self-contained information archive or set of archives is considered a distribution medium equivalent to a tangible storage medium. When the computer-readable media is configured as a database, it is to be understood that the database may be any type of database, such as relational, hierarchical, object-oriented, and/or the like. Accordingly, the disclosure is considered to include a tangible storage medium or distribution medium and prior art-recognized equivalents and successor media, in which the software implementations of the present disclosure are stored.

[0012] The term “desktop” refers to a metaphor used to portray systems. A desktop is generally considered a “surface” that typically includes pictures, called icons, widgets, folders, etc. that can activate show applications, windows, cabinets, files, folders, documents, and other graphical items. The icons are generally selectable to initiate a task through user interface interaction to allow a user to execute applications or conduct other operations.

[0013] The term “screen,” “touch screen,” or “touchscreen” refers to a physical structure that includes one or more hardware components that provide the device with the ability to render a user interface and/or receive user input. A screen can encompass any combination of gesture capture region, a touch sensitive display, and/or a configurable area. The device can have one or more physical screens embedded in the hardware. However a screen may also include an external peripheral device that may be attached and detached from the device. In embodiments, multiple external devices may be attached to the device. Thus, in embodiments, the screen can enable the user to interact with the device by touching areas on the screen and provides information to a user through a display. The touch screen may sense user contact in a number of different ways, such as by a change in an electrical parameter (e.g., resistance or capacitance), acoustic wave variations, infrared radiation proximity detection, light variation detection, and the like. In a resistive touch screen, for example, normally separated conductive and resistive metallic layers in the screen pass an electrical current. When a user touches the screen, the two layers make contact in the contacted location, whereby a change in electrical field is noted and the coordinates of the contacted location calculated. In a capacitive touch screen, a capacitive layer stores electrical charge, which is discharged to the user upon contact with the touch screen, causing a decrease in the charge of the capacitive layer. The decrease is measured, and the contacted location coordinates determined. In a surface acoustic wave touch screen, an acoustic wave is transmitted through the screen, and the acoustic wave is disturbed by user contact. A receiving transducer detects the user contact instance and determines the contacted location coordinates.

[0014] The term “display” refers to a portion of one or more screens used to display the output of a computer to a user. A display may be a single-screen display or a multi-screen display, referred to as a composite display. A composite display can encompass the touch sensitive display of one or more screens. A single physical screen can include multiple displays that are managed as separate logical displays. Thus, different content can be displayed on the separate displays although part of the same physical screen.

[0015] The term “displayed image” refers to an image produced on the display. A typical displayed image is a window or desktop. The displayed image may occupy all or a portion of the display.

[0016] The term “display orientation” refers to the way in which a rectangular display is oriented by a user for viewing. The two most common types of display orientation are portrait and landscape. In landscape mode, the display is oriented such that the width of the display is greater than the height of the display (such as a 4:3 ratio, which is 4 units wide and 3 units tall, or a 16:9 ratio, which is 16 units wide and 9 units tall). Stated differently, the longer dimension of the display is oriented substantially horizontal in landscape mode while the shorter dimension of the display is oriented substantially vertical. In the portrait mode, by contrast, the display is oriented such that the width of the display is less than the height of the display. Stated differently, the shorter dimension of the display is oriented substantially horizontal in the portrait mode while the longer dimension of the display is oriented substantially vertical.

[0017] The term “composited display” refers to a logical structure that defines a display that can encompass one or more screens. A multi-screen display can be associated with a composite display that encompasses all the screens. The composite display can have different display characteristics based on the various orientations of the device.

[0018] The term “gesture” refers to a user action that expresses an intended idea, action, meaning, result, and/or outcome. The user action can include manipulating a device (e.g., opening or closing a device, changing a device orientation, moving a trackball or wheel, etc.), movement of a body part in relation to the device, movement of an implement or tool in relation to the device, audio inputs, etc. A gesture may be made on a device (such as on the screen) or with the device to interact with the device.

[0019] The term “module” as used herein refers to any known or later developed hardware, software, firmware, artificial intelligence, fuzzy logic, or combination of hardware and software that is capable of performing the functionality associated with that element.

[0020] The term “gesture capture” refers to a sense or otherwise a detection of an instance and/or type of user gesture. The gesture capture can occur in one or more areas of the screen, A gesture region can be on the display, where it may be referred to as a touch sensitive display or off the display where it may be referred to as a gesture capture area.

[0021] A “multi-screen application” refers to an application that is capable of multiple modes. The multi-screen application mode can include, but is not limited to, a single

screen mode (where the application is displayed on a single screen) or a composite display mode (where the application is displayed on two or more screens). A multi-screen application can have different layouts optimized for the mode. Thus, the multi-screen application can have different layouts for a single screen or for a composite display that can encompass two or more screens. The different layouts may have different screen/display dimensions and/or configurations on which the user interfaces of the multi-screen applications can be rendered. The different layouts allow the application to optimize the application's user interface for the type of display, e.g., single screen or multiple screens. In single screen mode, the multi-screen application may present one window pane of information. In a composite display mode, the multi-screen application may present multiple window panes of information or may provide a larger and a richer presentation because there is more space for the display contents. The multi-screen applications may be designed to adapt dynamically to changes in the device and the mode depending on which display (single or composite) the system assigns to the multi-screen application. In alternative embodiments, the user can use a gesture to request the application transition to a different mode, and, if a display is available for the requested mode, the device can allow the application to move to that display and transition modes.

[0022] A "single-screen application" refers to an application that is capable of single screen mode. Thus, the single-screen application can produce only one window and may not be capable of different modes or different display dimensions. A single-screen application is incapable of the several modes discussed with the multi-screen application.

[0023] The term "window" refers to a, typically rectangular, displayed image on at least part of a display that contains or provides content different from the rest of the screen. The window may obscure the desktop. Moreover, the window can present an application, or can comprise a desktop view.

[0024] The terms "determine", "calculate" and "compute," and variations thereof, as used herein, are used interchangeably and include any type of methodology, process, mathematical operation or technique.

[0025] It shall be understood that the term "means" as used herein shall be given its broadest possible interpretation in accordance with 35 U.S.C., Section 112, Paragraph 6. Accordingly, a claim incorporating the term "means" shall cover all structures, materials, or acts set forth herein, and all of the equivalents thereof. Further, the structures, materials

or acts and the equivalents thereof shall include all those described in the summary of the invention, brief description of the drawings, detailed description, abstract, and claims themselves.

[0026] The preceding is a simplified summary of the disclosure to provide an understanding of some aspects of the disclosure. This summary is neither an extensive nor exhaustive overview of the disclosure and its various aspects, embodiments, and/or configurations. It is intended neither to identify key or critical elements of the disclosure nor to delineate the scope of the disclosure but to present selected concepts of the disclosure in a simplified form as an introduction to the more detailed description presented below. As will be appreciated, other aspects, embodiments, and/or configurations of the disclosure are possible utilizing, alone or in combination, one or more of the features set forth above or described in detail below.

BRIEF DESCRIPTION OF THE DRAWINGS

- [0027] FIG. 1A includes a first view of an embodiment of a multi-screen user device;
- [0028] FIG. 1B includes a second view of an embodiment of a multi-screen user device;
- [0029] FIG. 1C includes a third view of an embodiment of a multi-screen user device;
- [0030] FIG. 1D includes a fourth view of an embodiment of a multi-screen user device;
- [0031] FIG. 1E includes a fifth view of an embodiment of a multi-screen user device;
- [0032] FIG. 1F includes a sixth view of an embodiment of a multi-screen user device;
- [0033] FIG. 1G includes a seventh view of an embodiment of a multi-screen user device;
- [0034] FIG. 1H includes a eighth view of an embodiment of a multi-screen user device;
- [0035] FIG. 1I includes a ninth view of an embodiment of a multi-screen user device;
- [0036] FIG. 1J includes a tenth view of an embodiment of a multi-screen user device;
- [0037] FIG. 2 is a block diagram of an embodiment of the hardware of the device;
- [0038] FIG. 3A is a block diagram of an embodiment of the state model for the device based on the device's orientation and/or configuration;
- [0039] FIG. 3B is a table of an embodiment of the state model for the device based on the device's orientation and/or configuration;
- [0040] FIG. 4A is a first representation of an embodiment of user gesture received at a device;

- [0041] FIG. 4B is a second representation of an embodiment of user gesture received at a device;
- [0042] FIG. 4C is a third representation of an embodiment of user gesture received at a device;
- [0043] FIG. 4D is a fourth representation of an embodiment of user gesture received at a device;
- [0044] FIG. 4E is a fifth representation of an embodiment of user gesture received at a device;
- [0045] FIG. 4F is a sixth representation of an embodiment of user gesture received at a device;
- [0046] FIG. 4G is a seventh representation of an embodiment of user gesture received at a device;
- [0047] FIG. 4H is a eighth representation of an embodiment of user gesture received at a device;
- [0048] FIG. 5A is a block diagram of an embodiment of the device software and/or firmware;
- [0049] FIG. 5B is a second block diagram of an embodiment of the device software and/or firmware;
- [0050] FIG. 6A is a first representation of an embodiment of a device configuration generated in response to the device state;
- [0051] FIG. 6B is a second representation of an embodiment of a device configuration generated in response to the device state;
- [0052] FIG. 6C is a third representation of an embodiment of a device configuration generated in response to the device state;
- [0053] FIG. 6D is a fourth representation of an embodiment of a device configuration generated in response to the device state;
- [0054] FIG. 6E is a fifth representation of an embodiment of a device configuration generated in response to the device state;
- [0055] FIG. 6F is a sixth representation of an embodiment of a device configuration generated in response to the device state;
- [0056] FIG. 6G is a seventh representation of an embodiment of a device configuration generated in response to the device state;

- [0057] FIG. 6H is a eighth representation of an embodiment of a device configuration generated in response to the device state;
- [0058] FIG. 6I is a ninth representation of an embodiment of a device configuration generated in response to the device state;
- [0059] FIG. 6J is a tenth representation of an embodiment of a device configuration generated in response to the device state;
- [0060] FIG. 7A is representation of an embodiment of a user interface;
- [0061] FIG. 7B is another representation of an embodiment of a user interface;
- [0062] FIG. 7C is another representation of an embodiment of a user interface;
- [0063] FIG. 7D is another representation of an embodiment of a user interface;
- [0064] FIG. 7E is another representation of an embodiment of a user interface;
- [0065] FIG. 7F is another representation of an embodiment of a user interface;
- [0066] FIG. 7G is another representation of an embodiment of a user interface;
- [0067] FIG. 8 is block diagram of an embodiment of a data structure;
- [0068] FIG. 9 is a flow chart of an embodiment of a method for putting windows into a sleep state;
- [0069] FIG. 10A is a representation of a display output in accordance with embodiments of the present invention in a first example, with the device in an open mode;
- [0070] FIG. 10B is a representation of a primary display output in accordance with embodiments of the present invention, with the device in a secondary closed mode;
- [0071] FIG. 10C is a representation of a secondary display output in accordance with embodiments of the present invention, with the device in the secondary closed mode;
- [0072] FIG. 10D is a representation of a display output in accordance with embodiments of the present invention, with the device returned to the open mode; and
- [0073] FIG. 11 is a flowchart depicting aspects of the operation of a method for controlling a display of a window on a device in accordance with embodiments of the present invention.
- [0074] In the appended figures, similar components and/or features may have the same reference label. Further, various components of the same type may be distinguished by following the reference label by a letter that distinguishes among the similar components. If only the first reference label is used in the specification, the description is applicable to

any one of the similar components having the same first reference label irrespective of the second reference label.

DETAILED DESCRIPTION

[0100] Presented herein are embodiments of a device. The device can be a communications device, such as a cellular telephone, or other smart device. The device can include two screens that are oriented to provide several unique display configurations. Further, the device can receive user input in unique ways. The overall design and functionality of the device provides for an enhanced user experience making the device more useful and more efficient.

[0101] Mechanical Features:

[0102] Figs. 1A-1J illustrate a device 100 in accordance with embodiments of the present disclosure. As described in greater detail below, device 100 can be positioned in a number of different ways each of which provides different functionality to a user. The device 100 is a multi-screen device that includes a primary screen 104 and a secondary screen 108, both of which are touch sensitive. In embodiments, the entire front surface of screens 104 and 108 may be touch sensitive and capable of receiving input by a user touching the front surface of the screens 104 and 108. Primary screen 104 includes touch sensitive display 110, which, in addition to being touch sensitive, also displays information to a user. Secondary screen 108 includes touch sensitive display 114, which also displays information to a user. In other embodiments, screens 104 and 108 may include more than one display area.

[0103] Primary screen 104 also includes a configurable area 112 that has been configured for specific inputs when the user touches portions of the configurable area 112. Secondary screen 108 also includes a configurable area 116 that has been configured for specific inputs. Areas 112a and 116a have been configured to receive a “back” input indicating that a user would like to view information previously displayed. Areas 112b and 116b have been configured to receive a “menu” input indicating that the user would like to view options from a menu. Areas 112c and 116c have been configured to receive a “home” input indicating that the user would like to view information associated with a “home” view. In other embodiments, areas 112a-c and 116a-c may be configured, in addition to the configurations described above, for other types of specific inputs including controlling features of device 100, some non-limiting examples including adjusting overall

system power, adjusting the volume, adjusting the brightness, adjusting the vibration, selecting of displayed items (on either of screen 104 or 108), operating a camera, operating a microphone, and initiating/terminating of telephone calls. Also, in some embodiments, areas 112a-C and 116a-C may be configured for specific inputs depending upon the application running on device 100 and/or information displayed on touch sensitive displays 110 and/or 114.

[0104] In addition to touch sensing, primary screen 104 and secondary screen 108 may also include areas that receive input from a user without requiring the user to touch the display area of the screen. For example, primary screen 104 includes gesture capture area 120, and secondary screen 108 includes gesture capture area 124. These areas are able to receive input by recognizing gestures made by a user without the need for the user to actually touch the surface of the display area. In comparison to touch sensitive displays 110 and 114, the gesture capture areas 120 and 124 are commonly not capable of rendering a displayed image.

[0105] The two screens 104 and 108 are connected together with a hinge 128, shown clearly in Fig. 1C (illustrating a back view of device 100). Hinge 128, in the embodiment shown in Figs. 1A-1J, is a center hinge that connects screens 104 and 108 so that when the hinge is closed, screens 104 and 108 are juxtaposed (i.e., side-by-side) as shown in Fig. 1B (illustrating a front view of device 100). Hinge 128 can be opened to position the two screens 104 and 108 in different relative positions to each other. As described in greater detail below, the device 100 may have different functionalities depending on the relative positions of screens 104 and 108.

[0106] Fig. 1D illustrates the right side of device 100. As shown in Fig. 1D, secondary screen 108 also includes a card slot 132 and a port 136 on its side. Card slot 132 in embodiments, accommodates different types of cards including a subscriber identity module (SIM). Port 136 in embodiments is an input/output port (I/O port) that allows device 100 to be connected to other peripheral devices, such as a display, keyboard, or printing device. As can be appreciated, these are merely some examples and in other embodiments device 100 may include other slots and ports such as slots and ports for accommodating additional memory devices and/or for connecting other peripheral devices. Also shown in Fig. 1D is an audio jack 140 that accommodates a tip, ring, sleeve (TRS) connector for example to allow a user to utilize headphones or a headset.

[0107] Device 100 also includes a number of buttons 158. For example, Fig. 1E illustrates the left side of device 100. As shown in Fig. 1E, the side of primary screen 104 includes three buttons 144, 148, and 152, which can be configured for specific inputs. For example, buttons 144, 148, and 152 may be configured to, in combination or alone, control a number of aspects of device 100. Some non-limiting examples include overall system power, volume, brightness, vibration, selection of displayed items (on either of screen 104 or 108), a camera, a microphone, and initiation/termination of telephone calls. In some embodiments, instead of separate buttons two buttons may be combined into a rocker button. This arrangement is useful in situations where the buttons are configured to control features such as volume or brightness. In addition to buttons 144, 148, and 152, device 100 also includes a button 156, shown in Fig. 1F, which illustrates the top of device 100. In one embodiment, button 156 is configured as an on/off button used to control overall system power to device 100. In other embodiments, button 156 is configured to, in addition to or in lieu of controlling system power, control other aspects of device 100. In some embodiments, one or more of the buttons 144, 148, 152, and 156 are capable of supporting different user commands. By way of example, a normal press has a duration commonly of less than about 1 second and resembles a quick tap. A medium press has a duration commonly of 1 second or more but less than about 12 seconds. A long press has a duration commonly of about 12 seconds or more. The function of the buttons is normally specific to the application that is currently in focus on the respective display 110 and 114. In a telephone application for instance and depending on the particular button, a normal, medium, or long press can mean end call, increase in call volume, decrease in call volume, and toggle microphone mute. In a camera or video application for instance and depending on the particular button, a normal, medium, or long press can mean increase zoom, decrease zoom, and take photograph or record video.

[0108] There are also a number of hardware components within device 100. As illustrated in Fig. 1C, device 100 includes a speaker 160 and a microphone 164. Device 100 also includes a camera 168 (Fig. 1B). Additionally, device 100 includes two position sensors 172A and 172B, which are used to determine the relative positions of screens 104 and 108. In one embodiment, position sensors 172A and 172B are Hall effect sensors. However, in other embodiments other sensors can be used in addition to or in lieu of the Hall effect sensors. An accelerometer 176 may also be included as part of device 100 to

determine the orientation of the device 100 and/or the orientation of screens 104 and 108. Additional internal hardware components that may be included in device 100 are described below with respect to Fig. 2.

[0109] The overall design of device 100 allows it to provide additional functionality not available in other communication devices. Some of the functionality is based on the various positions and orientations that device 100 can have. As shown in Figs. 1B-1G, device 100 can be operated in an “open” position where screens 104 and 108 are juxtaposed. This position allows a large display area for displaying information to a user. When position sensors 172A and 172B determine that device 100 is in the open position, they can generate a signal that can be used to trigger different events such as displaying information on both screens 104 and 108. Additional events may be triggered if accelerometer 176 determines that device 100 is in a portrait position (Fig. 1B) as opposed to a landscape position (not shown).

[0110] In addition to the open position, device 100 may also have a “closed” position illustrated in Fig. 1H. Again, position sensors 172A and 172B can generate a signal indicating that device 100 is in the “closed” position. This can trigger an event that results in a change of displayed information on screen 104 and/or 108. For example, device 100 may be programmed to stop displaying information on one of the screens, e.g., screen 108, since a user can only view one screen at a time when device 100 is in the “closed” position. In other embodiments, the signal generated by position sensors 172A and 172B, indicating that the device 100 is in the “closed” position, can trigger device 100 to answer an incoming telephone call. The “closed” position can also be a preferred position for utilizing the device 100 as a mobile phone.

[0111] Device 100 can also be used in an “easel” position which is illustrated in Fig. 1I. In the “easel” position, screens 104 and 108 are angled with respect to each other and facing outward with the edges of screens 104 and 108 substantially horizontal. In this position, device 100 can be configured to display information on both screens 104 and 108 to allow two users to simultaneously interact with device 100. When device 100 is in the “easel” position, sensors 172A and 172B generate a signal indicating that the screens 104 and 108 are positioned at an angle to each other, and the accelerometer 176 can generate a signal indicating that device 100 has been placed so that the edge of screens 104 and 108

are substantially horizontal. The signals can then be used in combination to generate events that trigger changes in the display of information on screens 104 and 108.

[0112] Fig. 1J illustrates device 100 in a “modified easel” position. In the “modified easel” position, one of screens 104 or 108 is used as a stand and is faced down on the surface of an object such as a table. This position provides a convenient way for information to be displayed to a user in landscape orientation. Similar to the easel position, when device 100 is in the “modified easel” position, position sensors 172A and 172B generate a signal indicating that the screens 104 and 108 are positioned at an angle to each other. The accelerometer 176 would generate a signal indicating that device 100 has been positioned so that one of screens 104 and 108 is faced downwardly and is substantially horizontal. The signals can then be used to generate events that trigger changes in the display of information of screens 104 and 108. For example, information may not be displayed on the screen that is face down since a user cannot see the screen.

[0113] Transitional states are also possible. When the position sensors 172A and B and/or accelerometer indicate that the screens are being closed or folded (from open), a closing transitional state is recognized. Conversely when the position sensors 172A and B indicate that the screens are being opened or folded (from closed), an opening transitional state is recognized. The closing and opening transitional states are typically time-based, or have a maximum time duration from a sensed starting point. Normally, no user input is possible when one of the closing and opening states is in effect. In this manner, incidental user contact with a screen during the closing or opening function is not misinterpreted as user input. In embodiments, another transitional state is possible when the device 100 is closed. This additional transitional state allows the display to switch from one screen 104 to the second screen 108 when the device 100 is closed based on some user input, e.g., a double tap on the screen 110,114.

[0114] As can be appreciated, the description of device 100 is made for illustrative purposes only, and the embodiments are not limited to the specific mechanical features shown in Figs. 1A-1J and described above. In other embodiments, device 100 may include additional features, including one or more additional buttons, slots, display areas, hinges, and/or locking mechanisms. Additionally, in embodiments, the features described above may be located in different parts of device 100 and still provide similar functionality. Therefore, Figs. 1A-1J and the description provided above are nonlimiting.

[0115] Hardware Features:

[0116] Fig. 2 illustrates components of a device 100 in accordance with embodiments of the present disclosure. In general, the device 100 includes a primary screen 104 and a secondary screen 108. While the primary screen 104 and its components are normally enabled in both the opened and closed positions or states, the secondary screen 108 and its components are normally enabled in the opened state but disabled in the closed state. However, even when in the closed state a user or application triggered interrupt (such as in response to a phone application or camera application operation) can flip the active screen, or disable the primary screen 104 and enable the secondary screen 108, by a suitable command. Each screen 104, 108 can be touch sensitive and can include different operative areas. For example, a first operative area, within each touch sensitive screen 104 and 108, may comprise a touch sensitive display 110, 114. In general, the touch sensitive display 110, 114 may comprise a full color, touch sensitive display. A second area within each touch sensitive screen 104 and 108 may comprise a gesture capture region 120, 124. The gesture capture region 120, 124 may comprise an area or region that is outside of the touch sensitive display 110, 114 area, and that is capable of receiving input, for example in the form of gestures provided by a user. However, the gesture capture region 120, 124 does not include pixels that can perform a display function or capability.

[0117] A third region of the touch sensitive screens 104 and 108 may comprise a configurable area 112, 116. The configurable area 112, 116 is capable of receiving input and has display or limited display capabilities. In embodiments, the configurable area 112, 116 may present different input options to the user. For example, the configurable area 112, 116 may display buttons or other relatable items. Moreover, the identity of displayed buttons, or whether any buttons are displayed at all within the configurable area 112, 116 of a touch sensitive screen 104 or 108, may be determined from the context in which the device 100 is used and/or operated. In an exemplary embodiment, the touch sensitive screens 104 and 108 comprise liquid crystal display devices extending across at least those regions of the touch sensitive screens 104 and 108 that are capable of providing visual output to a user, and a capacitive input matrix over those regions of the touch sensitive screens 104 and 108 that are capable of receiving input from the user.

[0118] One or more display controllers 216a, 216b may be provided for controlling the operation of the touch sensitive screens 104 and 108, including input (touch sensing) and

output (display) functions. In the exemplary embodiment illustrated in Fig. 2, a separate touch screen controller 216a or 216b is provided for each touch screen 104 and 108. In accordance with alternate embodiments, a common or shared touch screen controller 216 may be used to control each of the included touch sensitive screens 104 and 108. In accordance with still other embodiments, the functions of a touch screen controller 216 may be incorporated into other components, such as a processor 204.

[0119] The processor 204 may comprise a general purpose programmable processor or controller for executing application programming or instructions. In accordance with at least some embodiments, the processor 204 may include multiple processor cores, and/or implement multiple virtual processors. In accordance with still other embodiments, the processor 204 may include multiple physical processors. As a particular example, the processor 204 may comprise a specially configured application specific integrated circuit (ASIC) or other integrated circuit, a digital signal processor, a controller, a hardwired electronic or logic circuit, a programmable logic device or gate array, a special purpose computer, or the like. The processor 204 generally functions to run programming code or instructions implementing various functions of the device 100.

[0120] A communication device 100 may also include memory 208 for use in connection with the execution of application programming or instructions by the processor 204, and for the temporary or long term storage of program instructions and/or data. As examples, the memory 208 may comprise RAM, DRAM, SDRAM, or other solid state memory. Alternatively or in addition, data storage 212 may be provided. Like the memory 208, the data storage 212 may comprise a solid state memory device or devices. Alternatively or in addition, the data storage 212 may comprise a hard disk drive or other random access memory.

[0121] In support of communications functions or capabilities, the device 100 can include a cellular telephony module 228. As examples, the cellular telephony module 228 can comprise a GSM, CDMA, FDMA and/or analog cellular telephony transceiver capable of supporting voice, multimedia and/or data transfers over a cellular network. Alternatively or in addition, the device 100 can include an additional or other wireless communications module 232. As examples, the other wireless communications module 232 can comprise a Wi-Fi, BLUETOOTH™, WiMax, infrared, or other wireless communications link. The cellular telephony module 228 and the other wireless

communications module 232 can each be associated with a shared or a dedicated antenna 224.

[0122] A port interface 252 may be included. The port interface 252 may include proprietary or universal ports to support the interconnection of the device 100 to other devices or components, such as a dock, which may or may not include additional or different capabilities from those integral to the device 100. In addition to supporting an exchange of communication signals between the device 100 and another device or component, the docking port 136 and/or port interface 252 can support the supply of power to or from the device 100. The port interface 252 also comprises an intelligent element that comprises a docking module for controlling communications or other interactions between the device 100 and a connected device or component.

[0123] An input/output module 248 and associated ports may be included to support communications over wired networks or links, for example with other communication devices, server devices, and/or peripheral devices. Examples of an input/output module 248 include an Ethernet port, a Universal Serial Bus (USB) port, Institute of Electrical and Electronics Engineers (IEEE) 1394, or other interface.

[0124] An audio input/output interface/device(s) 244 can be included to provide analog audio to an interconnected speaker or other device, and to receive analog audio input from a connected microphone or other device. As an example, the audio input/output interface/device(s) 244 may comprise an associated amplifier and analog to digital converter. Alternatively or in addition, the device 100 can include an integrated audio input/output device 256 and/or an audio jack for interconnecting an external speaker or microphone. For example, an integrated speaker and an integrated microphone can be provided, to support near talk or speaker phone operations.

[0125] Hardware buttons 158 can be included for example for use in connection with certain control operations. Examples include a master power switch, volume control, etc., as described in conjunction with Figs. 1A through 1J. One or more image capture interfaces/devices 240, such as a camera, can be included for capturing still and/or video images. Alternatively or in addition, an image capture interface/device 240 can include a scanner or code reader. An image capture interface/device 240 can include or be associated with additional elements, such as a flash or other light source.

[0126] The device 100 can also include a global positioning system (GPS) receiver 236. In accordance with embodiments of the present invention, the GPS receiver 236 may further comprise a GPS module that is capable of providing absolute location information to other components of the device 100. An accelerometer(s) 176 may also be included. For example, in connection with the display of information to a user and/or other functions, a signal from the accelerometer 176 can be used to determine an orientation and/or format in which to display that information to the user.

[0127] Embodiments of the present invention can also include one or more position sensor(s) 172. The position sensor 172 can provide a signal indicating the position of the touch sensitive screens 104 and 108 relative to one another. This information can be provided as an input, for example to a user interface application, to determine an operating mode, characteristics of the touch sensitive displays 110, 114, and/or other device 100 operations. As examples, a screen position sensor 172 can comprise a series of Hall effect sensors, a multiple position switch, an optical switch, a Wheatstone bridge, a potentiometer, or other arrangement capable of providing a signal indicating of multiple relative positions the touch screens are in.

[0128] Communications between various components of the device 100 can be carried by one or more buses 222. In addition, power can be supplied to the components of the device 100 from a power source and/or power control module 260. The power control module 260 can, for example, include a battery, an AC to DC converter, power control logic, and/or ports for interconnecting the device 100 to an external source of power.

[0129] Device State:

[0130] Figs. 3A and 3B represent illustrative states of device 100. While a number of illustrative states are shown, and transitions from a first state to a second state, it is to be appreciated that the illustrative state diagram may not encompass all possible states and/or all possible transitions from a first state to a second state. As illustrated in Fig. 3, the various arrows between the states (illustrated by the state represented in the circle) represent a physical change that occurs to the device 100, that is detected by one or more of hardware and software, the detection triggering one or more of a hardware and/or software interrupt that is used to control and/or manage one or more functions of device 100.

[0131] As illustrated in Fig. 3A, there are twelve exemplary “physical” states: closed 304, transition 308 (or opening transitional state), easel 312, modified easel 316, open 320, inbound/outbound call or communication 324, image/video capture 328, transition 332 (or closing transitional state), landscape 340, docked 336, docked 344 and landscape 348. Next to each illustrative state is a representation of the physical state of the device 100 with the exception of states 324 and 328, where the state is generally symbolized by the international icon for a telephone and the icon for a camera, respectfully.

[0132] In state 304, the device is in a closed state with the device 100 generally oriented in the portrait direction with the primary screen 104 and the secondary screen 108 back-to-back in different planes (see Fig. 1H). From the closed state, the device 100 can enter, for example, docked state 336, where the device 100 is coupled with a docking station, docking cable, or in general docked or associated with one or more other devices or peripherals, or the landscape state 340, where the device 100 is generally oriented with the primary screen 104 facing the user, and the primary screen 104 and the secondary screen 108 being back-to-back.

[0133] In the closed state, the device can also move to a transitional state where the device remains closed but the display is moved from one screen 104 to another screen 108 based on a user input, e.g., a double tap on the screen 110, 114. Still another embodiment includes a bilateral state. In the bilateral state, the device remains closed, but a single application displays at least one window on both the first display 110 and the second display 114. The windows shown on the first and second display 110, 114 may be the same or different based on the application and the state of that application. For example, while acquiring an image with a camera, the device may display the view finder on the first display 110 and displays a preview for the photo subjects (full screen and mirrored left-to-right) on the second display 114.

[0134] In state 308, a transition state from the closed state 304 to the semi-open state or easel state 312, the device 100 is shown opening with the primary screen 104 and the secondary screen 108 being rotated around a point of axis coincidence with the hinge. Upon entering the easel state 312, the primary screen 104 and the secondary screen 108 are separated from one another such that, for example, the device 100 can sit in an easel-like configuration on a surface.

[0135] In state 316, known as the modified easel position, the device 100 has the primary screen 104 and the secondary screen 108 in a similar relative relationship to one another as in the easel state 312, with the difference being one of the primary screen 104 or the secondary screen 108 are placed on a surface as shown.

[0136] State 320 is the open state where the primary screen 104 and the secondary screen 108 are generally on the same plane. From the open state, the device 100 can transition to the docked state 344 or the open landscape state 348. In the open state 320, the primary screen 104 and the secondary screen 108 are generally in the portrait-like orientation while in landscaped state 348 the primary screen 104 and the secondary screen 108 are generally in a landscape-like orientation.

[0137] State 324 is illustrative of a communication state, such as when an inbound or outbound call is being received or placed, respectively, by the device 100. While not illustrated for clarity, it should be appreciated the device 100 can transition to the inbound/outbound call state 324 from any state illustrated in Fig. 3. In a similar manner, the image/video capture state 328 can be entered into from any other state in Fig. 3, with the image/video capture state 328 allowing the device 100 to take one or more images via a camera and/or videos with a video capture device 240.

[0138] Transition state 322 illustratively shows primary screen 104 and the secondary screen 108 being closed upon one another for entry into, for example, the closed state 304.

[0139] Fig. 3B illustrates, with reference to the key, the inputs that are received to detect a transition from a first state to a second state. In Fig. 3B, various combinations of states are shown with in general, a portion of the columns being directed toward a portrait state 352, a landscape state 356, and a portion of the rows being directed to portrait state 360 and landscape state 364.

[0140] In Fig. 3B, the Key indicates that “H” represents an input from one or more Hall Effect sensors, “A” represents an input from one or more accelerometers, “T” represents an input from a timer, “P” represents a communications trigger input and “I” represents an image and/or video capture request input. Thus, in the center portion 376 of the chart, an input, or combination of inputs, are shown that represent how the device 100 detects a transition from a first physical state to a second physical state.

[0141] As discussed, in the center portion of the chart 376, the inputs that are received enable the detection of a transition from, for example, a portrait open state to a landscape

easel state - shown in bold – “HAT.” For this exemplary transition from the portrait open to the landscape easel state, a Hall Effect sensor (“H”), an accelerometer (“A”) and a timer (“T”) input may be needed. The timer input can be derived from, for example, a clock associated with the processor.

[0142] In addition to the portrait and landscape states, a docked state 368 is also shown that is triggered based on the receipt of a docking signal 372. As discussed above and in relation to Fig. 3, the docking signal can be triggered by the association of the device 100 with one or more other device 100s, accessories, peripherals, smart docks, or the like.

[0143] User Interaction:

[0144] Figs. 4A through 4H depict various graphical representations of gesture inputs that may be recognized by the screens 104, 108. The gestures may be performed not only by a user’s body part, such as a digit, but also by other devices, such as a stylus, that may be sensed by the contact sensing portion(s) of a screen 104, 108. In general, gestures are interpreted differently, based on where the gestures are performed (either directly on the display 110, 114 or in the gesture capture region 120, 124). For example, gestures in the display 110, 114 may be directed to a desktop or application, and gestures in the gesture capture region 120, 124 may be interpreted as for the system.

[0145] With reference to Figs. 4A-4H, a first type of gesture, a touch gesture 420, is substantially stationary on the screen 104, 108 for a selected length of time. A circle 428 represents a touch or other contact type received at particular location of a contact sensing portion of the screen. The circle 428 may include a border 432, the thickness of which indicates a length of time that the contact is held substantially stationary at the contact location. For instance, a tap 420 (or short press) has a thinner border 432a than the border 432b for a long press 424 (or for a normal press). The long press 424 may involve a contact that remains substantially stationary on the screen for longer time period than that of a tap 420. As will be appreciated, differently defined gestures may be registered depending upon the length of time that the touch remains stationary prior to contact cessation or movement on the screen.

[0146] With reference to Fig. 4C, a drag gesture 400 on the screen 104, 108 is an initial contact (represented by circle 428) with contact movement 436 in a selected direction. The initial contact 428 may remain stationary on the screen 104, 108 for a certain amount of time represented by the border 432. The drag gesture typically requires the user to contact

an icon, window, or other displayed image at a first location followed by movement of the contact in a drag direction to a new second location desired for the selected displayed image. The contact movement need not be in a straight line but have any path of movement so long as the contact is substantially continuous from the first to the second locations.

[0147] With reference to Fig. 4D, a flick gesture 404 on the screen 104,108 is an initial contact (represented by circle 428) with truncated contact movement 436 (relative to a drag gesture) in a selected direction. In embodiments, a flick has a higher exit velocity for the last movement in the gesture compared to the drag gesture. The flick gesture can, for instance, be a finger snap following initial contact. Compared to a drag gesture, a flick gesture generally does not require continual contact with the screen 104,108 from the first location of a displayed image to a predetermined second location. The contacted displayed image is moved by the flick gesture in the direction of the flick gesture to the predetermined second location. Although both gestures commonly can move a displayed image from a first location to a second location, the temporal duration and distance of travel of the contact on the screen is generally less for a flick than for a drag gesture.

[0148] With reference to Fig. 4E, a pinch gesture 408 on the screen 104,108 is depicted. The pinch gesture 408 may be initiated by a first contact 428 to the screen 104,108 by, for example, a first digit and a second contact 428b to the screen 104,108 by, for example, a second digit. The first and second contacts 428a,b may be detected by a common contact sensing portion of a common screen 104,108, by different contact sensing portions of a common screen 104 or 108, or by different contact sensing portions of different screens. The first contact 428a is held for a first amount of time, as represented by the border 432a, and the second contact 428b is held for a second amount of time, as represented by the border 432b. The first and second amounts of time are generally substantially the same, and the first and second contacts 428 a, b generally occur substantially simultaneously. The first and second contacts 428 a, b generally also include corresponding first and second contact movements 436 a, b, respectively. The first and second contact movements 436 a, b are generally in opposing directions. Stated another way, the first contact movement 436a is towards the second contact 436b, and the second contact movement 436b is towards the first contact 436a. More simply stated, the pinch gesture 408 may be accomplished by a user's digits touching the screen 104,108 in a pinching motion.

[0149] With reference to Fig. 4F, a spread gesture 410 on the screen 104,108 is depicted. The spread gesture 410 may be initiated by a first contact 428a to the screen 104,108 by, for example, a first digit and a second contact 428b to the screen 104,108 by, for example, a second digit. The first and second contacts 428a,b may be detected by a common contact sensing portion of a common screen 104,108, by different contact sensing portions of a common screen 104,108, or by different contact sensing portions of different screens. The first contact 428a is held for a first amount of time, as represented by the border 432a, and the second contact 428b is held for a second amount of time, as represented by the border 432b. The first and second amounts of time are generally substantially the same, and the first and second contacts 428 a, b generally occur substantially simultaneously. The first and second contacts 428 a, b generally also include corresponding first and second contact movements 436a, b, respectively. The first and second contact movements 436 a, b are generally in a common direction. Stated another way, the first and second contact movements 436 a, b are away from the first and second contacts 428a, b. More simply stated, the spread gesture 410 may be accomplished by a user's digits touching the screen 104,108 in a spreading motion.

[0150] The above gestures may be combined in any manner, such as those shown by Figs. 4G and 4H, to produce a determined functional result. For example, in Fig. 4G a tap gesture 420 is combined with a drag or flick gesture 412 in a direction away from the tap gesture 420. In Fig. 4H, a tap gesture 420 is combined with a drag or flick gesture 412 in a direction towards the tap gesture 420.

[0151] The functional result of receiving a gesture can vary depending on a number of factors, including a state of the device 100, display 110, 114, or screen 104, 108, a context associated with the gesture, or sensed location of the gesture. The state of the device commonly refers to one or more of a configuration of the device 100, a display orientation, and user and other inputs received by the device 100. Context commonly refers to one or more of the particular application(s) selected by the gesture and the portion(s) of the application currently executing, whether the application is a single- or multi-screen application, and whether the application is a multi-screen application displaying one or more windows in one or more screens or in one or more stacks. Sensed location of the gesture commonly refers to whether the sensed set(s) of gesture location coordinates are on a touch sensitive display 110, 114 or a gesture capture region 120, 124, whether the

sensed set(s) of gesture location coordinates are associated with a common or different display or screen 104,108, and/or what portion of the gesture capture region contains the sensed set(s) of gesture location coordinates.

[0152] A tap, when received by an a touch sensitive display 110, 114, can be used, for instance, to select an icon to initiate or terminate execution of a corresponding application, to maximize or minimize a window, to reorder windows in a stack, and to provide user input such as by keyboard display or other displayed image. A drag, when received by a touch sensitive display 110, 114, can be used, for instance, to relocate an icon or window to a desired location within a display, to reorder a stack on a display, or to span both displays (such that the selected window occupies a portion of each display simultaneously). A flick, when received by a touch sensitive display 110, 114 or a gesture capture region 120, 124, can be used to relocate a window from a first display to a second display or to span both displays (such that the selected window occupies a portion of each display simultaneously). Unlike the drag gesture, however, the flick gesture is generally not used to move the displayed image to a specific user-selected location but to a default location that is not configurable by the user.

[0153] The pinch gesture, when received by a touch sensitive display 110, 114 or a gesture capture region 120, 124, can be used to minimize or otherwise increase the displayed area or size of a window (typically when received entirely by a common display), to switch windows displayed at the top of the stack on each display to the top of the stack of the other display (typically when received by different displays or screens), or to display an application manager (a “pop-up window” that displays the windows in the stack). The spread gesture, when received by a touch sensitive display 110, 114 or a gesture capture region 120, 124, can be used to maximize or otherwise decrease the displayed area or size of a window, to switch windows displayed at the top of the stack on each display to the top of the stack of the other display (typically when received by different displays or screens), or to display an application manager (typically when received by an off-screen gesture capture region on the same or different screens).

[0154] The combined gestures of Fig. 4G, when received by a common display capture region in a common display or screen 104,108, can be used to hold a first window stack location in a first stack constant for a display receiving the gesture while reordering a second window stack location in a second window stack to include a window in the

display receiving the gesture. The combined gestures of Fig. 4H, when received by different display capture regions in a common display or screen 104,108 or in different displays or screens, can be used to hold a first window stack location in a first window stack constant for a display receiving the tap part of the gesture while reordering a second window stack location in a second window stack to include a window in the display receiving the flick or drag gesture. Although specific gestures and gesture capture regions in the preceding examples have been associated with corresponding sets of functional results, it is to be appreciated that these associations can be redefined in any manner to produce differing associations between gestures and/or gesture capture regions and/or functional results.

[0155] Firmware and Software:

[0156] The memory 508 may store and the processor 504 may execute one or more software components. These components can include at least one operating system (OS) 516, an application manager 562, a desktop 566, and/or one or more applications 564a and/or 564b from an application store 560. The OS 516 can include a framework 520, one or more frame buffers 548, one or more drivers 512, previously described in conjunction with Fig. 2, and/or a kernel 518. The OS 516 can be any software, consisting of programs and data, which manages computer hardware resources and provides common services for the execution of various applications 564. The OS 516 can be any operating system and, at least in some embodiments, dedicated to mobile devices, including, but not limited to, Linux, ANDROID™, iPhone OS (IOS™), WINDOWS PHONE 7™, etc. The OS 516 is operable to provide functionality to the phone by executing one or more operations, as described herein.

[0157] The applications 564 can be any higher level software that executes particular functionality for the user. Applications 564 can include programs such as email clients, web browsers, texting applications, games, media players, office suites, etc. The applications 564 can be stored in an application store 560, which may represent any memory or data storage, and the management software associated therewith, for storing the applications 564. Once executed, the applications 564 may be run in a different area of memory 508.

[0158] The framework 520 may be any software or data that allows the multiple tasks running on the device to interact. In embodiments, at least portions of the framework 520

and the discrete components described hereinafter may be considered part of the OS 516 or an application 564. However, these portions will be described as part of the framework 520, but those components are not so limited. The framework 520 can include, but is not limited to, a Multi-Display Management (MDM) module 524, a Surface Cache module 528, a Window Management module 532, an Input Management module 536, a Task Management module 540, an Application Model Manager 542, a Display Controller, one or more frame buffers 548, a task stack 552, one or more window stacks 550 (which is a logical arrangement of windows and/or desktops in a display area), and/or an event buffer 556.

[0159] The MDM module 524 includes one or more modules that are operable to manage the display of applications or other data on the screens of the device. An embodiment of the MDM module 524 is described in conjunction with Fig. 5B. In embodiments, the MDM module 524 receives inputs from the other OS 516 components, such as, the drivers 512, and from the applications 564 to determine continually the state of the device 100. The inputs assist the MDM module 524 in determining how to configure and allocate the displays according to the application's preferences and requirements, and the user's actions. Once a determination for display configurations is made, the MDM module 524 can bind the applications 564 to a display. The configuration may then be provided to one or more other components to generate a window with a display.

[0160] The Surface Cache module 528 includes any memory or storage and the software associated therewith to store or cache one or more images of windows. A series of active and/or non-active windows (or other display objects, such as, a desktop display) can be associated with each display. An active window (or other display object) is currently displayed. A non-active windows (or other display objects) were opened and, at some time, displayed but are now not displayed. To enhance the user experience, before a window transitions from an active state to an inactive state, a "screen shot" of a last generated image of the window (or other display object) can be stored. The Surface Cache module 528 may be operable to store a bitmap of the last active image of a window (or other display object) not currently displayed. Thus, the Surface Cache module 528 stores the images of non-active windows (or other display objects) in a data store.

[0161] In embodiments, the Window Management module 532 is operable to manage the windows (or other display objects) that are active or not active on each of the displays. The Window Management module 532, based on information from the MDM module 524, the OS 516, or other components, determines when a window (or other display object) is visible or not active. The Window Management module 532 may then put a non-visible window (or other display object) in a “not active state” and, in conjunction with the Task Management module Task Management 540 suspends the application’s operation. Further, the Window Management module 532 may assign, through collaborative interaction with the MDM module 524, a display identifier to the window (or other display object) or manage one or more other items of data associated with the window (or other display object). The Window Management module 532 may also provide the stored information to the application 564, the Task Management module 540, or other components interacting with or associated with the window (or other display object). The Window Management module 532 can also associate an input task with a window based on window focus and display coordinates within the motion space.

[0162] The Input Management module 536 is operable to manage events that occur with the device. An event is any input into the window environment, for example, a user interface interactions with a user. The Input Management module 536 receives the events and logically stores the events in an event buffer 556. Events can include such user interface interactions as a “down event,” which occurs when a screen 104, 108 receives a touch signal from a user, a “move event,” which occurs when the screen 104, 108 determines that a user’s finger is moving across a screen(s), an “up event, which occurs when the screen 104, 108 determines that the user has stopped touching the screen 104, 108, etc. These events are received, stored, and forwarded to other modules by the Input Management module 536. The Input Management module 536 may also map screen inputs to a motion space which is the culmination of all physical and virtual display available on the device.

[0163] The motion space is a virtualized space that includes all touch sensitive displays 110,114 “tiled” together to mimic the physical dimensions of the device 100. For example, when the device 100 is unfolded, the motion space size may be 960x800, which may be the number of pixels in the combined display area for both touch sensitive displays 110, 114. If a user touches on a first touch sensitive display 110 on location (40, 40), a full

screen window can receive touch event with location (40, 40). If a user touches on a second touch sensitive display 114, with location (40, 40), the full screen window can receive touch event with location (520, 40), because the second touch sensitive display 114 is on the right side of the first touch sensitive display 110, so the device 100 can offset the touch by the first touch sensitive display's 110 width, which is 480 pixels. When a hardware event occurs with location info from a driver 512, the framework 520 can up-scale the physical location to the motion space because the location of the event may be different based on the device orientation and state. The motion space may be as described in U.S. Patent Application No. 13/187,026, filed July 20, 2011, entitled "Systems and Methods for Receiving Gesture Inputs Spanning Multiple Input Devices," which is hereby incorporated by reference in its entirety for all that it teaches and for all purposes.

[0164] A task can be an application and a sub-task can be an application component that provides a window with which users can interact to do something, such as dial the phone, take a photo, send an email, or view a map. Each task may be given a window in which to draw a user interface. The window typically fills a display (for example, touch sensitive display 110,114), but may be smaller than the display 110,114 and float on top of other windows. An application usually consists of multiple sub-tasks that are loosely bound to each other. Typically, one task in an application is specified as the "main" task, which is presented to the user when launching the application for the first time. Each task can then start another task or sub-task to perform different actions.

[0165] The Task Management module 540 is operable to manage the operation of one or more applications 564 that may be executed by the device. Thus, the Task Management module 540 can receive signals to launch, suspend, terminate, etc. an application or application sub-tasks stored in the application store 560. The Task Management module 540 may then instantiate one or more tasks or sub-tasks of the application 564 to begin operation of the application 564. Further, the Task Management Module 540 may launch, suspend, or terminate a task or sub-task as a result of user input or as a result of a signal from a collaborating framework 520 component. The Task Management Module 540 is responsible for managing the lifecycle of applications (tasks and sub-task) from when the application is launched to when the application is terminated.

[0166] The processing of the Task Management Module 540 is facilitated by a task stack 552, which is a logical structure associated with the Task Management Module 540.

The task stack 552 maintains the state of all tasks and sub-tasks on the device 100. When some component of the operating system 516 requires a task or sub-task to transition in its lifecycle, the OS 516 component can notify the Task Management Module 540. The Task Management Module 540 may then locate the task or sub-task, using identification information, in the task stack 552, and send a signal to the task or sub-task indicating what kind of lifecycle transition the task needs to execute. Informing the task or sub-task of the transition allows the task or sub-task to prepare for the lifecycle state transition. The Task Management Module 540 can then execute the state transition for the task or sub-task. In embodiments, the state transition may entail triggering the OS kernel 518 to terminate the task when termination is required.

[0167] Further, the Task Management module 540 may suspend the application 564 based on information from the Window Management Module 532. Suspending the application 564 may maintain application data in memory but may limit or stop the application 564 from rendering a window or user interface. Once the application becomes active again, the Task Management module 540 can again trigger the application to render its user interface. In embodiments, if a task is suspended, the task may save the task's state in case the task is terminated. In the suspended state, the application task may not receive input because the application window is not visible to the user.

[0168] The frame buffer 548 is a logical structure(s) used to render the user interface. The frame buffer 548 can be created and destroyed by the OS kernel 518. However, the Display Controller 544 can write the image data, for the visible windows, into the frame buffer 548. A frame buffer 548 can be associated with one screen or multiple screens. The association of a frame buffer 548 with a screen can be controlled dynamically by interaction with the OS kernel 518. A composite display may be created by associating multiple screens with a single frame buffer 548. Graphical data used to render an application's window user interface may then be written to the single frame buffer 548, for the composite display, which is output to the multiple screens 104,108. The Display Controller 544 can direct an application's user interface to a portion of the frame buffer 548 that is mapped to a particular display 110,114, thus, displaying the user interface on only one screen 104 or 108. The Display Controller 544 can extend the control over user interfaces to multiple applications, controlling the user interfaces for as many displays as are associated with a frame buffer 548 or a portion thereof. This approach compensates

for the multiple physical screens 104,108 that are in use by the software component above the Display Controller 544.

[0169] The Application Manager 562 is an application that provides a presentation layer for the window environment. Thus, the Application Manager 562 provides the graphical model for rendering by the Task Management Module 540. Likewise, the Desktop 566 provides the presentation layer for the Application Store 560. Thus, the desktop provides a graphical model of a surface having selectable application icons for the Applications 564 in the Application Store 560 that can be provided to the Window Management Module 556 for rendering.

[0170] Further, the framework can include an Application Model Manager (AMM) 542. The Application Manager 562 may interface with the AMM 542. In embodiments, the AMM 542 receives state change information from the device 100 regarding the state of applications (which are running or suspended). The AMM 542 can associate bit map images from the Surface Cache Module 528 to the tasks that are alive (running or suspended). Further, the AMM 542 can convert the logical window stack maintained in the Task Manager Module 540 to a linear (“film strip” or “deck of cards”) organization that the user perceives when the using the off gesture capture area 120 to sort through the windows. Further, the AMM 542 may provide a list of executing applications to the Application Manager 562.

[0171] An embodiment of the MDM module 524 is shown in Fig. 5B. The MDM module 524 is operable to determine the state of the environment for the device, including, but not limited to, the orientation of the device, whether the device 100 is opened or closed, what applications 564 are executing, how the applications 564 are to be displayed, what actions the user is conducting, the tasks being displayed, etc. To configure the display, the MDM module 524 interprets these environmental factors and determines a display configuration, as described in conjunction with Figs. 6A-6J. Then, the MDM module 524 can bind the applications 564 or other device components to the displays. The configuration may then be sent to the Display Controller 544 and/or the other components within the OS 516 to generate the display. The MDM module 524 can include one or more of, but is not limited to, a Display Configuration Module 568, a Preferences Module 572, a Device State Module 574, a Gesture Module 576, a Requirements Module 580, an Event Module 584, and/or a Binding Module 588.

[0172] The Display Configuration Module 568 determines the layout for the display. In embodiments, the Display Configuration Module 568 can determine the environmental factors. The environmental factors may be received from one or more other MDM modules 524 or from other sources. The Display Configuration Module 568 can then determine from the list of factors the best configuration for the display. Some embodiments of the possible configurations and the factors associated therewith are described in conjunction with Figs. 6A-6F.

[0173] The Preferences Module 572 is operable to determine display preferences for an application 564 or other component. For example, an application can have a preference for Single or Dual displays. The Preferences Module 572 can determine an application's display preference (e.g., by inspecting the application's preference settings) and may allow the application 564 to change to a mode (e.g., single screen, dual screen, max, etc.) if the device 100 is in a state that can accommodate the preferred mode. However, some user interface policies may disallow a mode even if the mode is available. As the configuration of the device changes, the preferences may be reviewed to determine if a better display configuration can be achieved for an application 564.

[0174] The Device State Module 574 is operable to determine or receive the state of the device. The state of the device can be as described in conjunction with Figs. 3A and 3B. The state of the device can be used by the Display Configuration Module 568 to determine the configuration for the display. As such, the Device State Module 574 may receive inputs and interpret the state of the device. The state information is then provided to the Display Configuration Module 568.

[0175] The Gesture Module 576 is shown as part of the MDM module 524, but, in embodiments, the Gesture module 576 may be a separate Framework 520 component that is separate from the MDM module 524. In embodiments, the Gesture Module 576 is operable to determine if the user is conducting any actions on any part of the user interface. In alternative embodiments, the Gesture Module 576 receives user interface actions from the configurable area 112,116 only. The Gesture Module 576 can receive touch events that occur on the configurable area 112,116 (or possibly other user interface areas) by way of the Input Management Module 536 and may interpret the touch events (using direction, speed, distance, duration, and various other parameters) to determine what kind of gesture the user is performing. When a gesture is interpreted, the Gesture

Module 576 can initiate the processing of the gesture and, by collaborating with other Framework 520 components, can manage the required window animation. The Gesture Module 576 collaborates with the Application Model Manager 542 to collect state information with respect to which applications are running (active or paused) and the order in which applications must appear when a user gesture is performed. The Gesture Module 576 may also receive references to bitmaps (from the Surface Cache Module 528) and live windows so that when a gesture occurs it can instruct the Display Controller 544 how to move the window(s) across the display 110,114. Thus, suspended applications may appear to be running when those windows are moved across the display 110,114.

[0176] Further, the Gesture Module 576 can receive task information either from the Task Manage Module 540 or the Input Management module 536. The gestures may be as defined in conjunction with Figs. 4A through 4H. For example, moving a window causes the display to render a series of display frames that illustrate the window moving. The gesture associated with such user interface interaction can be received and interpreted by the Gesture Module 576. The information about the user gesture is then sent to the Task Management Module 540 to modify the display binding of the task.

[0177] The Requirements Module 580, similar to the Preferences Module 572, is operable to determine display requirements for an application 564 or other component. An application can have a set display requirement that must be observed. Some applications require a particular display orientation. For example, the application “Angry Birds” can only be displayed in landscape orientation. This type of display requirement can be determined or received, by the Requirements Module 580. As the orientation of the device changes, the Requirements Module 580 can reassert the display requirements for the application 564. The Display Configuration Module 568 can generate a display configuration that is in accordance with the application display requirements, as provided by the Requirements Module 580.

[0178] The Event Module 584, similar to the Gesture Module 576, is operable to determine one or more events occurring with an application or other component that can affect the user interface. Thus, the Event Module 584 can receive event information either from the event buffer 556 or the Task Management module 540. These events can change how the tasks are bound to the displays. The Event Module 584 can collect state change information from other Framework 520 components and act upon that state change

information. In an example, when the phone is opened or closed or when an orientation change has occurred, a new message may be rendered in a secondary screen. The state change based on the event can be received and interpreted by the Event Module 584. The information about the events then may be sent to the Display Configuration Module 568 to modify the configuration of the display.

[0179] The Binding Module 588 is operable to bind the applications 564 or the other components to the configuration determined by the Display Configuration Module 568. A binding associates, in memory, the display configuration for each application with the display and mode of the application. Thus, the Binding Module 588 can associate an application with a display configuration for the application (e.g. landscape, portrait, multi-screen, etc.). Then, the Binding Module 588 may assign a display identifier to the display. The display identifier associated the application with a particular display of the device 100. This binding is then stored and provided to the Display Controller 544, the other components of the OS 516, or other components to properly render the display. The binding is dynamic and can change or be updated based on configuration changes associated with events, gestures, state changes, application preferences or requirements, etc.

[0180] User Interface Configurations:

[0181] With reference now to Figs. 6A-J, various types of output configurations made possible by the device 100 will be described hereinafter.

[0182] Figs. 6A and 6B depict two different output configurations of the device 100 being in a first state. Specifically, Fig. 6A depicts the device 100 being in a closed portrait state 304 where the data is displayed on the primary screen 104. In this example, the device 100 displays data via the touch sensitive display 110 in a first portrait configuration 604. As can be appreciated, the first portrait configuration 604 may only display a desktop or operating system home screen. Alternatively, one or more windows may be presented in a portrait orientation while the device 100 is displaying data in the first portrait configuration 604.

[0183] Fig. 6B depicts the device 100 still being in the closed portrait state 304, but instead data is displayed on the secondary screen 108. In this example, the device 100 displays data via the touch sensitive display 114 in a second portrait configuration 608.

[0184] It may be possible to display similar or different data in either the first or second portrait configuration 604, 608. It may also be possible to transition between the first portrait configuration 604 and second portrait configuration 608 by providing the device 100 a user gesture (e.g., a double tap gesture), a menu selection, or other means. Other suitable gestures may also be employed to transition between configurations.

Furthermore, it may also be possible to transition the device 100 from the first or second portrait configuration 604, 608 to any other configuration described herein depending upon which state the device 100 is moved.

[0185] An alternative output configuration may be accommodated by the device 100 being in a second state. Specifically, Fig. 6C depicts a third portrait configuration where data is displayed simultaneously on both the primary screen 104 and the secondary screen 108. The third portrait configuration may be referred to as a Dual-Portrait (PD) output configuration. In the PD output configuration, the touch sensitive display 110 of the primary screen 104 depicts data in the first portrait configuration 604 while the touch sensitive display 114 of the secondary screen 108 depicts data in the second portrait configuration 608. The simultaneous presentation of the first portrait configuration 604 and the second portrait configuration 608 may occur when the device 100 is in an open portrait state 320. In this configuration, the device 100 may display one application window in one display 110 or 114, two application windows (one in each display 110 and 114), one application window and one desktop, or one desktop. Other configurations may be possible. It should be appreciated that it may also be possible to transition the device 100 from the simultaneous display of configurations 604, 608 to any other configuration described herein depending upon which state the device 100 is moved. Furthermore, while in this state, an application's display preference may place the device into bilateral mode, in which both displays are active to display different windows in the same application. For example, a Camera application may display a viewfinder and controls on one side, while the other side displays a mirrored preview that can be seen by the photo subjects. Games involving simultaneous play by two players may also take advantage of bilateral mode.

[0186] Figs. 6D and 6E depicts two further output configurations of the device 100 being in a third state. Specifically, Fig. 6D depicts the device 100 being in a closed landscape state 340 where the data is displayed on the primary screen 104. In this

example, the device 100 displays data via the touch sensitive display 110 in a first landscape configuration 612. Much like the other configurations described herein, the first landscape configuration 612 may display a desktop, a home screen, one or more windows displaying application data, or the like.

[0187] Fig. 6E depicts the device 100 still being in the closed landscape state 340, but instead data is displayed on the secondary screen 108. In this example, the device 100 displays data via the touch sensitive display 114 in a second landscape configuration 616. It may be possible to display similar or different data in either the first or second portrait configuration 612, 616. It may also be possible to transition between the first landscape configuration 612 and second landscape configuration 616 by providing the device 100 with one or both of a twist and tap gesture or a flip and slide gesture. Other suitable gestures may also be employed to transition between configurations. Furthermore, it may also be possible to transition the device 100 from the first or second landscape configuration 612, 616 to any other configuration described herein depending upon which state the device 100 is moved.

[0188] Fig. 6F depicts a third landscape configuration where data is displayed simultaneously on both the primary screen 104 and the secondary screen 108. The third landscape configuration may be referred to as a Dual-Landscape (LD) output configuration. In the LD output configuration, the touch sensitive display 110 of the primary screen 104 depicts data in the first landscape configuration 612 while the touch sensitive display 114 of the secondary screen 108 depicts data in the second landscape configuration 616. The simultaneous presentation of the first landscape configuration 612 and the second landscape configuration 616 may occur when the device 100 is in an open landscape state 340. It should be appreciated that it may also be possible to transition the device 100 from the simultaneous display of configurations 612, 616 to any other configuration described herein depending upon which state the device 100 is moved.

[0189] Figs. 6G and 6H depict two views of a device 100 being in yet another state. Specifically, the device 100 is depicted as being in an easel state 312. Fig. 6G shows that a first easel output configuration 618 may be displayed on the touch sensitive display 110. Fig. 6H shows that a second easel output configuration 620 may be displayed on the touch sensitive display 114. The device 100 may be configured to depict either the first easel output configuration 618 or the second easel output configuration 620 individually.

Alternatively, both the easel output configurations 618, 620 may be presented simultaneously. In some embodiments, the easel output configurations 618, 620 may be similar or identical to the landscape output configurations 612, 616. The device 100 may also be configured to display one or both of the easel output configurations 618, 620 while in a modified easel state 316. It should be appreciated that simultaneous utilization of the easel output configurations 618, 620 may facilitate two-person games (e.g., Battleship®, chess, checkers, etc.), multi-user conferences where two or more users share the same device 100, and other applications. As can be appreciated, it may also be possible to transition the device 100 from the display of one or both configurations 618, 620 to any other configuration described herein depending upon which state the device 100 is moved.

[0190] Fig. 6I depicts yet another output configuration that may be accommodated while the device 100 is in an open portrait state 320. Specifically, the device 100 may be configured to present a single continuous image across both touch sensitive displays 110, 114 in a portrait configuration referred to herein as a Portrait-Max (PMax) configuration 624. In this configuration, data (e.g., a single image, application, window, icon, video, etc.) may be split and displayed partially on one of the touch sensitive displays while the other portion of the data is displayed on the other touch sensitive display. The Pmax configuration 624 may facilitate a larger display and/or better resolution for displaying a particular image on the device 100. Similar to other output configurations, it may be possible to transition the device 100 from the Pmax configuration 624 to any other output configuration described herein depending upon which state the device 100 is moved.

[0191] Fig. 6J depicts still another output configuration that may be accommodated while the device 100 is in an open landscape state 348. Specifically, the device 100 may be configured to present a single continuous image across both touch sensitive displays 110, 114 in a landscape configuration referred to herein as a Landscape-Max (LMax) configuration 628. In this configuration, data (e.g., a single image, application, window, icon, video, etc.) may be split and displayed partially on one of the touch sensitive displays while the other portion of the data is displayed on the other touch sensitive display. The Lmax configuration 628 may facilitate a larger display and/or better resolution for displaying a particular image on the device 100. Similar to other output configurations, it may be possible to transition the device 100 from the Lmax

configuration 628 to any other output configuration described herein depending upon which state the device 100 is moved.

[0192] The device 100 manages desktops and/or windows within a user interface 700, as shown in Figs. 7A through 7G. A user interface 700 is a logical arrangement of active and inactive windows for a multi-screen device. For example, the user interface 700 may be logically similar to a deck of cards or a film strip, where one or more windows or desktops are arranged in order, as shown in Fig. 7A. An active window is a window that is currently being displayed on at least one of the touch sensitive displays 110, 114. For example, window 1 704 and window 3 708 are active windows and are displayed on touch sensitive displays 110 and 114, respectively. An inactive window is a window that was opened and displayed but is now “behind” an active window and not being displayed. In embodiments, an inactive window may be for an application that is suspended in a “sleep state”, and thus, the window is not displaying active content. For example, window 2 712 is an inactive window in the sleep state.

[0193] A user interface 700 may have various arrangements or organizational structures. In the embodiment shown in Fig. 7A, the device 100 includes a set of windows/display objects or windows stack associated with a first touch sensitive display 110 and a second set of windows/display objects or windows stack associated with a second touch sensitive display 114. Thus, each touch sensitive display 110, 114 can have an associated set of windows/display objects. The two sets of windows/display objects may have different numbers of windows and may be arranged differently. Further, the two sets of windows/display objects can also be identified differently and managed separately. Thus, the first set of windows/display objects can be arranged in order from a first window to a last window. Likewise, the second set of windows/display objects can be arranged from a first window to a last window, but may have more or fewer windows. A logical data structure for managing the sets of windows/display objects may be as described in conjunction with Fig. 8.

[0194] When a window is moved, the newly moved window is repositioned within the user interface 700. Where and how the window is positioned within the user interface 700 can be a function of the orientation of the device 100, the context of what programs, functions, software, etc. are being executed on the device 100, how the user interface 700 is arranged when a new window is opened, when a window is moved, etc. To change the

window position in the user interface 700, the window is moved by a user and information associated with the window can change. With this information, a logical data structure for the window can be changed and stored. When user interface or other events or tasks change the arrangement of windows, the user interface 700 can be changed to reflect the change in arrangement. It should be noted that these same concepts described above can be used to manage the one or more desktops for the device 100.

[0195] For example, an arrangement of windows in a user interface can be shown in “profile” views in Figs. 7B through 7G. A top view is shown in Figs. 7B and 7G. Side views are shown in Figs. 7C-7F. Here, the logical arrangement of the user interface 700 is shown where, the active windows 704 and 708 are shown in Fig. 7B. The windows 704 and 708 can be the top most windows in portions of a composite display 720, which represents the total area of all the touch sensitive displays 110,114. As shown in Figs. 7C and 7D, window 1 704 and window 3 708 are at the top of the set of windows/display objects. The windows “beneath” the top windows, window 1 704 and window 3 708, are not active. Rather, window 2 712, which is not displayed, is inactive or in a sleep state. In a sleep state, the window 2 712 does not receive inputs. Further, the window need not generate a user interface window. As such, by setting the window 2 712 inactive, the processor saves on processor cycles and required code execution. When a window is “awakened”, it is brought back to an active status, begins receiving inputs, and renders a window user interface. As shown in Figs. 7C and 7D, window 2 712 is below window 3 708 and not displayed, which changes in the embodiment shown in Figs. 7E and 7F.

[0196] In Figs. 7E through 7G, window 3 708 is moved from the second touch sensitive display 114 onto a first touch sensitive display 110 by gesture or other input to the device 110. In moving window 3 704, window 1 704 is covered and becomes inactive. Window 2 712 is exposed and becomes active. When a window 1 704 becomes inactive, a bitmap of the last view of the window is stored. The bitmap can be used when windows transfer onto the active display(s). Thus, the window appears to be active when transitioning but is not actually rendering a user interface until the transition is complete, and the window becomes active. Window 2 712 appears as the bitmap until window 3 708 has completed the move to the first touch sensitive display 110, and window 2 becomes active, as shown on Fig. 7G.

[0197] A logical data structure 800 for managing the arrangement of windows or desktops in a window user interface 700 is shown in Fig. 8. The logical data structure 800 can be any data structure used to store data whether an object, record, file, etc. The logical data structure 800 can be stored in any type of database or data storage system, regardless of protocol or standard. In embodiments, the logical data structure 800 includes one or more portions, fields, attributes, etc. that store data in a logical arrangement that allows for easy storage and retrieval of the information. Hereinafter, these one or more portions, fields, attributes, etc. shall be described simply as fields. The fields can store data for a window identifier 804, a dimension 808, a window stack position identifier 812, a display identifier 816, and/or an active indicator 820. Each window in a window user interface 700 can have an associated logical data structure 800. While only a single logical data structure 800 is shown in Fig. 8, there may be more or fewer logical data structures 800 used with a window user interface 700 (based on the number of windows or desktops in the user interface 700), as represented by ellipses 824. Further, there may be more or fewer fields than those shown in Fig. 8, as represented by ellipses 828.

[0198] A window identifier 804 can include any identifier (ID) that uniquely identifies the associated window in relation to other windows in the window user interface 700. The window identifier 804 can be a globally unique identifier (GUID), a numeric ID, an alphanumeric ID, or other type of identifier. In embodiments, the window identifier 804 can be one, two, or any number of digits based on the number of windows that can be opened. In alternative embodiments, the size of the window identifier 804 may change based on the number of windows opened. While the window is open, the window identifier 804 may be static and remain unchanged.

[0199] Dimensions 808 can include dimensions for the window. The dimensions 808 can limit the window to a portion or all of the composite display 720. Thus, the dimensions 808 can be a set of display coordinates for the window. For example, the window can include a first set of coordinates for a first corner and a second set of coordinates for a second corner. In other embodiments, the dimensions 808 can include one set of coordinates and a length and width, measured in pixels or other measure.

[0200] A window stack position identifier 812 can be any identifier that can identify the position in the window stack for the window. The window stack position identifier 812 can be a GUID, a numeric ID, an alphanumeric ID, or other type of identifier. Each

window or desktop can include a window stack position identifier 812. For example, as shown in Fig. 7C, window 3 708, in a window stack, can have a window stack position identifier 812 of 1 identifying that window 708 is the first window in the window stack and the active window. Similarly, window 2 712 can have a window stack position identifier 812 of 2 representing that window 712 is the second window in the window stack. Window 1 704 can also have a window stack position identifier 812 of 3 representing that window 704 is the third window in the window stack.

[0201] A display identifier 816 can identify that the window or desktop is associated with either the first display 110 or the second display 114. While this display identifier 816 may not be needed for a dual user interface 700 system, as shown in Fig. 7A, the display identifier 816 can indicate whether a window in the serial user interface 700 is displayed on a particular display. Thus, window 3 708 may have a display identifier 816 of 2 in Fig. 7D. Window 1 704 can have a display identifier 816 of 1 for the first display 110. However, in alternative embodiments, the window may have two display indicators 816 that represent that the window is displayed on both of the displays 110, 114 or may have a single identifier identifying the composite display 720.

[0202] Similar to the display identifier 816, an active indicator 820 may not be needed with the dual user interface 700 system. In the device 100, the active indicator 820 can indicate which window(s) in the user interface 700 is being displayed. Thus, window 1 704 may have an active indicator 820 in Fig. 7D but may not have an active indicator in Fig. 7E.

[0203] An embodiment of a method 900 for creating a window user interface 700 is shown in Fig. 9. While a general order for the steps of the method 900 is shown in Fig. 9. Generally, the method 900 starts with a start operation 904 and ends with an end operation 924. The method 900 can include more or fewer steps or can arrange the order of the steps differently than those shown in Fig. 9. The method 900 can be executed as a set of computer-executable instructions executed by a computer system and encoded or stored on a computer readable medium. Hereinafter, the method 900 shall be explained with reference to the systems, components, modules, software, data structures, user interfaces, etc. described in conjunction with Figs. 1-8.

[0204] A multi-screen device 100 can receive a movement of a window or other user interface event (such as the closure of a window, opening of a new window, revealing a

desktop, etc.), in step 908. While other user interface events are possible, the process 900 will be explained using a window movement as an example. One skilled in the art will understand how to apply the process 900 to other types of user interface events. In embodiments, the multi-screen device 100 can receive a window movement by receiving an input from the touch sensitive display 110 or 114, the configurable area 112 or 116, a gesture capture region 120 or 124, or some other hardware sensor operable to receive user interface inputs. The display controller 544 may send the input signal to the processor 204 for processing. The processor 204 can interpret the input signal as a gesture, described in conjunction with Figs. 4A-4F, or other user input that moves an active or inactive window or moves a desktop. Upon receiving the gesture, the processor 204 can move the window. For example, window 3 708 can be moved onto the top of the first touch sensitive display 110, which makes window 2 712 active, as shown in Figs. 7E through 7G.

[0205] In embodiments, the processor 204 places the user interface interaction in the buffer 556 to be acted upon by the Input Management Module 536. Further, the processor 204 activates the inactive application, *i.e.*, activates the application from a suspended or sleep state. The application management class 540 may bind the application 564 to current display parameters. The device state module 574 of the Multi-Display Management class 524 may then determine how to rearrange the application in the user interface 700. Further, the device state module 574 may time the movement of a window. For example, before inactivating or activating a window, the device state module 574 may execute a timer. Only after the move is complete and the timer has expired will the device state module 574 activate or inactivate a window. The timer ensures that, if the user is flipping through multiple windows, then a window will not become active or other windows will not be put to sleep until the rapid movement of several windows ceases. The timer saves processor resources in not having to render user interfaces that will only be covered shortly thereafter.

[0206] The device state module 574 can first determine if the moved window has changed position in the user interface 700, in step 912. In other words, the device state module 574 determines to what position on the user interface, e.g., which display or to what position in a window stack, the window has been moved. Further, the device state module 574 may determine whether the movement of the window caused some other window to be covered in the user interface 700, in step 916. For example, the movement

of window 3 708, show in Figs. 7E through 7G has changed the position of window 3 708 to the first touch sensitive display 110, has covered window 1 704, and has uncovered window 2 712. The device state module 574 determines these types of effects based on a window movement or other user interface event (e.g., opening a new window, closing a window, revealing the desktop, etc.).

[0207] Further, the display configuration module 568 places the hidden windows into a sleep state and activates uncovered windows, in step 920. Thus, the display configuration module 568 can change the active indicator 820 for the windows that are uncovered or covered in the user interface 700. For example, window 1 704, which is covered in the embodiment shown in Fig. 7F, will have the active indicator eliminated to put the window to sleep. In the inactive or sleep state, window 1 stops receiving user interface inputs and stops rendering a user interface window. Further, window 2 712 has its active indicator set to acknowledge that window 2 712 is now active, receiving inputs, and rendering a window user interface. This sleep state information is passed to the Task Management Module 540 to instruct the Window Management Module 532 to render the new user interface 700 with the new active windows displayed and the other windows placed in the sleep state.

[0208] Fig. 10A depicts an output of the device 100 in an open state. In this example, first and second windows 704 and 712 are displayed by a first or primary screen 104 and a second or secondary screen 108 respectively. Moreover, in this example, the first window 704 is active, and the second window 712 is inactive.

[0209] In accordance with embodiments of the present invention, when the device 100 is placed in a closed state, operation of the secondary screen 108 is typically discontinued. However, in accordance with other embodiments of the present invention, a secondary closed mode can be activated, according to which the information that had been displayed in the primary screen 104 is displayed by the secondary screen 108. The secondary closed mode can be activated in various ways. For example, an application associated with a primary window 104 (e.g., window 1 704) can include instructions that cause the application window to be displayed by the secondary screen 108 when the device 100 is placed in the closed position or mode. Accordingly, this flip and slide action performed when entering the secondary closed mode can be initiated automatically when the device 100 is placed in the closed mode. In accordance with other embodiments of the present

invention, the secondary closed mode can be activated manually. For example, a user can manually initiate the secondary closed mode by performing a twist and tap operation that includes closing the device, positioning the device so that the secondary screen 108 is in view of the user, and tapping the secondary screen. In accordance with a further embodiment, a user input comprising double tapping the gesture region or gesture capture area 120 of the primary screen 104 can provide a modal or sub-window that allows the user to enter an input to switch the active display from the primary screen 104 to the secondary screen 108. In accordance with other embodiments, activation of the secondary single screen mode can be performed through a menu item, or through the selection of a user interface toggle or other object or input presenting an option to enter the secondary closed mode.

[0210] As shown in Fig. 10B, in accordance with at least some embodiments of the present invention, the primary screen 104 may display an instruction message when the device 100 is closed and the secondary closed mode is entered. For purposes of illustration, and without limitation, the instruction screen 1004 may display a text message such as “please turn over” to the user on the primary screen 104. Moreover, the instruction message 1004 may be discontinued after a predetermined period of time, as counted by a timer, has elapsed. After that predetermined period of time has elapsed, the primary screen 104 can be placed in an inactive or idle state.

[0211] With reference now to Fig. 10C, after entering the secondary closed mode, the window 704 that had been presented by the primary screen 104 while the device 100 was in the open mode or position (as shown in Fig. 10A) is presented by the secondary screen 108. In addition to presenting the active window on the secondary screen 108, the active window can be associated with the set of windows for the secondary screen 108. Accordingly, windowing management inputs entered while the device 100 is in the secondary closed mode operate with respect to the set of windows associated with the secondary screen 108.

[0212] As shown in Fig. 10D, in response to returning the device 100 to the open state following operation in the secondary closed mode, operation of the primary window is reinitiated or enabled. In accordance with embodiments of the present invention, when the device 100 is opened after being in the secondary closed mode, the application or window at the top of the set of windows associated with the primary screen 104 is displayed by the

primary screen 104, while the active window continues to be displayed by the secondary screen 108. In addition, when the device 100 is returned to the open mode, the secondary closed mode is exited. More particularly, the device 100 will follow normal operation if it is again placed in the closed mode, with only the primary screen 104 active after the device 100 is placed in the closed state. Accordingly, absent a further instruction to activate the secondary closed mode provided as user input or in response to application programming associated with an active window as described above, the secondary closed mode will not be reinitiated. The secondary closed mode is therefore considered a temporary state of the device 100. Moreover, apart from the active window (e.g., the first window 704) being placed in the set of windows associated with the secondary screen 108, the effects of the secondary closed mode are terminated after the device 100 has been placed back into the open position.

[0213] Fig. 11 illustrates aspects of a method for moving the active display when the device 100 is placed in a closed mode or state in accordance with embodiments of the present invention. Initially, at step 1104, the device 100 is in an open state or mode, with an active window presented on the primary screen 104. The secondary screen 108 typically displays an inactive window or a desktop. Alternatively, the secondary screen 108 can be in an idle or powered off state. At step 1108, a determination is made as to whether user input in the form of placing the device 100 in a closed state or mode has been received. Until the device is closed, the process may idle at step 1108.

[0214] After the device has been placed in the closed state, a determination can be made as to whether an input or instruction to enter a secondary closed mode has been received (step 1112). As described elsewhere herein, input to enter the secondary closed mode can be in the form of a manual selection or input provided by a user. Alternatively, instructions to enter the secondary closed mode can be provided as part of the instructions associated with the active application. If such input has not been received, the device is operated in the normal closed screen mode, in which the primary screen 104 is active, and the secondary screen 108 is inactive (step 1114). The process can then end.

[0215] Where an input or instruction to enter the secondary closed mode has been received, the active window is presented on the secondary screen 108, and that window is associated with the set of windows for the secondary screen 108 (step 1116). In accordance with at least some embodiments of the present invention, an instruction

message can be presented on the primary screen 104 (step 1120). This instruction generally includes a message to the user to turn or flip the device over so that the secondary screen 108 is in the view of the user, in case the user is viewing the primary screen 104 when the secondary closed mode is entered. Moreover, this instruction can be delivered as text presented by the primary screen 104. If presented, the instructions can be discontinued, and the primary screen can be placed in an idle or powered off mode, after a predetermined period of time has elapsed since the secondary closed mode was entered.

[0216] At step 1124, a determination can be made as to whether the device 100 has been placed in an open state. If the device 100 has not been opened, the device 100 continues to operate in the secondary closed mode (step 1128). In the secondary closed mode, window management operations are performed with respect to the set of windows associated with the secondary screen 108.

[0217] If the device 100 has been opened, the secondary closed mode is discontinued (step 1132). After the secondary closed mode has been discontinued and the device 100 is in the open state, the active window continues to be presented by the secondary screen 108. In addition, the window presented by the secondary screen remains a part of the set of windows associated with the secondary screen 108, unless windowing management input moving that window to the set of windows associated with the primary screen is received. The window that was on the top of the stack or set of windows associated with the primary screen 104, after the active window was moved to the stack or set of windows associated with the secondary screen 108, is displayed by the primary window 104. After reentering the open mode, the process for operating in the secondary closed mode ends.

[0218] In accordance with embodiments of the present invention, after the secondary closed mode has been exited, closing the device does not reactivate the secondary closed mode, absent input or instructions to do so, as described above. Accordingly, the secondary closed mode is therefore a temporary device state.

[0219] In accordance with embodiments of the present invention, the method disclosed herein can be performed by the execution of application programming or other software components stored in memory 208, 508 by a processor 204, 504. For instance the operating system 516, a component or components of the framework 520, and/or a component or components of the multi-display management module 524 can include or provide functionality to operate the device 100 in a secondary single screen mode and

associated modes as described herein. Moreover, embodiments of the present invention can provide the described method and functionality through the operation of a user interface 700, and an arrangement of windows including windows arranged in at least first and second sets, as described herein.

[0220] Although the method has, at least in some examples, been described in connection with a device having a primary 104 and secondary 108 screens, it should be appreciated by one of skill in the art after consideration of the present disclosure that embodiments of the present invention can be implemented in connection with more than two screens of a device 100. In addition, embodiments of the present invention can be implemented in connection with a device 100 presenting or implementing multiple virtual screens in addition to multiple physical screens.

[0221] Various other exemplary systems and methods of this disclosure have been described in relation to the operation of a device in a closed state. However, such other systems and methods can be applied to operation of a single screen device, or alternatively to a device with more than two screens. In addition, embodiments of the present invention can be implemented in connection with a device 100 presenting or implementing multiple virtual screens.

[0222] Although embodiments of systems and methods have been described in connection with various structures and attributes, in order to avoid unnecessarily obscuring the present disclosure, the preceding description omits a number of known structures and devices. This omission is not to be construed as a limitation of the scopes of the claims. Specific details are set forth to provide an understanding of the present disclosure. It should however be appreciated that the present disclosure may be practiced in a variety of ways beyond the specific detail set forth herein.

[0223] Furthermore, while the exemplary aspects, embodiments, and/or configurations illustrated herein show the various components of the system collocated, certain components of the system can be located remotely, at distant portions of a distributed network, such as a LAN and/or the Internet, or within a dedicated system. Thus, it should be appreciated, that the components of the system can be combined in to one or more devices, such as the software modules of Figs. 5A and 5B, or collocated on a particular node of a distributed network, such as an analog and/or digital telecommunications network, a packet-switch network, or a circuit-switched network. It will be appreciated

from the preceding description, and for reasons of computational efficiency, that the components of the system can be arranged at any location within a distributed network of components without affecting the operation of the system. For example, the various components can be located in a switch such as a PBX and media server, gateway, in one or more communications devices, at one or more users' premises, or some combination thereof. Similarly, one or more functional portions of the system could be distributed between a telecommunications device(s) and an associated computing device.

[0224] Furthermore, it should be appreciated that the various links connecting the elements can be wired or wireless links, or any combination thereof, or any other known or later developed element(s) that is capable of supplying and/or communicating data to and from the connected elements. These wired or wireless links can also be secure links and may be capable of communicating encrypted information. Transmission media used as links, for example, can be any suitable carrier for electrical signals, including coaxial cables, copper wire and fiber optics, and may take the form of acoustic or light waves, such as those generated during radio-wave and infra-red data communications.

[0225] Also, while the flowcharts have been discussed and illustrated in relation to a particular sequence of events, it should be appreciated that changes, additions, and omissions to this sequence can occur without materially affecting the operation of the disclosed embodiments, configuration, and aspects.

[0226] A number of variations and modifications of the disclosure can be used. It would be possible to provide for some features of the disclosure without providing others. For example in one alternative embodiment, the window stack maintained in connection with the user interface 700 resembles a carousel or rolodex rather than a deck of cards. Thus, windows may circulate from one touch sensitive display 110 to another touch sensitive display 114. For example, window 6 724 may be pushed to the right and end up at the end of stack 764 behind window 716. If the stack continues to move to the right, eventually window 6 724 would appear on the second touch sensitive display 114 even though the window 724 was opened in the first touch sensitive display 110. These movements and changes in the stacks may be managed using the methods and logical data structures discussed above. In another alternative embodiment, there may be other arrangements for the window stack.

[0227] In yet another embodiment, the systems and methods of this disclosure can be implemented in conjunction with a special purpose computer, a programmed microprocessor or microcontroller and peripheral integrated circuit element(s), an ASIC or other integrated circuit, a digital signal processor, a hard-wired electronic or logic circuit such as discrete element circuit, a programmable logic device or gate array such as PLD, PLA, FPGA, PAL, special purpose computer, any comparable means, or the like. In general, any device(s) or means capable of implementing the methodology illustrated herein can be used to implement the various aspects of this disclosure. Exemplary hardware that can be used for the disclosed embodiments, configurations and aspects includes computers, handheld devices, telephones (e.g., cellular, Internet enabled, digital, analog, hybrids, and others), and other hardware known in the art. Some of these devices include processors (e.g., a single or multiple microprocessors), memory, nonvolatile storage, input devices, and output devices. Furthermore, alternative software implementations including, but not limited to, distributed processing or component/object distributed processing, parallel processing, or virtual machine processing can also be constructed to implement the methods described herein.

[0228] In yet another embodiment, the disclosed methods may be readily implemented in conjunction with software using object or object-oriented software development environments that provide portable source code that can be used on a variety of computer or workstation platforms. Alternatively, the disclosed system may be implemented partially or fully in hardware using standard logic circuits or VLSI design. Whether software or hardware is used to implement the systems in accordance with this disclosure is dependent on the speed and/or efficiency requirements of the system, the particular function, and the particular software or hardware systems or microprocessor or microcomputer systems being utilized.

[0229] In yet another embodiment, the disclosed methods may be partially implemented in software that can be stored on a storage medium, executed on programmed general-purpose computer with the cooperation of a controller and memory, a special purpose computer, a microprocessor, or the like. In these instances, the systems and methods of this disclosure can be implemented as program embedded on personal computer such as an applet, JAVA® or CGI script, as a resource residing on a server or computer workstation, as a routine embedded in a dedicated measurement system, system component, or the like.

The system can also be implemented by physically incorporating the system and/or method into a software and/or hardware system.

[0230] Although the present disclosure describes components and functions implemented in the aspects, embodiments, and/or configurations with reference to particular standards and protocols, the aspects, embodiments, and/or configurations are not limited to such standards and protocols. Other similar standards and protocols not mentioned herein are in existence and are considered to be included in the present disclosure. Moreover, the standards and protocols mentioned herein and other similar standards and protocols not mentioned herein are periodically superseded by faster or more effective equivalents having essentially the same functions. Such replacement standards and protocols having the same functions are considered equivalents included in the present disclosure.

[0231] The present disclosure, in various aspects, embodiments, and/or configurations, includes components, methods, processes, systems and/or apparatus substantially as depicted and described herein, including various aspects, embodiments, configurations, embodiments, subcombinations, and/or subsets thereof. Those of skill in the art will understand how to make and use the disclosed aspects, embodiments, and/or configurations after understanding the present disclosure. The present disclosure, in various aspects, embodiments, and/or configurations, includes providing devices and processes in the absence of items not depicted and/or described herein or in various aspects, embodiments, and/or configurations hereof, including in the absence of such items as may have been used in previous devices or processes, e.g., for improving performance, achieving ease and/or reducing cost of implementation.

[0232] The foregoing discussion has been presented for purposes of illustration and description. The foregoing is not intended to limit the disclosure to the form or forms disclosed herein. In the foregoing Detailed Description for example, various features of the disclosure are grouped together in one or more aspects, embodiments, and/or configurations for the purpose of streamlining the disclosure. The features of the aspects, embodiments, and/or configurations of the disclosure may be combined in alternate aspects, embodiments, and/or configurations other than those discussed above. This method of disclosure is not to be interpreted as reflecting an intention that the claims require more features than are expressly recited in each claim. Rather, as the following

claims reflect, inventive aspects lie in less than all features of a single foregoing disclosed aspect, embodiment, and/or configuration. Thus, the following claims are hereby incorporated into this Detailed Description, with each claim standing on its own as a separate preferred embodiment of the disclosure.

[0233] Moreover, though the description has included description of one or more aspects, embodiments, and/or configurations and certain variations and modifications, other variations, combinations, and modifications are within the scope of the disclosure, e.g., as may be within the skill and knowledge of those in the art, after understanding the present disclosure. It is intended to obtain rights which include alternative aspects, embodiments, and/or configurations to the extent permitted, including alternate, interchangeable and/or equivalent structures, functions, ranges or steps to those claimed, whether or not such alternate, interchangeable and/or equivalent structures, functions, ranges or steps are disclosed herein, and without intending to publicly dedicate any patentable subject matter.

What is claimed is:

1. A method for controlling a display of a window on a device, comprising:
presenting a first window by a primary screen of a multiple screen device, while the device is in an open mode;
receiving user input closing the device, thereby placing the device in a closed mode;
in response to the device being placed in the single screen mode, entering a secondary closed mode, wherein the first window is presented by a secondary screen of the multiple screen device.
2. The method of claim 1, further comprising:
in response to the device entering the secondary closed mode, discontinuing the presentation of the first window by the primary screen.
3. The method of claim 2, further comprising:
in response to the device entering the secondary closed mode, displaying an instruction on the primary screen.
4. The method of claim 3, wherein the displaying an instruction is discontinued after a predetermined period of time.
5. The method of claim 4, wherein the instruction is to turn the device over so that the secondary screen is in view of the user.
6. The method of claim 1, wherein entering the secondary closed mode in response to the device being placed in the closed mode is performed in accordance with application instructions associated with the first window.
7. The method of claim 1, wherein entering the secondary closed mode in response to the device being placed in the closed mode is performed in accordance with a user input directing that the first window be presented by the secondary screen.
8. The method of claim 1, wherein while presenting the first window by a primary screen the first window is associated with a first set of windows, and wherein in response to entering the secondary closed mode the first window is associated with a second set of windows.
9. The method of claim 1, further comprising:

after entering the secondary closed mode, receiving user input placing the device in the open mode, wherein the first window continues to be displayed by the secondary screen.

10. The method of claim 9, wherein the user input placing the device in the open mode after entering the secondary screen mode discontinues the secondary closed mode.

11. A device, comprising:
at least first and second screens;
a hinge interconnecting the first and second screens;
memory;
a processor in communication with the at least first and second screens and the memory;

application programming stored in the memory and executed by the processor, wherein the application programming is operable to:

maintain at least a first and second sets of windows, wherein the first and second sets of windows are stored in the memory, wherein the first set of windows is associated with at least a first window and is associated with the first screen, and wherein the second set of windows is associated with at least a second window and is associated with the second screen;

present the first window in the first screen while the device is in an initial, open state;

receive a first user input, wherein the first user input includes the user placing the device in a closed state;

in response to the device being placed in the closed state, enter a secondary closed mode, wherein the first window is presented by a secondary screen of the device.

12. The device of claim 11, wherein the application programming is further operable to display an instruction on the primary screen in response to the device entering the secondary closed mode.

13. The device of claim 11, wherein the application programming is further operable to disassociate the first window from the first set of windows and to associate the first window with the second set of windows.

14. The device of claim 11, further comprising:
a position sensor, wherein the application programming is further operable to detect the mode of the device in response to a signal from the position sensor.

15. The device of claim 11, further comprising:
at least one of a touch sensitive display area or a gesture capture area included in at least the second screen, wherein the application programming is further operable to display a second window included in the second set of windows in response to a window management operation received through one of the touch sensitive display area or the gesture capture area included in the second screen that dismisses the first window.

16. A computer readable medium having stored thereon computer-executable instructions, the computer executable instructions causing a processor to execute a method for controlling a user interface of a device, the computer-executable instructions comprising:

instructions to present a first window by a primary screen of the device, while the device is in an open mode;

instructions to detect receive user input closing the device, thereby placing the device in a closed mode;

in response to the device being placed in the closed mode, instructions to enter a secondary closed mode, wherein the first window is presented by a secondary screen of the device.

17. The computer readable medium of claim 16, further comprising:
instructions to maintain a first set of windows, wherein the first window is maintained in the first set of windows while the device is in the open mode;

instructions to maintain a second set of windows, wherein the first window is maintained in the second set of windows and not in the first set of windows while the device is in the secondary closed mode.

18. The computer readable medium of claim 17, the computer executable instructions further comprising:

instructions to present a second window in the secondary screen of the device in response to a windowing management input instructing that the presentation of the first window by the secondary screen be discontinued, wherein the second window is maintained in the second set of windows.

19. The computer readable medium of claim 18, the computer executable instructions further comprising:

instructions to continue to display the first window in the secondary screen of the device in response to user input returning the device to the open mode.

20. The computer readable medium of claim 19, wherein after the device is returned to the open mode the first window continues to be maintained in the second set of windows.

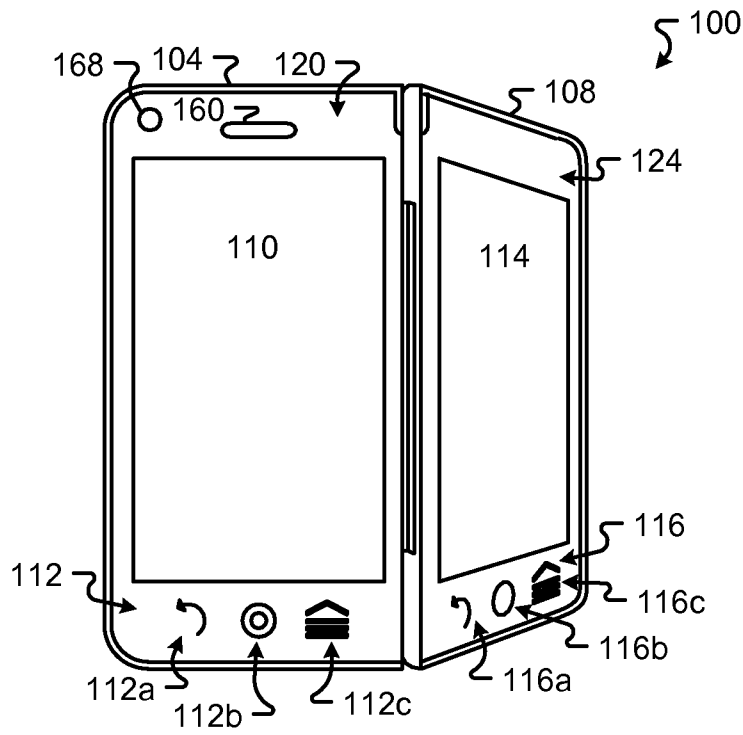

FIG. 1A

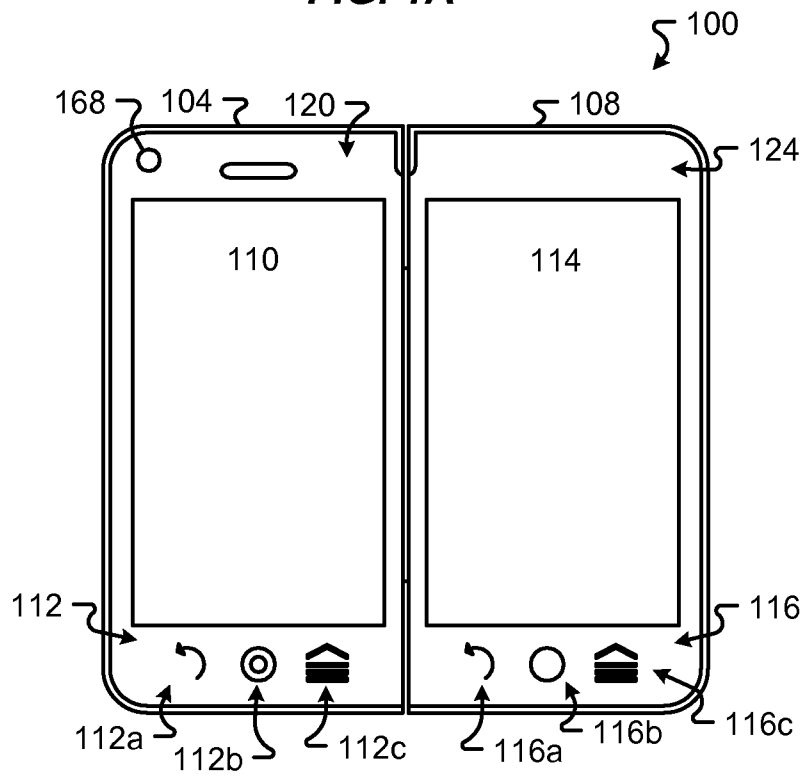
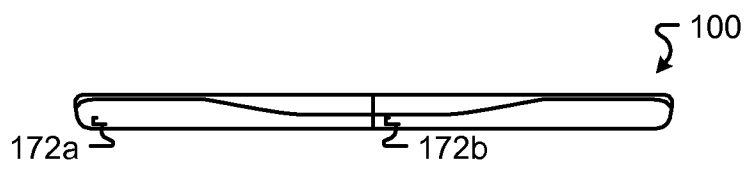
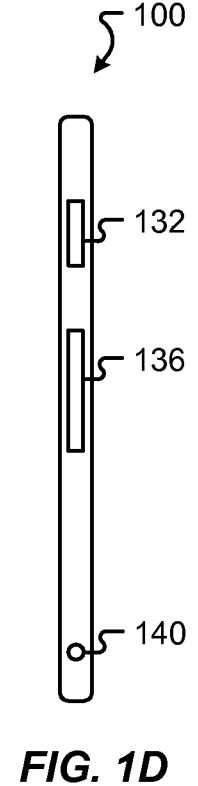
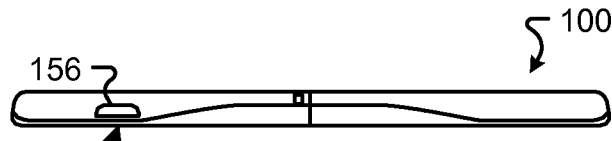
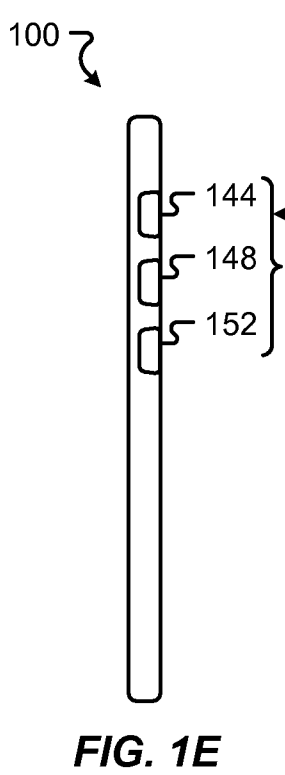
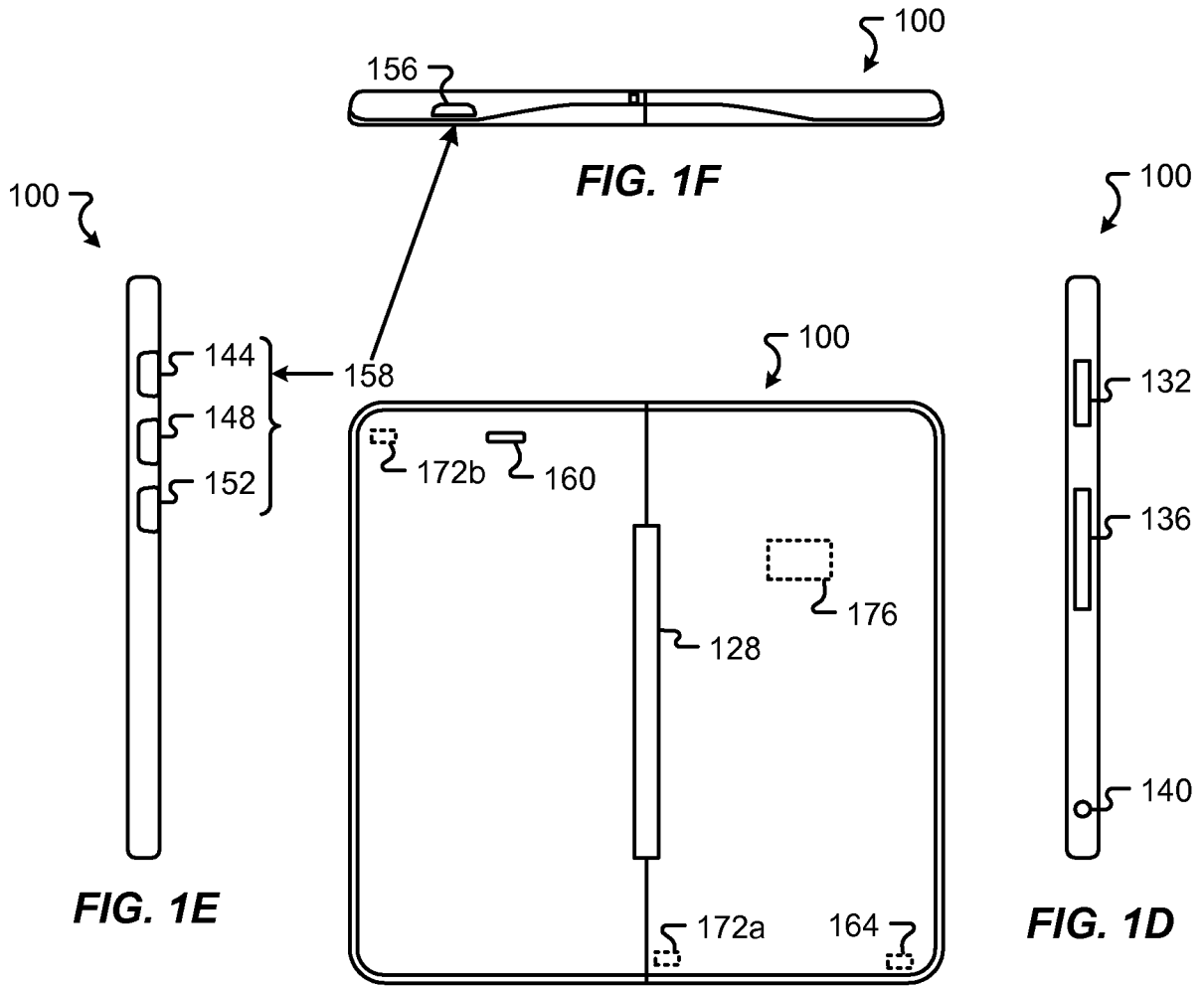

FIG. 1B



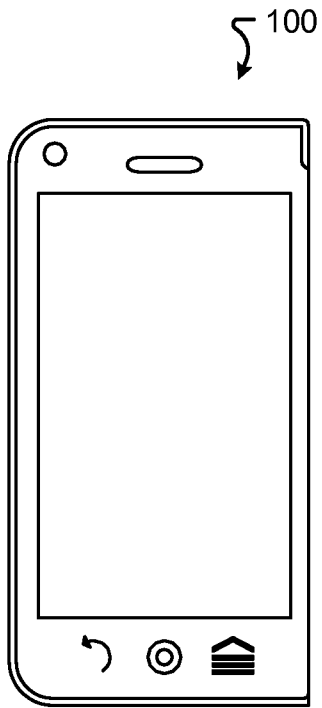

FIG. 1H

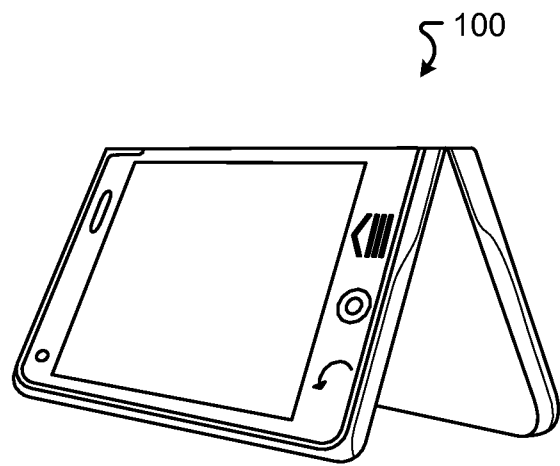

FIG. 1I

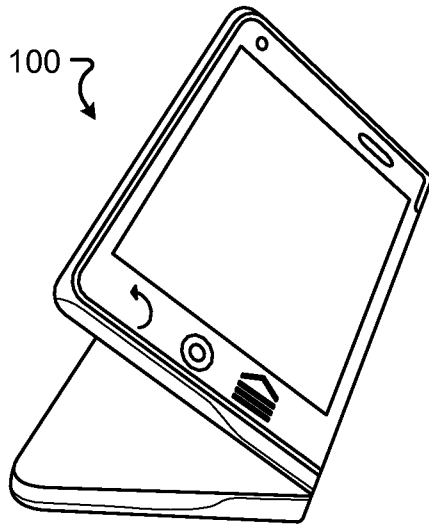

FIG. 1J

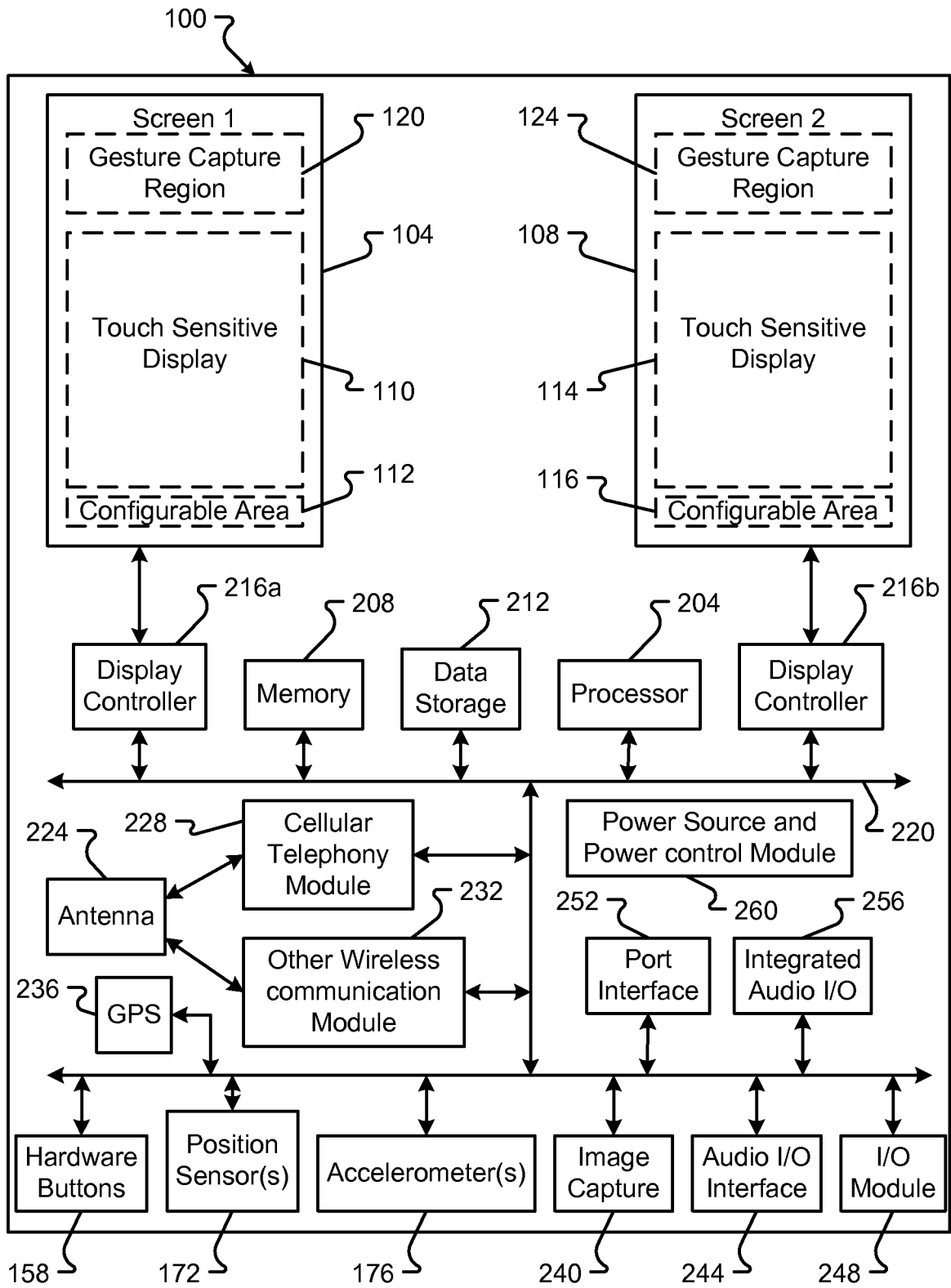

FIG. 2

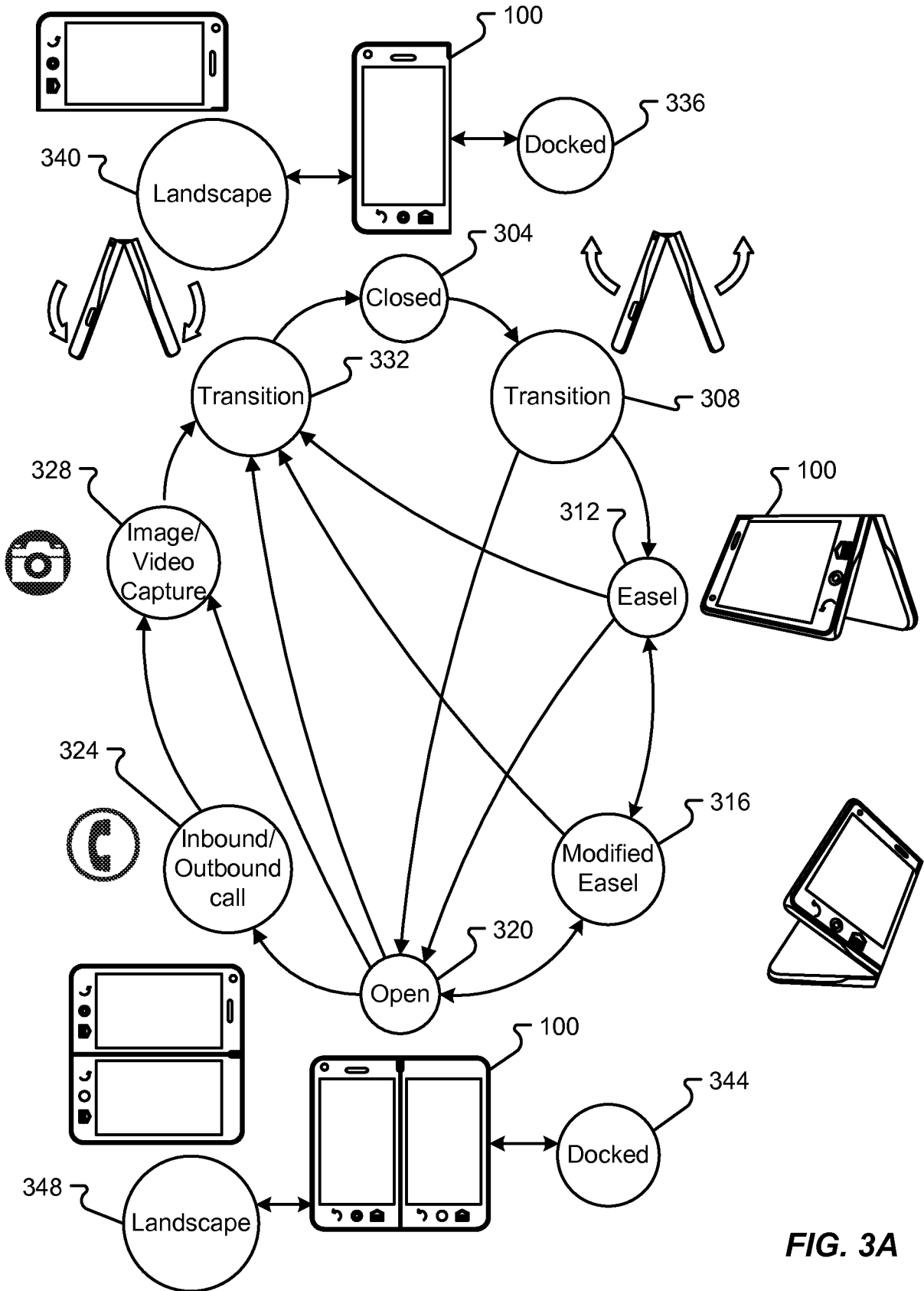

FIG. 3A

	PORTRAIT						LANDSCAPE					
	OPEN	CLOSED	EASEL	MODIFIED EASEL	PHONE	IMAGE / VIDEO	OPEN	CLOSED	EASEL	MODIFIED EASEL	PHONE	IMAGE / VIDEO
P	X	HT	HT	HT	P	I	AT	HAT	HAT	P	I	
O	HT	X	HAT	HAT	P	I	HAT	AT	HAT	P	I	
R	HT	HT	X	X	P	I	HAT	HAT	HAT	P	I	
T	HT	X	HT	HT	X	I	HAT	HAT	HAT	X	I	
R	HT	HT	HT	X	P	X	HAT	HAT	HAT	X	HAT	
I												
A												
T												
L	AT	HAT	HAT	HAT	P	I	X	HT	HAT	P	I	
A	HAT	AT	HAT	HAT	P	I	HT	X	HAT	P	I	
N	HAT	HAT	HAT	HAT	P	I	HT	HT	HAT	P	I	
D	HAT	HAT	HAT	HAT	P	I	HT	HT	HAT	P	I	
S												
C	HAT	HAT	HAT	HAT	HAT	AT	HT	HT	HAT	P	X	
A												
P												
E												
DOCKED												

Key:
 H - Hall Effect Sensor(s)
 a - accelerometer(s)
 T - Timer
 P - communications Trigger
 I - Image / Video capture Request

FIG. 3B

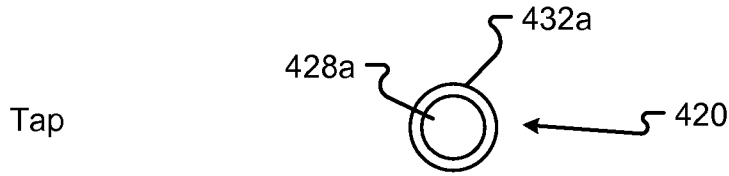

FIG. 4A

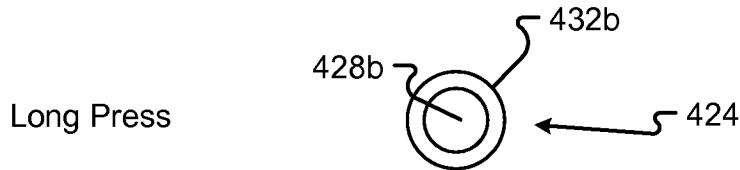

FIG. 4B

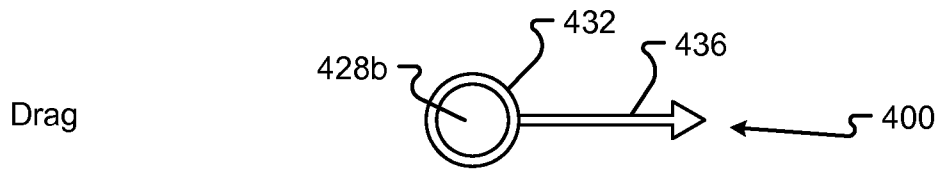

FIG. 4C

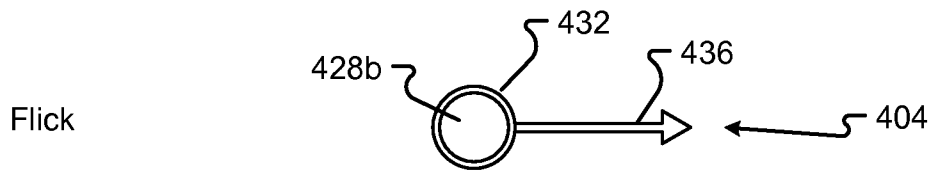

FIG. 4D

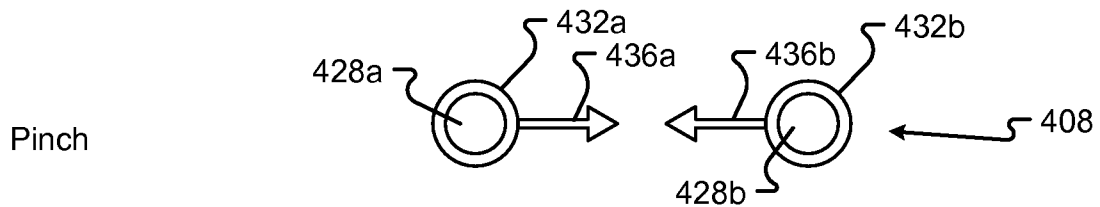

FIG. 4E

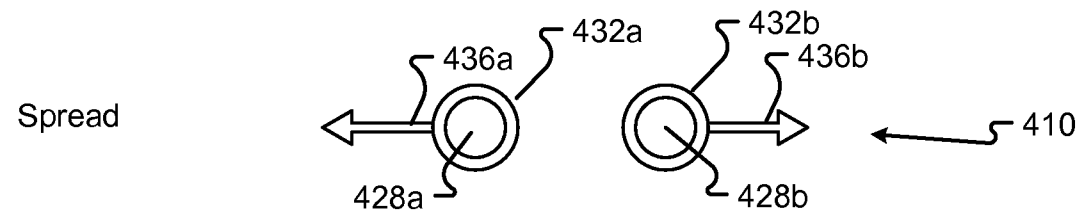

FIG. 4F

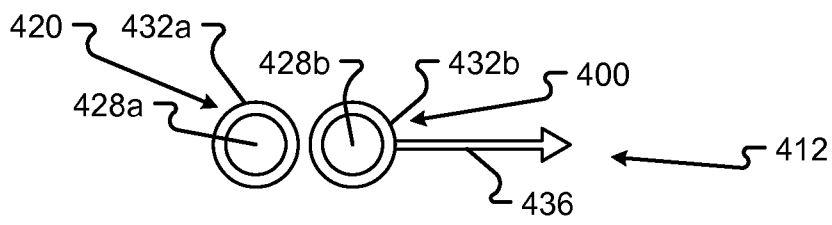

FIG. 4G

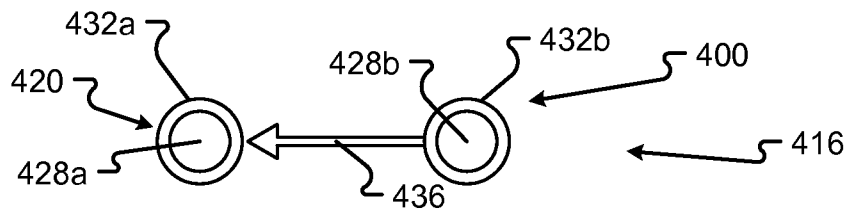

FIG. 4H

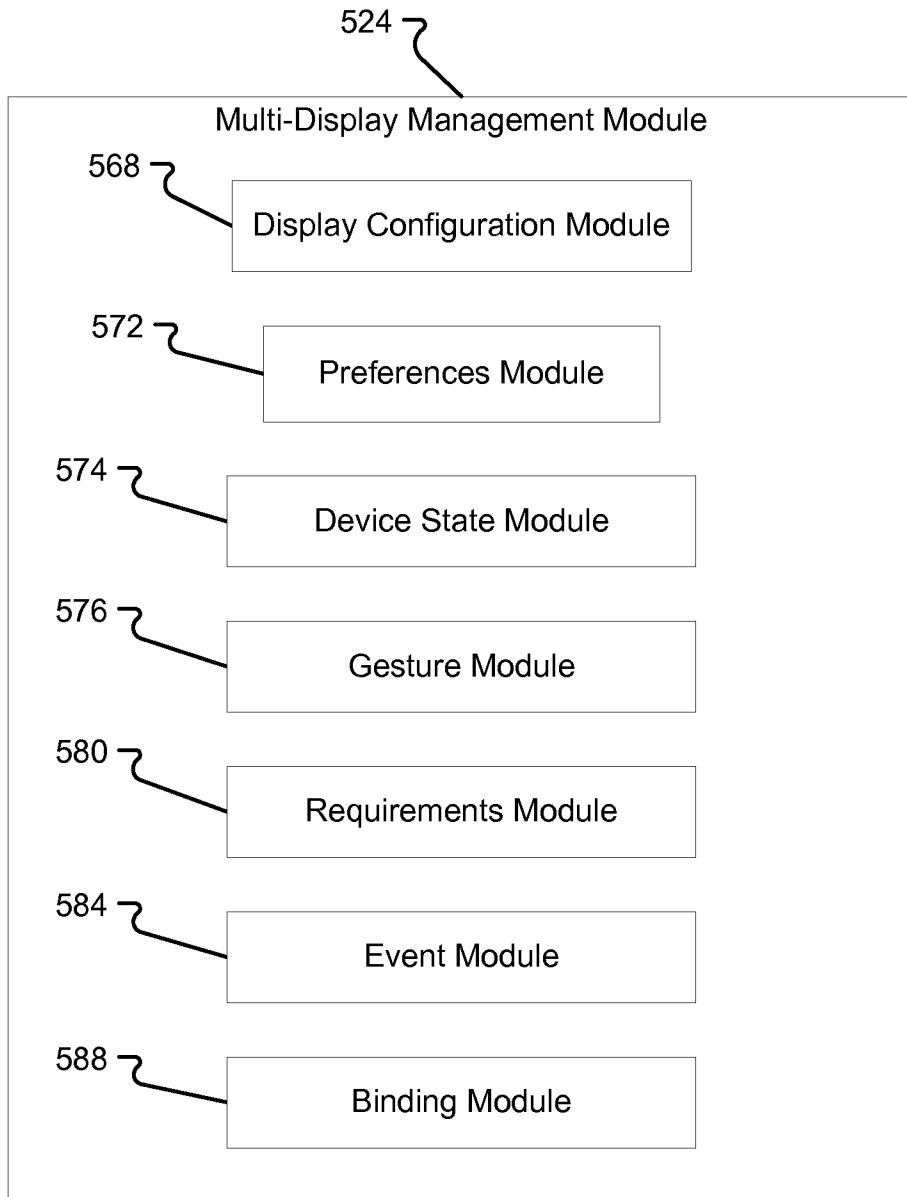

FIG. 5B

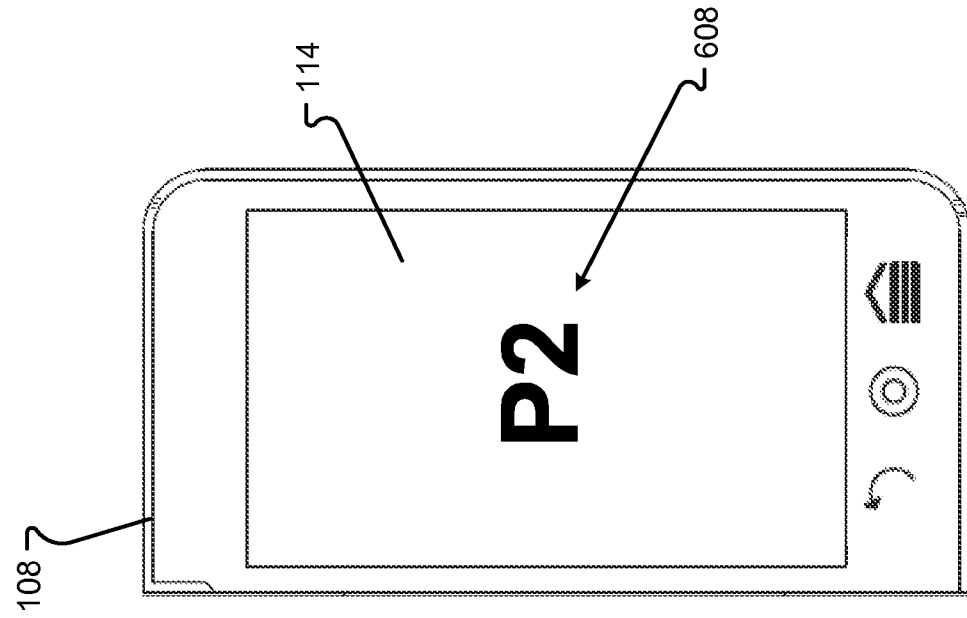

FIG. 6A

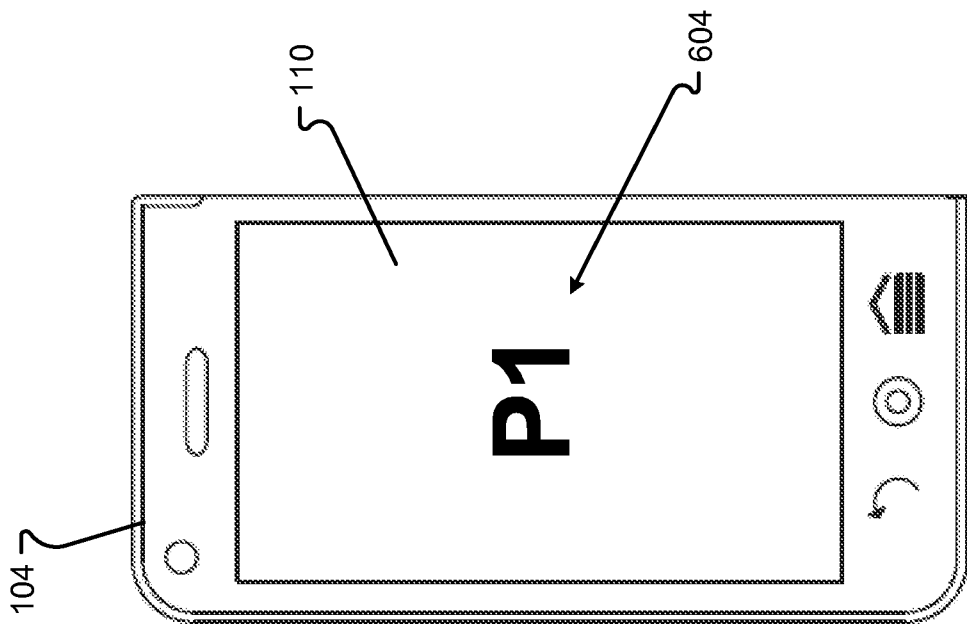

FIG. 6B

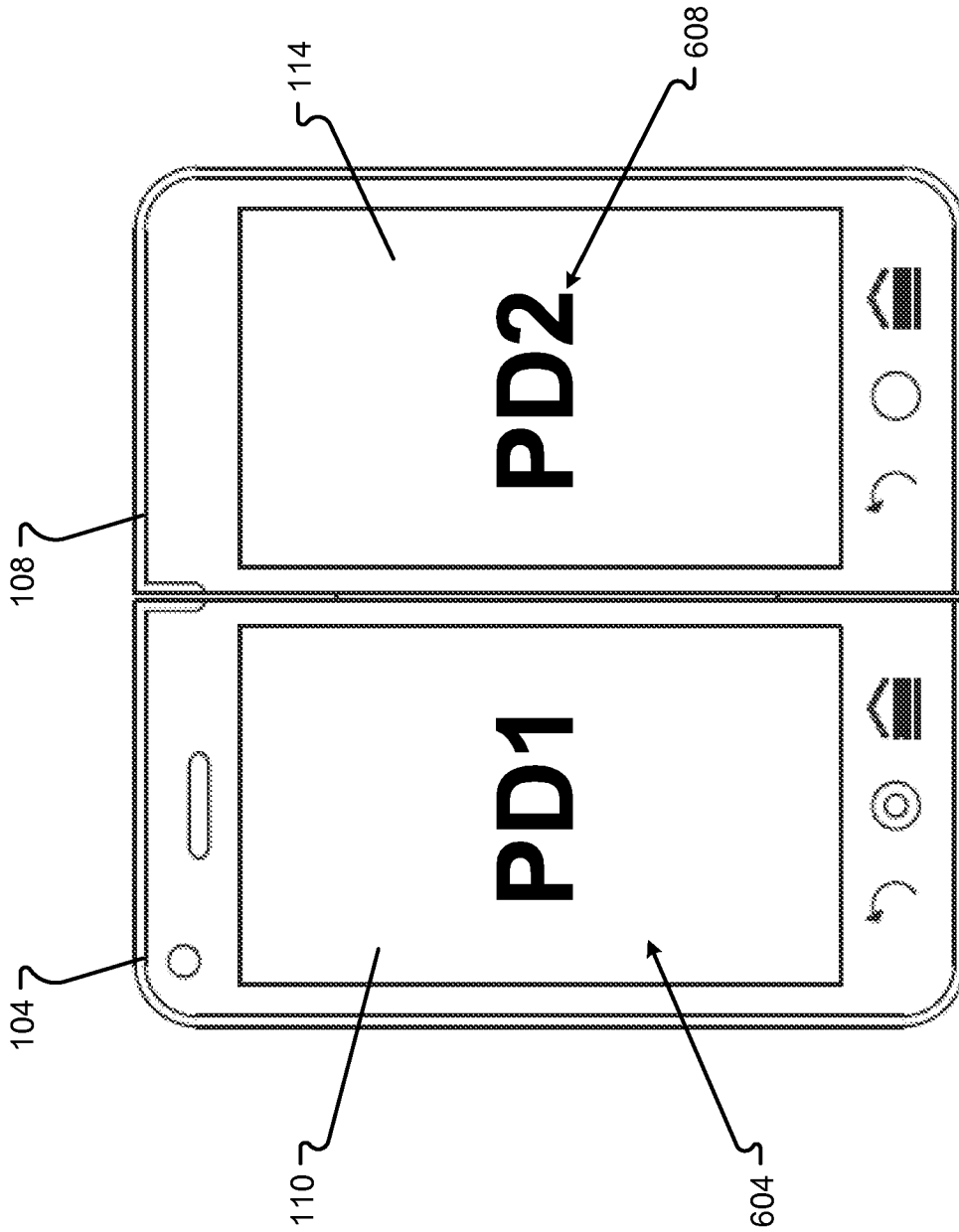

FIG. 6C

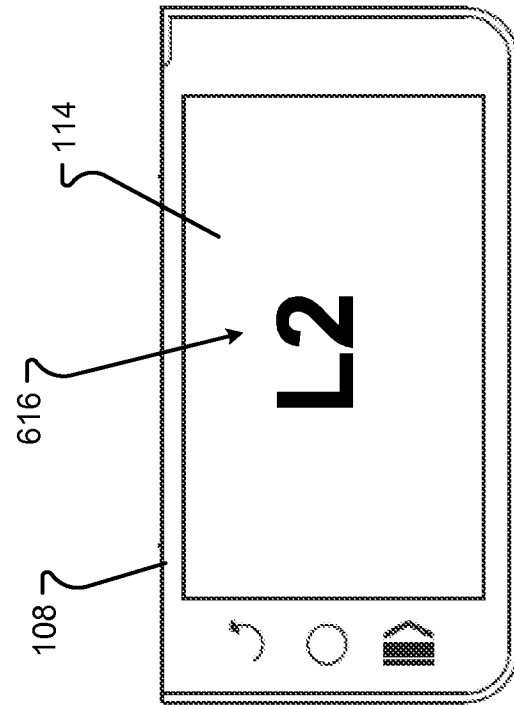

FIG. 6E

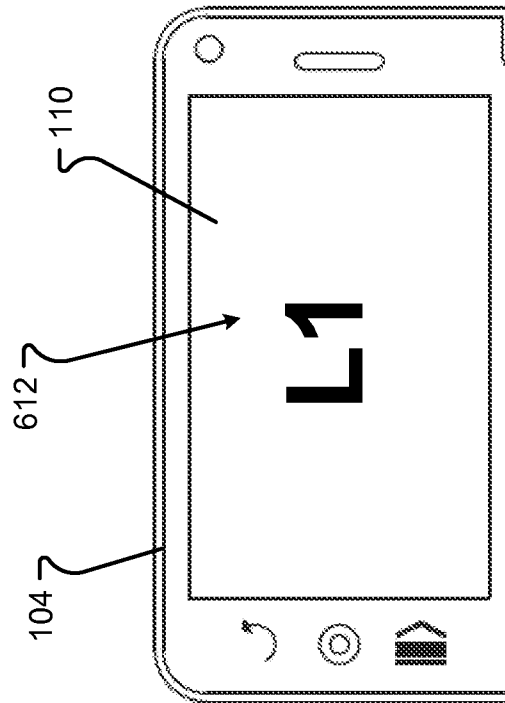

FIG. 6D

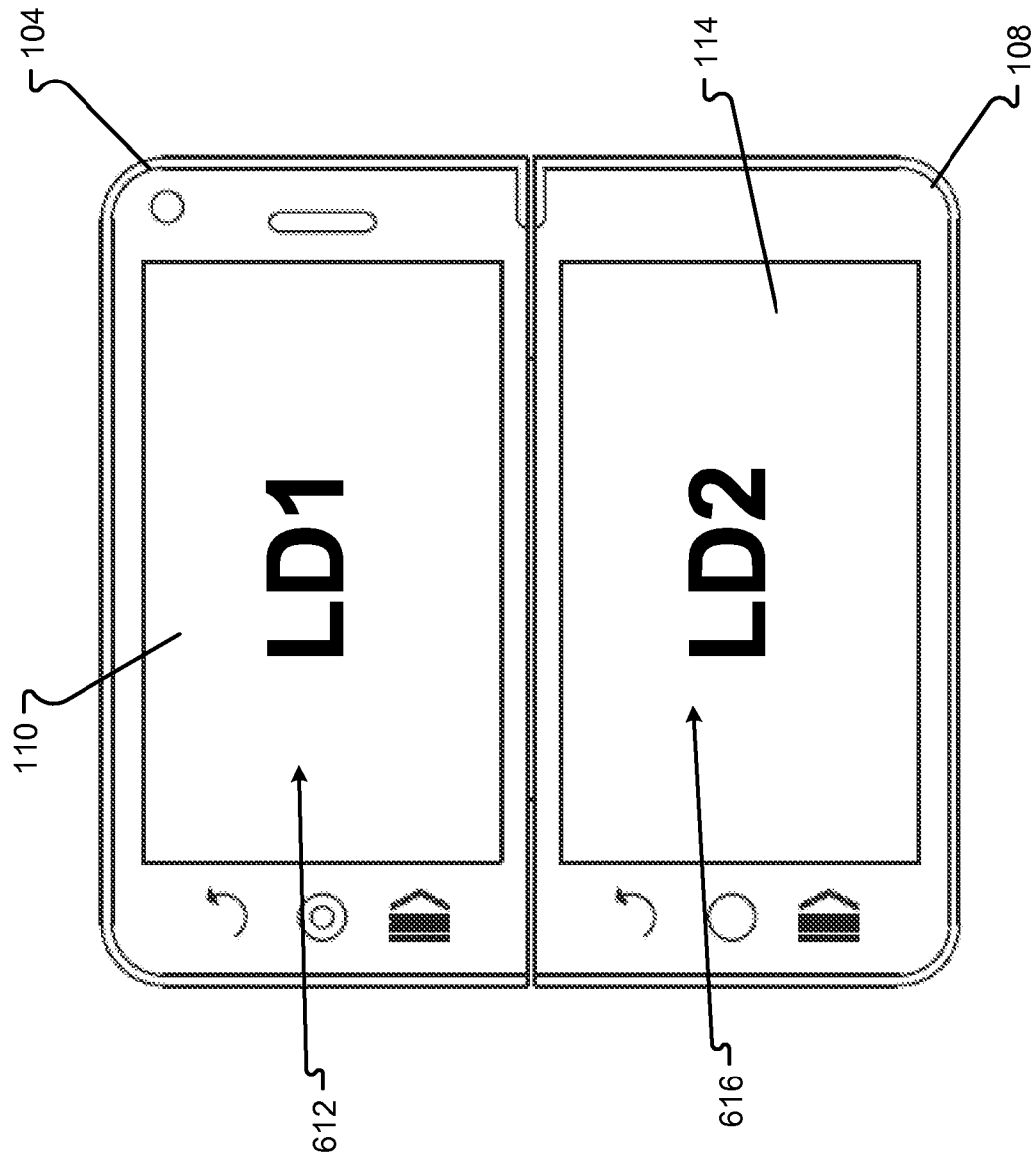

FIG. 6F

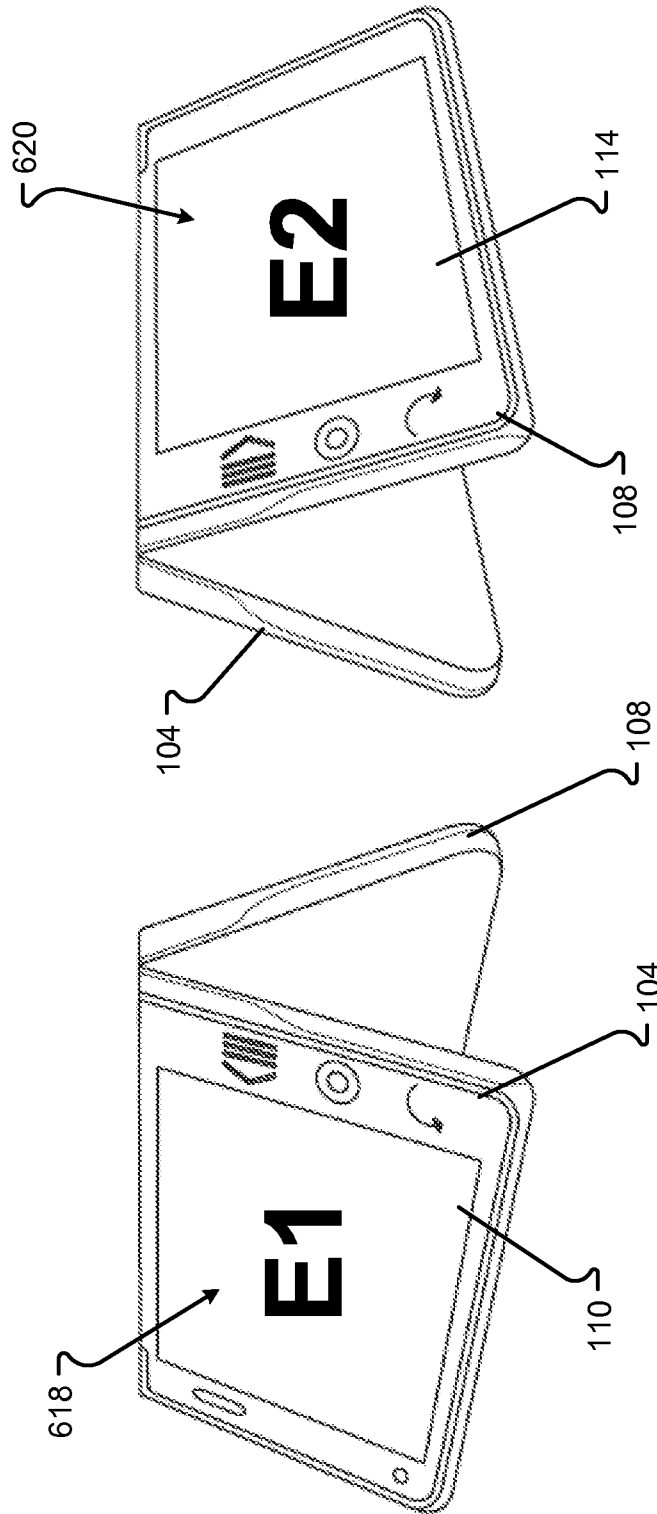
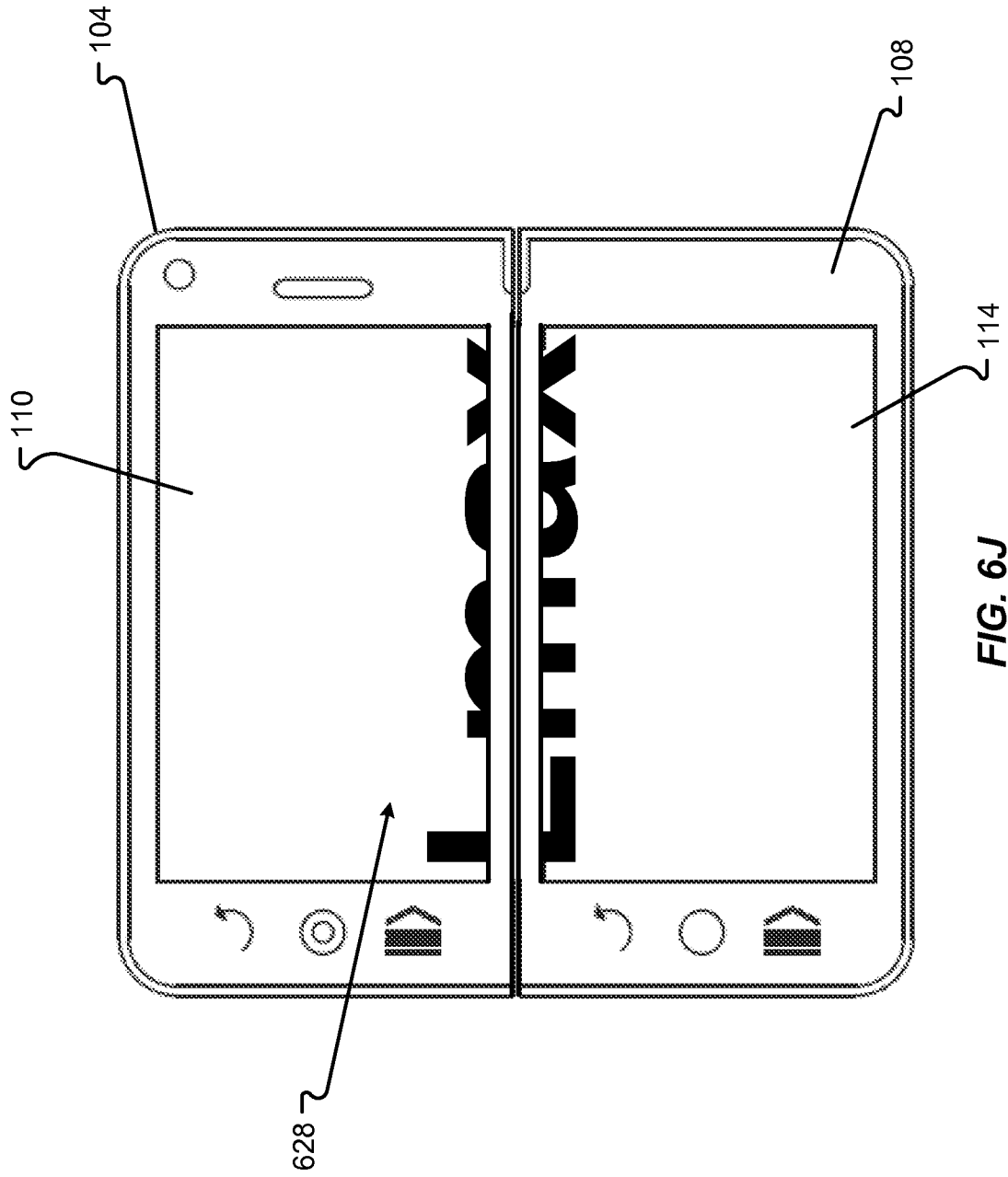

FIG. 6H

FIG. 6G



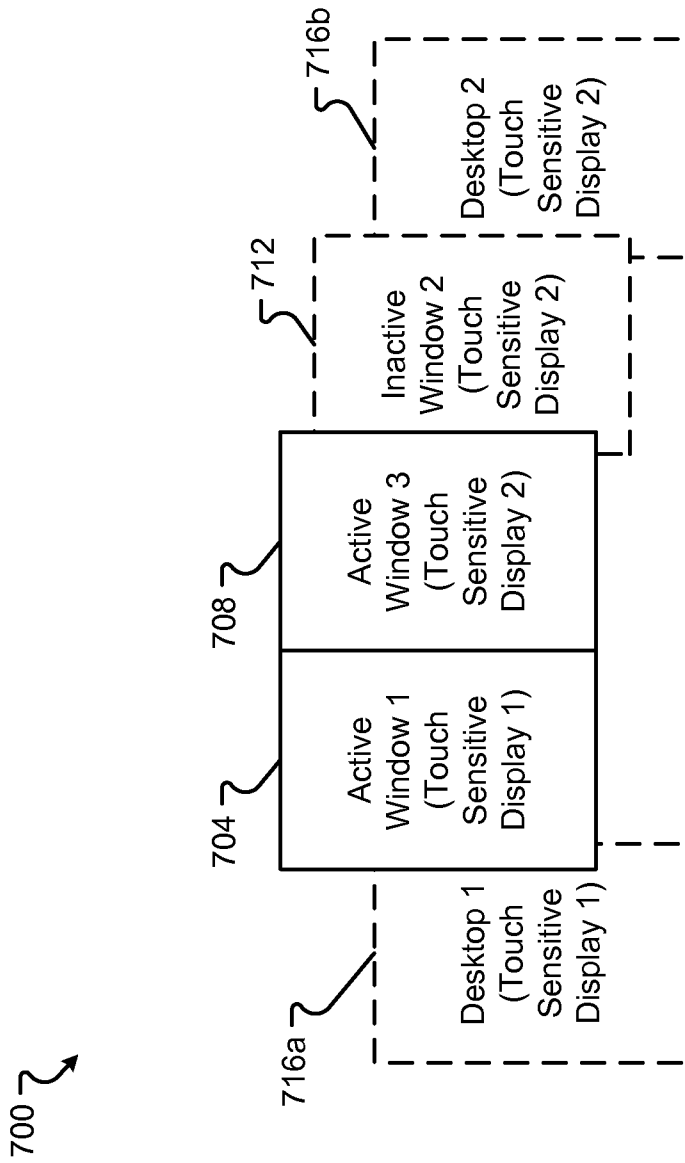

FIG. 7A

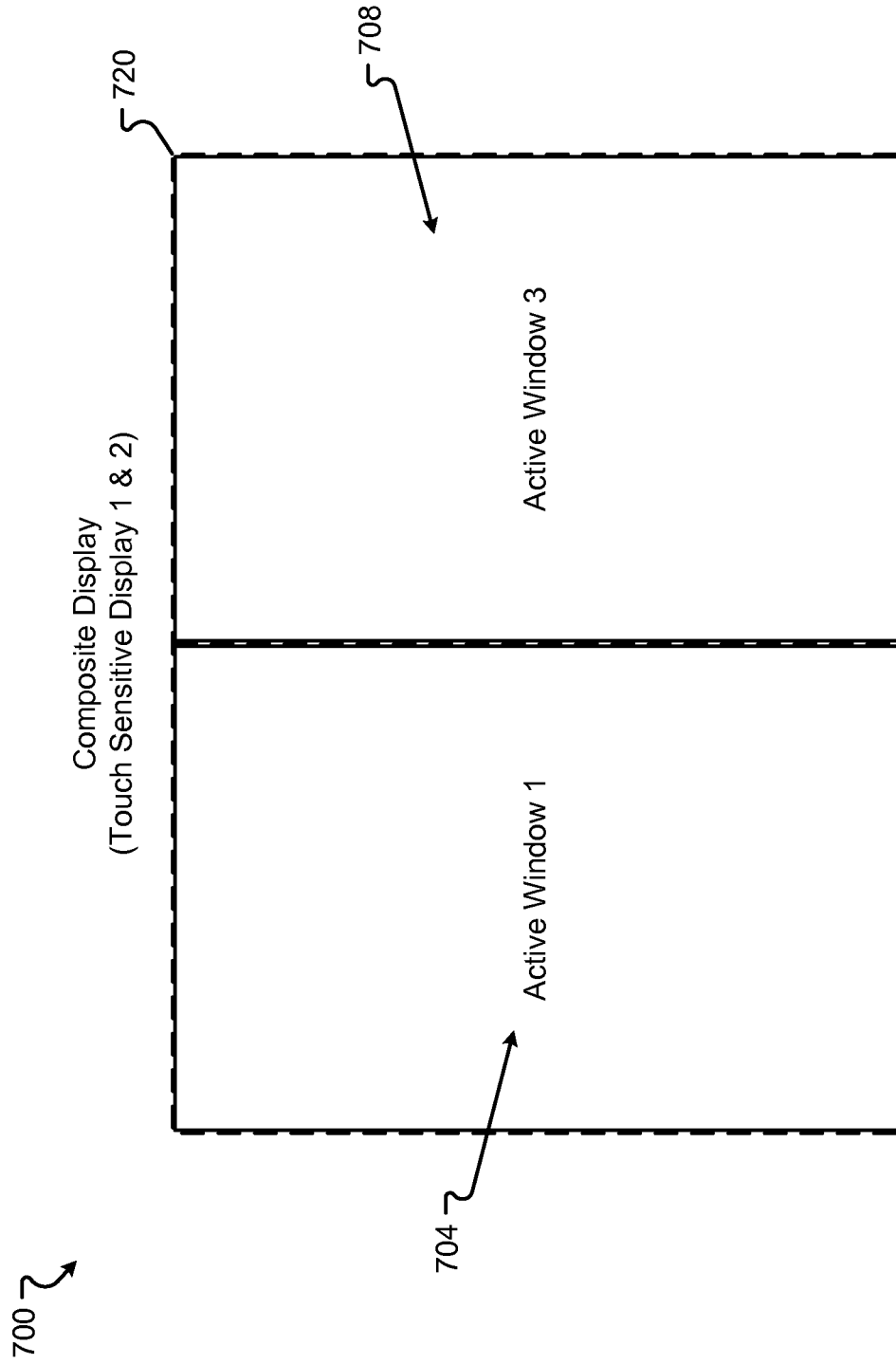

FIG. 7B

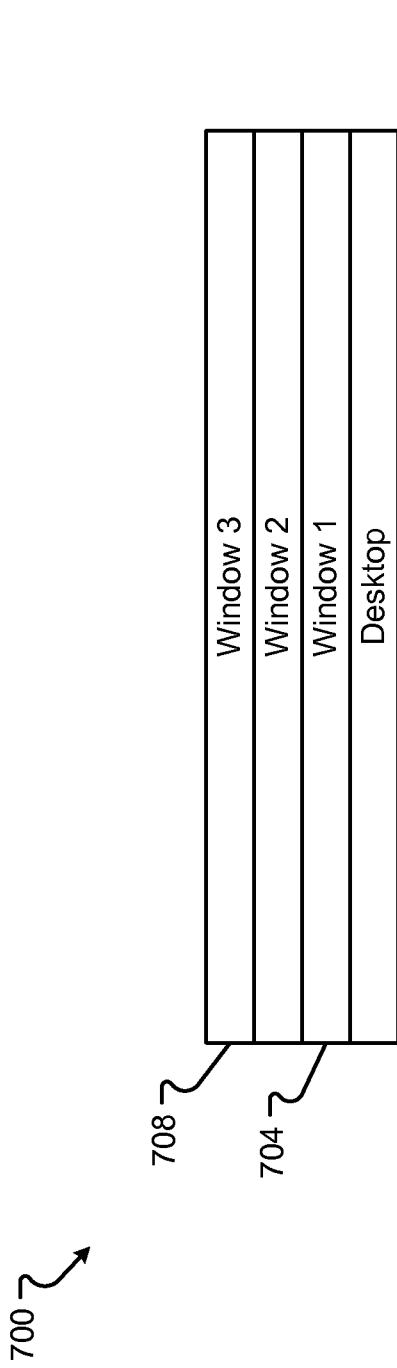

FIG. 7C

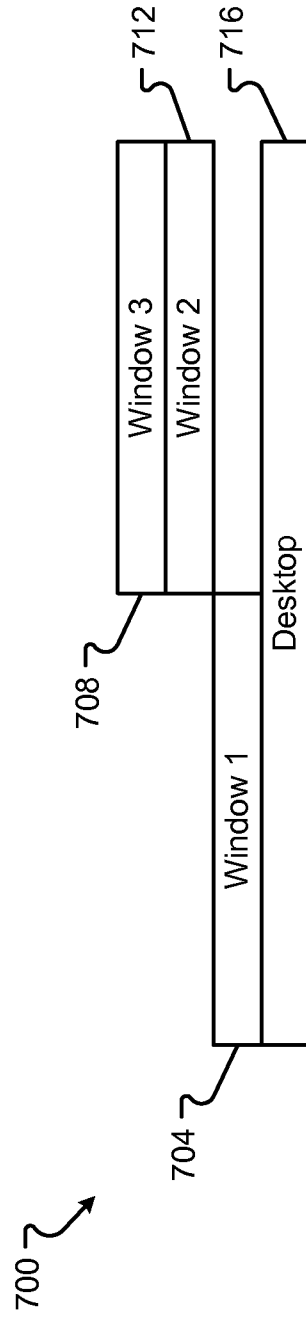

FIG. 7D

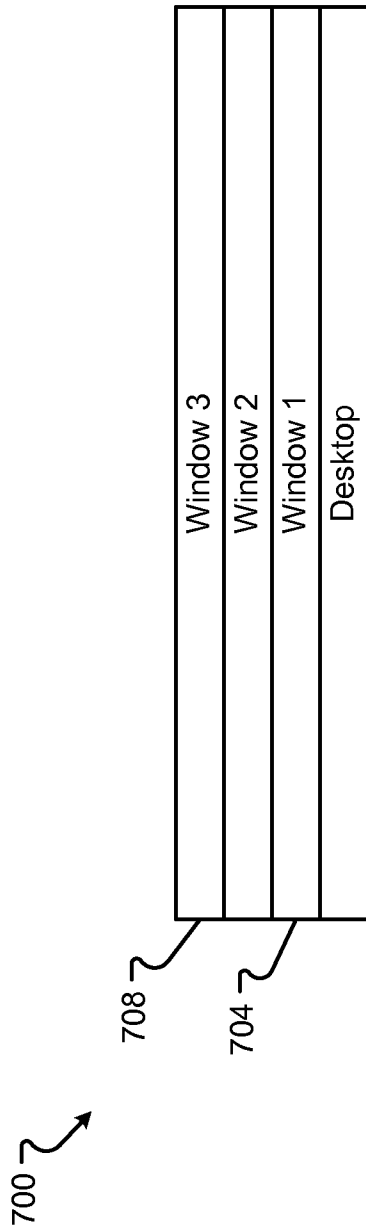

FIG. 7E

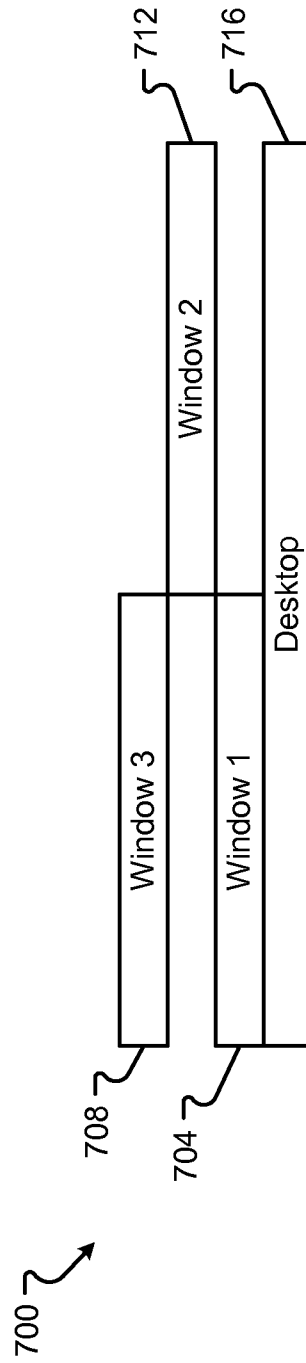

FIG. 7F

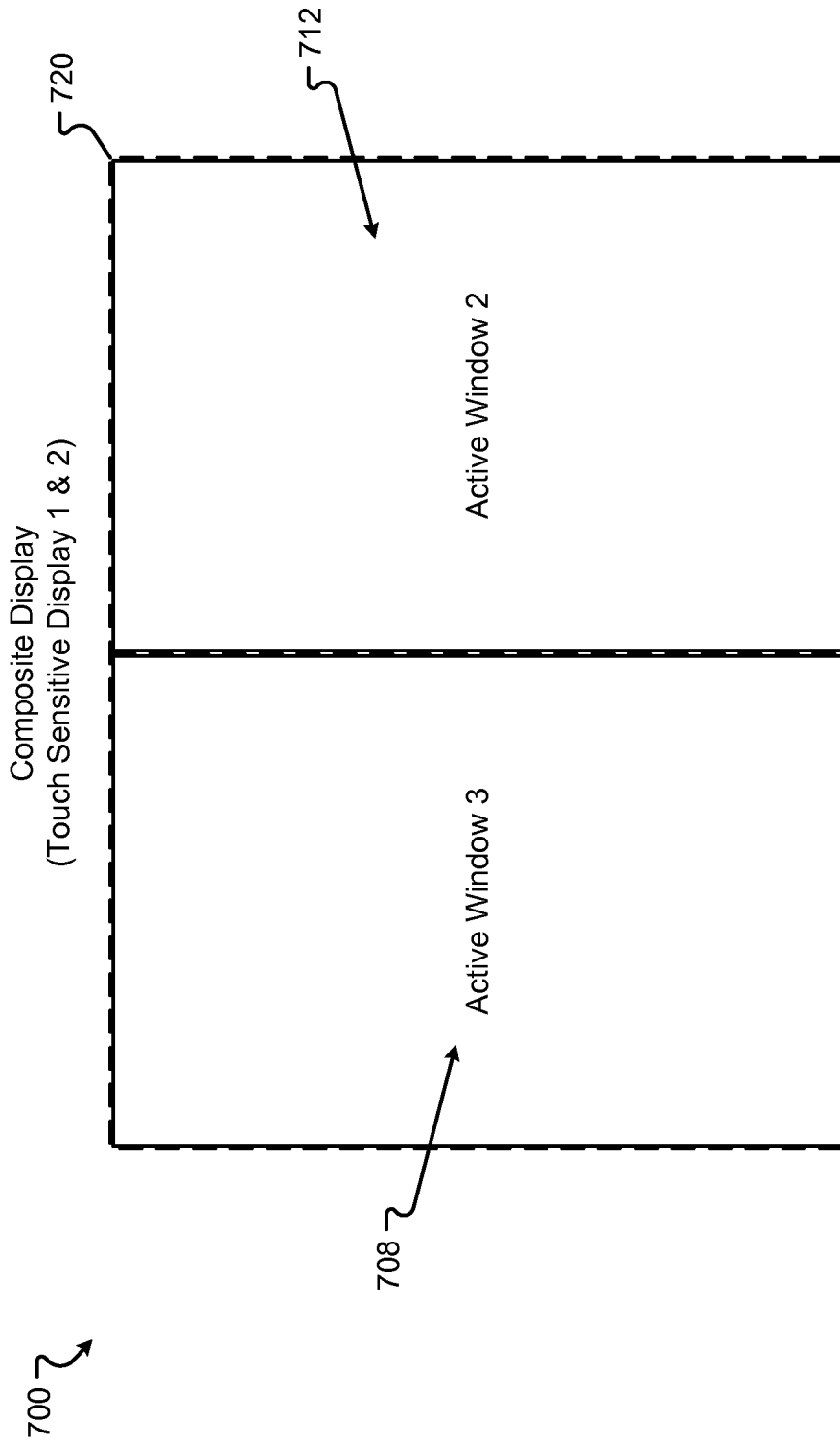

FIG. 7G

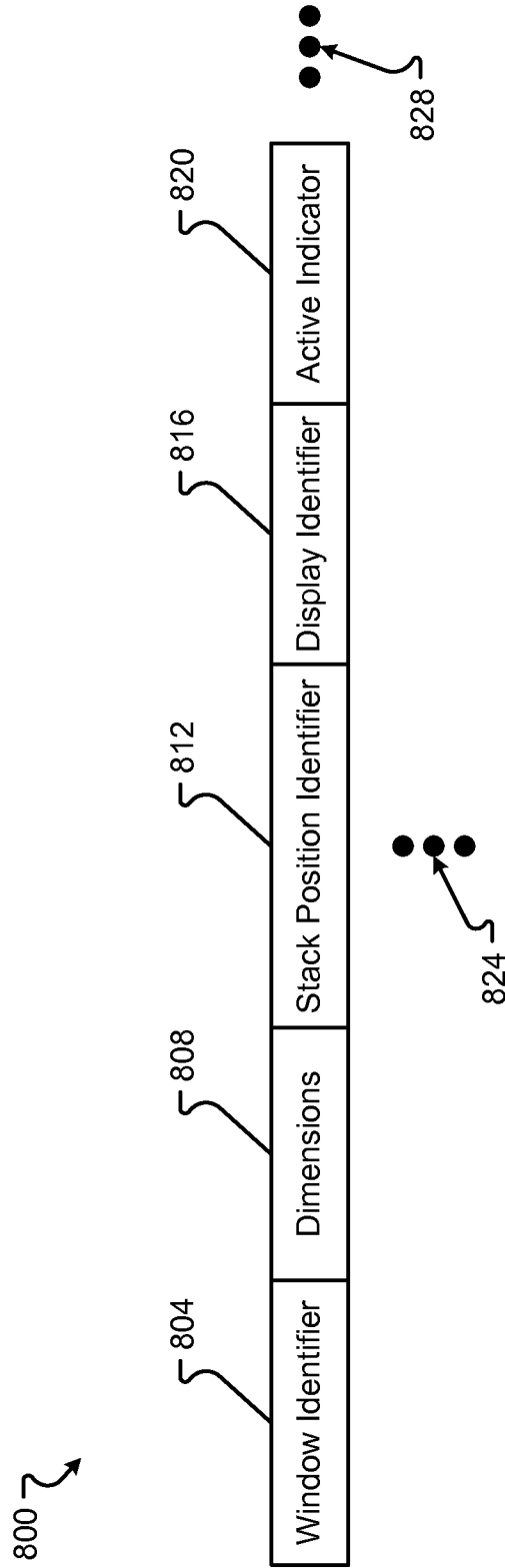

FIG. 8

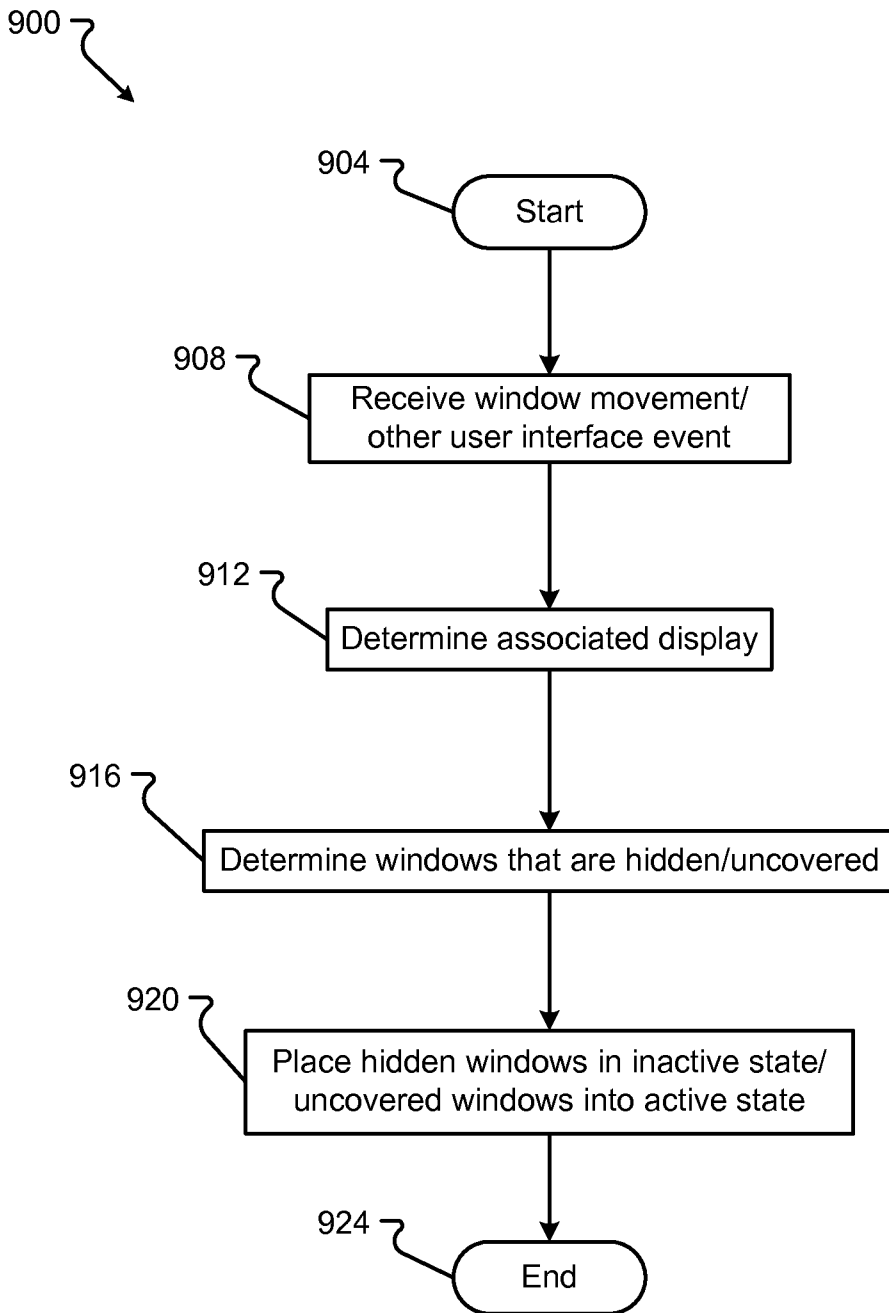

FIG. 9

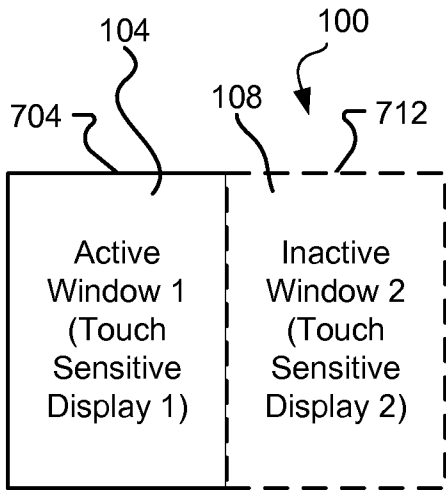

FIG. 10A

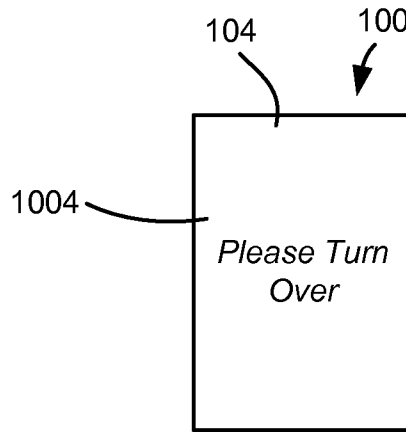

FIG. 10B

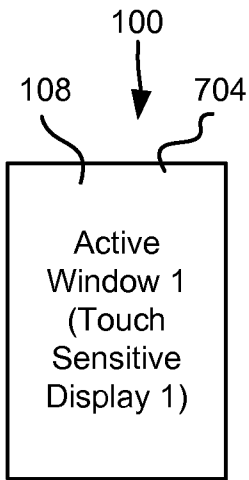

FIG. 10C

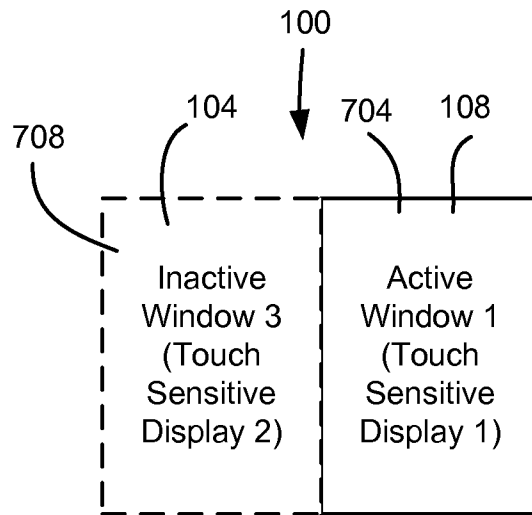

FIG. 10D

SHEET 26/26

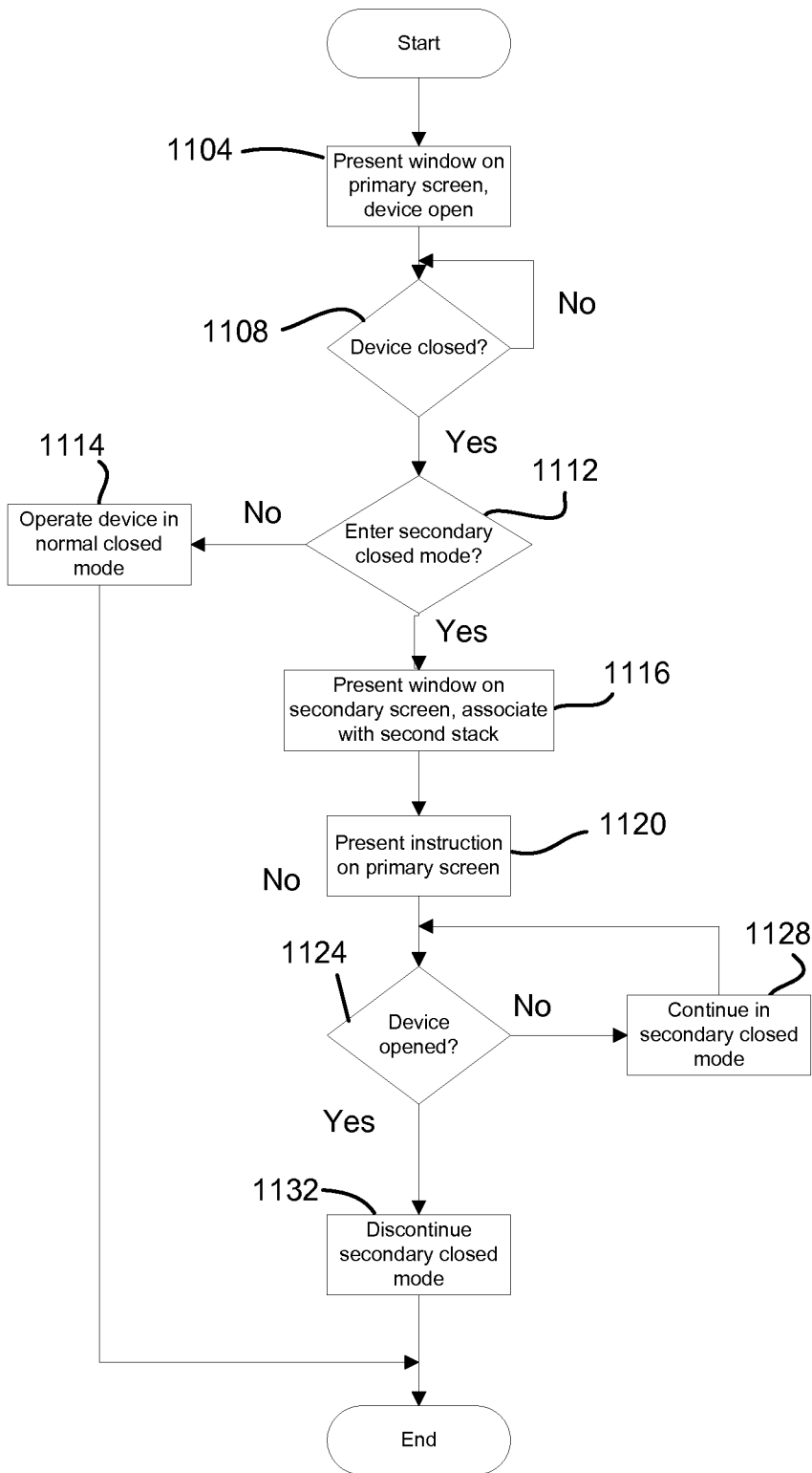

Fig. 11