



US0D1002467S

(12) **United States Design Patent**
Manzoni

(10) **Patent No.:** **US D1,002,467 S**

(45) **Date of Patent:** **** Oct. 24, 2023**

(54) **INTERIOR FOR A VEHICLE**

- (71) Applicant: **Ferrari S.p.A.**, Modena (IT)
- (72) Inventor: **Flavio Manzoni**, Modena (IT)
- (73) Assignee: **FERRARI S.p.A.**, Modena (IT)
- (**) Term: **15 Years**

- (21) Appl. No.: **29/838,022**
- (22) Filed: **May 10, 2022**

(30) **Foreign Application Priority Data**

Nov. 12, 2021 (WO) DM/217524

(51) **LOC (14) Cl.** **06-01**

(52) **U.S. Cl.**
USPC **D12/195**

(58) **Field of Classification Search**
USPC D6/356, 716.7; D12/82, 86, 90, 92, 190,
D12/193, 195, 196, 414, 416; D10/46;
D15/17, 28
CPC . B60J 5/04; B62D 13/02; B62D 31/00; B62D
31/003
See application file for complete search history.

(56) **References Cited**

U.S. PATENT DOCUMENTS

D630,987	S *	1/2011	Edwards	D12/195
D788,000	S *	5/2017	LeFranc	D12/195
D848,332	S *	5/2019	Tomasson	D12/195
D849,625	S *	5/2019	Yamamoto	D12/195
D889,149	S *	7/2020	Bell	B62D 31/003
					D6/356
D917,907	S *	5/2021	Mignot	D6/356
D934,782	S *	11/2021	Lin	D12/345
D938,175	S *	12/2021	Wu	D6/356
D974,061	S *	1/2023	Kentley-Klay	D6/356
D990,906	S *	7/2023	Persson	D6/356
2018/0304779	A1 *	10/2018	Fitzpatrick	B62D 31/003

OTHER PUBLICATIONS

Carscoops.com, Carlex Design Finishes Ferrari 458 Spider Project, published Mar. 6, 2016 [retrieved Jul. 24, 2023]. Retrieved from the internet<<https://www.carscoops.com/2016/03/carlex-design-finishes-ferrari-458/>> (Year: 2016).*

Car Magazine.co.uk, New Ferrari Daytona SP3 revealed: behold Maranello's V12, published Nov. 20, 2021 [retrieved Jul. 24, 2023]. Retrieved from the internet<<https://www.carmagazine.co.uk/car-news/first-official-pictures/ferrari/daytona-sp3/>> (Year: 2021).*

Carbuzz.com, Sold Out: \$2.25 Million Ferrari Daytona SP3, published Nov. 21, 2021 [retrieved Jul. 24, 2023]. Retrieved from the internet<<https://carbuzz.com/news/sold-out-2-25-million-ferrari-daytona-sp3>> (Year: 2021).*

* cited by examiner

Primary Examiner — Joseph Kukella

Assistant Examiner — Lavon M. Amerson

(74) *Attorney, Agent, or Firm* — Cowan, Liebowitz & Latman, P.C.; Anastasia Zhadina

(57) **CLAIM**

The ornamental design for an interior for a vehicle, as shown and described.

DESCRIPTION

FIG. 1 is a front perspective view of the interior for a vehicle showing my design;

FIG. 2 is a front elevation view thereof;

FIG. 3 is a right side view thereof;

FIG. 4 is a rear elevation view thereof;

FIG. 5 is a left side view thereof, with the right and left side views being opposite to one another;

FIG. 6 is a top plan view thereof; and,

FIG. 7 is a bottom plan view thereof.

Portions of the interior for a vehicle shown in broken lines form no part of the claimed design.

1 Claim, 7 Drawing Sheets

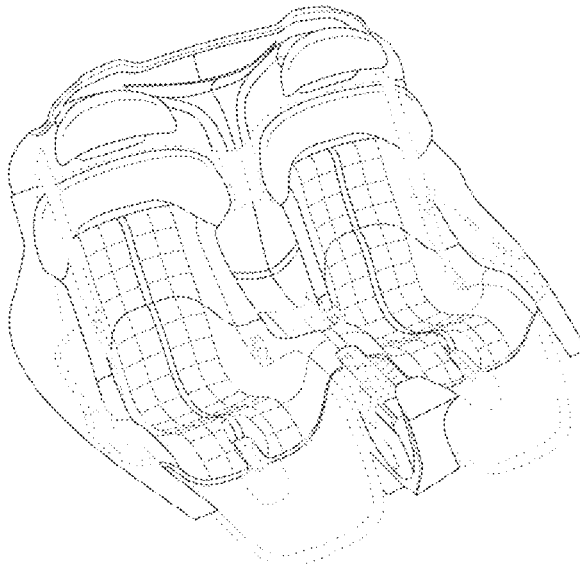

FIG. 1

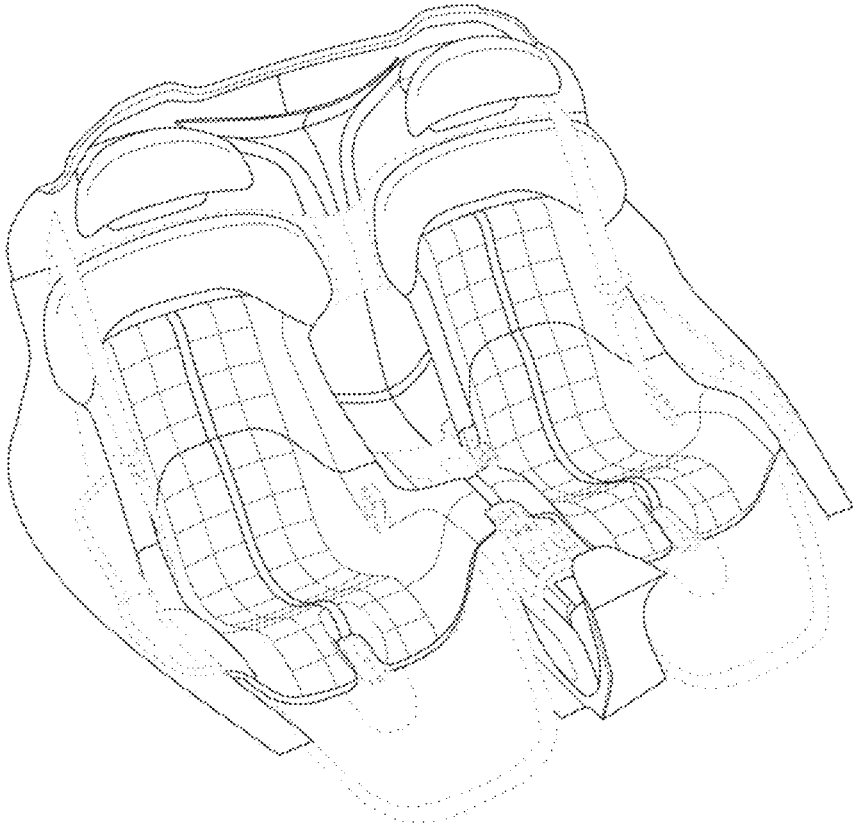

FIG. 2

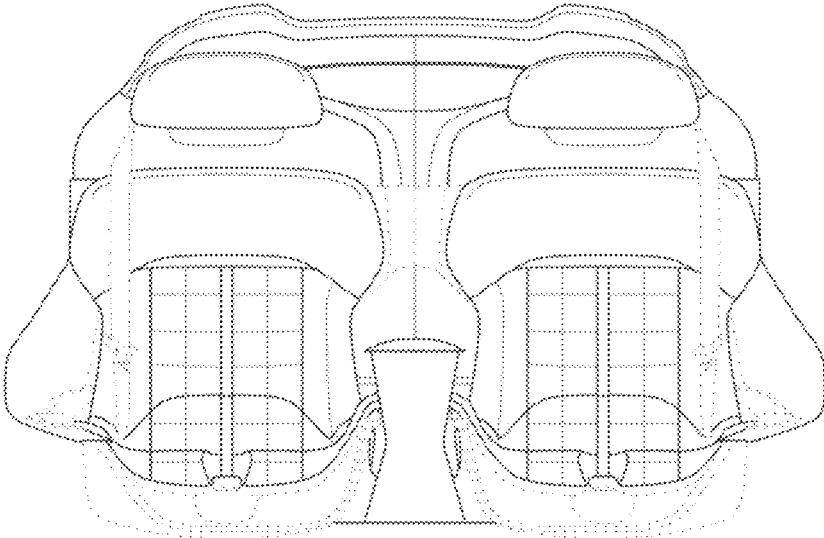

FIG. 3

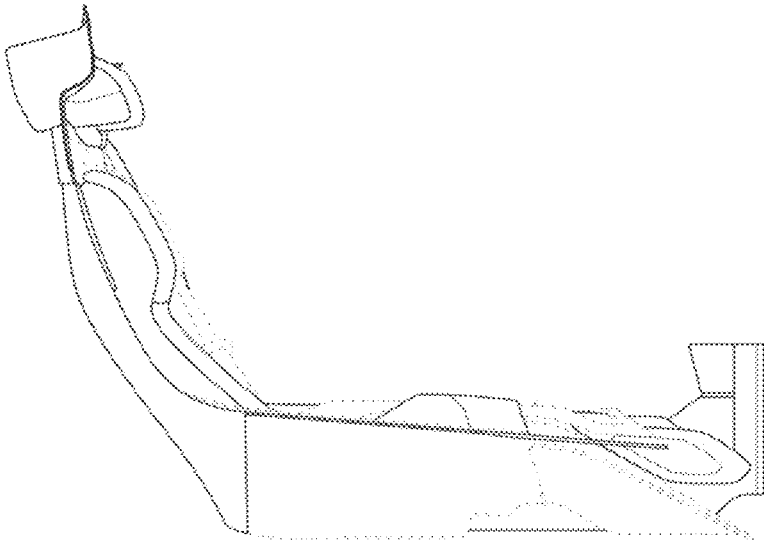

FIG. 4

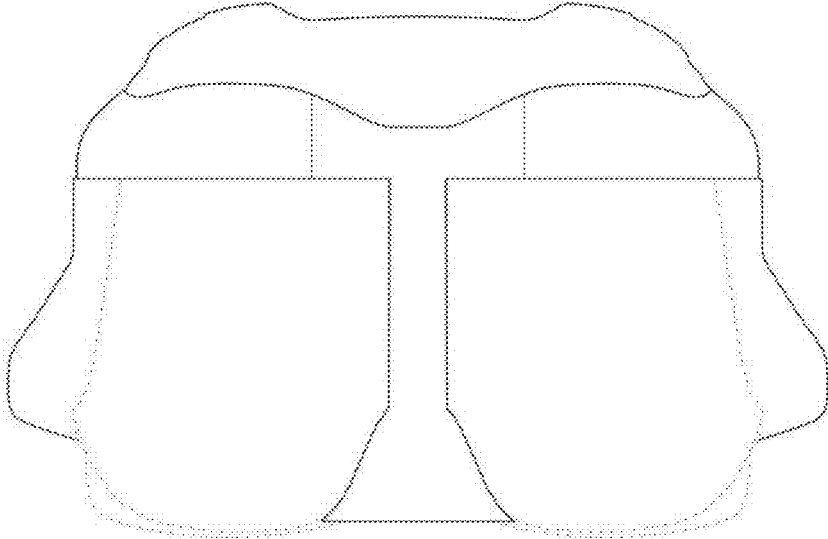

FIG. 5

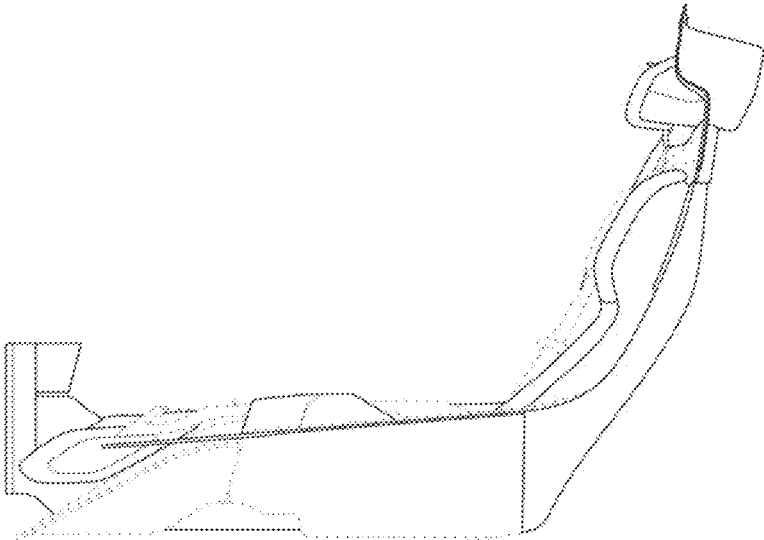

FIG. 6

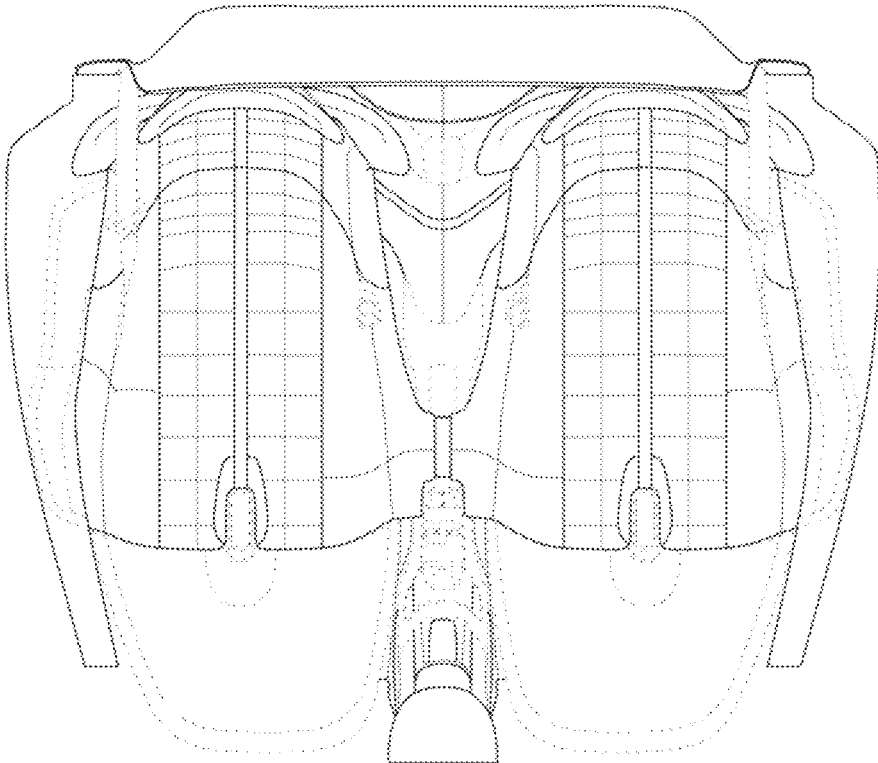

FIG. 7

