

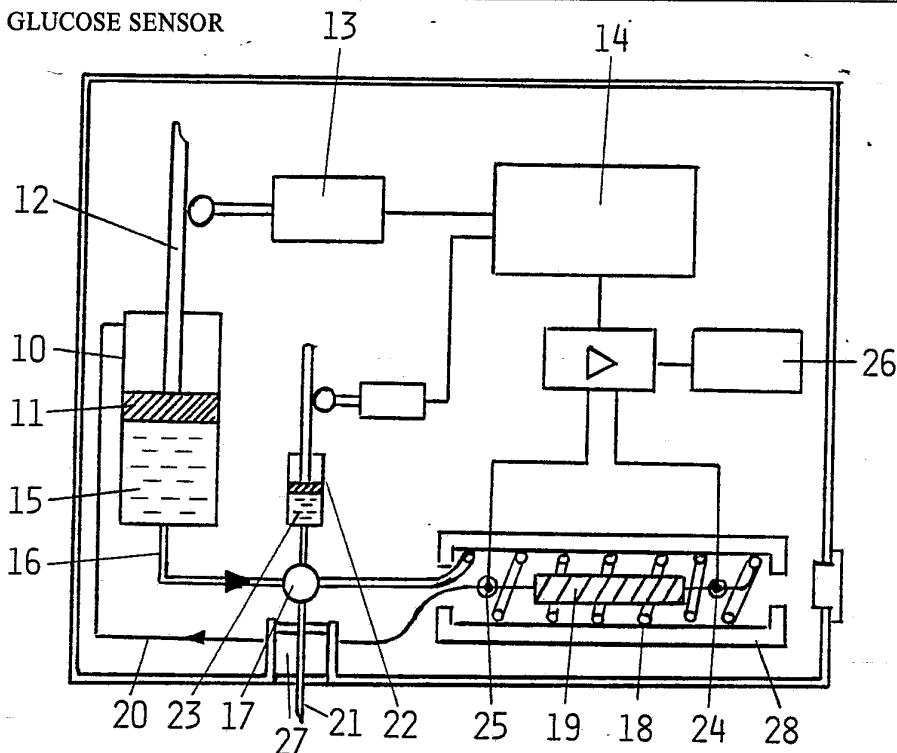

INTERNATIONAL APPLICATION PUBLISHED UNDER THE PATENT COOPERATION TREATY (PCT)

<p>(51) International Patent Classification ⁵ : G01N 25/48, C12M 1/40</p>	<p>A1</p>	<p>(11) International Publication Number: WO 93/01489 (43) International Publication Date: 21 January 1993 (21.01.93)</p>
<p>(21) International Application Number: PCT/DK92/00213 (22) International Filing Date: 2 July 1992 (02.07.92) (30) Priority data: 1345/91 12 July 1991 (12.07.91) DK 1646/91 27 September 1991 (27.09.91) DK (71) Applicant (for all designated States except US): NOVO NORDISK A/S [DK/DK]; Novo Allé, DK-2880 Bagsværd (DK). (72) Inventor; and (75) Inventor/Applicant (for US only) : DANIELSSON, Bengt [SE/SE]; Blomstergården, S-222 48 Lund (SE). (74) Common Representative: NOVO NORDISK A/S; Patent Department, EiT, Novo Allé, DK-2880 Bagsværd (DK).</p>		<p>(81) Designated States: AU, BB, BG, BR, CA, CS, FI, HU, JP, KP, KR, LK, MG, MN, MW, NO, PL, RO, RU, SD, US, European patent (AT, BE, CH, DE, DK, ES, FR, GB, GR, IT, LU, MC, NL, SE), OAPI patent (BF, BJ, CF, CG, CI, CM, GA, GN, ML, MR, SN, TD, TG).</p> <p>Published <i>With international search report.</i></p>

(54) Title: PORTABLE GLUCOSE SENSOR



(57) Abstract

A portable device for measuring the glucose concentration in a whole blood sample by measuring the heat production when the glucose is decomposed in the presence of an enzyme. The device comprises a micro enzyme calorimeter having a reactor (19) with a superporous carrier on the surface of which an enzyme is immobilized, and temperature transducers (25, 28) measuring the temperatures of the sample before and after its passage through the reactor. A narrowly wound helical tube (18) through which the sample passes surrounds the reactor (19) constituting a heat barrier. Further, the device comprises a reservoir (15) for a buffer used for diluting the sample and rinsing the reactor after each measuring. A microcomputer (14) controls the passage of the sample and the buffer through the reactor (19) and calculates the glucose concentration on the basis of the heating measured.

FOR THE PURPOSES OF INFORMATION ONLY

Codes used to identify States party to the PCT on the front pages of pamphlets publishing international applications under the PCT.

AT	Austria	FI	Finland	ML	Mali
AU	Australia	FR	France	MN	Mongolia
BB	Barbados	GA	Gabon	MR	Mauritania
BE	Belgium	GB	United Kingdom	MW	Malawi
BF	Burkina Faso	GN	Guinea	NL	Netherlands
BG	Bulgaria	GR	Greece	NO	Norway
BJ	Benin	HU	Hungary	PL	Poland
BR	Brazil	IE	Ireland	RO	Romania
CA	Canada	IT	Italy	RU	Russian Federation
CF	Central African Republic	JP	Japan	SD	Sudan
CG	Congo	KP	Democratic People's Republic of Korea	SE	Sweden
CH	Switzerland	KR	Republic of Korea	SN	Senegal
CI	Côte d'Ivoire	LI	Liechtenstein	SU	Soviet Union
CM	Cameroon	LK	Sri Lanka	TD	Chad
CS	Czechoslovakia	LU	Luxembourg	TG	Togo
DE	Germany	MC	Monaco	US	United States of America
DK	Denmark	MG	Madagascar		
ES	Spain				

Portable Glucose Sensor

The invention relates to a portable apparatus for measuring the concentration of a substance in a body fluid, e.g. for measuring the glucose level in the blood. To be designated as portable such a device should have dimensions not
5 much bigger than those of a king size pack of cigarettes, i. e. about 20 x 50 x 100 mm.

Persons suffering from diabetes must frequently check the glucose concentration in their blood to be able to adjust their insulin treatment so that a close to normal glucose concentration is maintained. The concentration should be
10 measured once a day and a profile involving several measurements within 24 hours should be taken once a fortnight. For this purpose, a device is wanted which the patient may carry in his pocket and use to make a measurement within about a minute when and where he should want to without being dependent on outer installations.

15 To meet these wishes an apparatus must have dimensions as stated, it must permit measurements on samples of unprepared blood, that is if any preparation of the sample has to be made it must be made automatically inside the apparatus, the needed size of the sample should not exceed 25 μ l corresponding to a drop of blood which may be provided by pricking a finger or an earlobe, and
20 the apparatus should be able to perform a great number of measurements, say 100, before services are needed in the form of replacing consumed articles.

Portable glucose sensors are known which are based on colouring of a strip when the glucose in a sample placed on the strip is oxidized using an enzyme. The colouring is evaluated by visual inspection or using a miniaturized
25 photometer. However, the presence of the blood cells in the sample makes the result unprecise.

Other known glucose sensors are based on the use of amperometric sensors measuring oxygen consumption or hydrogen peroxide production when glucose is oxidized in the presence of glucose oxidase. However, when the sample
30 is placed on the electrodes of the sensor other chemical decompositions take place interfering the result of the measurement. So, the use of amperometric sensors

causes problems as large drift, short lifetime, difficulties with calibration, lack of accuracy, and various interferences.

Consequently, it is the object of the invention to provide a portable glucose sensor by which these problems are overcome.

5 This is obtained by a portable glucose sensor for measuring the glucose content in a blood sample, which according to the invention is characterized in that the measuring means is of a type measuring the heat production when the glucose in the sample is decomposed in the presence of an enzyme.

According to the invention, the measuring means may be an enzyme
10 calorimeter comprising a reactor containing an enzyme carrier material on the surface of which an enzyme is immobilized, an inlet and an outlet for liquid and a pair of thermosensors measuring the temperature increase of a liquid passing through the reactor.

Such enzyme calorimeters are known from US 4,021,307, but so far
15 everything seems to be against its use in a portable device.

The known enzyme calorimeters cannot be used for measuring on whole blood as the blood cells will very quickly cause clogging of the column. This problem is reduced a little, but not entirely, as blood has to be diluted at least ten times to obtain a glucose concentration within the range where the column could be
20 expected to respond linearly to the concentration, but this, on the other hand, means that the apparatus should carry a buffer solution sufficient to prepare about 100 samples. As the device according to US 4,021,307 works with samples of 1 ml, this means that about 100 ml buffer should be contained in the device for the dilution of the blood alone where to comes the buffer necessary for rinsing the column after
25 each measurement. Consequently, the buffer reservoir alone would have a bigger volume than can be permitted for the whole device if it should be given the designation "portable". With a 10 times dilution of the blood, a sample of 100 μ l whole blood should be provided which is about four times as much as could commonly be obtained by a simple pricking of a finger or an earlobe.

30 Another thing counteracting the use of the enzyme column in a portable apparatus is that the column should be inserted into a thermostatic bath or another kind of thermostate. If the device during the measurement should be maintained at

a constant temperature, it will require a preheating period to establish this temperature before a measuring could be performed, i.e. the measurement cannot be made immediately. Further, the preheating and the temperature control will be energy consuming and will call for rather large batteries counteracting the portability.

5 Surprisingly, all these problems are solved if the prejudice of making a portable device is neglected. Large volumes of buffer are unnecessary if the column is miniaturized. At the same time the needed amount of whole blood is reduced, when the flow rate through the column is reduced in accordance with the reduction of the size of the column. Most surprisingly, the thermostatic bath can be
10 omitted when the column is made sufficiently small. This is due to the fact that temperature differences in a small device are quickly levelled, the more quickly the smaller the size, so that all parts of the device will have the same temperature.

A very small reactor may be obtained if the reactor is constituted by a number of parallel channels provided in a substrate and covered by a cover sheet
15 bonded to the substrate, the respective ends of the channels being connected to the inlet and the outlet, and the walls of the channels constitute the carrier material on the surface of which an enzyme is immobilized. The substrate may be made from any material suited for the provision of a microchannel structure by machinery or moulding.

20 The substrate may be a silicon wafer. Thereby advantage may be taken from the already advanced microfabrication technology to provide a mechanical construction with high precision, strength, and reliability, and the silicon substrate is further advantageous where miniaturized mechanical devices and components must be integrated or interfaced with electronics. Also the well-established immobilizing
25 techniques for glass, e.g. Controlled-Pore Glass, and for silicon dioxide can be conveniently applied in silicon materials due to their similarity in structure.

When a silicon wafer is used the thermosensors may appropriately be thermistors integrated on the substrate.

According to the invention, the reactor may be surrounded by a tube
30 forming a tight wound helix which tube together with the reactor forms a flow path for a buffer and for the sample. This arrangement decreases the heat leakage to the surroundings and levels heat gradients which could influence the reactor. The

outside of the enzyme column is insulated with plastic foam.

As the parameter measured is the differential temperature of the liquid before and after its passage through the reactor, the absolute temperature of the device will be of minor importance.

5 The reaction temperature is not important since excess of enzyme is used leading to conversion of virtually all of the substrate glucose. The temperature response is therefore very little effected by changes in the ambient temperature. Furthermore, this minimizes the need for calibration. The same calibration curve can be used even after considerable loss of enzyme effectivity.

10 The risk of clogging due to the blood cells in the sample is reduced by using as the enzyme carrier a macro porous material having a pore size bigger than 10 μm . According to the invention, the use of a super porous enzyme carrier has shown to be advantageous, that is a material with pores which penetrates the material completely. A suitable carrier material is agarose.

15 In the following, the invention will be described in further details with reference to the drawings wherein

Fig. 1 illustrates schematically the function of an enzyme column for measuring the concentration of a substance in a sample,

Fig. 2 shows schematically a portable apparatus according to the invention,

20 Fig. 3 shows schematically an arrangement of the temperature sensors,

Fig. 4 shows another arrangement of the temperature sensors,

Fig. 5 shows schematically a blood dilution and filtration arrangement, and

Fig. 6 illustrates schematically a reactor constituted by channels in a substrate.

25 Figure 1 illustrates schematically the function of an apparatus for measuring the concentration of a substance in a sample which measuring is based on measuring the heat generated by enzymatic oxidation of the substance. A pump 1 forces a buffer through the apparatus at a preset flow rate. At a certain moment the buffer flow is replaced by a sample package which is injected through an
30 injection valve 2. The heat produced by the passage of the sample package through an enzyme column 3 is measured by temperature transducers placed in the inlet and in the outlet of the column, and the signal obtained is sent to an amplifier 4 and is

recorded by a recorder 5 at which the temperature difference appears as a peak having a height which is representative of the concentration of the substance in the sample.

Figure 2 shows schematically a portable apparatus for measuring the concentration of a substance in whole blood. The apparatus is mainly intended for measuring the glucose concentration in whole blood, but may be used to measure other substances in a body fluid, e.g. alcohol or urea.

The buffer pump is provided as a cylinder ampoule 10 having a piston 11 with a piston rod 12 actuated by a pump motor 13 controlled by a microprocessor 14. The pump is controlled to force a buffer 15 through a lead 16, an injection valve 17, a tight wound helix shaped tube 18 surrounding an enzyme column 19, through this enzyme column 19, and through a return lead 20 back to the space above the piston 11, the cylinder ampoule 10 being closed at its rear end by a closure through which the piston rod 12 may pass sealingly. The turnings of the helix shaped tube 18 are closely adjacent to each other, although in the drawing they are spaced.

A sample of whole blood is sucked in through a needle 21 and through the valve 17 which may perform several valve functions. The sample is sucked into another pump 22 which controlled by the microprocessor 14 has been prefilled with a measured amount of the buffer and now still controlled by the microprocessor dilutes a measured amount, e.g. 1 μ l, of the whole blood in the measured amount of buffer, so that the chamber 23 is now filled with a sample of known volume and dilution.

At a moment when the buffer flow has been on for a time sufficient to stabilize the heat difference of the inlet and the outlet of the column caused by the flow resistance in this column, the valve 17 is shifted to inject the sample which for some time replaces the buffer flow, but with the same flow rate. When the chamber 23 is emptied, the valve 17 shifts back to the buffer flow which forces the sample through the column as a package or plug. These shifts and the flow rate of the injected sample are all controlled by the microprocessor 14.

During its passage through the column, the glucose in the sample is decomposed in the presence of the enzyme in the column. This decomposition

causes a heating of the sample which heating is measured by the peak difference of the temperatures at the inlet and at the outlet of the column which temperatures are measured by thermistors 24 and 25, respectively, placed in the flow. On the basis of the flow rate, the dilution, and the heating of the fluid due to the decomposition of the sample when passing the column, the microprocessor can calculate with high accuracy the glucose concentration in the whole blood sample and show the result on a display 26.

The needle 21 may be designed for pricking through the skin of a patient to directly suck in a sample of body fluid. After use the needle may be retracted into a chamber 27 for disinfection and in all events the needle, also if it is not used for pricking, must be rinsed to avoid that coagulating residual blood clogs the bore of the needle. Spent buffer may be used for the rinsing to economize with the liquid in the apparatus. Parts coming into contact with undiluted blood may further be heparinized to avoid coagulation.

The enzyme column 19 is surrounded by the helix 18 formed by a thin steel tubing. Thereby, a shield is provided protecting the column against outside temperature gradients. Further, the column and the helix are surrounded by an insulating cover 28 made from plastic foam.

In Figure 2, the liquid will pass through the helix before entering the column. However, the helix may as well be placed downstream of the column.

In Figure 2, the thermistors 24 and 25 are shown as placed immediately upstream and downstream, respectively, of the enzyme column. They may, however, both be placed downstream of the column separated by a delay coil 32 sufficiently large to accommodate the sample package as sketched in Fig. 3. When the thermistor 30 is heated by the sample which has just passed the column 33 the thermistor 31 still measures the temperature of the unheated buffer.

In this reference temperature is included the heating of the buffer due to the friction in the column and temperature fluctuation caused by irregularities in the flow rate through the column will be compensated for.

In Figure 4 is shown another arrangement for differential temperature determination. According to this arrangement, the flow, including that containing the sample, is equally split between two columns, a reference column 42 and an enzyme

column 43. A thermistor 40 measures the temperature downstream of the enzyme column 43 and another thermistor 41 measures the reference temperature downstream of the reference column 42. By this arrangement, any nonspecific heat effects occurring in the columns will be compensated for.

5 The column is filled with a macro porous material on which enzyme in excess is immobilized. Thereby a good operational stability and low susceptibility to interferences and inhibitors to the enzyme are obtained. The carrier material is chosen to allow diluted whole blood to be used as sample without clogging the column. A special suited material is a super porous agarose gel having pores all way
10 through the particles which pores are big enough for blood cells to pass.

 An alternative way of increasing the useful life of the column is to remove the blood cells from the sample using a single hollow dialyze fibre as shown in figure 5. The whole blood is led through a fibre 50 having an inlet 51 and an outlet 52. The fibre 50 is surrounded by a space 53 to which the diluting buffer is led
15 through an inlet 54 and removed through an outlet 55. The small molecules of the substance to be measured may pass through the wall of the fibre into the surrounding liquid, but large molecules and cells will be retained. A protection of the column is obtained at the expense of a more complicated diluting procedure.

 Figure 6 schematically shows a reactor constituted by a number of fine
20 channels 60 provided in a substrate 61. Manifolds 62,63 are provided at the respective ends of the channels 60. These manifolds are also provided in the substrate and are connected to an inlet tube 64 and an outlet tube 65, respectively. The channels 60 are covered by a cover sheet 66 bonded to the substrate 61 by a connective film 67. By a heat conductive glue thermosensors 68 and 69 are bonded
25 to the inlet 64 and outlet 65, respectively.

 The dimensions of the substrate are typically 14 x 6 x 0.4 mm with a 5 x 1 x 0.014 mm reactor consisting of 33 parallel channels with a total volume of 0.02 μ l.

 The invention is based on the discovery that the performances, such
30 as signal to noise ratio and sensitivity are virtually unchanged when a conventional enzyme calorimetric device is miniaturized. Differential measurement technique makes it even possible to omit the temperature control when the distances between

the measuring and reference temperature sensors and the overall size of the column become sufficiently small. Hereby the construction could be brought to a size making it usable in a really portable device.

Another important discovery is that certain macroporous enzyme support materials permit whole blood to be passed through repeatedly even a miniaturized enzyme reactor without clogging.

The invention is described with thermistors as the thermosensors, but any other kind of sensors may of course be used just as the pumps and valves used may be of any known kind without deviating from the scope of the invention.

10 In the same way the apparatus may be used with different enzymes for measuring different metabolites such as urea, lactate, ethanol, triglycerides etc. For the determination of glucose, hexokinase as well as glucose dehydrogenase can be used besides glucose oxidase.

CLAIMS

1. A portable apparatus for measuring the concentration of a substance in a body fluid, e.g. the glucose content in a blood sample, characterized in that the measuring means is of a type measuring the heat production when the substance
5 in the sample is decomposed in the presence of an enzyme.

2. A portable apparatus according to claim 1, characterized in that the measuring means is a micro enzyme calorimeter comprising a reactor chamber containing an enzyme carrier material on the surface of which an enzyme is immobilized, an inlet and an outlet for liquid and a pair of thermosensors measuring
10 the temperature increase of a liquid passing through the reactor.

3. A portable apparatus according to claim 2, characterized in, that the reactor is constituted by a number of parallel channels provided in a substrate and covered by a cover sheet bonded to the substrate, the respective ends of the channels being connected to the inlet and the outlet, and that the walls of the
15 channels constitute the carrier material on the surface of which an enzyme is immobilized.

4. A portable apparatus according to claim 3, characterized in, that the substrate is a silicon wafer.

5. A portable apparatus according to claim 4, characterized in, that the
20 thermosensors are thermistors integrated on the substrate.

6. A portable apparatus according to claim 2, 3, 4, or 5, characterized in that a tube forming a tight wound helix surrounds the reactor and together with the reactor forms a flow path for a buffer and for the sample.

25 7. A portable glucose sensor according to claim 2, characterized in that the enzyme carrier is a macro porous material having a pore size bigger than 10 μm .

8. A portable glucose sensor according to claim 7, characterized in that the enzyme carrier is super porous having pores which penetrate the material completely.

9. A portable glucose sensor according to claim 7 or 8, characterized
5 in that the enzyme carrier material is agarose.

10. A portable apparatus according to any of the preceding claims, characterized in that it further comprises receiving means for the whole blood, means for providing a diluted sample of a predetermined volume and a predetermined dilution, means for passing a buffer through the enzyme column at a
10 predetermined flow rate, means for incidentally replacing the buffer flow with a flow of diluted sample, means for collecting used buffer and sample, means for timing and controlling the flow of the buffer and the sample, and means for calculating and displaying.

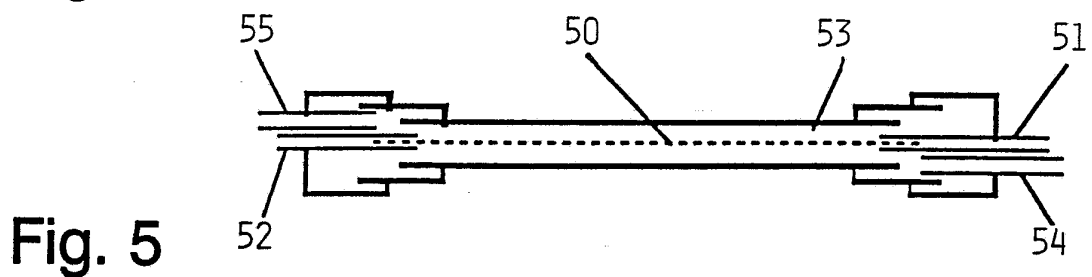
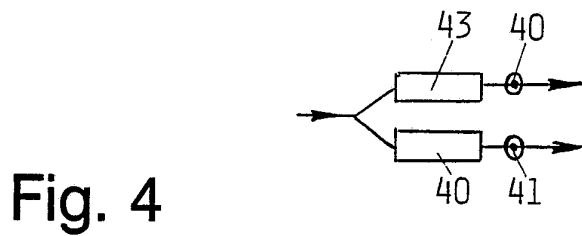
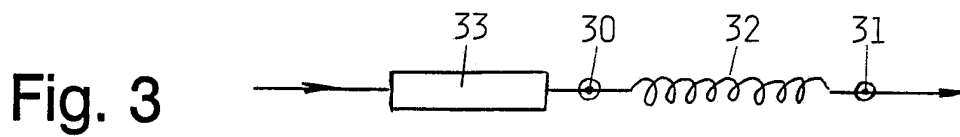
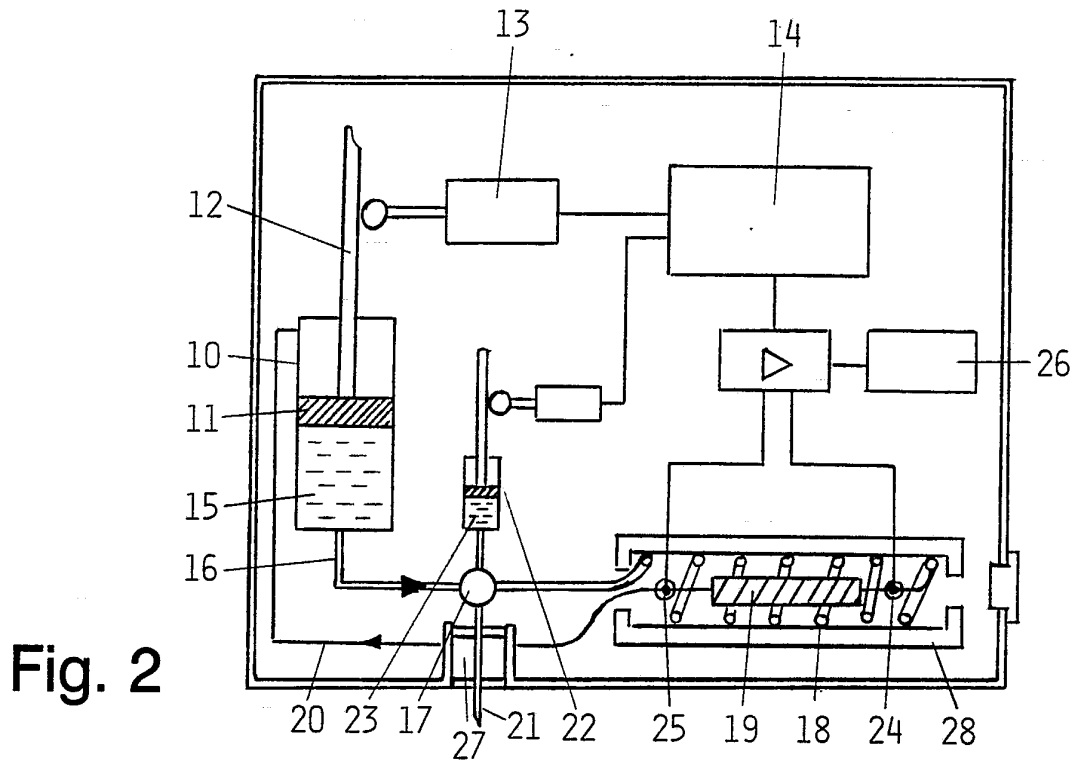
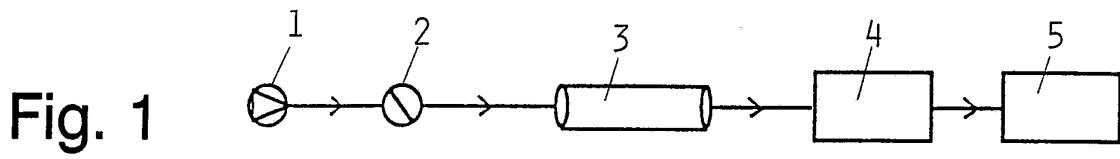

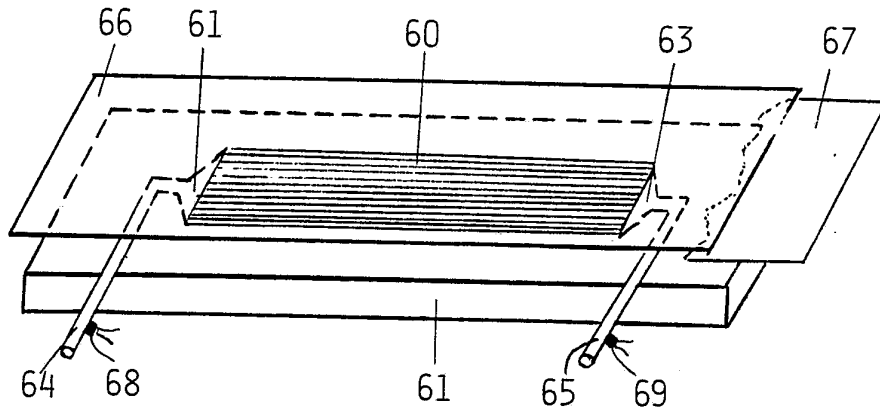



Fig. 6

INTERNATIONAL SEARCH REPORT

International Application No PCT/DK 92/00213

I. CLASSIFICATION OF SUBJECT MATTER (If several classification symbols apply, indicate all) ⁶		
According to International Patent Classification (IPC) or to both National Classification and IPC		
IPC5: G 01 N 25/48, C 12 M 1/40		
II. FIELDS SEARCHED		
Minimum Documentation Searched ⁷		
Classification System	Classification Symbols	
IPC5	G 01 N; C 12 M; C 12 Q	
Documentation Searched other than Minimum Documentation to the Extent that such Documents are included in Fields Searched ⁸		
SE,DK,FI,NO classes as above		
III. DOCUMENTS CONSIDERED TO BE RELEVANT⁹		
Category *	Citation of Document, ¹¹ with indication, where appropriate, of the relevant passages ¹²	Relevant to Claim No. ¹³
X	DE, A1, 3839798 (EPPENDORF-NETHELER-HINZ GMBH) 7 June 1990, see column 1, line 55 - column 2, line 19; column 4, line 30 - line 66; column 5, line 14 - line 35; column 6, line 30 - line 58; figures 3,4	1,2
Y	--	3-5
A		6-10
X	US, A, 4935345 (ERIC J. GUILBEAU ET AL) 19 June 1990, see column 6, line 26 - line 38; column 13, line 54 - column 14, line 38; abstract	1
Y	--	3-5
A		6-10
<p>* Special categories of cited documents: ¹⁰</p> <p>"A" document defining the general state of the art which is not considered to be of particular relevance</p> <p>"E" earlier document but published on or after the International filing date</p> <p>"L" document which may throw doubts on priority claim(s) or which is cited to establish the publication date of another citation or other special reason (as specified)</p> <p>"O" document referring to an oral disclosure, use, exhibition or other means</p> <p>"P" document published prior to the international filing date but later than the priority date claimed</p> <p>"T" later document published after the international filing date or priority date and not in conflict with the application but cited to understand the principle or theory underlying the invention</p> <p>"X" document of particular relevance, the claimed invention cannot be considered novel or cannot be considered to involve an inventive step</p> <p>"Y" document of particular relevance, the claimed invention cannot be considered to involve an inventive step when the document is combined with one or more other such documents, such combination being obvious to a person skilled in the art.</p> <p>"&" document member of the same patent family</p>		
IV. CERTIFICATION		
Date of the Actual Completion of the International Search	Date of Mailing of this International Search Report	
14th October 1992	21 -10- 1992	
International Searching Authority	Signature of Authorized Officer	
SWEDISH PATENT OFFICE	 Gunnel Wästerlid	

III. DOCUMENTS CONSIDERED TO BE RELEVANT (CONTINUED FROM THE SECOND SHEET)		
Category *	Citation of Document, with indication, where appropriate, of the relevant passages	Relevant to Claim No
A	US, A, 5017494 (ISAO KARUBE ET AL) 21 May 1991, see claim 1 --- -----	1-10

ANNEX TO THE INTERNATIONAL SEARCH REPORT
ON INTERNATIONAL PATENT APPLICATION NO.PCT/DK 92/00213

This annex lists the patent family members relating to the patent documents cited in the above-mentioned international search report.
The members are as contained in the Swedish Patent Office EDP file on 30/09/92
The Swedish Patent Office is in no way liable for these particulars which are merely given for the purpose of information.

Patent document cited in search report	Publication date	Patent family member(s)	Publication date
DE-A1- 3839798	90-06-07	NONE	
US-A- 4935345	90-06-19	NONE	
US-A- 5017494	91-05-21	NONE	