

(No Model.)

C. MUNSON.
SEWER WELL AND GRATE.

No. 490,301.

Patented Jan. 24, 1893.

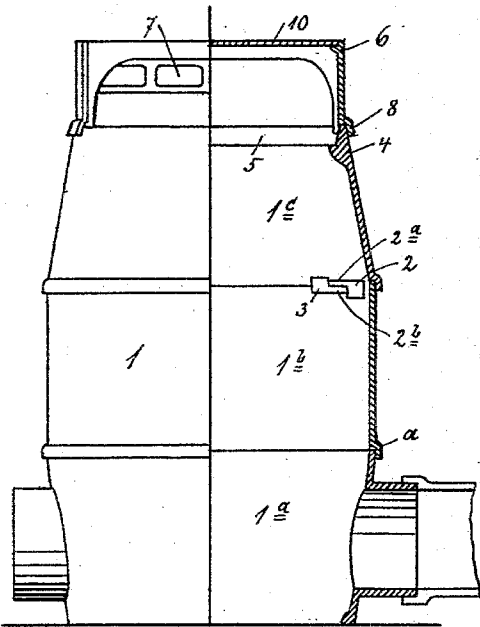

Fig. 1

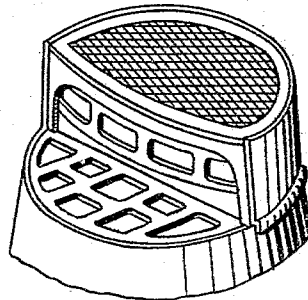

Fig. 2^a.

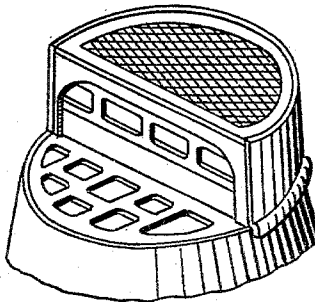

Fig. 3^a

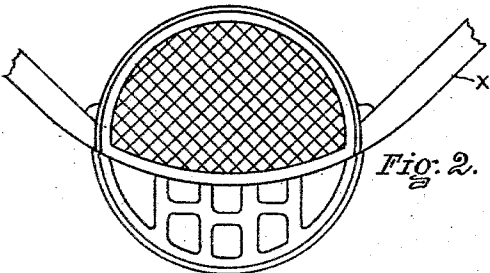

Fig. 2.

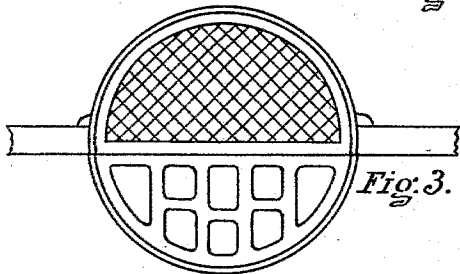

Fig. 3.

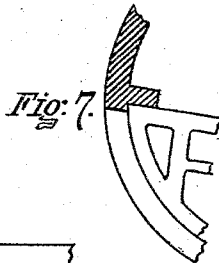

Fig. 7.

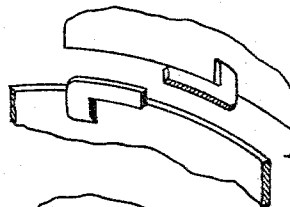

Fig. 4.

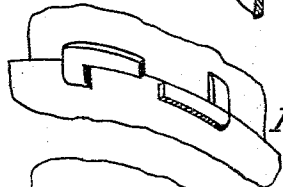

Fig. 5.

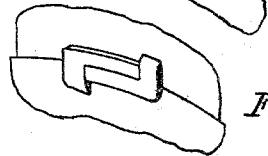

Fig. 6.

WITNESSES.
Rich. A. George.
George A. Hayward

INVENTOR.
Council Munson
By Risley & Robinson
Attys

UNITED STATES PATENT OFFICE.

COUNCIL MUNSON, OF UTICA, NEW YORK.

SEWER WELL AND GRATE.

SPECIFICATION forming part of Letters Patent No. 490,801, dated January 24, 1893.

Application filed May 13, 1892. Serial No. 432,937. (No model.)

To all whom it may concern:

Be it known that I, COUNCIL MUNSON, of Utica, in the county of Oneida and State of New York, have invented certain new and useful Improvements in Sewer Wells and Grates; and I do hereby declare that the following is a full, clear, and exact description of the invention, which will enable others skilled in the art to which it appertains to make and use the same, reference being had to the accompanying drawings, and to the letters and numerals of reference marked thereon, which form part of this specification.

My invention relates to an improvement in sewer wells and grates.

It is among the objects of my invention to provide a sewer well in detachable sections which facilitates the manufacturing and handling of the sections and provided with locks for securely uniting the sections.

It further consists of and provides for a sewer well and grate which is particularly intended to be placed in the curb of a street and allow the sewage to pass through suitable openings in the vertical side and horizontal top of a portion of the well. The parts are also adjustable to fit the upper or grate portion of the sewer to make it register with the curb line of the street.

In the drawings which accompany and form a part of this specification, and in which similar letters and numerals of reference refer to corresponding parts in the several figures, Figure 1 shows partially in elevation and partially in vertical sections, my improved sewer well and grate. Fig. 2, shows a plan view of the sewer well and grate adapted in form to be placed in a curved curb. Fig. 2^a shows in perspective the well shown in Fig. 2. Fig. 3, shows a plan view of the grate and well placed in a straight curb. Fig. 3^a, shows in perspective the grate and portion of well shown in Fig. 3. Fig. 4, shows locking projections provided on sections of the well for securely locking the sections together. Fig. 5, shows the same part shown in Fig. 4, placed together preparatory to locking. Fig. 6, shows the locks completely locked together. Fig. 7, shows a plan view of a portion of the horizontal portion of the grate in connection with a section of the well taken on line A—B, of Fig. 1.

The well, 1, consists of a bottom section 1^a,

a middle section 1^b and top section 1^c. If the height will permit two or more middle sections, as 1^b may be used. The sections are circular in form and cast with a flange as *a* adapted to embrace the next section. On the sections are also provided locking pieces 2 and 3, which consist of a projecting rib 2^a on the inside of the casing and a stop adapted to engage the end of the projection and cause the projections 2^a to register with each other when in locking position. The lock piece 3 is similar in shape to 2^a. The upper section of well is provided with an inwardly projecting rim as 4, on which is adapted to rest the horizontal portion 5 of grate. Above grate 5, is provided a curb section 6, which is of a size and shape adapted to cover that portion of the well inside of the curb line of the street. In the curb face of section 6, is provided an opening with a suitable grate as 7. The curb section 6, is provided with an overhanging flange 8, adapted to surround the upper section 1^c of the well so far as the curb section 6 extends. On the inside of the curb section 6, is provided a downwardly extending lug 9, which engages the rear side of grate 5, and holds the same in correct position in the upper end of the well. It will be observed that the grate 5 and the curb section 6, are so arranged that they may be turned to any desired position on the upper end of the well to correspond with the curb line of the street. In Figs. 1 and 2, the curb line is indicated by *x*. In the upper end of the curb section and resting on a suitable inwardly extending flange is a removable plate or cover 10, through which access may be had to the interior of the sewer well.

In setting up the well the bottom section 1^a is placed in shape and connected with the sewer, and by reason of the well being in sections, easy access is had for the purpose of attaching or connecting it with the sewer. The sections 1^b and 1^c are then successively placed upon the bottom section and by rotating the sections, the locking projections 2 and 3, will be brought into engagements which firmly secures the sections together and prevents displacement. Grate 5 and curb section 6, are then placed in position and rotating brings the curb line of the curb section so as to register with the curb line of the street.

It will be understood that the grate 5, is to

be placed on line with or slightly below the gutter of the street, the grate 5, forming essentially a portion of the gutter. It will also be observed that the inner side of grate 5, 5 terminates substantially at the curb line leaving the remaining portion of the sewer well open and free, which construction it is claimed will receive the sewage without becoming clogged with obstruction in better shape than 10 where the grate extends from the gutter line upon the vertical side of the curb.

What I claim as new and desire to secure by Letters Patent is:

1. The combination of a circular sewer well, 15 and a curb section having a vertical grated curb face, spanning the circle of the well and the curb section being of a form whereby a portion of the top of the well is exposed and a part is covered by the section, the curb section being rotatable on and independent of 20 the well, to enable the curb face of the curb section to conform to the curb line of the street without reference to the well, substantially as set forth.

2. The combination of a circular sewer well 25 having a grate supporting rib, a gutter grate partially covering the top of the well and resting on the rib, and a curb section having a vertical grated curb face spanning the circle 30 of the well and the curb section being of a form as shown, whereby a portion of the top of the well is exposed and a part is covered by the section and having projections projecting adjacent to the grate supporting rib and adapted to engage and retain the gutter 35 grate in position, the curb section being rotatable on and independent of the well, whereby the curb face of the curb section and the gutter grate may be made to conform to the curb line of the street, substantially as set 40 forth.

In witness whereof I have affixed my signature in presence of two witnesses.

COUNCIL MUNSON.

Witnesses

GEORGE C. CARTER,
JOSIAH PERRY.