



US00D362014S

United States Patent [19]

[11] Patent Number: **Des. 362,014**

Ishibashi et al.

[45] Date of Patent: **** Sep. 5, 1995**

- [54] **DEVELOPING DEVICE FOR COPYING MACHINE**
- [75] Inventors: **Masaaki Ishibashi, Kunitachi; Kazushi Watanabe, Yokohama, both of Japan**
- [73] Assignee: **Canon Kabushiki Kaisha, Tokyo, Japan**
- [**] Term: **14 Years**
- [21] Appl. No.: **10,829**
- [22] Filed: **Jul. 21, 1993**
- [30] **Foreign Application Priority Data**

Jan. 22, 1993 [JP] Japan 5-1456

[52] U.S. Cl. **D18/43; D18/40**

[58] Field of Search D18/36, 40, 43; 222/DIG. 1; 355/206, 208, 245, 260, 298

[56] References Cited

U.S. PATENT DOCUMENTS

D. 276,916	12/1984	Masaki	D18/40
D. 287,023	12/1986	Masaki	D18/40
D. 298,255	10/1988	Hirata	D18/40
D. 298,259	10/1988	Masaki	D18/40
D. 298,333	11/1988	Masaki et al.	D18/40
D. 298,334	11/1988	Masaki et al.	D18/40
D. 298,335	11/1988	Masaki et al.	D18/40

D. 298,336	11/1988	Masaki	D18/40
D. 303,541	9/1989	Aoyama	D18/40
D. 303,542	9/1989	Tashiro	D18/36
D. 303,543	9/1989	Seki	D18/36
D. 308,885	6/1990	Okayama et al.	D18/36
D. 310,539	9/1990	Komada et al.	D18/40
D. 313,615	1/1991	Tokuda	D18/36
D. 313,616	1/1991	Tokuda	D18/36
D. 313,813	1/1991	Tokuda	D18/36
D. 314,212	1/1991	Komada et al.	D18/40
4,816,877	3/1989	Keen	D18/43 X

Primary Examiner—Alan P. Douglas
Assistant Examiner—Caron D. Veynar
Attorney, Agent, or Firm—Fitzpatrick, Cella, Harper & Scinto

[57] CLAIM

The ornamental design for a developing device for copying machine, as shown and described.

DESCRIPTION

FIG. 1 is a front elevational view of a developing device for copying machine showing our new design; FIG. 2 is a rear elevational view thereof; FIG. 3 is a top plan view thereof; FIG. 4 is a bottom plan view thereof; FIG. 5 is a left side elevational view thereof; FIG. 6 is a right side elevational view thereof; and, FIG. 7 is a perspective view thereof.

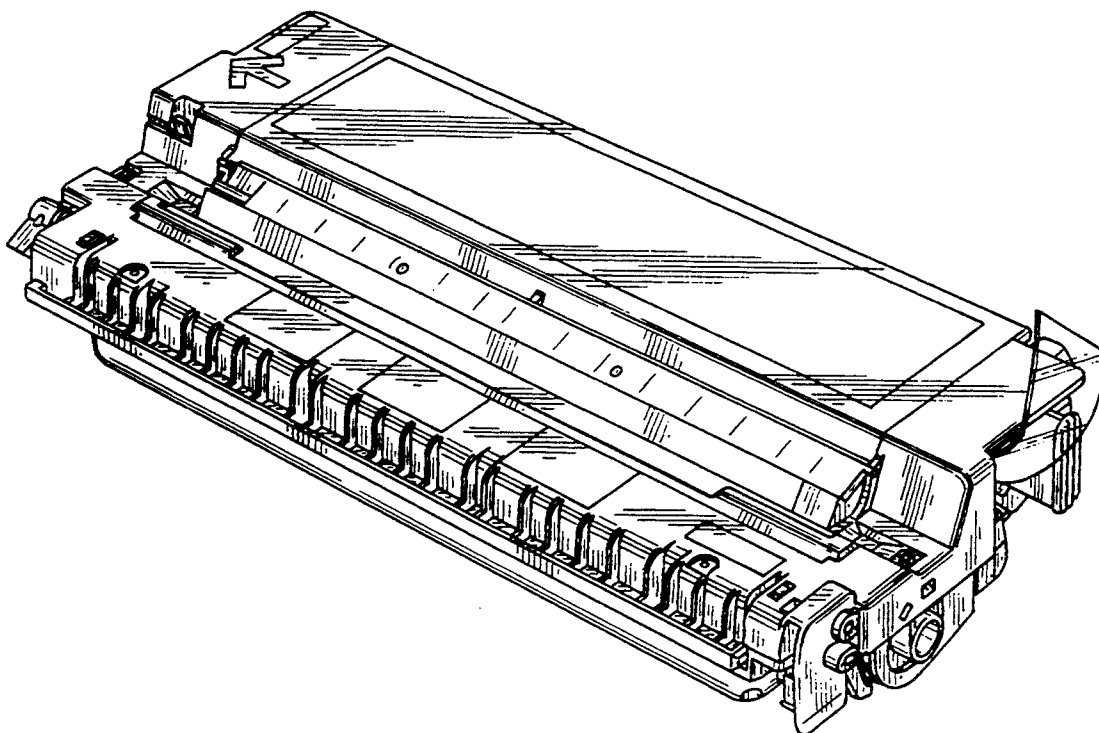

FIG. 1

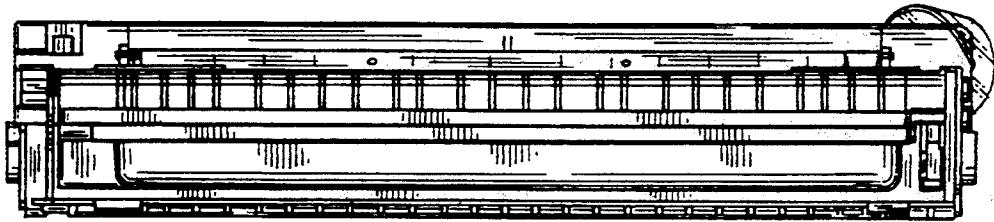

FIG. 2

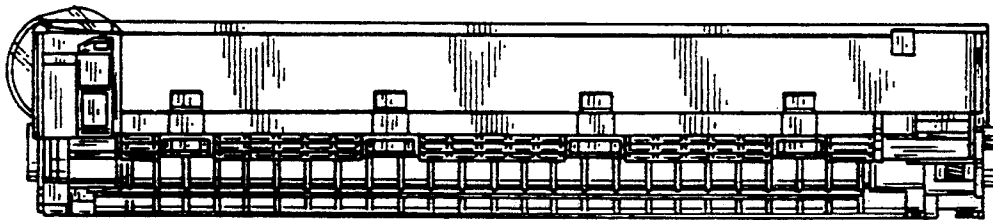

FIG. 3

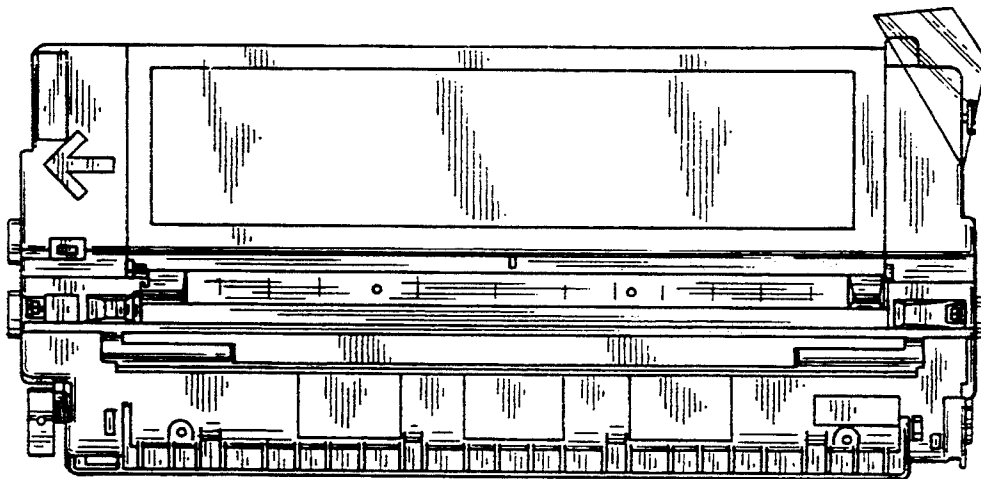

FIG. 4

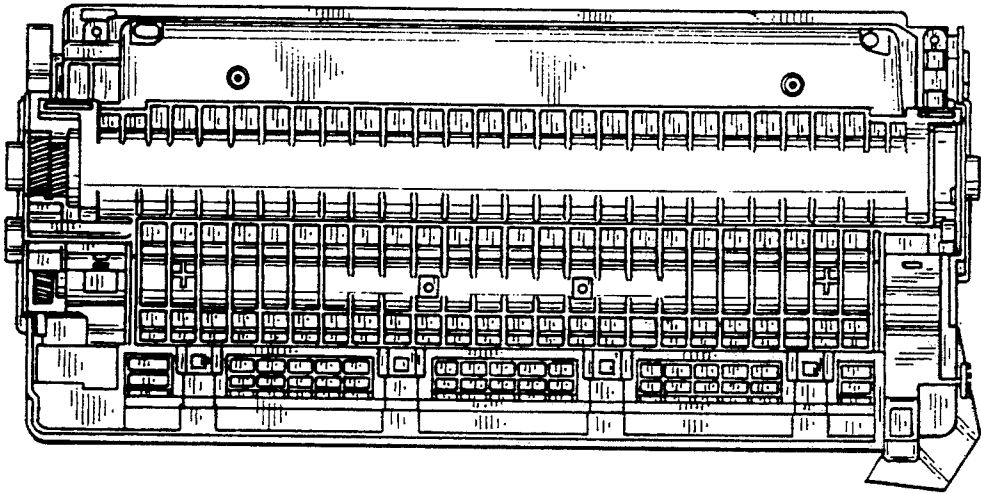

FIG. 5

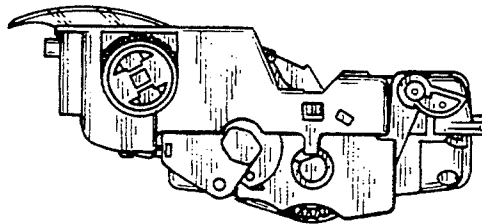

FIG. 6

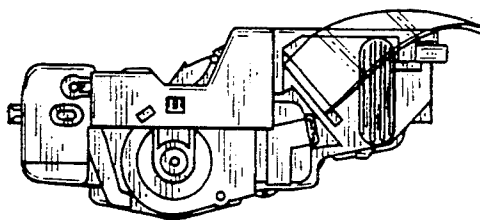

FIG. 7

