



US00D800226S

(12) **United States Design Patent**
Zeng

(10) **Patent No.:** **US D800,226 S**

(45) **Date of Patent:** **** Oct. 17, 2017**

- (54) **AUTOMOBILE FACE**
- (71) Applicant: **Chengdu Furinkazan Automobile Service Co., Ltd., Chengdu (CN)**
- (72) Inventor: **Cheng Zeng, Chengdu (CN)**
- (73) Assignee: **CHENGDU FURINKAZAN AUTOMOBILE SERVICE Co. LTD, Chengdu (CN)**
- (**) Term: **15 Years**
- (21) Appl. No.: **29/550,560**
- (22) Filed: **Jan. 5, 2016**
- (30) **Foreign Application Priority Data**

D464,087	S	*	10/2002	Wu	D21/433
D519,066	S	*	4/2006	Ney	D12/163
D521,424	S	*	5/2006	Sackley	D12/163
D523,912	S	*	6/2006	Tucker	D21/433
D534,106	S	*	12/2006	Matei	D12/169
D535,594	S	*	1/2007	Schiavone	D12/169
7,185,930	B2	*	3/2007	Helzner	G02B 7/182
						180/68.6
D560,144	S	*	1/2008	Tant	D12/169
D565,467	S	*	4/2008	Aneiros	D12/91
D568,211	S	*	5/2008	Vardis	D12/91
D570,751	S	*	6/2008	Choi	D12/169
D637,530	S	*	5/2011	Aris	D12/163
D711,295	S	*	8/2014	Mackay	D12/169
D733,619	S	*	7/2015	Glover	D12/163
D737,740	S	*	9/2015	Goepfel	D12/169
D738,799	S	*	9/2015	Goepfel	D12/169
D746,731	S	*	1/2016	Quezada	D12/163
D759,550	S	*	6/2016	Vena	D12/163
2014/0167454	A1	*	6/2014	Clapie	B62D 25/085
						296/203.02

- Jul. 7, 2015 (CN) 2015 3 0239815
- (51) **LOC (10) CL.** **21-01**
- (52) **U.S. CL.**
USPC **D21/433; D12/163**
- (58) **Field of Classification Search**
USPC D12/91, 163-171; D21/313, 433-434;
180/68.1, 68.6
CPC B60K 11/08; B62L 39/16; B60R 19/50;
B62D 25/08
See application file for complete search history.

* cited by examiner

Primary Examiner — Manpreet Matharu
Assistant Examiner — Keith Wilson
(74) *Attorney, Agent, or Firm* — Yanling Jiang

(56) **References Cited**
U.S. PATENT DOCUMENTS

D193,656	S	*	9/1962	Boridant	D12/163
D255,231	S	*	6/1980	Margiaria	D12/170
D328,317	S	*	7/1992	Harrod	D21/433
D400,146	S	*	10/1998	Marsceau	D12/169
D410,502	S	*	6/1999	Harrod	D21/433
D417,245	S	*	11/1999	Wang	D21/433
D422,320	S	*	4/2000	Huntsberger	D21/433
D464,086	S	*	10/2002	Wu	D21/433

(57) **CLAIM**

The ornamental design for an automobile face, as shown and described.

DESCRIPTION

FIG. 1 is a Front elevational view of an automobile face showing my new design;
FIG. 2 is a Rear elevational view thereof;
FIG. 3 is a Right side view thereof;
FIG. 4 is a Left side view thereof;
FIG. 5 is a Top plan view thereof;
FIG. 6 is a Bottom plan view thereof; and,
FIG. 7 is a Perspective view thereof.

1 Claim, 7 Drawing Sheets

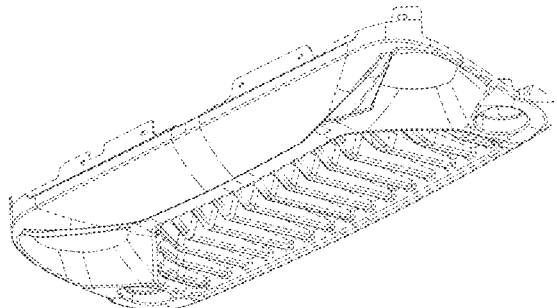
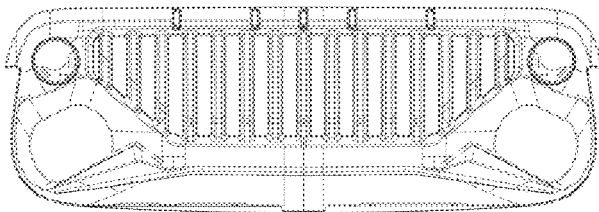

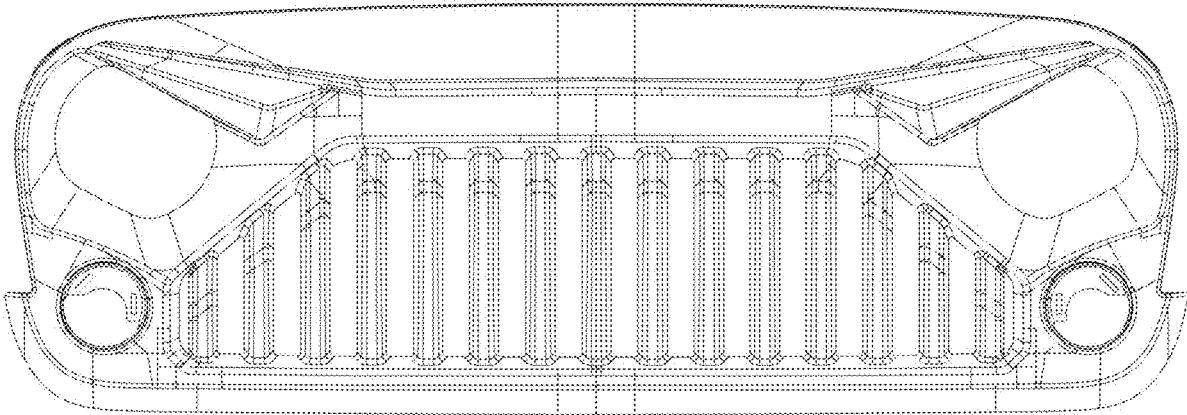

FIG. 1

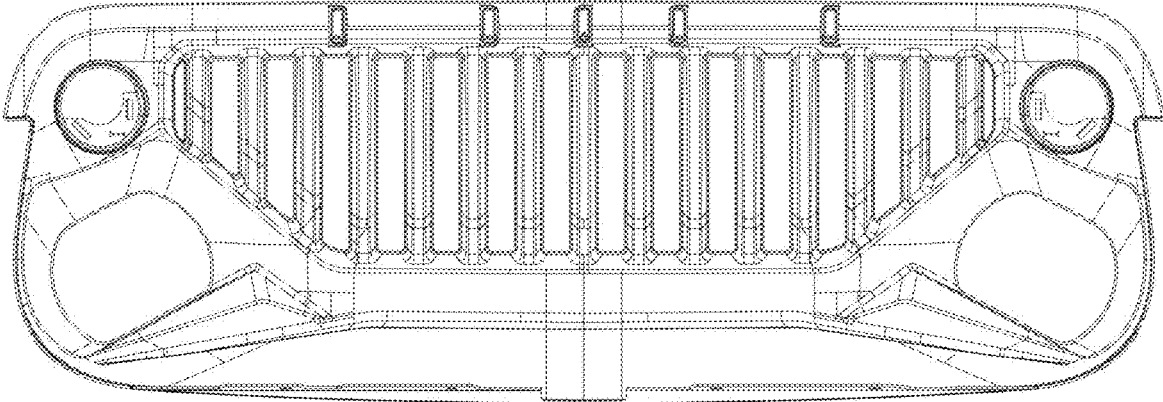

FIG. 2

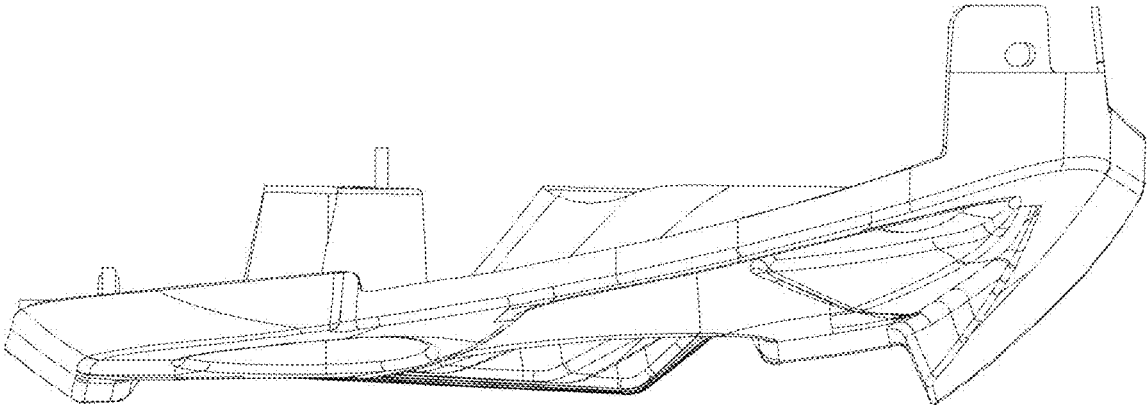

FIG. 3

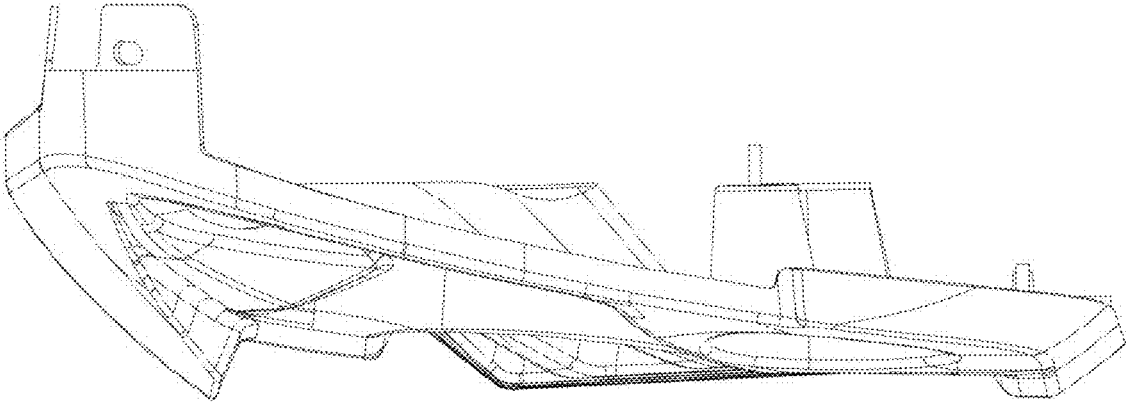

FIG. 4

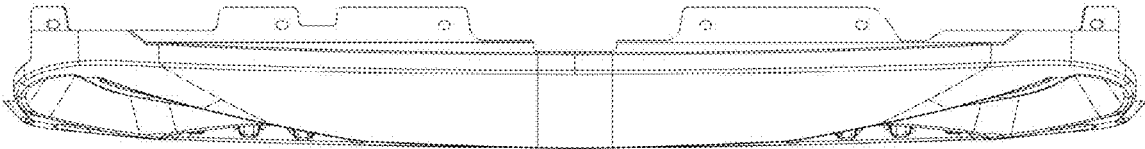

FIG. 5

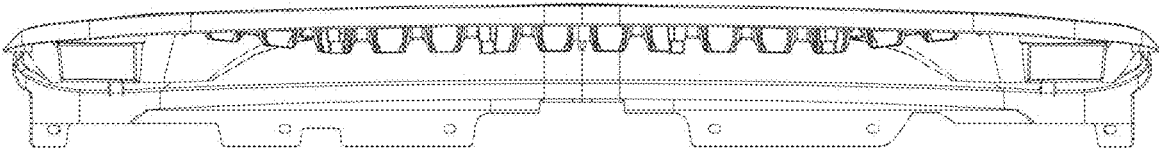

FIG. 6

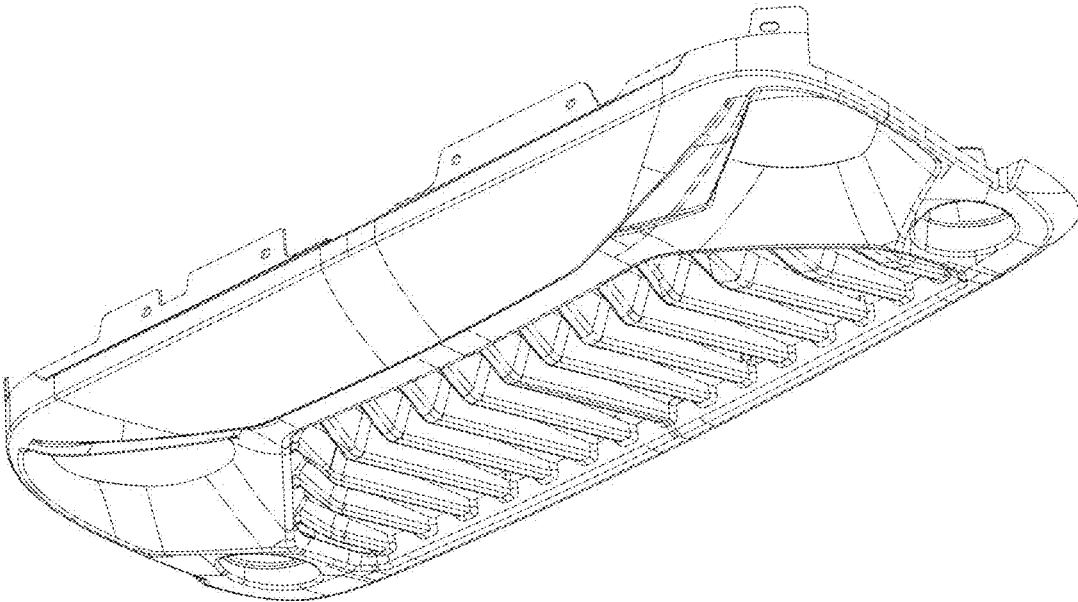

FIG. 7