



US00D761098S

(12) **United States Design Patent**
Votel et al.

(10) **Patent No.:** **US D761,098 S**

(45) **Date of Patent:** **** Jul. 12, 2016**

- (54) **SUCTION CUP GRABBER**
- (71) Applicant: **Tenacious Holdings, Inc.**, St. Paul, MN (US)
- (72) Inventors: **Thomas Votel**, Sunfish Lake, MN (US);
Nate Bohmbach, Lakeville, MN (US);
Jeffery Popowski, Roseville, MN (US)
- (73) Assignee: **Tenacious Holdings, Inc.**, St. Paul, MN (US)
- (**) Term: **14 Years**
- (21) Appl. No.: **29/522,597**
- (22) Filed: **Apr. 1, 2015**
- (51) **LOC (10) Cl.** **08-08**
- (52) **U.S. Cl.**
USPC **D8/394**
- (58) **Field of Classification Search**
USPC D8/394, 395, 396, 382, 72, 354, 356,
D8/355, 73, 371; 248/68.1, 74.3, 62;
285/420; 24/336, 341, 297; 439/758
CPC F16L 23/08; F16L 3/085; F16L 3/221;
F16L 3/137; F16L 3/08; E21F 17/02; Y10S
248/913; A44B 21/00
See application file for complete search history.

D308,263	S *	5/1990	Cook	D26/140
4,957,117	A	9/1990	Wysham		
5,164,545	A	11/1992	Kreinberg et al.		
D331,462	S	12/1992	Kraus et al.		
5,325,868	A	7/1994	Kimmelstiel		
5,423,331	A	6/1995	Wysham		
D368,169	S *	3/1996	Coker	D6/315
5,687,458	A *	11/1997	Coker	A45F 5/02 24/336
6,030,349	A	2/2000	Wilson et al.		
6,631,538	B1	10/2003	Carr		
6,872,192	B2	3/2005	Nash et al.		
D522,851	S	6/2006	Votel		
7,073,231	B2 *	7/2006	Draggool	B60R 13/0206 24/297
7,144,378	B2	12/2006	Arnott		
D537,328	S	2/2007	Votel		
7,213,307	B2 *	5/2007	Votel	A45F 5/004 24/336
7,322,851	B2	1/2008	Brookmire		
7,503,119	B2	3/2009	Schmode		
D622,584	S *	8/2010	Byron	D8/395
D625,996	S *	10/2010	Witty	D8/396

(Continued)

Primary Examiner — Ralf Seifert
(74) *Attorney, Agent, or Firm* — Skaar Ulbrich Macari, P.A.

(57) **CLAIM**
We claim the ornamental design for a suction cup grabber, as shown and described.

DESCRIPTION

FIG. 1 is a perspective view of our suction cup grabber invention.
FIG. 2 is a front elevation view of thereof.
FIG. 3 is a rear elevation view thereof.
FIG. 4 is a side elevation view thereof.
FIG. 5 is a side elevation view thereof.
FIG. 6 is a top plan view thereof; and,
FIG. 7 is a bottom plan view thereof.
The broken lines in the drawings illustrate features of the article to which the design is applied that form no part of the claim.

1 Claim, 7 Drawing Sheets

(56) **References Cited**
U.S. PATENT DOCUMENTS

1,133,388	A	3/1915	Merrill	
2,025,848	A	12/1935	Collis	
2,922,209	A	1/1960	Longhi	
3,043,902	A	7/1962	Klein	
3,388,227	A	6/1968	Basso et al.	
3,616,497	A	11/1971	Esposito, Jr.	
D249,927	S *	10/1978	Takahashi 47/6
4,429,852	A	2/1984	Tersteegen et al.	
4,598,708	A	7/1986	Beranek	
4,618,208	A	10/1986	Igarashi	
4,765,335	A	8/1988	Schmidt et al.	
4,829,999	A	5/1989	Auth	

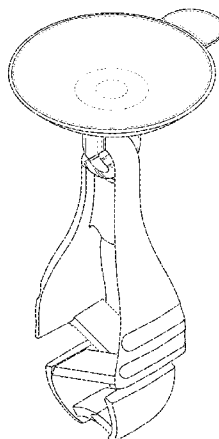

(56)

References Cited

U.S. PATENT DOCUMENTS

D640,923	S	*	7/2011	Kim	D8/394	2006/0260132	A1	11/2006	Schmode
8,341,808	B2	*	1/2013	Vermillion	A45F 5/02 24/336	2007/0004991	A1	1/2007	Shelton
2003/0229297	A1		12/2003	Christensen et al.			2007/0178759	A1	8/2007	Brookmire
							2007/0219467	A1	9/2007	Clark et al.
							2007/0270755	A1	11/2007	Von Oepen et al.
							2009/0076417	A1	3/2009	Jones
							2010/0191152	A1	7/2010	Boutillette et al.

* cited by examiner

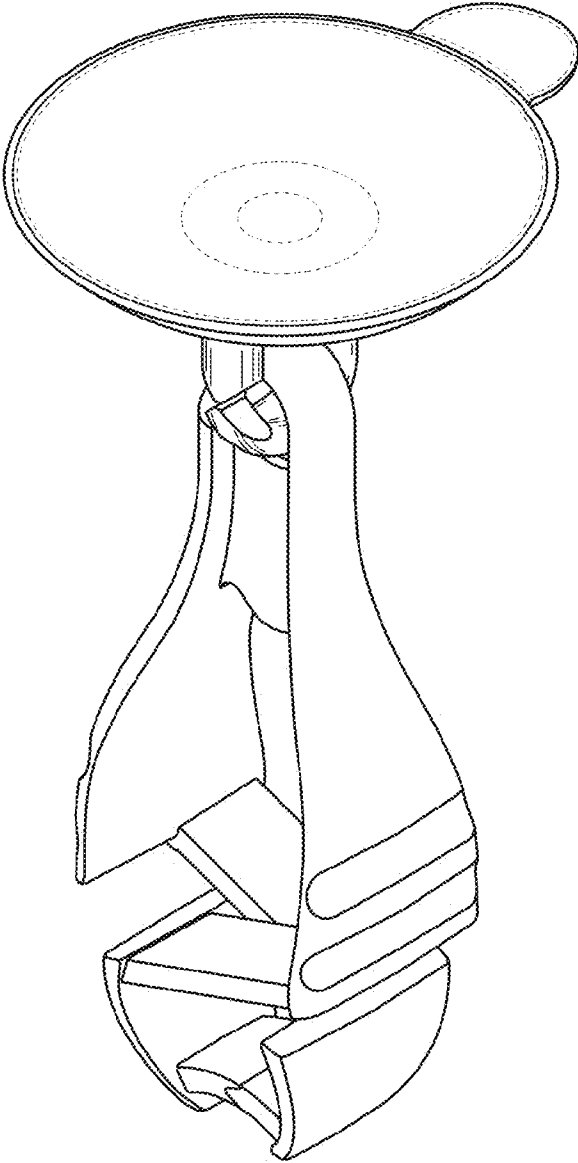

Fig. 1

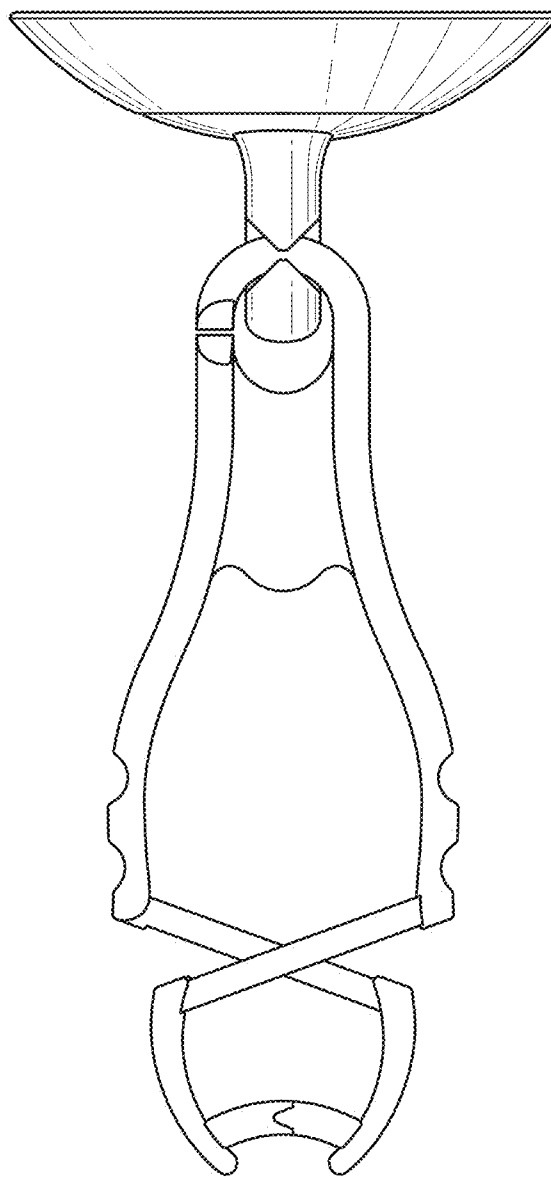

Fig. 2

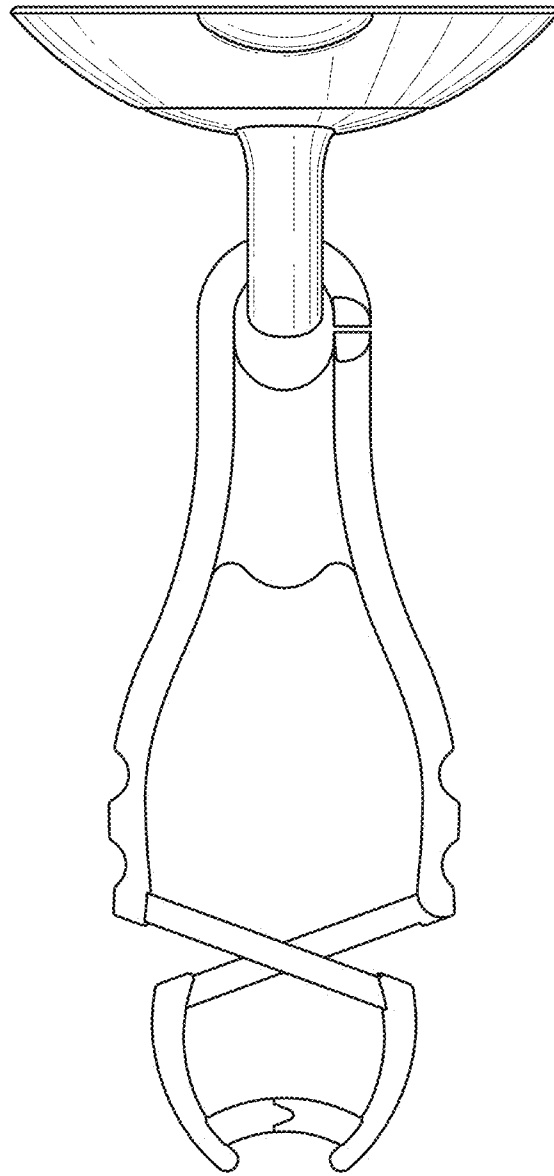

Fig. 3

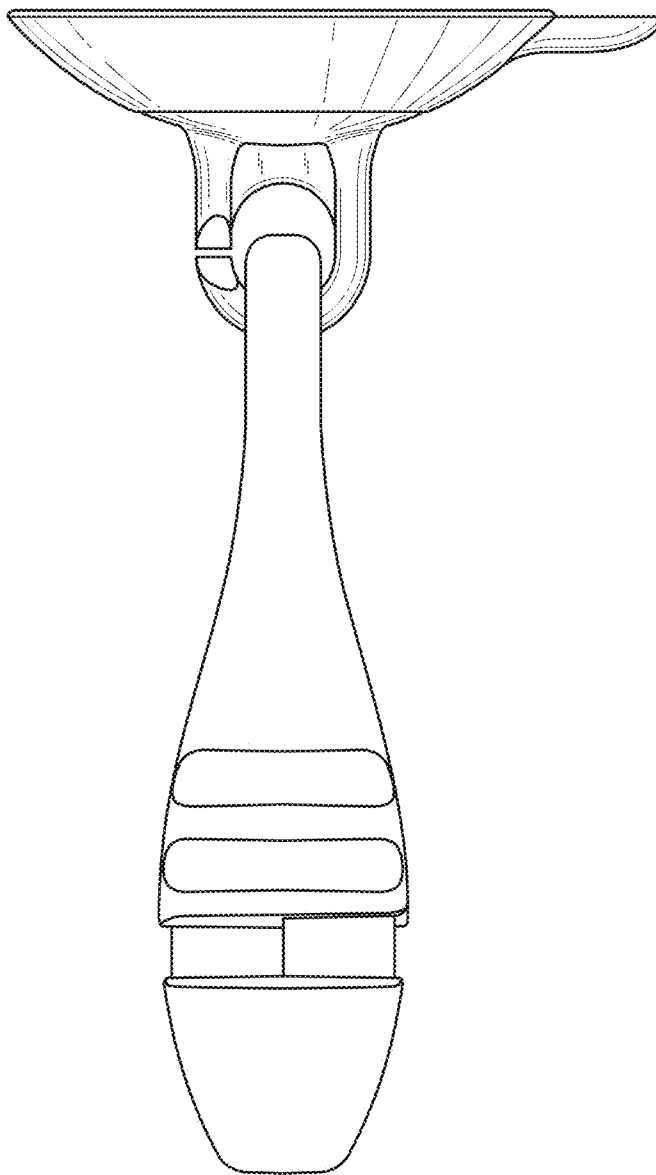

Fig. 4

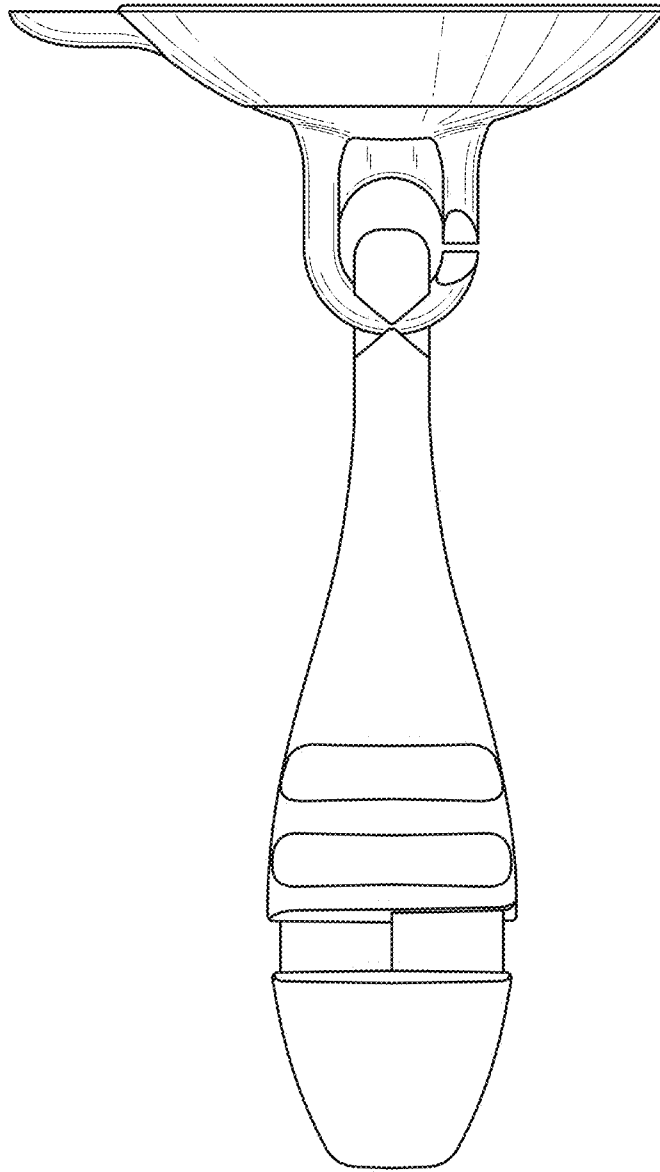

Fig. 5

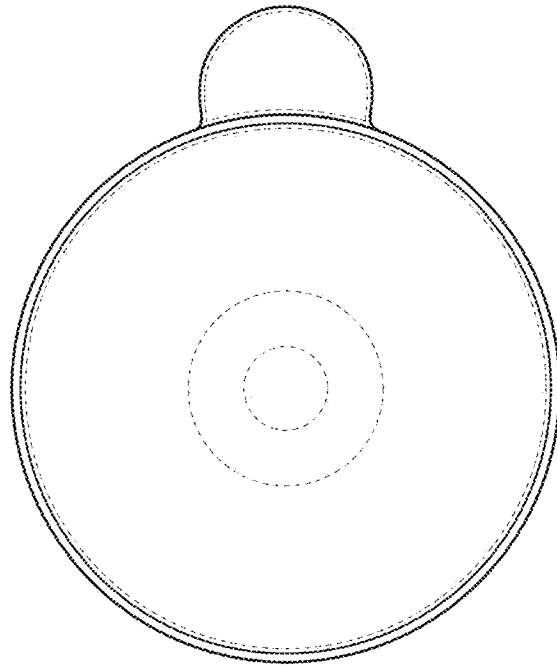

Fig. 6

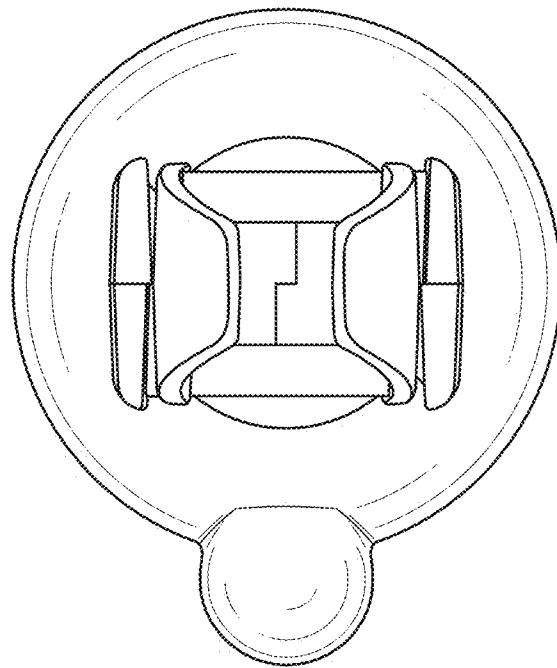

Fig. 7