



US00D794624S

(12) **United States Design Patent** (10) **Patent No.:** **US D794,624 S**
Fernandes et al. (45) **Date of Patent:** **** Aug. 15, 2017**

(54) **CASE FOR AN ELECTRONIC DEVICE** 8,442,604 B1 * 5/2013 Diebel G03B 17/02
361/679.32
(71) Applicant: **i-Blades, Inc.**, Danville, CA (US) D709,439 S * 7/2014 Ferber D13/103
2009/0186264 A1 * 7/2009 Huang H01M 2/1022
429/96

(72) Inventors: **Jorge M. Fernandes**, Danville, CA (US); **Paul Meissner**, San Jose, CA (US); **Nick Osborne**, Los Altos Hills, CA (US)

(Continued)

Primary Examiner — Freda S Nunn
(74) *Attorney, Agent, or Firm* — Kilpatrick Townsend & Stockton LLP

(73) Assignee: **I-BLADES, INC.**, Milpitas, CA (US)

(**) Term: **15 Years**

(21) Appl. No.: **29/537,295**

(57) **CLAIM**

The ornamental design for a case for an electronic device, as shown and described.

(22) Filed: **Aug. 24, 2015**

(51) **LOC (10) Cl.** **14-03**

(52) **U.S. Cl.**
USPC **D14/250**

(58) **Field of Classification Search**

USPC D14/250, 341–347, 130, 138 C, 138 G, D14/138 R, 138 AA, 147, 203.1, 203.3, D14/203.7, 204.4; D3/218
CPC A45C 1/06; A45C 11/00; A45C 2011/002; A45C 3/02; A45F 2200/0525; A45F 2200/0516; A45F 5/02; G06F 1/165; G06F 1/1613; G06F 1/1624; G06F 1/1626; G06F 3/0485; G06F 3/0488; G06F 1/1632; G06F 1/1607; G06F 1/1628; G06F 1/1656; H04B 1/3888; H04B 1/00; H04B 1/3883; H04M 1/0202; H04M 1/0283; H04M 1/185; H04M 1/00; H04M 1/0214; H04M 1/035; H04M 1/04; H01M 10/46; H01M 2/1022; H05K 5/0217; H05K 5/03; H05K 7/00; H05K 5/0086; B29C 45/1676; H02J 7/00; H04Q 7/32; B65D 85/00; B65D 19/00; G03B 17/02

See application file for complete search history.

DESCRIPTION

FIG. 1 is an exploded view of a case for an electronic device showing our new design;
FIG. 2 is a perspective view thereof wherein a removable panel is attached;
FIG. 3 is a perspective view thereof wherein the removable panel is removed;
FIG. 4 is a front elevational view thereof;
FIG. 5 is a left side elevational view thereof;
FIG. 6 is a top plan view thereof;
FIG. 7 is a rear elevational view thereof;
FIG. 8 is a right side elevational view thereof;
FIG. 9 is a bottom plan view thereof;
FIG. 10 is a perspective view of the removable panel thereof shown separately for clarity of illustration;
FIG. 11 is a top plan view thereof;
FIG. 12 is a front elevational view thereof;
FIG. 13 is a bottom plan view thereof;
FIG. 14 is a rear elevational view thereof;
FIG. 15 is a left side elevational view thereof; and,
FIG. 16 is a right side elevational view thereof.
The portions shown in broken lines form no part of the claimed design.

(56) **References Cited**

U.S. PATENT DOCUMENTS

D603,603 S * 11/2009 Laine D3/218
D622,716 S * 8/2010 Andre D14/250

1 Claim, 6 Drawing Sheets

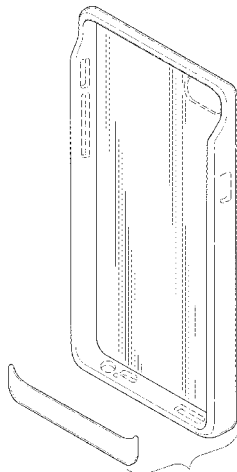

(56)

References Cited

U.S. PATENT DOCUMENTS

2014/0224675	A1*	8/2014	Simmer	A45C 11/00 206/37
2014/0274232	A1*	9/2014	Tages	H04B 1/3888 455/575.8

* cited by examiner

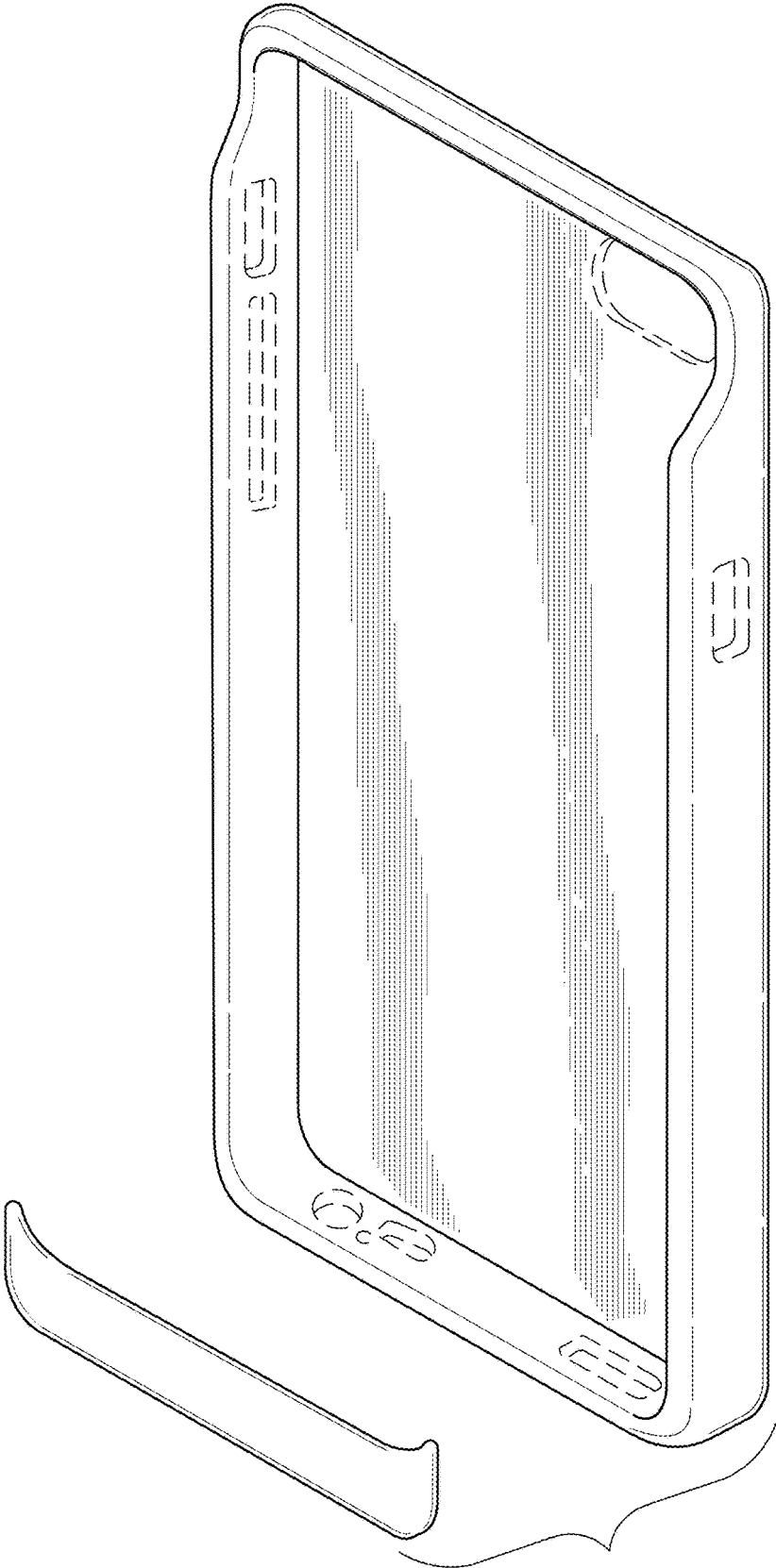

FIG. 1

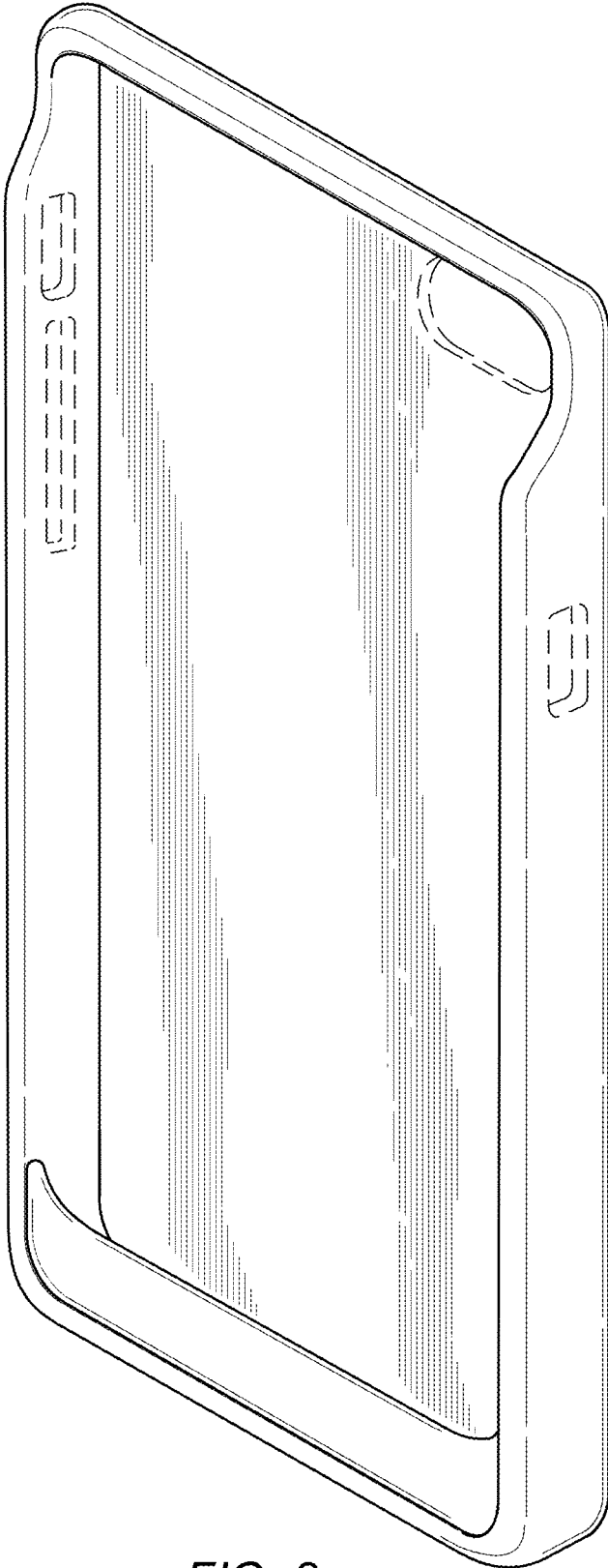

FIG. 2

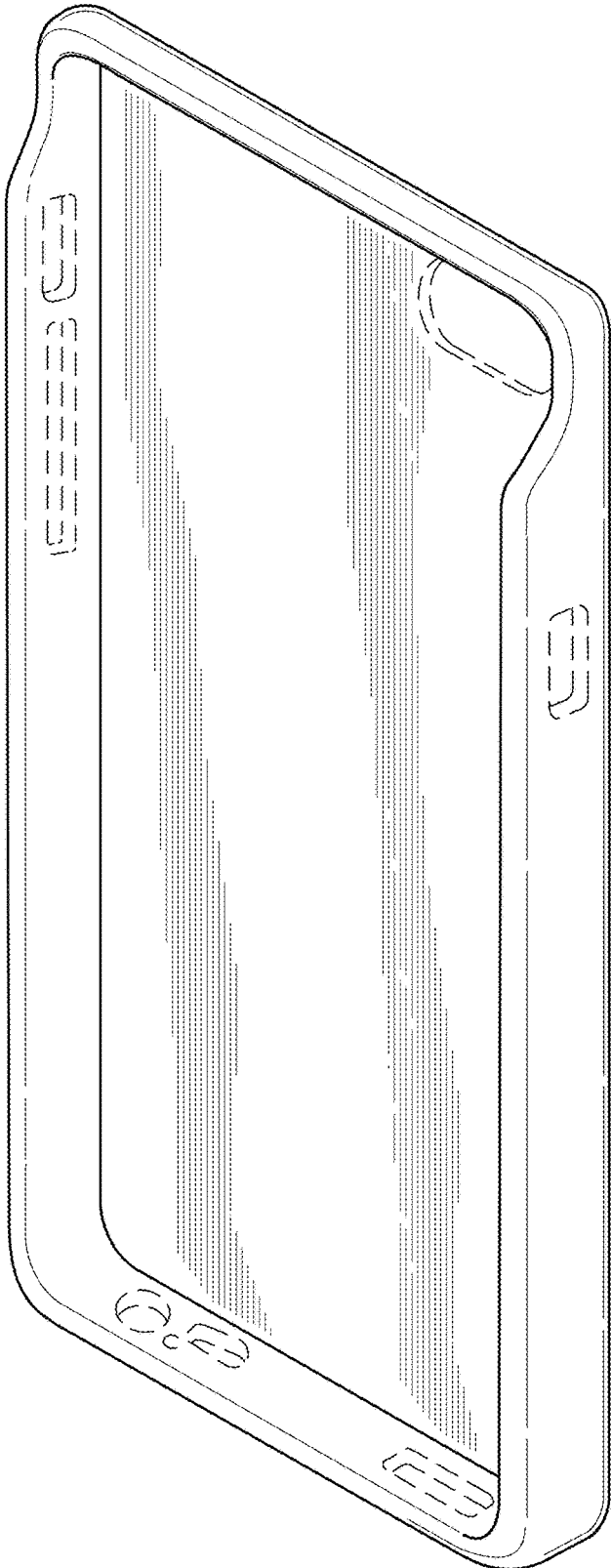

FIG. 3

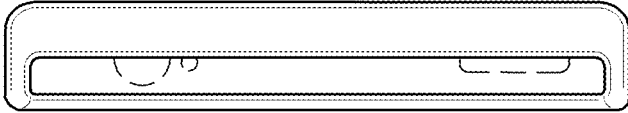

FIG. 6

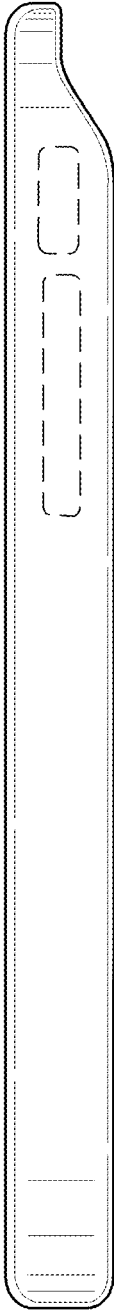

FIG. 5

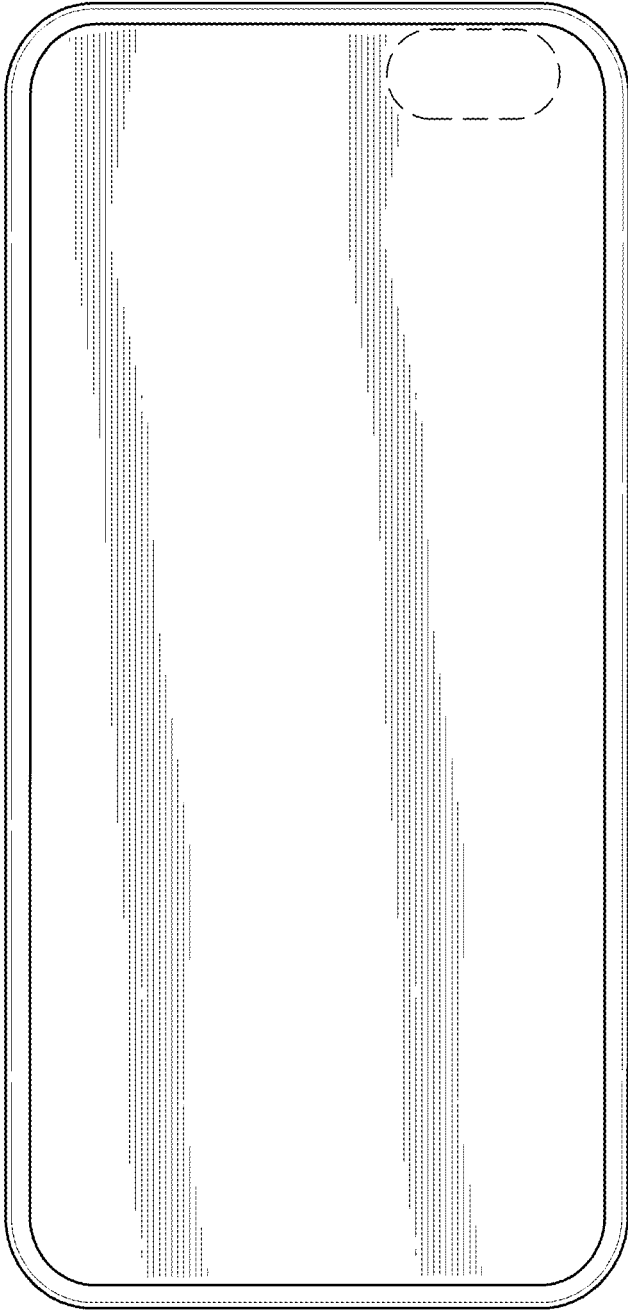

FIG. 4

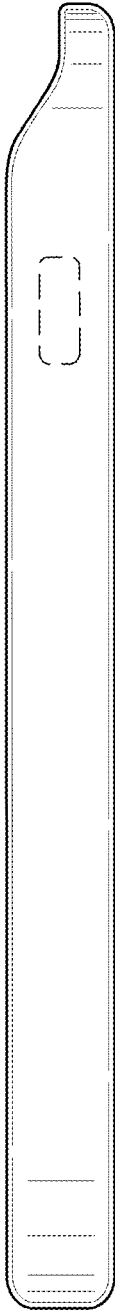

FIG. 8

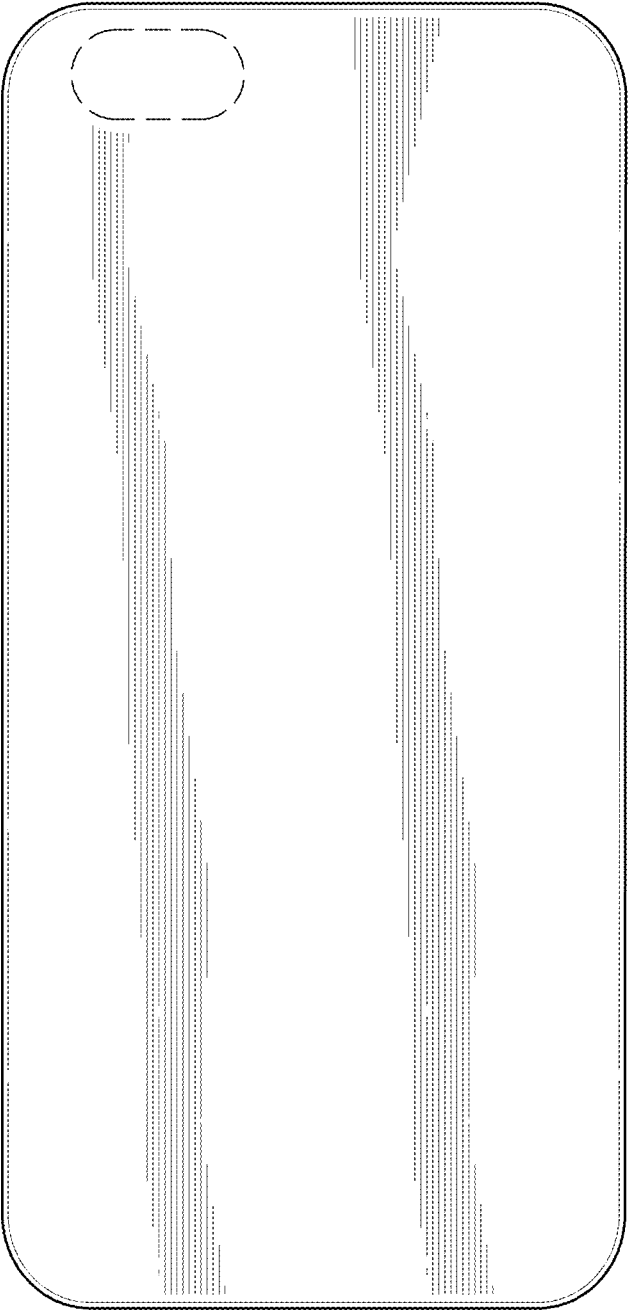

FIG. 7



FIG. 9

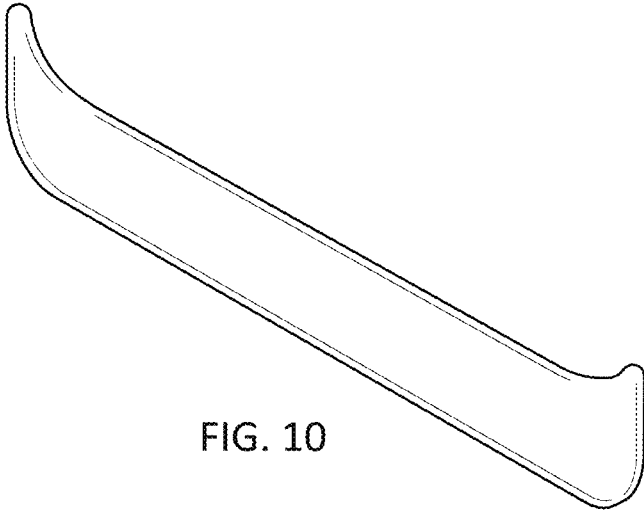

FIG. 10



FIG. 11

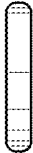

FIG. 15

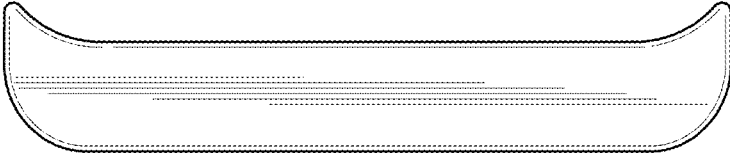

FIG. 12



FIG. 16



FIG. 13

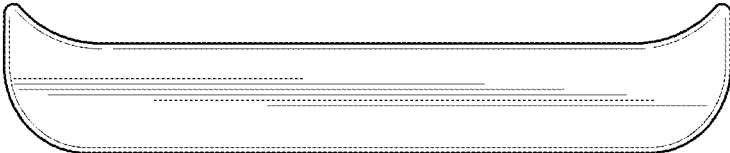

FIG. 14