



US00D766622S

(12) **United States Design Patent**
Juhasz et al.

(10) **Patent No.:** **US D766,622 S**

(45) **Date of Patent:** **** Sep. 20, 2016**

(54) **SUPPORT CUSHION**
(71) Applicant: **HoMEDICS USA, LLC**, Commerce Township, MI (US)
(72) Inventors: **Andrew S. Juhasz**, Ajax (CA); **Jerry Fontyn**, Cambridge (CA)
(73) Assignee: **HoMedics USA, LLC**, Commerce Township, MI (US)

3,740,096 A 6/1973 Bridger
D292,767 S * 11/1987 Challen D6/596
D294,900 S 3/1988 Willingham
5,887,951 A 3/1999 Willingham
5,997,095 A 12/1999 Powell et al.
6,336,895 B1 1/2002 Dukes
7,216,388 B2 5/2007 Bieganeck et al.
D549,031 S * 8/2007 Berkson D6/601
7,607,738 B2 10/2009 Gregory et al.

(Continued)

Primary Examiner — Mary Ann Calabrese

(74) *Attorney, Agent, or Firm* — Brooks Kushman P.C.

(**) Term: **14 Years**

(21) Appl. No.: **29/503,670**

(22) Filed: **Sep. 29, 2014**

(51) **LOC (10) Cl.** **06-09**

(52) **U.S. Cl.**
USPC **D6/601**

(58) **Field of Classification Search**
USPC D6/595–601, 604; D21/803, 804; D24/183
CPC A47C 7/021; A47C 7/022; A47C 7/425; A47C 7/383; A47C 7/46; A47C 3/12; A47C 3/16; A47C 20/00; A47C 20/21; A47C 20/25; A47D 13/00; A47D 13/08; A47G 9/00; A47G 9/10; A47G 9/1027; A47G 9/1036; A47G 9/1045; A47G 9/1054; A47G 9/1063; A47G 9/1072; A47G 9/1081; A47G 9/109; A47G 2009/003; A47G 2009/1018; A47G 2009/1036; A61F 5/01; A62B 9/06; B68G 11/03; B60N 2/70
See application file for complete search history.

(56) **References Cited**

U.S. PATENT DOCUMENTS

D131,142 S * 1/1942 Bostrom D6/596
3,138,404 A 6/1964 Newton

(57) **CLAIM**

The ornamental design for a support cushion, as shown and described.

DESCRIPTION

FIG. 1 is a perspective view of a support cushion according to an embodiment;
FIG. 2 is a left side view of the support cushion of FIG. 1;
FIG. 3 is a right side view of the support cushion of FIG. 1;
FIG. 4 is a front view of the support cushion of FIG. 1;
FIG. 5 is a rear view of the support cushion of FIG. 1;
FIG. 6 is a top view of the support cushion of FIG. 1;
FIG. 7 is a bottom view of the support cushion of FIG. 1;
FIG. 8 is a perspective view of a support cushion according to another embodiment;
FIG. 9 is a left side view of the support cushion of FIG. 8;
FIG. 10 is a right side view of the support cushion of FIG. 8;
FIG. 11 is a front view of the support cushion of FIG. 8;
FIG. 12 is a rear view of the support cushion of FIG. 8;
FIG. 13 is a top view of the support cushion of FIG. 8; and
FIG. 14 is a bottom view of the support cushion of FIG. 8.

1 Claim, 6 Drawing Sheets

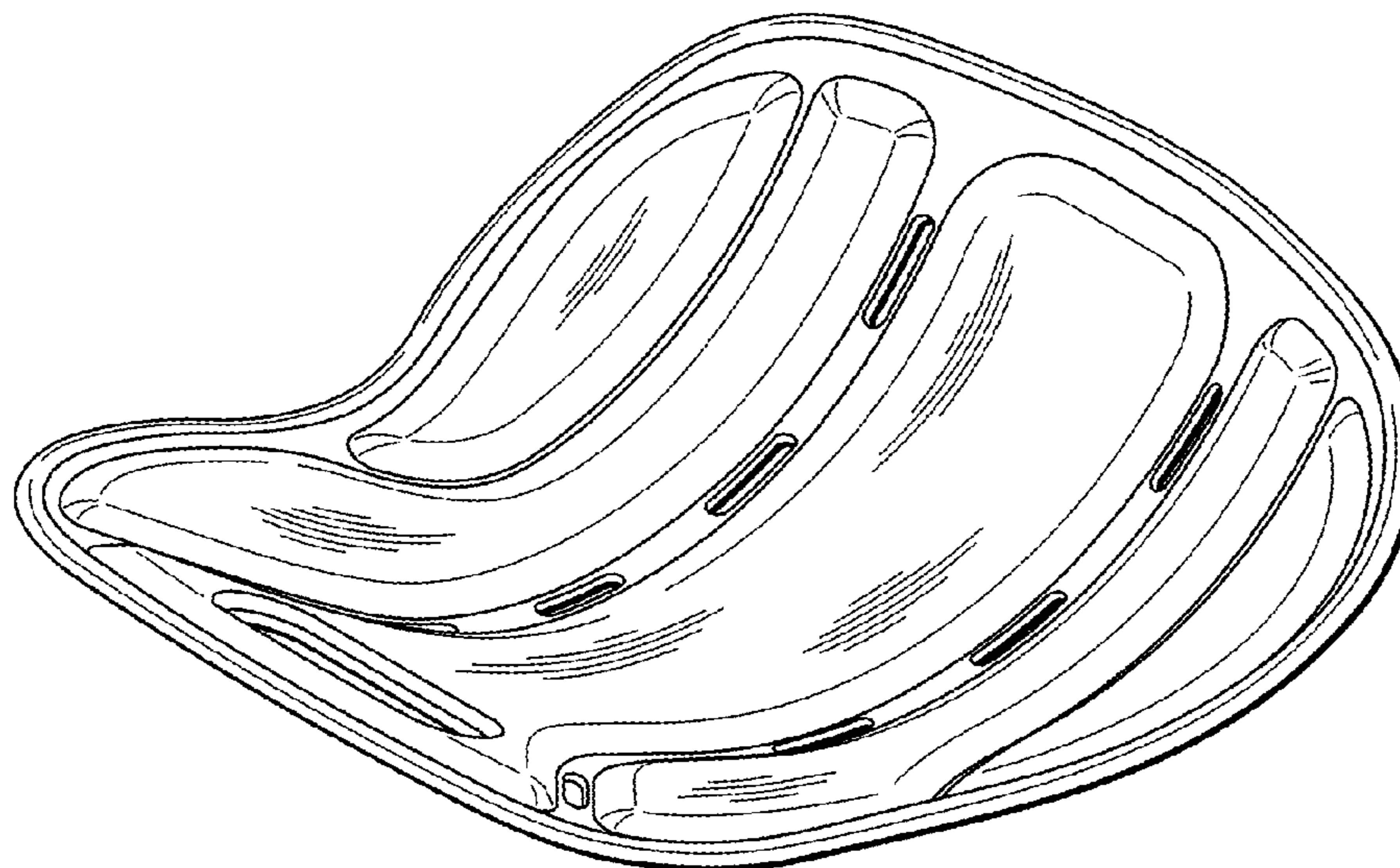

(56)

References Cited

U.S. PATENT DOCUMENTS

D686,684 S * 7/2013 Wolfinbarger D21/803
8,671,482 B2 3/2014 Willingham
D735,495 S * 8/2015 Pong D6/601

2005/0022305 A1 2/2005 Bieganeck et al.
2008/0092907 A1 4/2008 Walker
2010/0078979 A1 4/2010 Nemoto
2012/0299350 A1 11/2012 Willingham

* cited by examiner

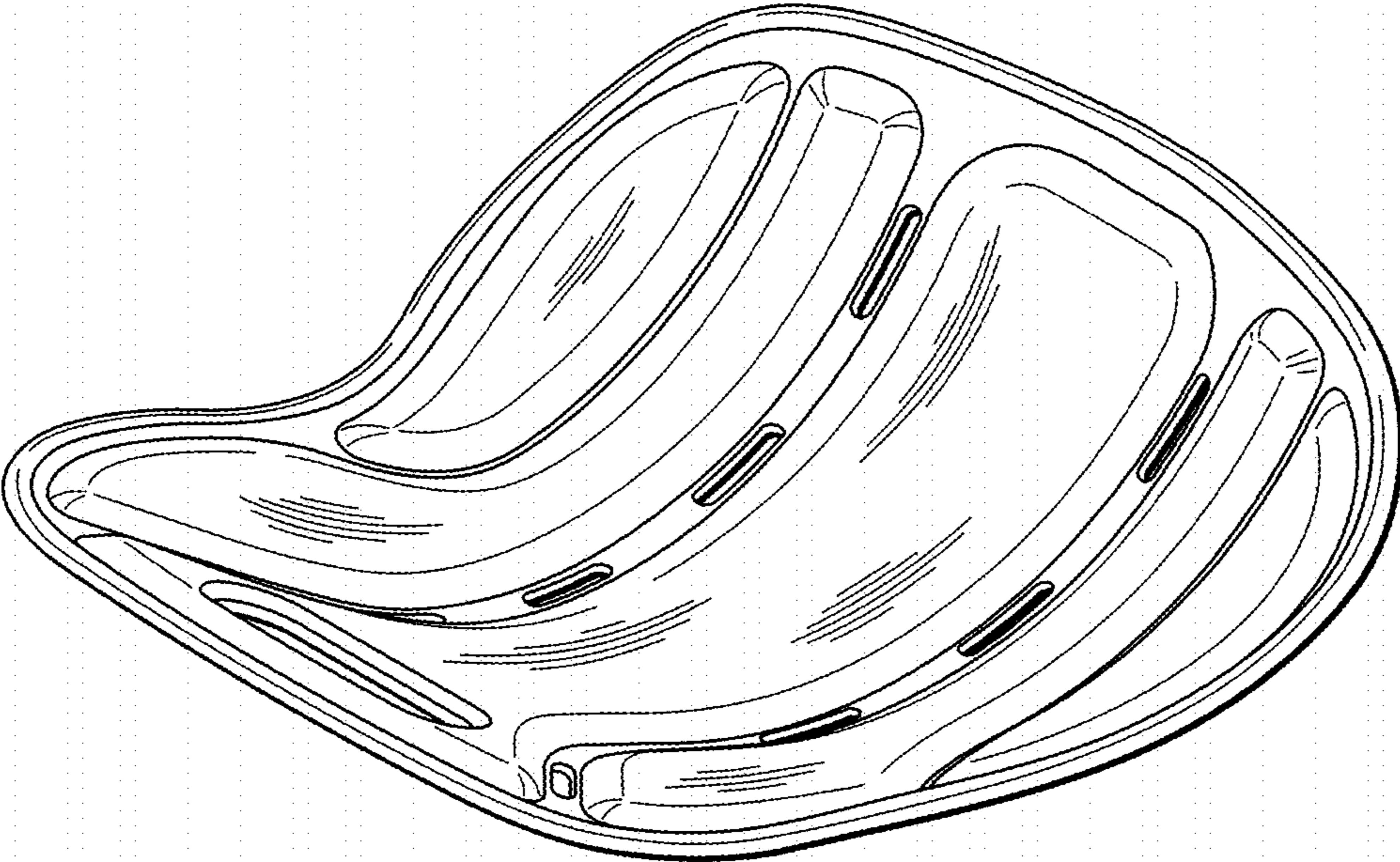

FIG. 1

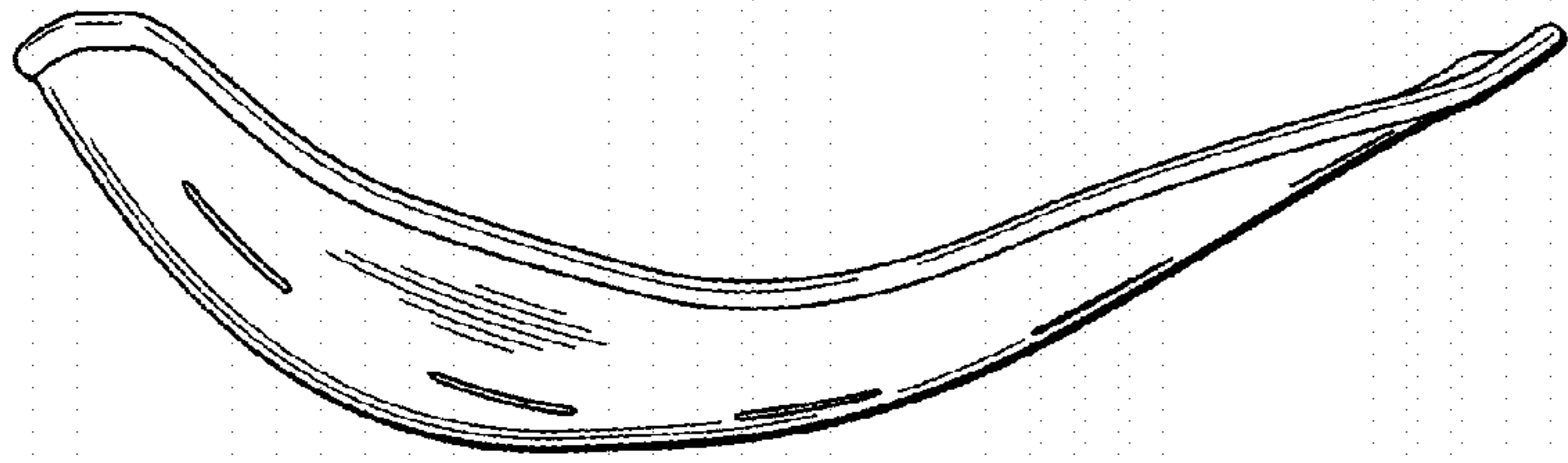

FIG. 2

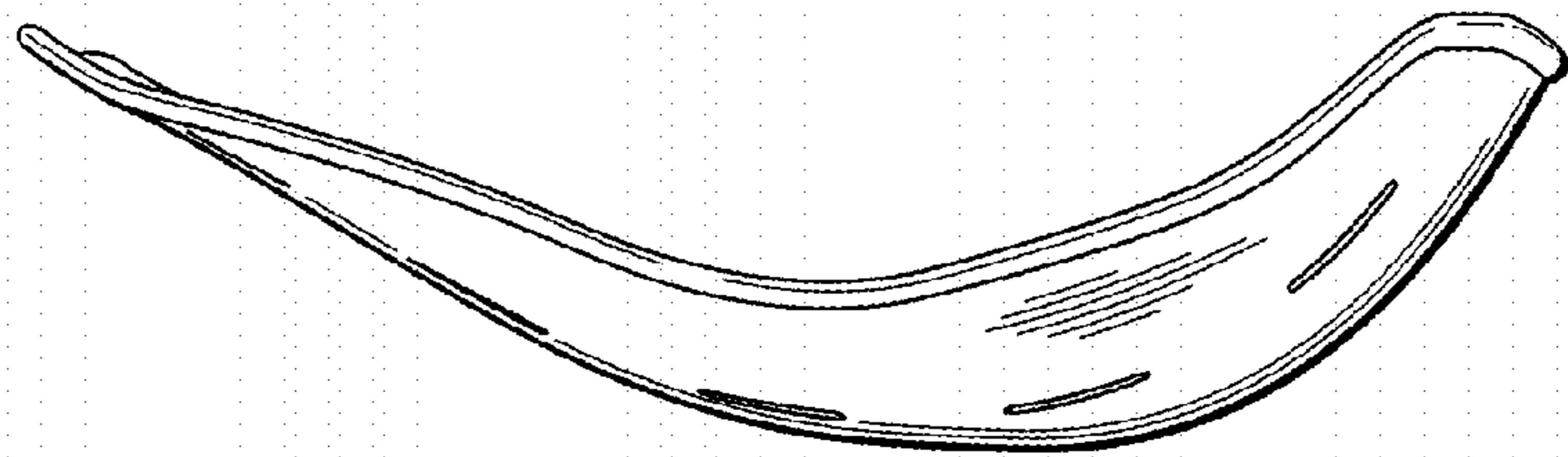

FIG. 3

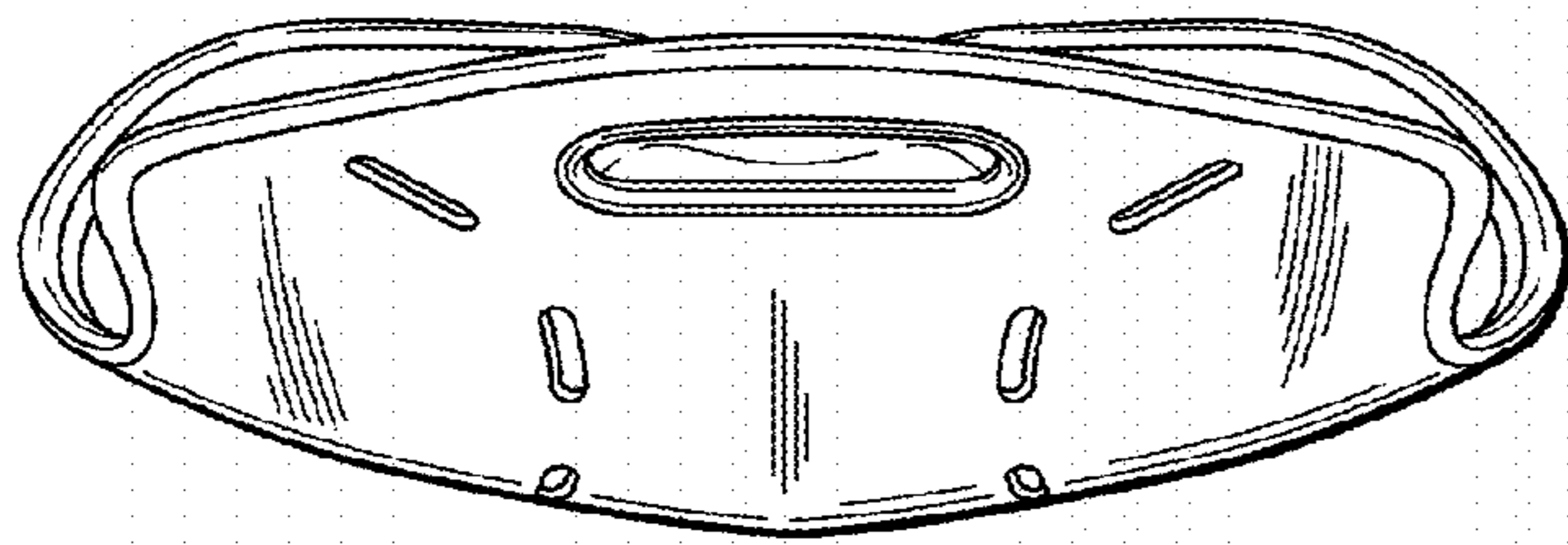

FIG. 4

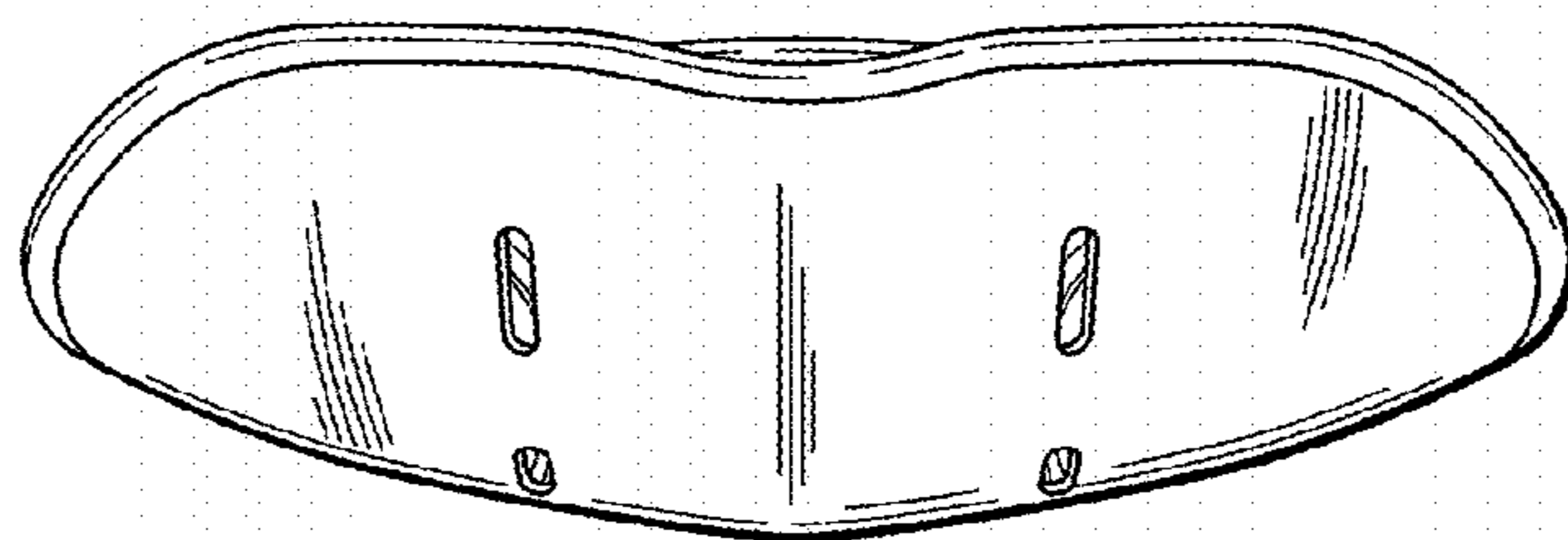

FIG. 5

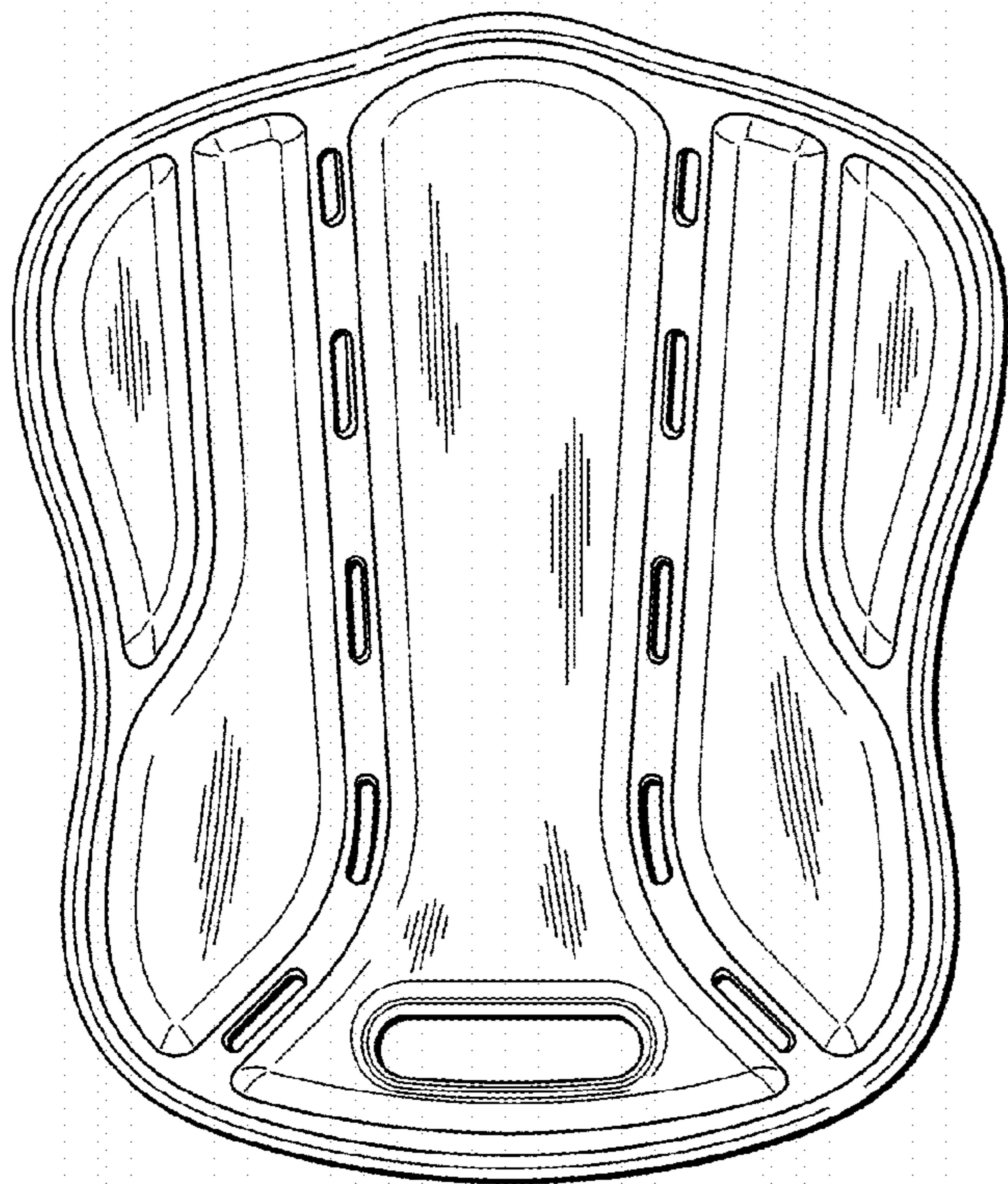

FIG. 6

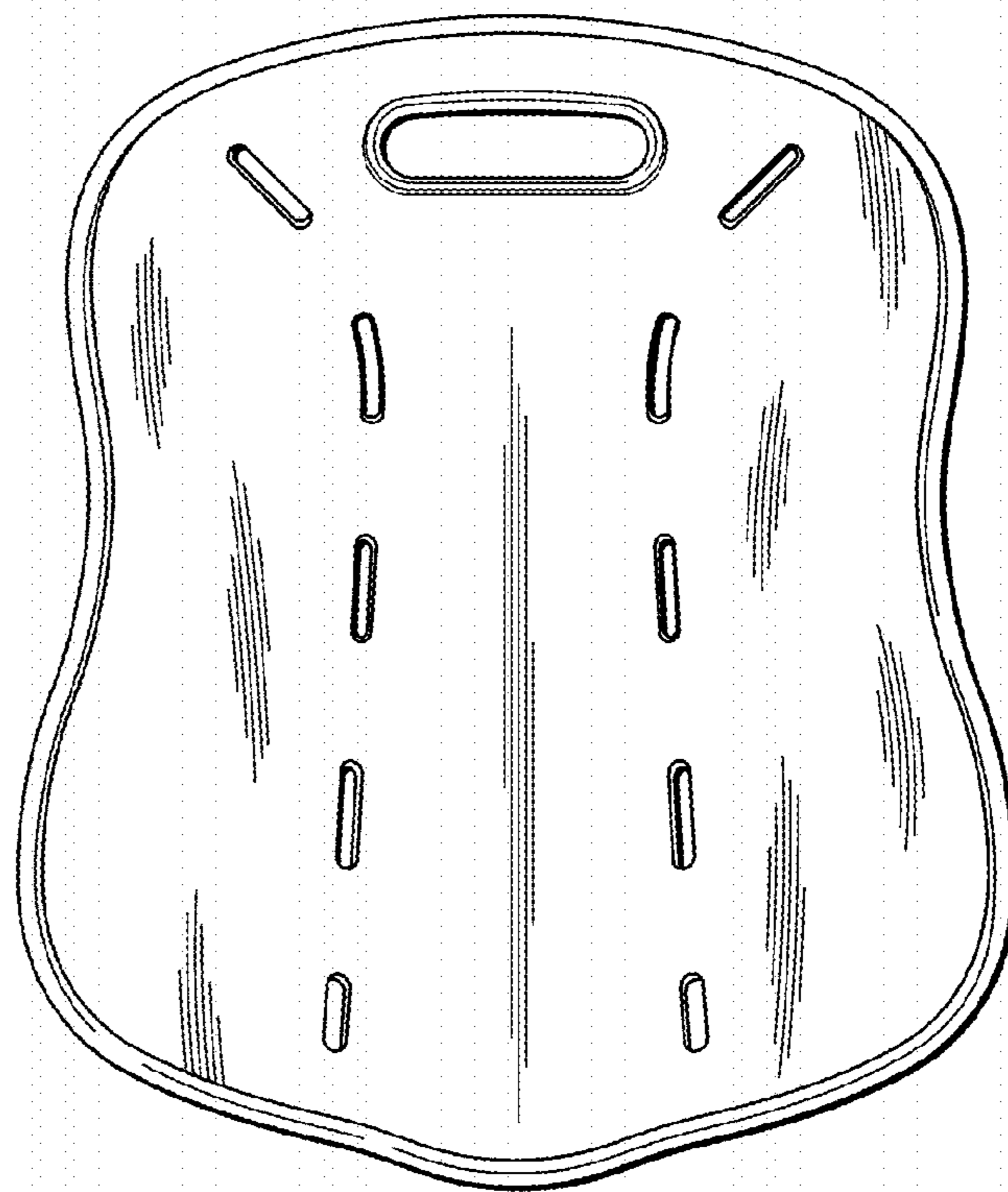

FIG. 7

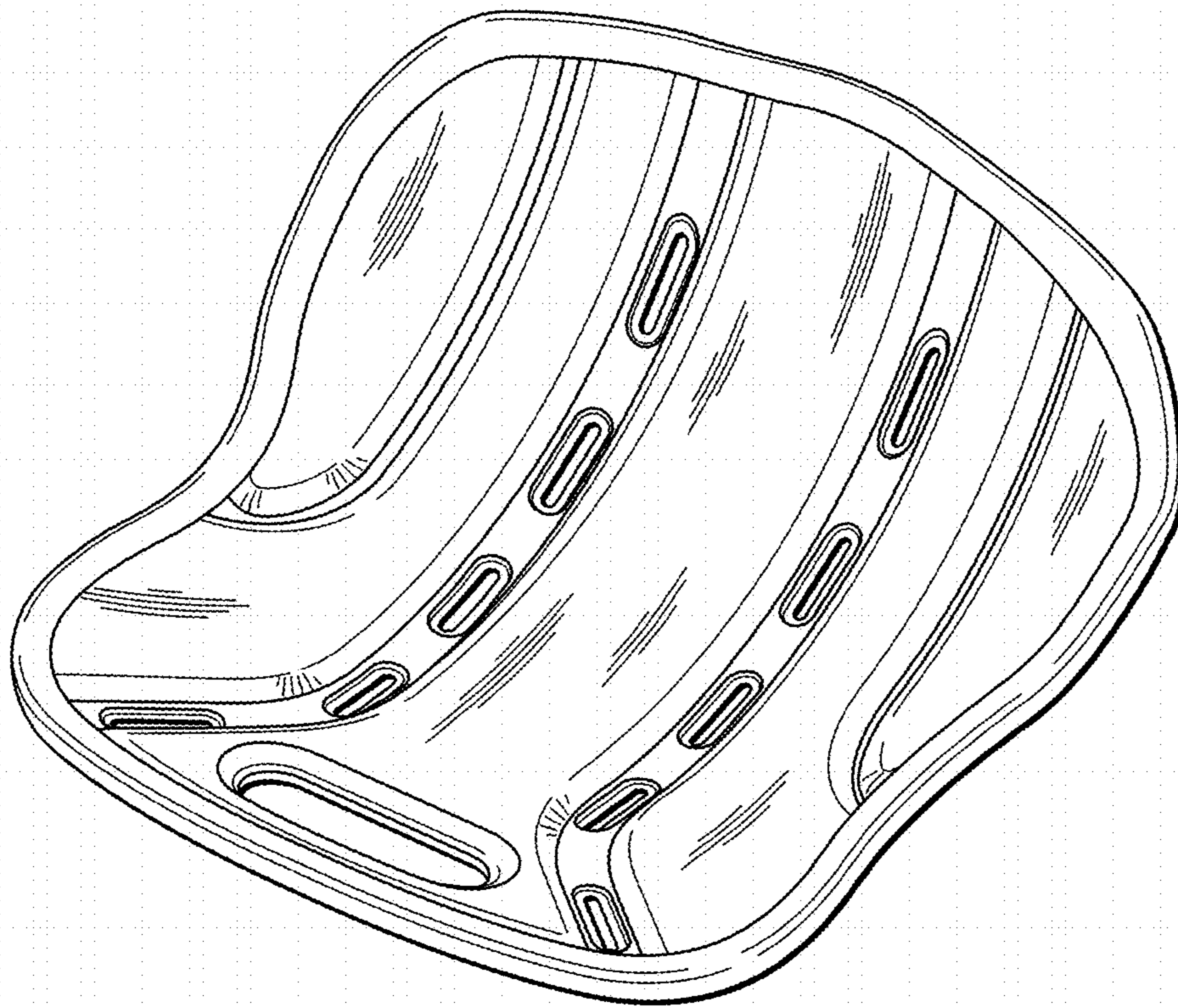

FIG. 8

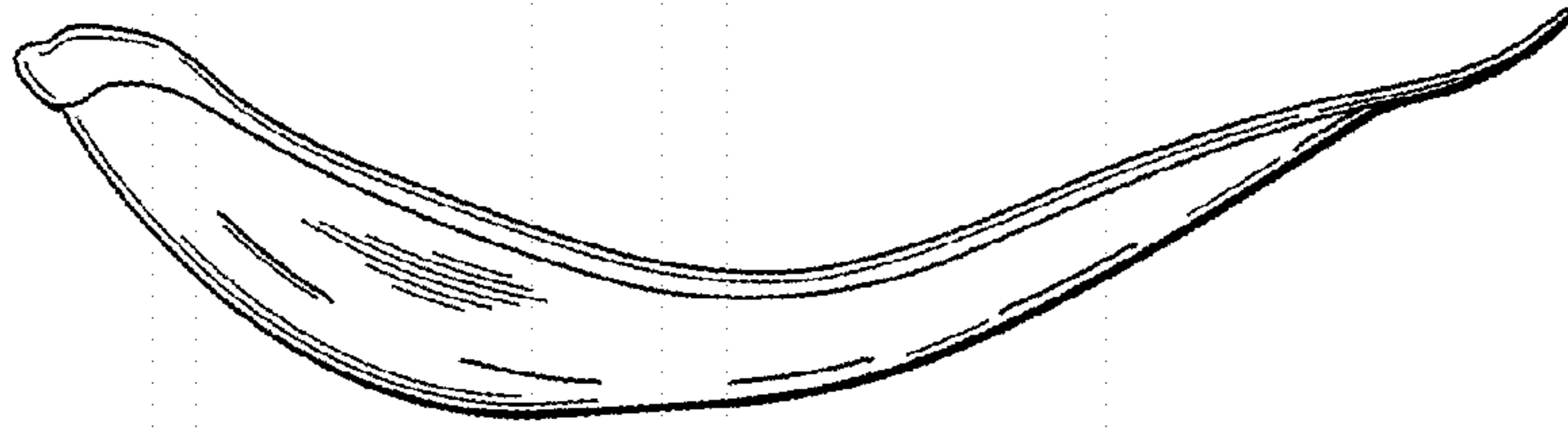

FIG. 9

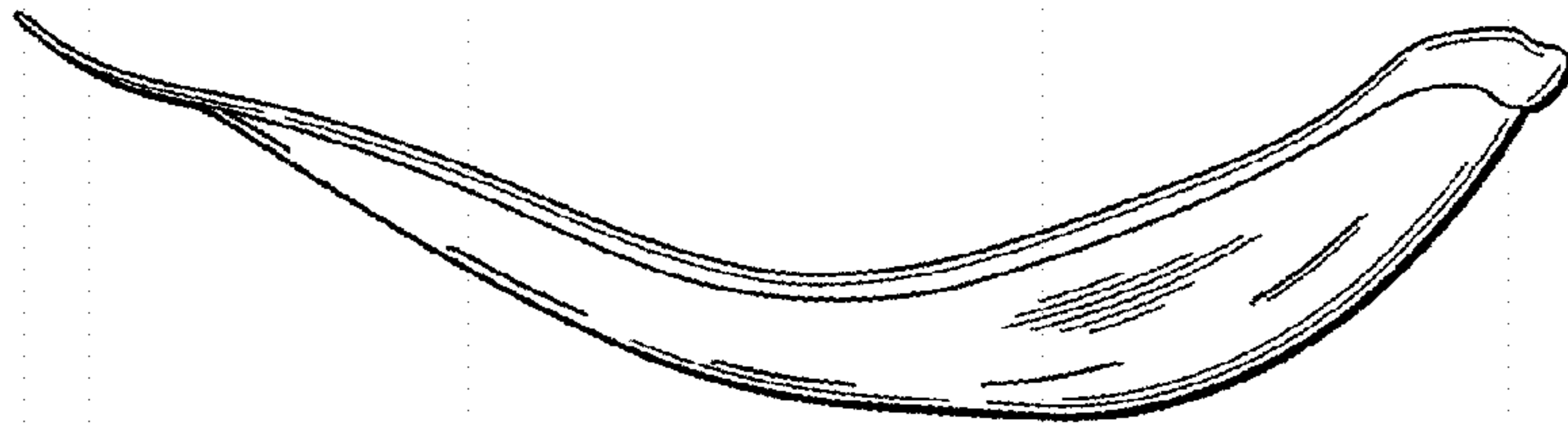

FIG. 10

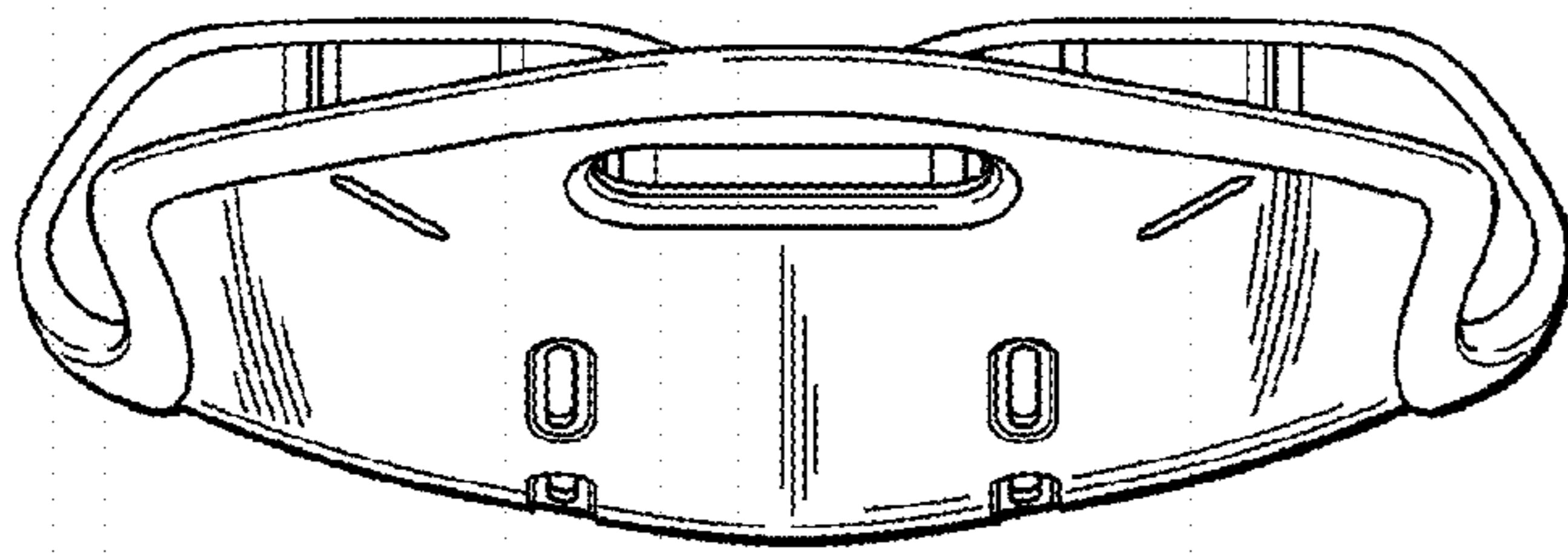

FIG. 11

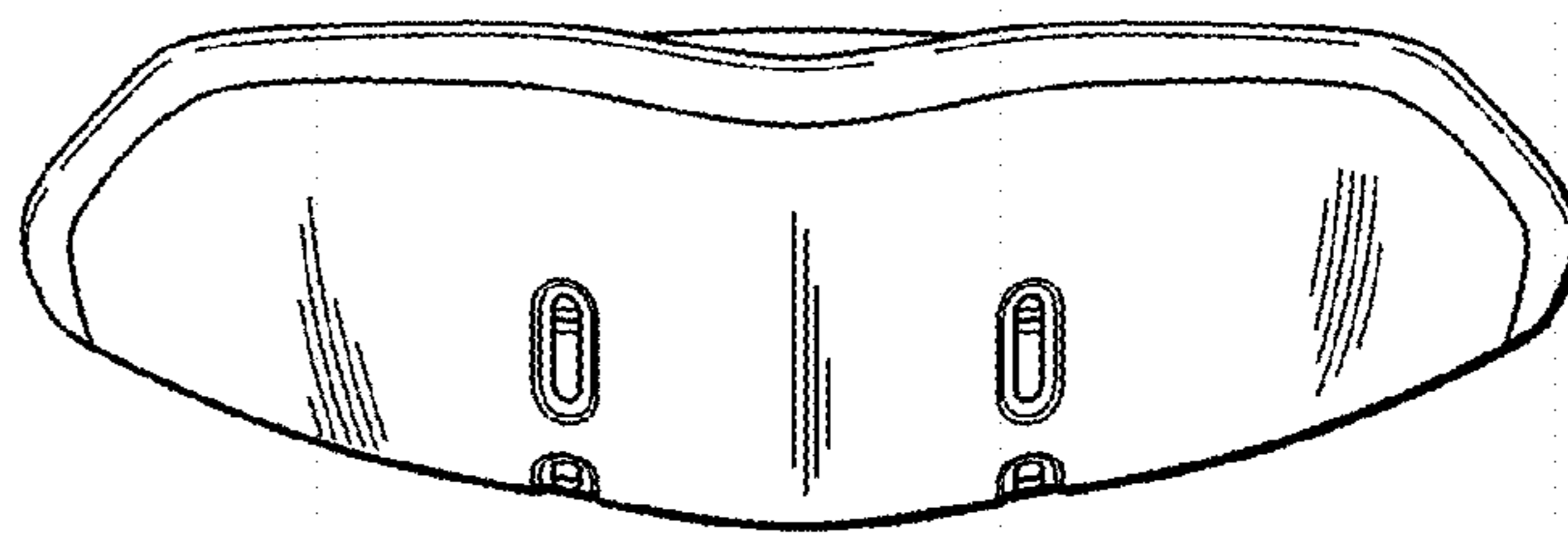

FIG. 12

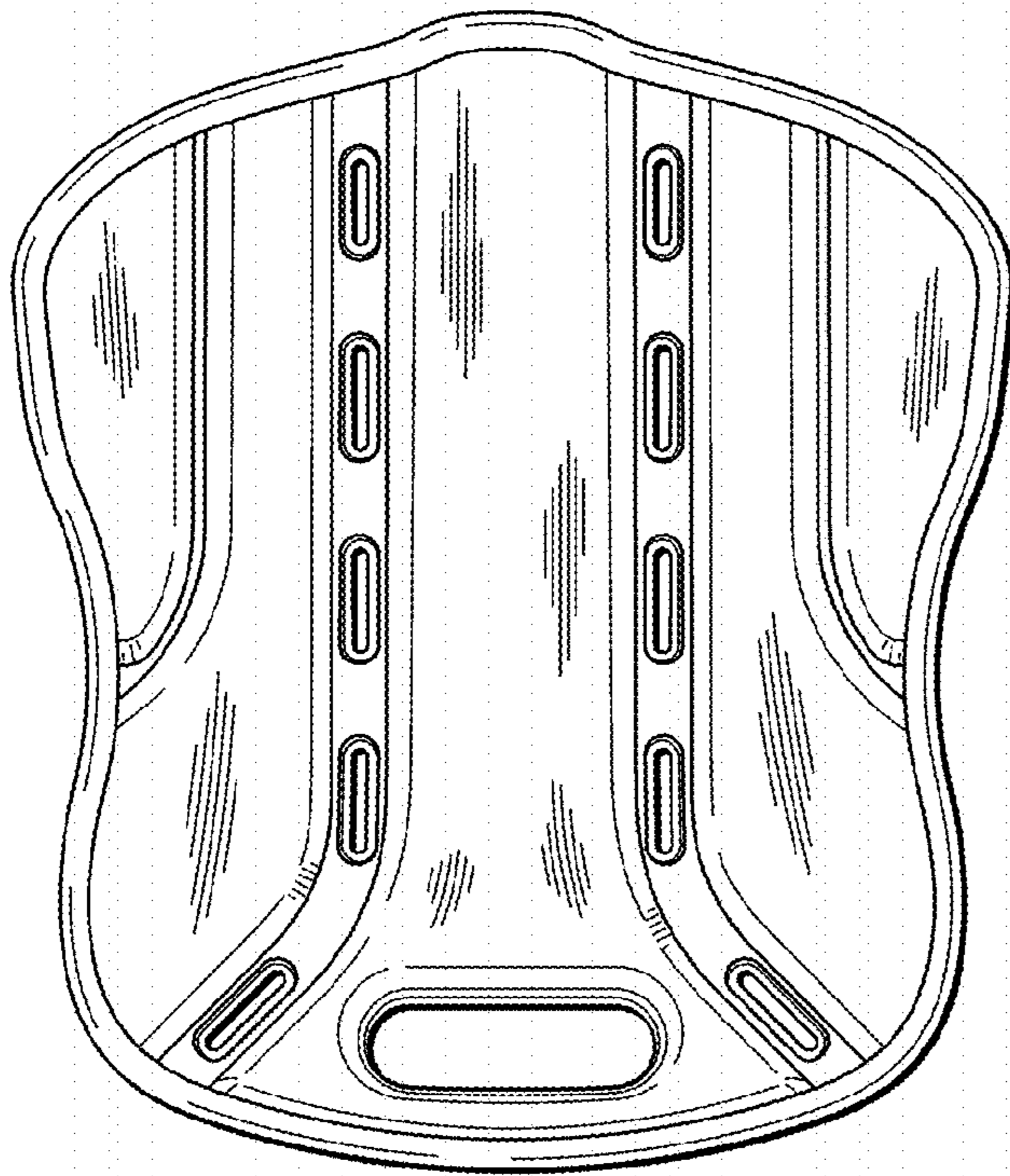

FIG. 13

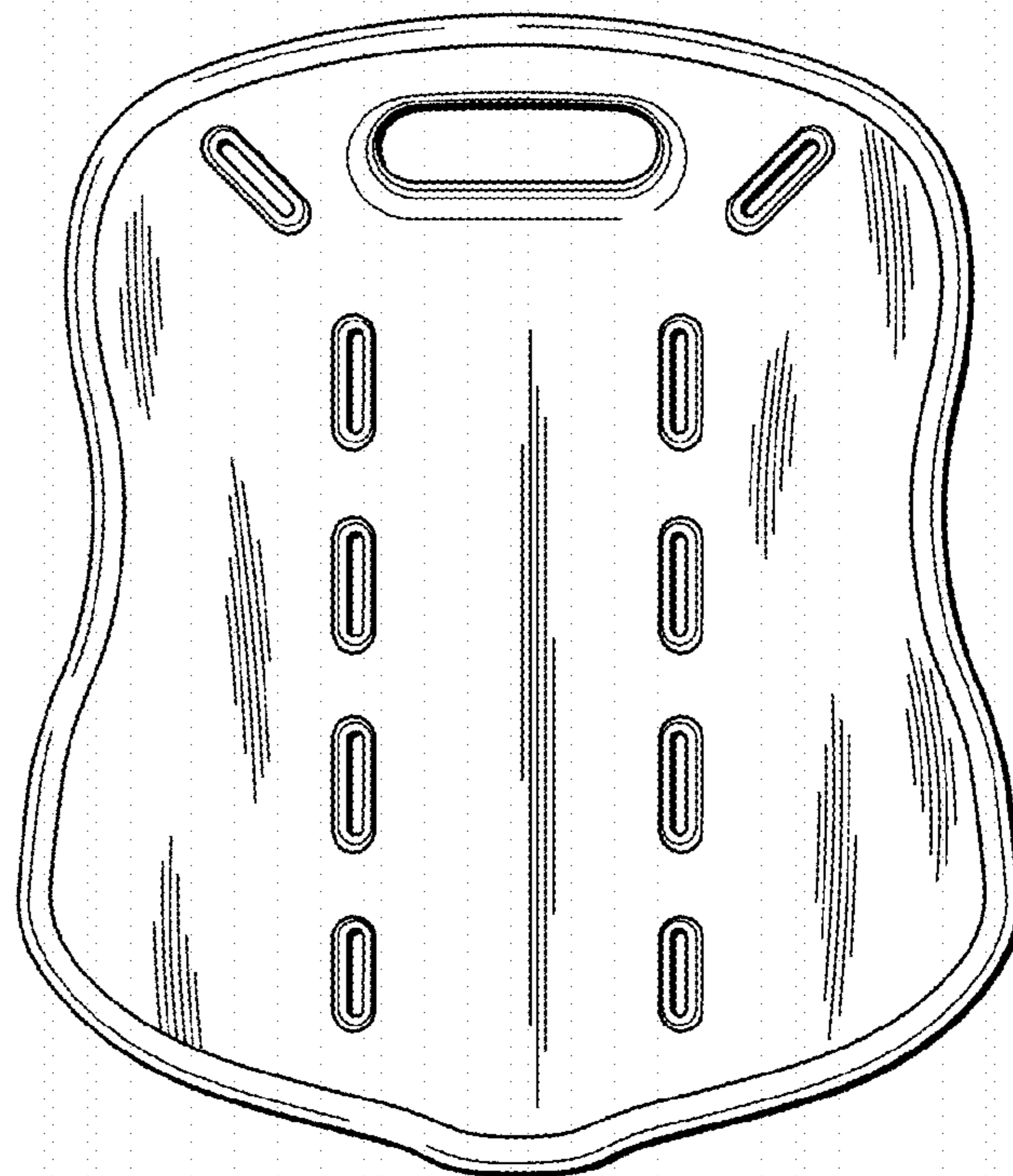

FIG. 14