



US00D996249S

(12) **United States Design Patent**
Giger et al.

(10) **Patent No.:** **US D996,249 S**
(45) **Date of Patent:** **** Aug. 22, 2023**

- (54) **PROTECTIVE COVER FOR A SENSOR**
- (71) Applicant: **Kistler Holding AG**, Winterthur (CH)
- (72) Inventors: **Martin Giger**, Winterthur (CH); **Philip Graf**, Weinfelden (CH); **Reinhold Buck**, Illnau (CH); **Kevin Hauenstein**, Baden (CH)
- (73) Assignee: **Kistler Holding AG**, Winterthur (CH)

D871,242 S *	12/2019	Fürer	D10/85
D874,303 S *	2/2020	Fürer	D10/85
D875,581 S *	2/2020	Fürer	D10/85
D877,635 S *	3/2020	Fürer	D10/85
D892,645 S *	8/2020	Lee	D10/50
D963,502 S *	9/2022	Kurani	D10/104.1
2021/0063264 A1	3/2021	Heer		

(**) Term: **15 Years**

(21) Appl. No.: **35/514,254**

(22) Filed: **Nov. 8, 2021**

(80) **Hague Agreement Data**

Int. Filing Date: **Nov. 8, 2021**
 Int. Reg. No.: **DM/218969**
 Int. Reg. Date: **Nov. 8, 2021**
 Int. Reg. Pub. Date: **May 13, 2022**

(51) **LOC (14) Cl.** **10-04**
 (52) **U.S. Cl.**

USPC **D10/103**

(58) **Field of Classification Search**

USPC ... D10/46, 50, 74, 85, 102, 103, 104.1, 126,
 D10/106.2, 106.3, 106.5, 106.6
 CPC G01L 19/14; G01L 19/069
 See application file for complete search history.

(56) **References Cited**

U.S. PATENT DOCUMENTS

D333,796 S *	3/1993	Bannon	D10/106.5
D419,476 S *	1/2000	Baker	D10/106.5
D537,744 S *	3/2007	Wu	D10/102
D601,444 S *	10/2009	Jones	D10/103
8,122,765 B2	2/2012	Brechbühl et al.		
D817,795 S *	5/2018	Fürer	D10/85
D830,856 S *	10/2018	Golnik	D10/103
D852,664 S *	7/2019	Bonke	D10/126
D870,577 S *	12/2019	Fürer	D10/85
D870,578 S *	12/2019	Fürer	D10/85

FOREIGN PATENT DOCUMENTS

WO WO2019137772 7/2019

OTHER PUBLICATIONS

Kistler Gruppe, PiezoStar Pressure Sensor, M5x0,5 (U67), Datasheet 200.035.978—c, Winterthur, Schweiz, 2021, pp. 1-2.
 Kistler Gruppe, Compact M5 Cylinder Pressure Sensor, Minimal mounting space required, Datasheet 6054BR_003-046e-11.19, Winterthur, Schweiz, 2013-2019, pp. 1-4.
 Kistler Gruppe, PiezoStar Pressure Sensor, M5x0,5 (U59), Specification Control Sheet, Datasheet 6054BRU59-01e-c-YS1, Winterthur, Schweiz, pp. 1-5.
 Kistler Gruppe, Compact M5 Cylinder Pressure Sensor, Many development challenges—one sensor, Datasheet 6054C_003-458e-11.2, Winterthur, Schweiz, 2019-2021, pp. 1-4.

* cited by examiner

Primary Examiner — George D. Kirschbaum

Assistant Examiner — Lillian Windham

(74) *Attorney, Agent, or Firm* — Dority & Manning, P.A.

(57) **CLAIM**

The ornamental design for a protective cover for a sensor, as shown and described.

DESCRIPTION

1. Protective cover for a sensor

- 1.1** is a top view;
- 1.2** is a rear view;
- 1.3** is a left side view;
- 1.4** is a rear perspective view;
- 1.5** is a front view; and
- 1.6** is a front perspective view.

1 Claim, 6 Drawing Sheets

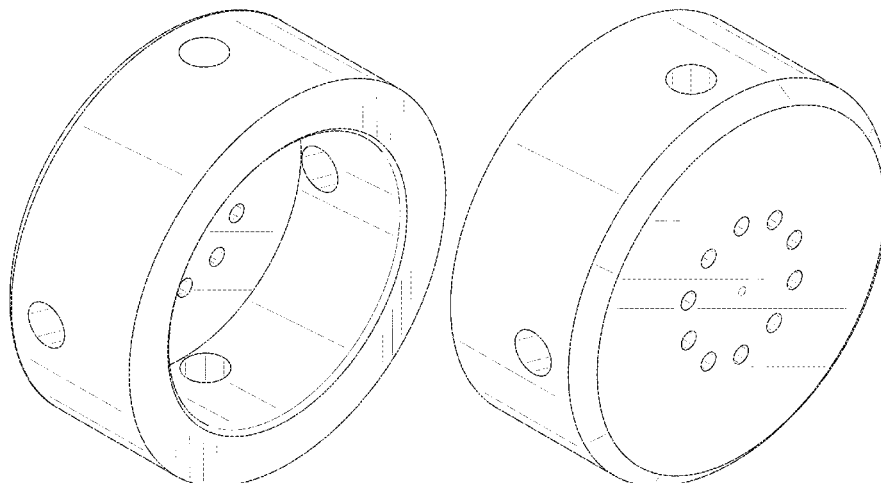

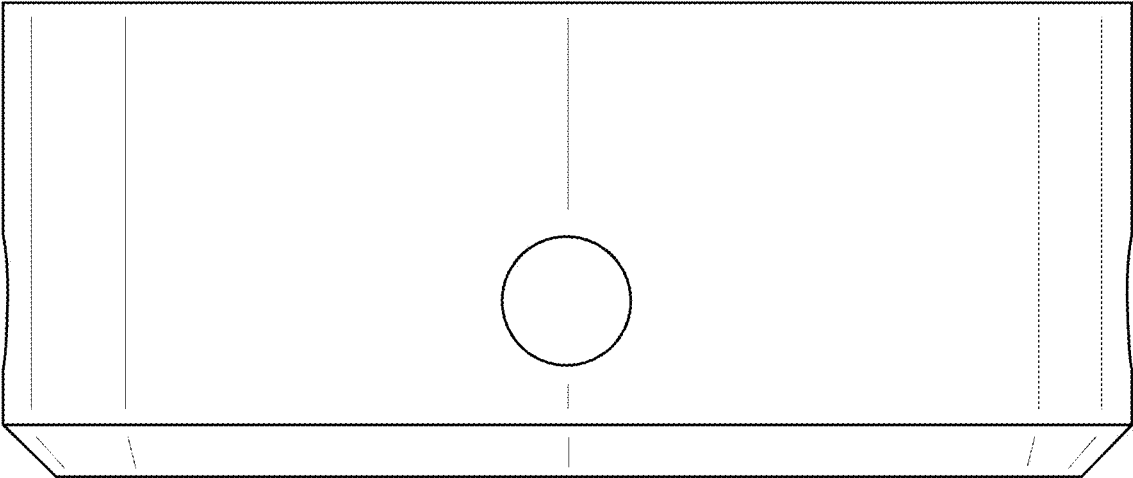

FIG. 1.1

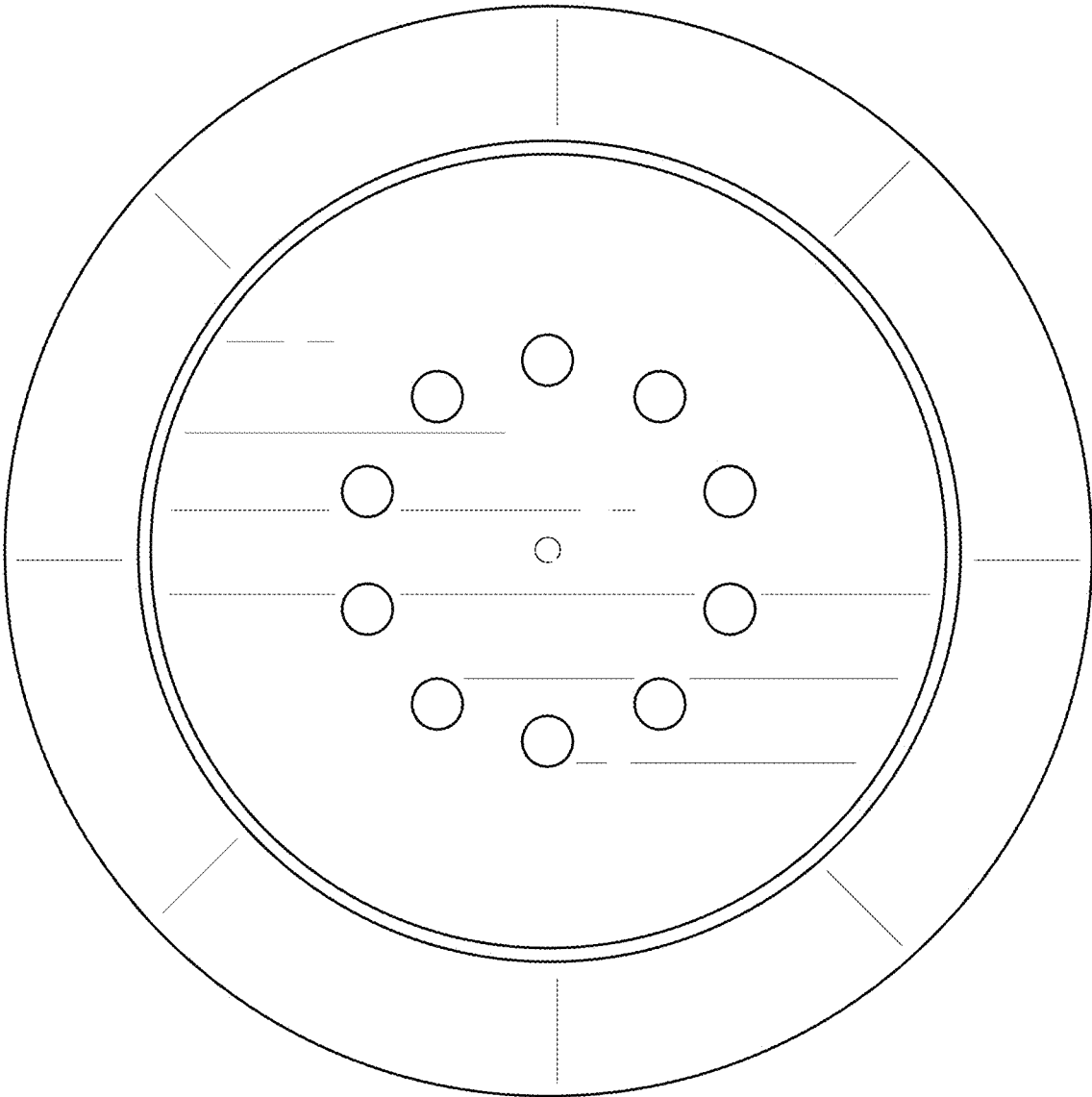

FIG. 1.2

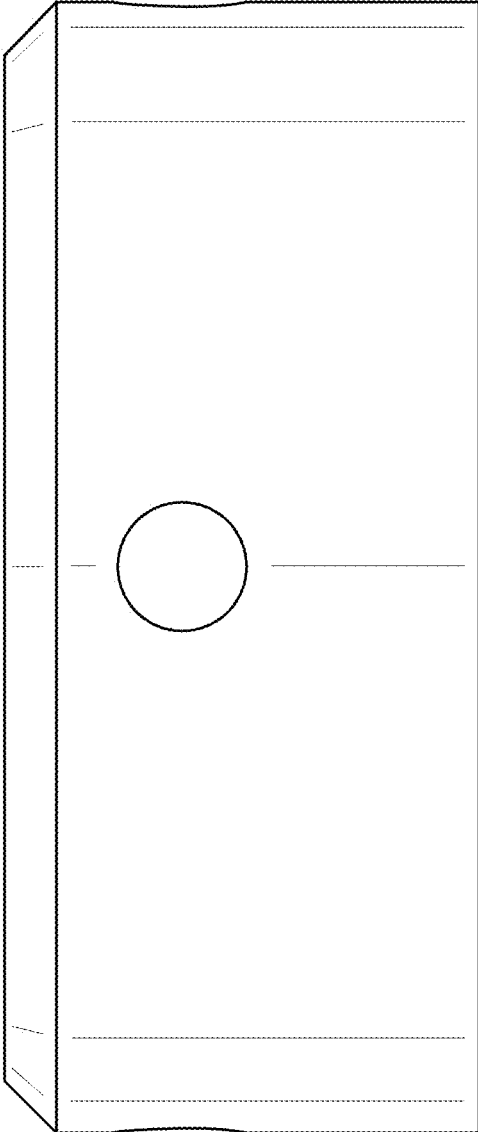

FIG. 1.3

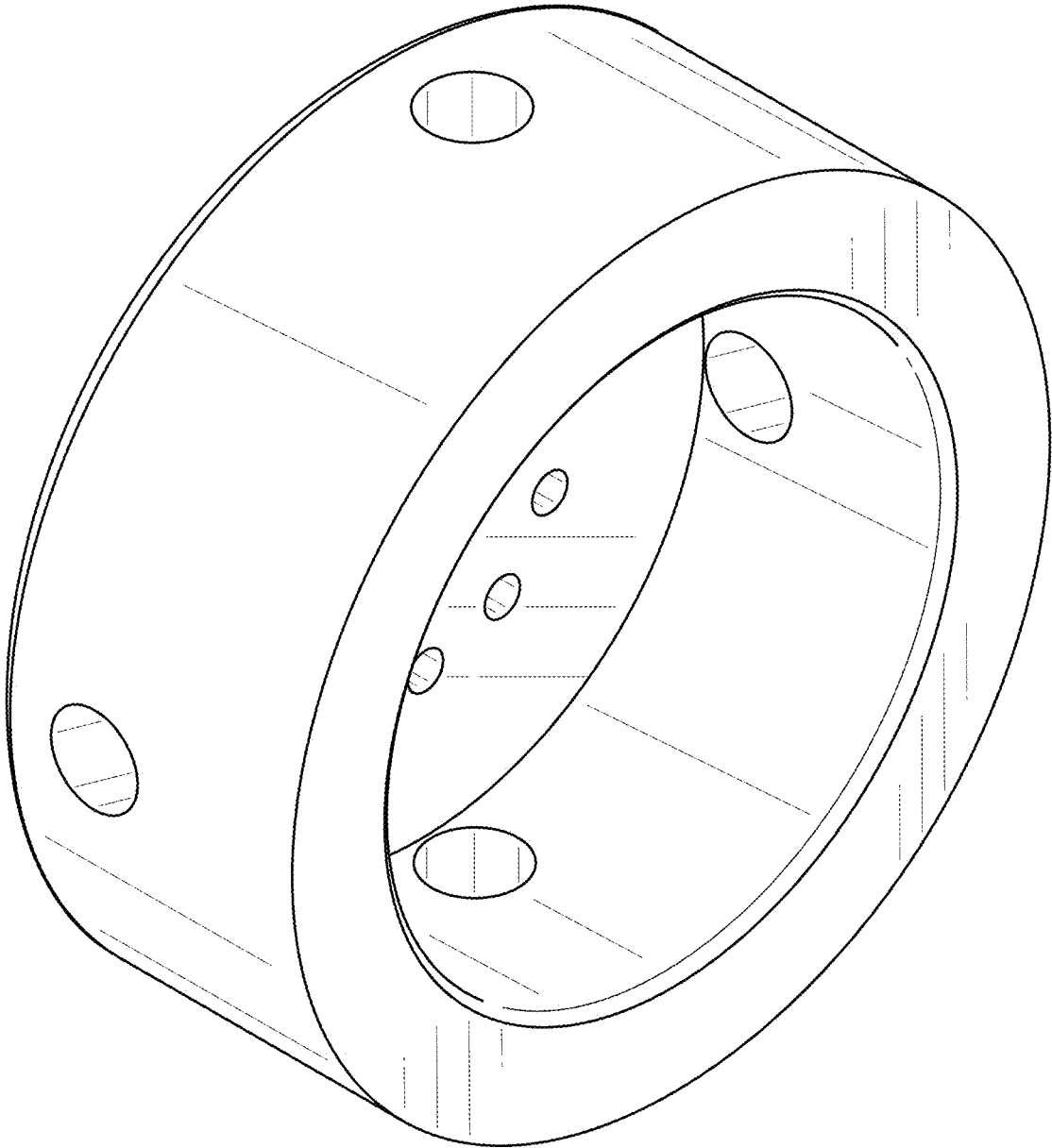

FIG. 1.4

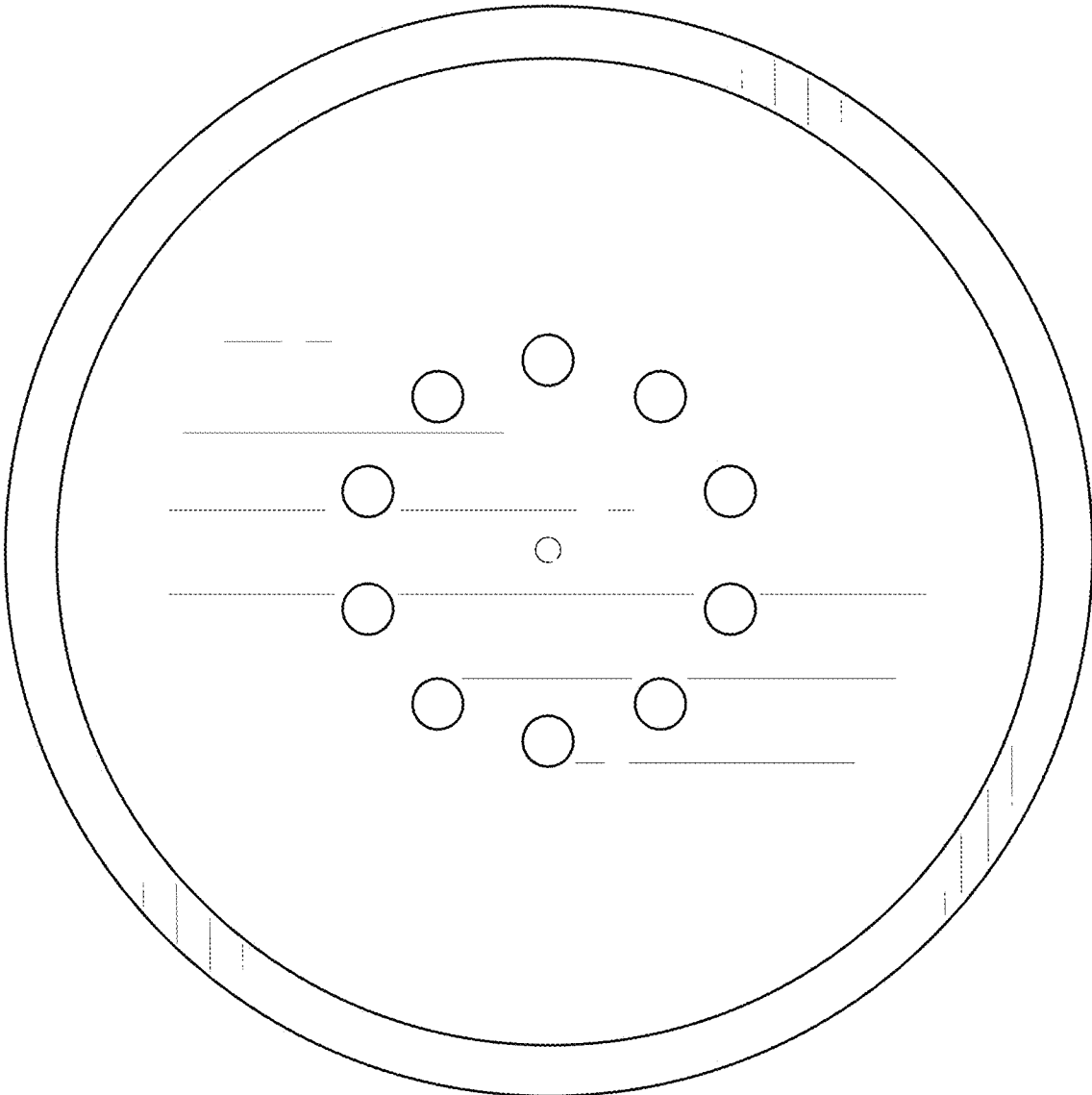

FIG. 1.5

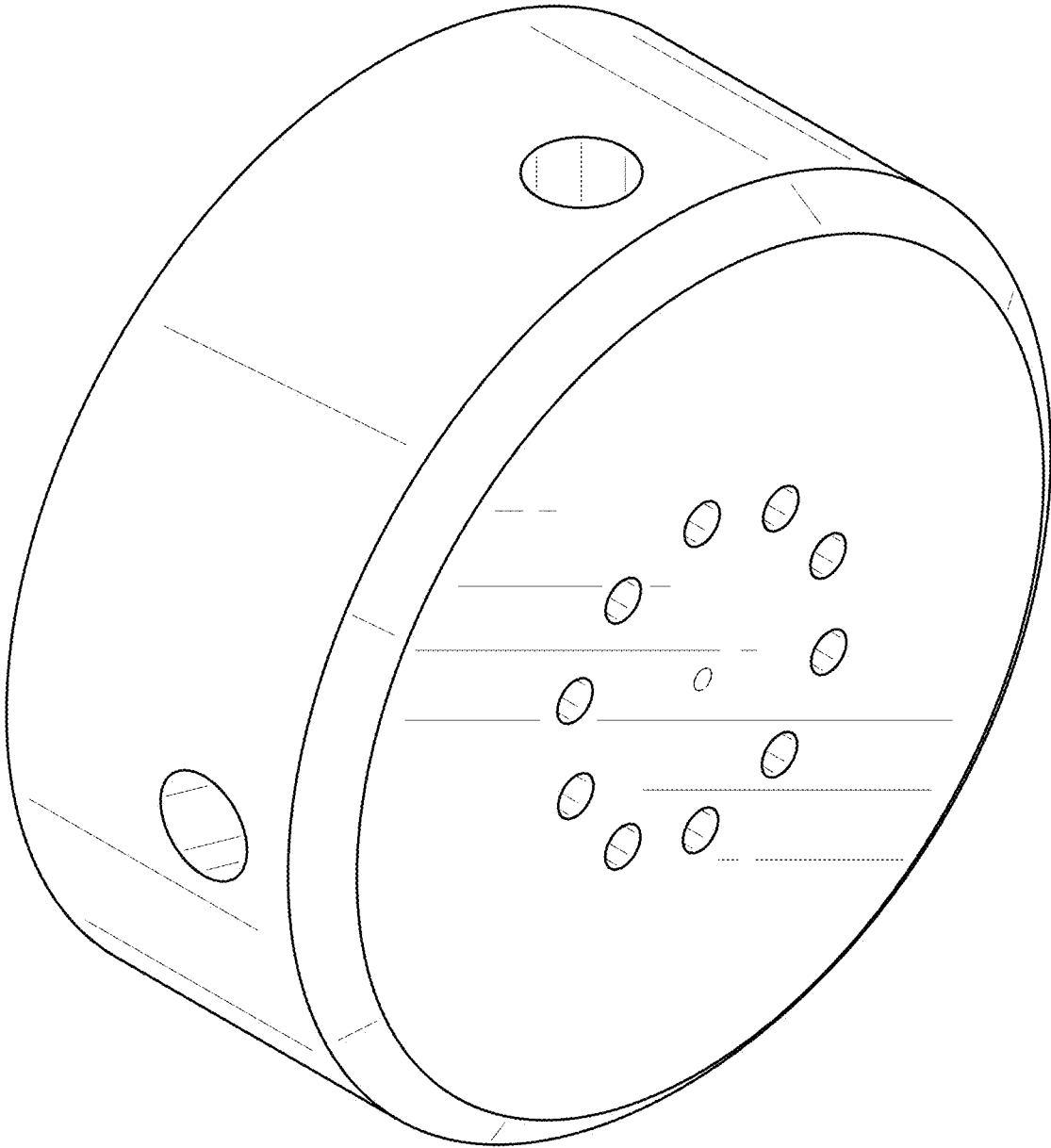

FIG. 1.6