



US0D1048874S

(12) **United States Design Patent**  
**Tian**

(10) **Patent No.:** **US D1,048,874 S**

(45) **Date of Patent:** **\*\* Oct. 29, 2024**

- (54) **DOOR BRACE**
- (71) Applicant: **Song Tian**, Bazhou Hebei (CN)
- (72) Inventor: **Song Tian**, Bazhou Hebei (CN)
- (\*\*) Term: **15 Years**
- (21) Appl. No.: **29/954,804**
- (22) Filed: **Jul. 30, 2024**
- (30) **Foreign Application Priority Data**  
Jul. 3, 2024 (CN) ..... 202430413054.5
- (51) **LOC (14) Cl.** ..... **08-09**
- (52) **U.S. Cl.**  
USPC ..... **D8/402; D8/330**
- (58) **Field of Classification Search**  
USPC ..... D8/330, 331, 339, 343, 400, 402, 499  
CPC .... E05C 19/003; E05C 19/004; E05C 19/005;  
E05C 19/006; E05C 19/18; E05C 19/184;  
E05C 19/188; Y10S 292/15; Y10T  
292/23; Y10T 292/37; Y10T 292/65;  
Y10T 292/67  
See application file for complete search history.

- 4,300,796 A \* 11/1981 Lane ..... E05C 19/004  
292/339
- 4,438,640 A \* 3/1984 Willis ..... E05C 19/004  
292/339
- 4,478,168 A \* 10/1984 Wimmer ..... E05C 19/004  
116/DIG. 44

(Continued)

**OTHER PUBLICATIONS**

“TTT Door Brace,” May 28, 2021, YouTube.com, site visited Aug. 24, 2024: [https://www.youtube.com/watch?v=\\_id1tHX0XLA](https://www.youtube.com/watch?v=_id1tHX0XLA) (Year: 2021).\*

(Continued)

*Primary Examiner* — Jack Reickel  
*Assistant Examiner* — Michael A Kervin

(57) **CLAIM**

The ornamental design for a door brace, as shown and described.

**DESCRIPTION**

FIG. 1 is a perspective view of a door brace showing the new design;  
 FIG. 2 is another perspective view thereof;  
 FIG. 3 is a front elevation view thereof;  
 FIG. 4 is a back elevation view thereof;  
 FIG. 5 is a left-side elevation view thereof;  
 FIG. 6 is a right-side elevation view thereof;  
 FIG. 7 is an enlarged top plan view thereof; and  
 FIG. 8 is an enlarged bottom plan view thereof; and,  
 FIG. 9 is an enlarged view of the encircled portion in FIG. 1.  
 The equal-length broken lines depict portions of the door brace that form no part of the claimed design.  
 The dash-dot lines in FIG. 1 and FIG. 9 illustrate the boundaries of the enlarged view indicators and form no part of the claimed design.

**1 Claim, 9 Drawing Sheets**

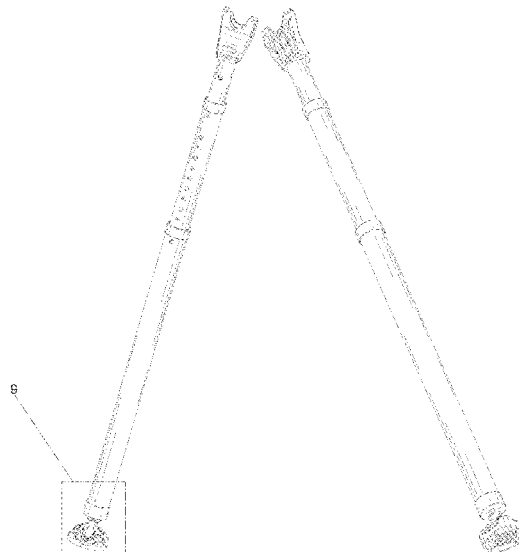

(56)

**References Cited**

U.S. PATENT DOCUMENTS

4,563,027 A \* 1/1986 Chechovsky ..... E05C 19/004  
292/339  
4,641,869 A \* 2/1987 Johnson ..... E05C 19/004  
292/339  
D290,579 S 6/1987 Crisp, Jr.  
4,676,536 A \* 6/1987 Arbic ..... E05C 19/004  
248/354.1  
4,819,296 A \* 4/1989 Wilkins ..... E05C 19/004  
16/293  
5,064,232 A \* 11/1991 Quarberg ..... E05C 19/004  
292/339  
5,333,922 A \* 8/1994 Jones ..... E05C 19/004  
292/339  
D365,019 S \* 12/1995 Rich ..... D8/402  
D375,037 S \* 10/1996 Toenders ..... D8/339  
5,951,071 A \* 9/1999 Elliott ..... E05C 19/004  
292/262  
5,988,710 A \* 11/1999 Kortschot ..... E05C 19/004  
292/339  
D431,997 S \* 10/2000 Markegard ..... D8/330  
7,030,758 B1 \* 4/2006 Markegard ..... E05C 19/004  
292/338  
D583,268 S \* 12/2008 Chan ..... D10/106.1  
D813,014 S \* 3/2018 Mattozzi ..... D8/330

2005/0225099 A1 \* 10/2005 Quarberg ..... E05C 19/004  
292/339  
2014/0353988 A1 \* 12/2014 Al Kayali ..... E05C 19/004  
292/339  
2022/0127881 A1 \* 4/2022 McCain ..... E05B 65/0888

OTHER PUBLICATIONS

“Honesaloc 2-in-1 Door Security Bar,” Sep. 15, 2021, Amazon.com, site visited Aug. 24, 2024: <https://www.amazon.com/dp/B09G9LKPS6> (Year: 2021).  
\*  
“Sliding Door Security Bar,” Nov. 1, 2022, Amazon.com, site visited Aug. 24, 2024: <https://www.amazon.com/dp/B0BTDCTXCP> (Year: 2022).  
\*  
“AceMining Upgraded Door Security Bar & Sliding Patio Bar, Heavy Duty Stoppers Adjustable Jammer for Home, Apartment, Travel (1 Pack, White)” as retrieved from the following Amazon link on Jul. 30, 2024: [https://www.amazon.com/AceMining-Upgraded-Security-Adjustable-Apartment/dp/B0BKKTFWJK/ref=sr\\_1\\_1\\_sspa?crd=XF2ZK2ZJYOVG&dib=eyJ2ljojMSJ9](https://www.amazon.com/AceMining-Upgraded-Security-Adjustable-Apartment/dp/B0BKKTFWJK/ref=sr_1_1_sspa?crd=XF2ZK2ZJYOVG&dib=eyJ2ljojMSJ9).  
\*  
“Security Door Stopper with Alarm & Sliding Patio Bar, 120db Loud Alert Adjustable Security Jammer Door Security Bar Window Child Proof Heavy Duty Door Stoppers for Home Apartment Travel—Black” as retrieved from the following Amazon link on Jul. 30, 2024: [https://www.amazon.com/Security-Stopper-Adjustable-Stoppers-Apartment/dp/B0CH9F7891/ref=sr\\_1\\_54?](https://www.amazon.com/Security-Stopper-Adjustable-Stoppers-Apartment/dp/B0CH9F7891/ref=sr_1_54?)

\* cited by examiner

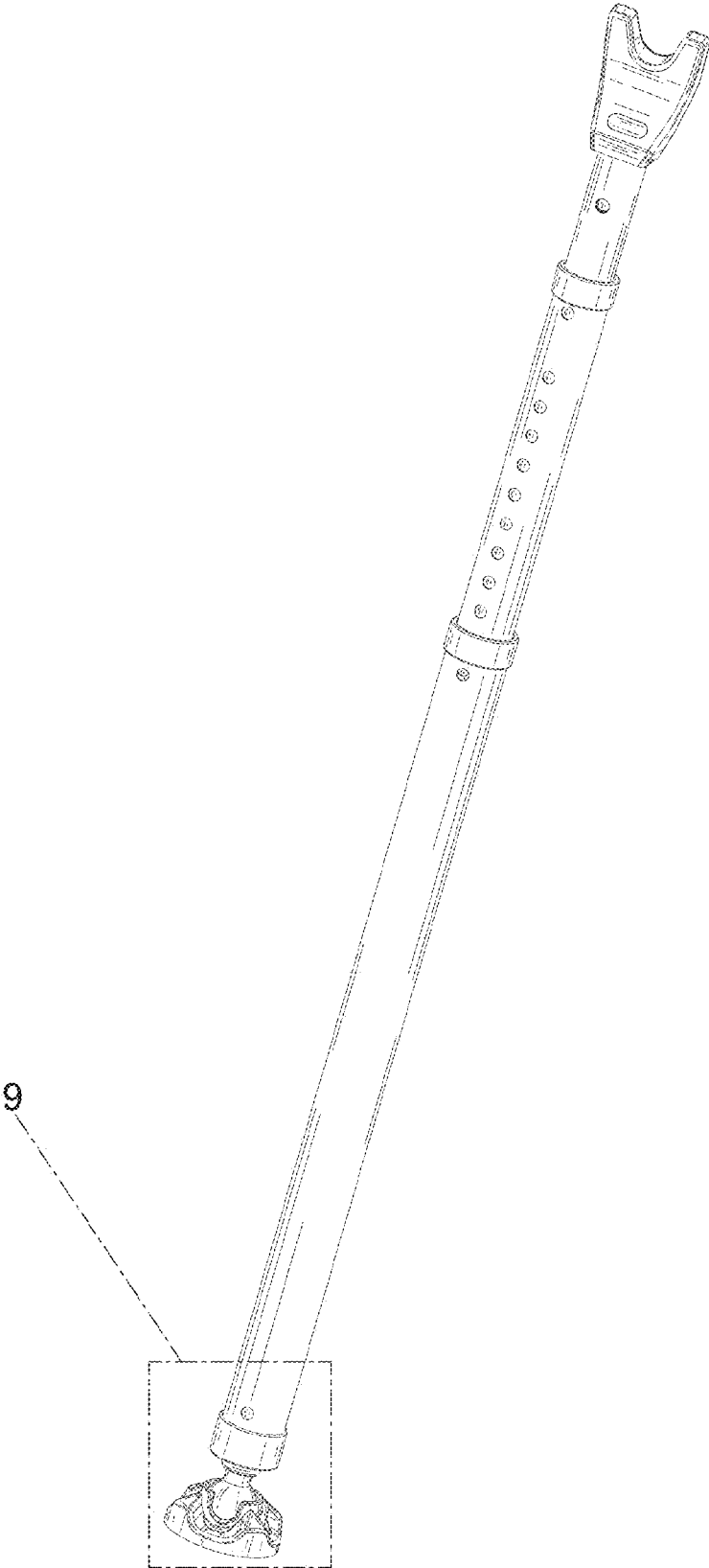

FIG. 1

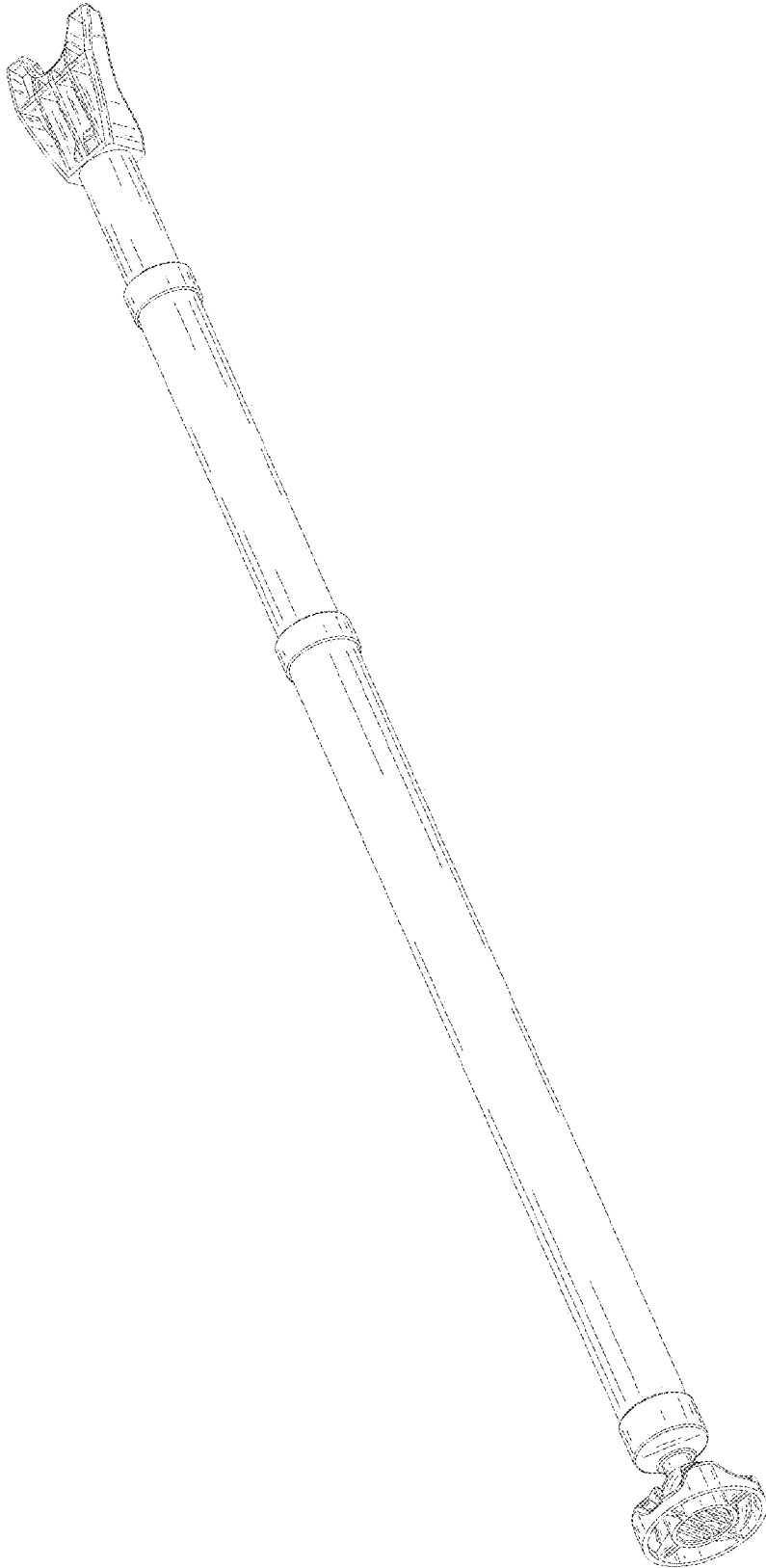

FIG. 2

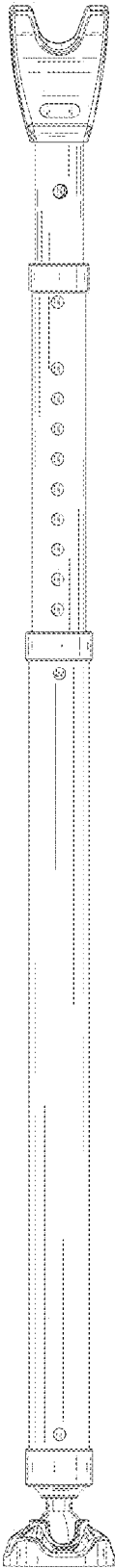

FIG. 3

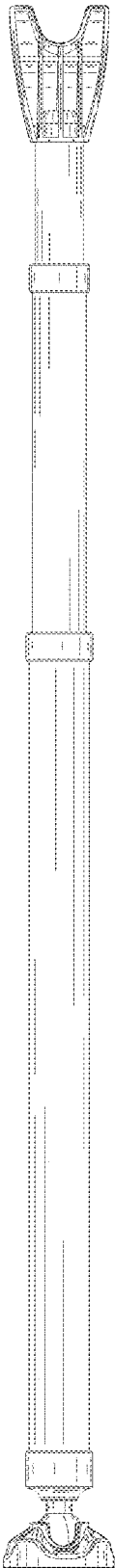

FIG. 4

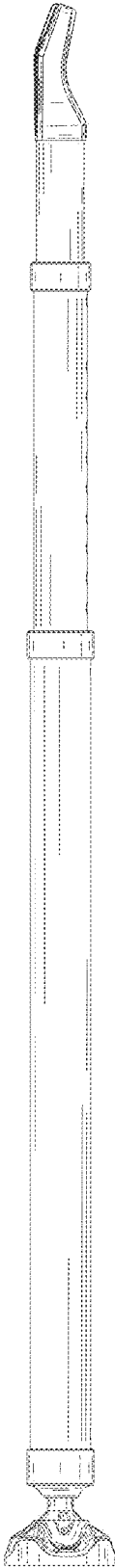

FIG. 5

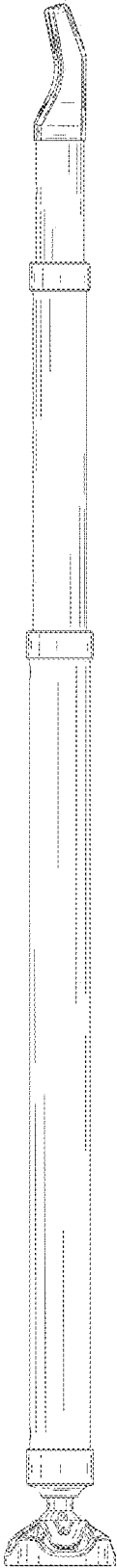

FIG. 6

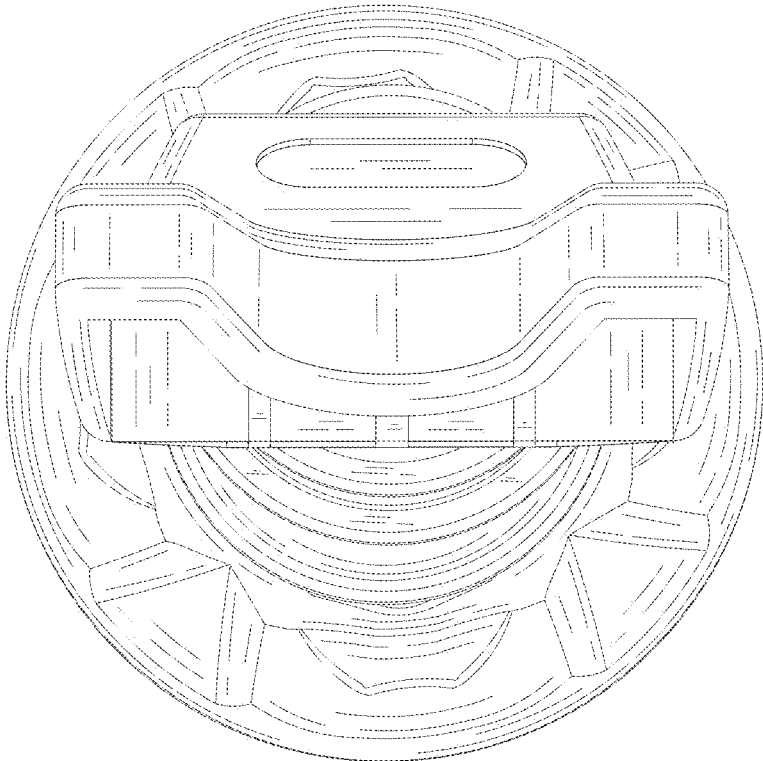

FIG. 7

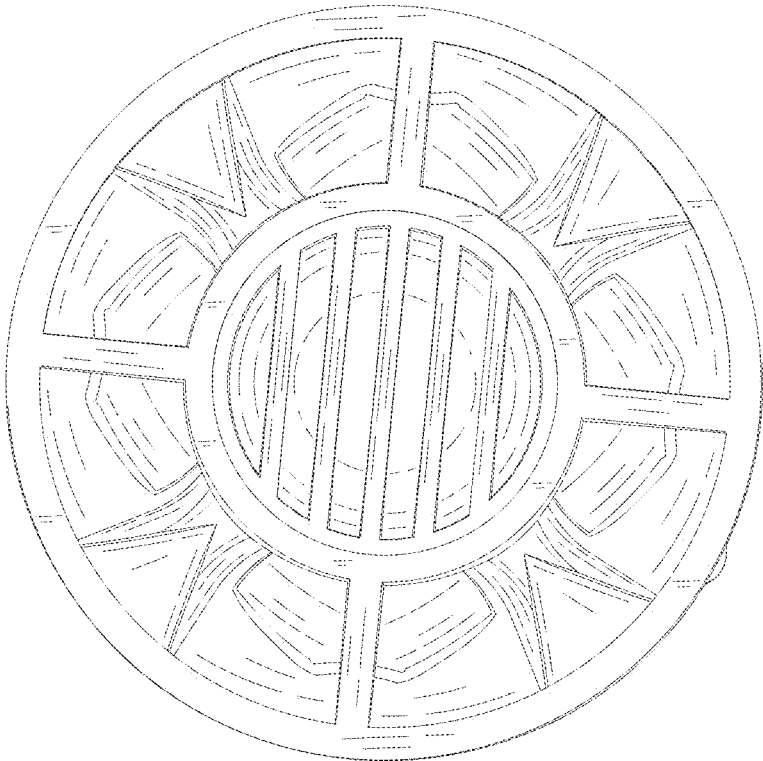

FIG. 8

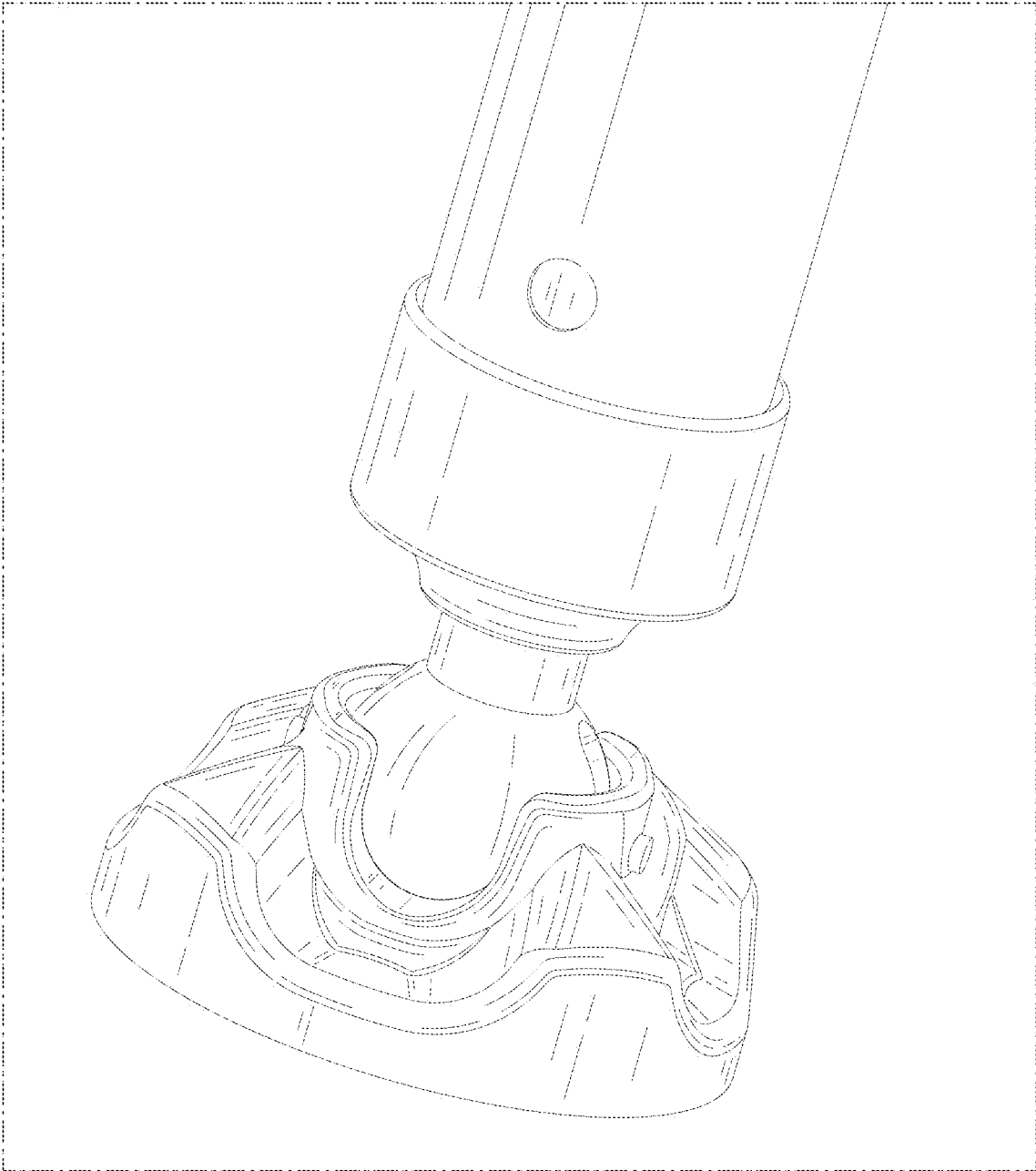

FIG. 9