

(19) World Intellectual Property Organization
International Bureau



(43) International Publication Date
15 February 2001 (15.02.2001)

PCT

(10) International Publication Number
WO 01/10518 A1

- (51) International Patent Classification⁷: A63B 71/06
- (21) International Application Number: PCT/SE00/01501
- (22) International Filing Date: 18 July 2000 (18.07.2000)
- (25) Filing Language: Swedish
- (26) Publication Language: English
- (30) Priority Data:
9902773-2 22 July 1999 (22.07.1999) SE
- (71) Applicant (for all designated States except US):
APROCH...AB [SE/SE]; Vaktgatan 10, S-262 31
Ängelholm (SE).
- (72) Inventors; and
- (75) Inventors/Applicants (for US only): LUNDGREN,
Stefan [SE/SE]; V Kyrkogatan 5, S-262 32 Ängelholm
(SE). HELMERSSON, Bengt [SE/SE]; Gästgivarevägen
12, S-266 98 Hjärnarp (SE).
- (74) Agents: ÅKERMAN, Mårten Albihns Patentbyrå
Malmö AB et al.; P.O. Box 4289, S-203 14 Malmö (SE).
- (81) Designated States (national): AE, AG, AL, AM, AT, AU,
AZ, BA, BB, BG, BR, BY, BZ, CA, CH, CN, CR, CU, CZ,
DE, DK, DM, DZ, EE, ES, FI, GB, GD, GE, GH, GM, HR,
HU, ID, IL, IN, IS, JP, KE, KG, KP, KR, KZ, LC, LK, LR,
LS, LT, LU, LV, MA, MD, MG, MK, MN, MW, MX, MZ,
NO, NZ, PL, PT, RO, RU, SD, SE, SG, SI, SK, SL, TJ, TM,
TR, TT, TZ, UA, UG, US, UZ, VN, YU, ZA, ZW.
- (84) Designated States (regional): ARIPO patent (GH, GM,
KE, LS, MW, MZ, SD, SL, SZ, TZ, UG, ZW), Eurasian
patent (AM, AZ, BY, KG, KZ, MD, RU, TJ, TM), European
patent (AT, BE, CH, CY, DE, DK, ES, FI, FR, GB, GR, IE,
IT, LU, MC, NL, PT, SE), OAPI patent (BF, BJ, CF, CG,
CI, CM, GA, GN, GW, ML, MR, NE, SN, TD, TG).
- Published:
— With international search report.

[Continued on next page]

(54) Title: SYSTEM, COMPUTER PROGRAM PRODUCT AND METHOD FOR RECORDING AND ANALYSING PERFORMANCE DATA

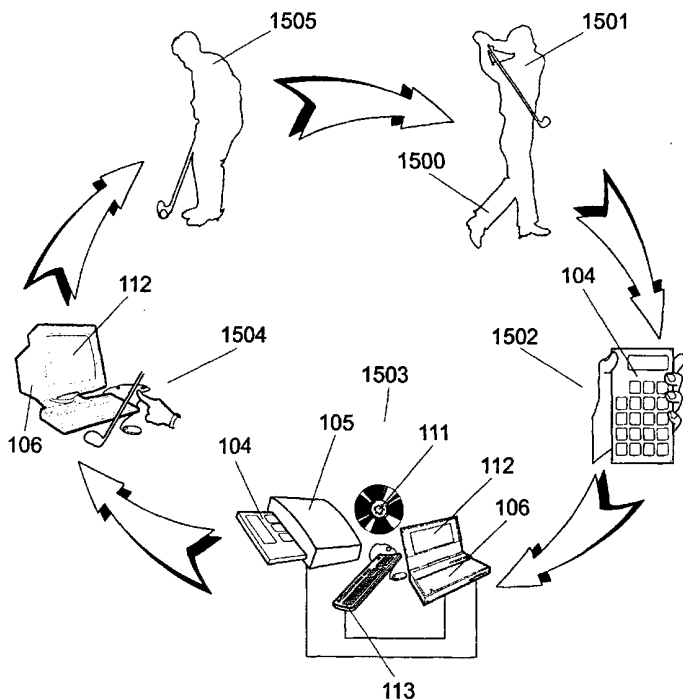

(57) Abstract: A system, a computer program product and a method for registration and analysis of data from a practised stage, and for generation of action programs in dependence of said data. Preferably, the system and the method are adapted for the analysis of the player properties of a sports practiser (1500) and for the generation of an action program in the form of a training model for the player, whereby the player will, while practising (1501) the sport, register (1502) player data (101) and result data (102) in a registration unit (104). In a parameter processing unit (106), a player characteristics profile, depending of said registered data, is generated (1503), regarding various parameters, such as shot type, number of shots per shot type, etc., as well as a comparison profile by means of which a current player characteristics profile for a player is compared with a normal profile for an average player. In dependence of the comparison profile, an action program is automatically selected and presented (1504), aiming at eliminating the deviations from the normal profile by suggesting appropriate training (1505).

WO 01/10518 A1



For two-letter codes and other abbreviations, refer to the "Guidance Notes on Codes and Abbreviations" appearing at the beginning of each regular issue of the PCT Gazette.

System, computer program product and method for recording and
Analysing performance data

TECHNICAL FIELD

5 The present invention relates to a system and a method for automatically performing an analysis of registered data, and, also automatically, generating an action program, in dependence of the registered and analysed data. For example it is directed towards registration and analysis of sports practisers' game results and player properties, and generation of action programs, comprising training models, in
10 dependence of said analysis and of game statistics regarding various game parameters. The invention is equally applicable to e.g. administrative routines for collection and processing of data, for the purpose of generating appropriate action.

STATE OF THE ART

15 Within many areas there exists a requirement for processing collected data, and for comparing it with existing statistics, with the aim of allowing a reasonable assessment of the collected data. For example in administrative or economical routines for enterprises, organisations, hospitals or authorities, registration of data from various parties is very frequent, e.g. business results, sales, staff turnover or similar.
20 Concerned parties might be countries, enterprises, branch offices, departments, persons, etc. The registered data are often difficult to evaluate alone, and some characteristics or trends may be difficult or impossible to discern without a comparison with an equivalent group or reference. This type of administrative work is often both complicated and time-consuming, even if its results may be very useful for evaluation
25 or for application of action programs for the purpose of improving various parameters.

 Another area within which a corresponding problem exists is sports. There is, within most sports, a need for registration of results in the form of number of points, e.g. in tennis, or number of shots per course section or hole, e.g. in golf. This type of
30 result registration is generally aimed at determining the winner of a competition stage. Another requirement for result registration is more directed towards analysing, based upon registered statistics, the playing properties of a player or a team, either for comparing with the properties of opponents or for supporting target-oriented training.

35 For different sports, there is today a multitude of different registration means available, ranging from paper forms to portable or stationary computer units. For golf e.g., there are portable electronic registration units for storage of the number of shots per hole, number of putts, type of club or shot length with each club. In some cases there are possibilities of transferring registered result data from a simpler

registration unit to a more sophisticated computer, e.g. a personal computer, in order to facilitate collection and printing of statistics.

The patent publication US 5,683,303, to Lambourne, discloses an electronic result registration apparatus for golf, wherein player data, such as name or initials and handicap, and result data, such as each player's number of shots per hole, putts per hole and won or lost holes per match, can be registered.

Also, the patent publication US 5,795,237, to Miyamoto, discloses an electronic apparatus for entering golf course data and result data by means of a pen and a keyboard, and for presentation of golf results. This patent document, as well as the preceding one, is mainly aimed at registration of result data.

Another piece of known art, more particularly the patent document US 5,558,333, to Kelson et al, discloses a system that is more focused on game improvement, based upon result data from real games. The system uses a microcomputer for displaying a graphical representation of a golf course, in order to register shot locations. Shot length and number of shots are registered, together with other game data, for subsequent analysis regarding possible improvements. What is presented as an analysis, however, only comprises a processing of the player's input data, e.g. a calculation and presentation of mean values. Furthermore, this system is rather complex, and time consuming for the user.

In "Golfing and your Palm Organizer" by Cox in Palm Power Magazine, December 1998, www.palmpower.com/issuesprint/issue199812/golf.html, a computer program is shown, which can be used together with a palm computer or a PC. With this computer program, player data and result data can be entered during a golf round, and statistics can be calculated and displayed.

In US 5,810,680, to Lobb et al, a portable golf registration apparatus is disclosed, comprising a GPS receiver and a geographical information system. This apparatus also has the capacity of calculating statistics in dependence of result data.

In US 5,882,269, to Lewis, a portable sports training aid means is disclosed, e.g. in the form of a PDA with associated software. On the aid means, a golfer may indicate result data, shot for shot. Statistics can be calculated and training tips can be issued in dependence of the player's result.

OBJECT OF THE INVENTION

The invention is aimed at solving the problem of providing a system for efficient characterisation of the properties of a practiser of a certain stage. One aspect of the problem is to provide, based upon the property characteristics, a basis for improving the practiser's properties. Another aspect of the problem is to provide a basis for a sports practiser to obtain a clear and reliable presentation of his/her own characteristics.

SUMMARY OF THE INVENTION

According to an overall aspect, the invention relates to a system for registration and analysis of data from a practised stage, and for generation of action programs in dependence of the performed analysis. The stage could for example be a quality revision, an economic calculation, or a game round of some sport. The system comprises an input device, in the form of a registering unit, for entering result data. The result data will of course vary depending on the embodiment, but will comprise values of one or more predetermined parameters from one or several performed stages. A calculating device is connected to the input device and arranged to calculate, for each of said parameters, a characteristics measurement value for a predetermined characteristics measurement, in dependence of said result data. These could e.g. be measurement values of statistical entities, such as mean values, median values, extreme values, etc., for said parameters. A profile generation device, connected to said calculation device, is devised to generate a characteristics profile by compiling said calculated characteristics measurement values, and the system further comprises a reference database with a pre-stored normal characteristics profile. Said characteristics profile is a profile for practisers of said stage, whereas said normal characteristics profile is a profile calculated from a group of practisers with common properties, e.g. an average, a median value or an extreme value. A comparison device, connected to the profile generation device and the reference database, is arranged to generate a comparison profile by comparing said characteristics profile with said pre-stored normal characteristics profile. The system further comprises a selection device, connected to the profile generation device, functioning to select, in dependence of said characteristics profile or comparison profile, a pre-stored action program.

According to a preferred embodiment, the invention emanates from the inventors' realisation that such game statistics that is normally kept during a game round when practising some sport, e.g. the number of shots of various types in golf or tennis, could be used for creating a characterising profile of the properties of the player. This is based upon the knowledge that the result of a game round is not coincidental, but of course dependent on the skills and shortcomings of the player. The reliability of the profile will increase through using game statistics from a number of game rounds and calculating average values for various selected parameters.

In its most general form, the invention includes a system and a method comprising registration of result data in the form of values for one or several predetermined game parameters from one or several game rounds played. In the example of golf, the game parameters are typically different shot types, such as drives, transport shots, approach shots, putts, chip shots, bunker shots or penalty shots, and the

parameter value is typically the number of shots per shot type. The registration may be made by means of electronic or mechanical means, or even with paper and pencil. For a number of selected game parameters, a characteristics measurement value is calculated for a predetermined characteristics measurement, e.g. the average number of shots per round, in total and per shot type. Subsequently, a characteristics profile for the player properties of the sports practiser is generated by compiling said calculated characteristics measurement values. This profile will thus provide a characteristic description of the playing performance of a player. For a human observer, the profile is preferably visualised graphically, e.g. in the form of a bar diagram or a curve, for example clearly presenting the average number of shots per round and the shot types. The profiles are adapted to the subject player regarding for example age, sex, playing performance, handicap, ranking or other player property.

In a further step, a comparison profile is generated for the sports practiser, by comparing said characteristics profile with a pre-stored normal profile for a normal player, having corresponding or better player data within the same age and sex group. This comparison profile will subsequently be the basis of a further step, wherein automatic selection and recommendation is performed of one or several pre-stored training models or action programs, intended to eliminate deviations in player properties, preferably player performance, from the comparison profile.

The selected parameters will of course be different for different sports, and such parameters should be selected that are appropriate for defining player quality from some aspect. For tennis e.g., the relative number of shots per shot type, the number of shots missed per shot type, ball touch-downs and ball hits, might be adequate parameters.

Various embodiments of the invention comprise a computer program product for controlling a computer to perform various portions of the method, and a system including hardware in combination with computer software.

Other characteristics and embodiments of the invention can be evident from the detailed description and the appended claims.

30

BRIEF DESCRIPTION OF THE DRAWINGS

The invention will now be explained in further detail, with reference to the enclosed drawings, of which:

Fig. 1 shows an overall block diagram of an embodiment of the system according to the invention;

Fig. 2 shows a flow chart of the steps according to an embodiment of the invention;

Fig. 3 shows an overall block diagram of devices comprised in embodiments of the invention;

- Figs. 4-7 show examples of characteristics profiles for golf players, in the form of bar diagrams;
- Fig. 8 shows an example of a comparison profile, more precisely a difference profile, for a golf player;
- Fig. 9 shows an example of a characteristics profile for a golf player in the form of a curve chart;
- Figs. 10-12 show examples of characteristics profiles and comparison profiles for tennis players;
- Fig. 13 shows an example of a presentation of input and processed directional data and distance data for a golf player;
- Fig. 14 shows an example of a comparison profile, wherein a characteristics profile for a golf player as well as a reference profile for a normal player are provided as separate curves in a curve chart; and
- Fig. 15 shows a schematic illustration of one embodiment of the method according to the invention, for the example of golf.

DETAILED DESCRIPTION OF PREFERRED EMBODIMENTS

The present invention is, as was stated before, applicable to a multitude of different areas. In order to describe the invention as clearly as possible, substantially only sports embodiments will be discussed below, preferably the example of golf. This should not, however, be interpreted as if other embodiments were excluded from the scope of the invention. The described embodiments should rather be regarded solely as examples, and in order to call the reader's attention to one of the numerous other conceivable embodiments, a description of one embodiment of the invention within the area of revision in the health care sector is given further down in this description.

Fig. 1 shows an embodiment of the system according to the invention, comprising an electronic registration unit 104 for entering player data 101 and result data 102. As can be gathered from the figure, said data are entered via a keyboard 107 with keys 114 allowing input of various types of information. In its simplest form, the registration unit will only store stated data in various categories and the registering unit would be paper and pencil. The registration unit 104 further comprises a simple display 115, for presentation of input and processed data to the user. The system further includes a parameter processing unit 106 that, in various embodiments, can be partly or fully integrated in the electronic registration unit. In any occasion the parameter processing unit includes an input device 105 for receipt of result data and possibly player data. This could for example be performed by connecting a data output 103 of the registration unit to the input device 105. The parameter processing unit further includes data processing means in the form of a

processing unit (CPU) 108 and a memory 109, and comprises, or is connected to, a database 110 containing pre-stored normal profiles. A presentation unit 112, in the form of a display or a printer, is also connected to the parameter processing unit, as is preferably a control and data input device 113 in the form of a keyboard, a mouse, or similar. In a preferred embodiment, the invention is realised in the form of a computer program product comprising a computer program, stored on a data storage medium 111 and functioning to control a data processing system, e.g. a personal computer, to perform the steps according to the invention. The parameter processing unit is then normally realised by means of a known PC and arranged according to the invention by means of the computer program product.

Fig. 2 shows an overall flow chart of the method according to the invention. After Start 202, the following step numbers comprise:

- 204, registering result data, in the form of values for one or more predetermined game parameters, from one or several completed game rounds;
- 206, calculating, for every stated game parameter, a characteristics measurement value for a predetermined characteristics measurement;
- 208, generating a characteristics profile for the player properties of the sports practiser through compiling said calculated characteristics measurement values;
- 210, presenting, if requested, a graphic representation of the generated characteristics profile;
- 212, retrieving, from a database, a normal profile;
- 214, generating a comparison profile for the sports practiser by comparing said characteristics profile with a normal profile for a normal player, which normal profile is pre-stored in said database. In one embodiment, this step comprises the measure of applying a predetermined mathematical operation to the characteristics profile and the normal profile. The comparison profile can be realised in the form of a difference profile, generated by calculating the difference between the characteristics measurement values for each game parameter of the characteristics profile and the normal profile. In another embodiment, a comparison profile for the sports practiser is generated by compiling, for each game parameter, a current characteristics measurement value for the sports practiser, a stored best characteristics measurement value value for the sports practiser, and a normal characteristics measurement value for a normal player;
- 216, presenting, if requested, a graphic representation of the generated comparison profile;
- 220, selecting, in dependence of said characteristics profile or comparison profile, one or several pre-stored action programs, retrieved or fetched in step 218 from a database of pre-stored action programs, preferably in the form of training models;
- 222, presenting the selected action program to the user;

-224, stopping and, if requested, repeating selected ones of the previous steps.

In one embodiment, player data for the sports practiser are registered, whereby said normal profile is based upon corresponding player data, for example, age group, sex, handicap or ranking. As mentioned above, the characteristics profile or comparison profile may be presented visually in the form of a bar diagram having one bar for each game parameter, where the bar height corresponds to the characteristics measurement value, or in the form of a corresponding curve chart.

In the embodiment from which the exemplifying profiles in Figs. 4-9 are collected, the invention is adapted for the analysis of a golfer's playing properties, the game parameters being various shot types and the characteristics measurement being the number of shots on average, per round. In another embodiment, from which the exemplifying profiles in Figs. 10-12 are collected, the invention is adapted for the analysis of a tennis player's playing properties, the game parameters being various shot types and the characteristics measurement being the percentage distribution of successful shots in relation to unsuccessful ones.

Fig. 3 shows a block diagram for an apparatus or a computer program product according to the invention. In the apparatus embodiment, the devices will normally be realised by means of hardware components, possibly in combination with associated software. In the computer program product, the corresponding means will normally be realised through program instruction sequences stored on a storage medium and arranged for controlling a computer processing system into performing the actions according to the invention. The lines between the blocks of the block diagram indicate signal connections or communicative connections for signal or data communication between the devices.

The embodiment according to Fig. 3 comprises input device 302, for input and/or receipt of result data and player data, and a device 303 in the form of a data structure for storing said data in a memory. Further, a calculating device 304, for calculation of characteristics measurement values, and a device 306 in the form of a data structure for storing said characteristics measurement values in a memory, are included. The computing device 304 is devised to operate in dependence of said result data and/or player data from the input device 302 or the memory device 303. A device 308 for generation of a characteristics profile is devised to operate in dependence of the characteristics measurement values from the calculating device 304 or the memory device 306, and is in turn devised to store generated characteristics profiles into a device 310, in the form of a data structure for storing such characteristics profiles in a memory. Data structures for normal profiles, also called reference profiles, are pre-stored in a reference database 311. Further, a device 312, for generation of a comparison profile, receives a characteristics profile as input data from the memory 310 and a normal profile as input data from the reference

database 311, and can in turn store a comparison profile into a memory device, e.g. 310. In dependence of the comparison profile, a device 314 then functions to select an action program among pre-stored action programs in an action database 316, preferably a training model database. Further to this, a device 318 for presentation of characteristics profiles and comparison profiles, and a device 320 for presentation of action programs, are included. The functionally described devices are, in various embodiments, adapted to the different functions described in other sections of this description of the invention.

Examples of graphic presentations, in the form of diagrams of characteristics profiles for a golf player, are shown in Figs. 4-9 and 14, wherein the horizontal axis 402, 502, 602, 702, 802, 902, 1402, denotes game parameters such as shot type, and the vertical axis 404, 504, 604, 704, 804, 904, 1404, denotes the number of shots for a round, or preferably on average per round, on a certain golf course. The game parameters in these examples are the following different shot types:

- Drive, 406, 506, 606, 706, 806, 906, 1406, consisting of a first shot, not intended to reach the golf green with its golf hole;
- Transport, 408, 508, 608, 708, 808, 908, 1408, is the denomination for a shot type that is a continuation of an earlier shot and that is not intended to reach the green;
- Approach, 409, 509, 609, 709, 809, 909, 1409, is a shot type with the intention of reaching the green, and which is not played from a bunker;
- Putt, 410, 510, 610, 710, 810, 910, 1410, is a shot type used for the final shots, closest to the hole, generally on the green;
- Bunker, 412, 512, 612, 712, 812, 912, 1412, is a shot type being shot from a gravel or sand obstacle on the course;
- Penalty, 414, 514, 614, 714, 814, 914, 1414, is not a physical shot, but denotes how many extra penalty shots you have received due to your game on the course according to the present game rules.

Figs. 4 and 5 illustrate the current profile for an analysed player. In Fig. 5, the types of shot are also stated; the number of chip shots 516, i.e. a short shot with an iron club from a location close to the green, pitches 518, meaning a short, high shot with a highly angled club, and further two software-created shot types. The first of the latter two shows the number of shots caused by 3 or more putts on the same golf hole. The last shot type shows the number of successful bunker shots, on average, per round. A successful bunker shot may for example be defined by maximum one putt having been needed after the bunker shot.

Fig. 6 again shows the current profile for an analysed player, and Fig. 7 shows a normal profile in the form of the profile for an average player, of the same sex and handicap level. From the reference database 311, several different normal profiles can of course be retrieved, compare step 212. Sex, age, handicap level, etc. may be

selected, allowing a player to compare his own profile, i.e. playing characteristics, with a normal profile for a somewhat lower handicap. This will give the player an indication about what he/she ought to improve in order to reach a lower handicap, that is, become a better player.

5 Fig. 8 shows a comparison profile, in the form of a difference profile, as a bar diagram where the average number of shots per round from the profile of Fig. 6 has been reduced by the corresponding characteristics measurement values from the normal profile of Fig. 7. The illustrated difference profile of Fig. 8 shows the highest value for the transport shot type, and the next highest one for the approach shot type,
10 allowing the conclusion that it would be appropriate to select one or more action programs, i.e. training models, where these shot types are exercised.

Fig. 9 shows the same diagram as Fig. 6, but in the form of a curve. Another way of presenting a comparison profile, in accordance with Fig. 14, is to show the characteristics of the current player as well as that of the normal player, accessed
15 from the reference database 311. Preferably, the bars, or the curves, as illustrated in the figure, are shown with different line types or colours, so as to make them easy to separate. The characteristics profile for the various cases may of course be represented in various diagram forms, depending on which will give the most suitable visualisation.

20 The graphical presentation, according to the present invention, of the player characteristics together with, or weighted against, a normal profile, allows a very clear and simple picture of which parts of the game are in need of improvement. The normal profile, or the reference profile, takes into consideration the number of holes with par 3, par 4 and par 5 on the present course that have been played, when calculating the player profile, thus ensuring the relevance of the given normal profile at all
25 times.

The foregoing, i.e. input and calculation of player data, score, shot types, etc., and mathematical comparison between player profile and normal profile, could be called the analysis part of the system, and provides a most useful tool for the player
30 in the ambition to improve his or her game. According to the invention, the system further comprises a training part, wherein input and analysed data are used for actively proposing an action program, e.g. in the form of training models for the player.

In a preferred embodiment of the invention, the practiser/player, or anyone
35 else, for that matter, may proceed from the analysis part of the system to the training part in the parameter processing unit 106, by for example depressing a key on a keyboard 113, by a menu selection or by activating an icon on the presentation unit 112.

In the training part, advice is given on recommended training, depending on the player and reference profiles, i.e. the comparison profile. In a preferred embodiment of the invention, one or more exercise suggestions are provided, for a predetermined maximum number, e.g. 5, of shot types, said exercise suggestions being accessible by depressing a key, a menu selection or an icon activation. The exercises stored in the training database 316 are composed by golf pros, warranting a high and reliable quality. One or more training models with instructions and figures may thus be provided for a given comparison profile, and these training models may also be combined to provide a more complete training within an area where insufficiencies have been detected.

The parameters, in dependence of which exercises are suggested by the training part of the system, are e.g. sex, HCP (handicap) and area, i.e. course, range, etc. Preferably all, or the major portion of, this information will be retrieved from the analysis part of the system, but this information could also be entered directly to the training part via a keyboard 113 or similar.

For every suggested exercise, a written instruction is shown on the presentation unit 112, or on a printout if requested, and preferably one or more figures in order to make the instruction as clear as possible. Besides this, every suggested exercise is accompanied by a comment about the player types, areas, HCP levels etc., which the exercise is suitable for.

In one embodiment of the invention, the analysis part of the system, and/or its training part, are accessible from an Internet portal, belonging to a service provider. Access to the portal may for example be controlled by subscription, in combination with a user name and a password, in the known manner. In a preferred embodiment, the players can also e-mail their registered game results, together with current player data, to the service provider administrating the Internet portal and the reference database 311. The service provider may then store the player data in the reference database 311, accessible via the portal, thereby increasing the statistical accuracy and the multitude of player types of the reference database.

In one embodiment of the present invention, the registration unit 104 may also be used for registration of the length and direction of golf shots. In a preferred embodiment, this is possible by means of the numerical keys 114 indicating the digits 1 - 9 on the keyboard 107, as shown in Fig. 1. The digit 5 is used for indicating a correct shot, i.e. a shot or a putt landing where intended, within some tolerance that may be subjective. The digit 8 will mean a straight but too long shot, while the digit 2 will mean a straight but too short shot. Similarly, the digits 4 and 6 will indicate shots of correct length, but 4 will indicate a leftward deviation and 6 will indicate a rightward deviation. Consequently, the digits 1, 3, 7 and 9 will indicate shots that are too short or too long, as well as having a leftward or rightward deviation,

respectively. Preferably, the input of directional information on the registration unit 104 will be preceded by the depression of a key for that purpose on the keyboard 107, preparing the registration unit for the input of directional data.

Fig. 13 illustrates an example, according to one embodiment of the invention, of how input and processed length and direction data could be presented in the system. Assessment of the direction and length can be performed for all types of shots, and will preferably be presented for one shot type at a time. In Fig. 13, each sector represents an input with the above-mentioned keys 1 - 9. The outer ring 1301 represents 100 % of the shots within the sector in question, whereas the dashed line 1302 represents 50 %. In the inner circle 1303 is indicated, preferably by percentage figures, how large a portion of the illustrated shot type that was correct. From the figure it can be gathered that the player considered 25 % of his shots, of the shot type in question, to be correct. It should be noted that this might be the case for putts, even if one has not made just one putt to reach the hole. A putt stopping e.g. within half a metre from the hole could be considered as correct, if it was shot from maybe 5 metres or more. Furthermore, it may be gathered from Fig. 13 that the player has shot 50 % of the shots straight but too short, indicated by the sector 1304 being filled up to the dashed line 1302. The remaining 25 % of the shots have been too long and deviating towards the left, indicated by the sector 1305 being filled halfway to the line 1302. When selecting, from this analysis part presentation, to enter into the training part, the system will automatically give exercise suggestions for trying to overcome the registered problems. It will be understood that the presentation of direction data could also be performed by normal display of figures and text en clair.

Fig. 15 shows, schematically, the procedure for a preferred embodiment of the invention. A player 1500 plays, in step 1501, one or more golf rounds, whilst simultaneously registering his score in the registration unit 104, in step 1502. Into the unit 104, the player has also entered player data, such as sex, and number of extra shots given to him/her on the current course. The player 1500 will register the shot type for each shot and, in one embodiment, also if the player is satisfied or unsatisfied with the shot. The direction may also be registered, in the manner discussed above.

After finishing one round, or several rounds, the registered result data, together with the player data, are transferred to a computer 106, e.g. a PC, via an input device 105, or alternatively, the registered result data, together with the player data, are transferred directly to the Internet portal of the service provider via the input device 105. As mentioned above, the parameter processing unit may be functionally divided between the registering unit 104 and the computer 106. Thus, certain processing can be performed already in the registration unit 104, e.g. calculation of net score, allowing the registering unit to be used also as a traditional score card.

A keyboard and/or a mouse 113 are preferably connected to the computer 106. The data input device 105 is, in a preferred embodiment, an electronic pocket with a reader, in which pocket the registration unit 104 is placed, whereupon the information stored in the registration unit 104 is read, automatically or user-initiated, and stored in the computer 106. The reading may of course, in alternative embodiments, take place by wireless transmission, using IR, Bluetooth or similar.

On a storage medium 111, e.g. a CD-ROM or a server adapted for generating a portal, software is stored for actuating said computer 106 into performing the method according to the invention within the analysis and training parts of the system. The database 311 with reference profiles, and the database 316 with training models, may also be stored on said storage medium 111, or may be accessible via a computer network, e.g. the Internet, from another storage location.

In the computer 106, the previously described analysis part can be performed and presented to the player on the display 112 or as a print-out. By means of the keyboard/mouse 113, the player may subsequently select to enter the training part 1504, whereby relevant exercises will be presented on the display 112. By studying the instructions and the figures being presented for each exercise step in the training part, the player may perform appropriate training in step 1505, whereupon he/she can come better prepared for the next round, or number of rounds, 1501. The system according to the present invention thus provides sports practisers with a heretofore not presented procedure for analysis and a training aid, in order to improve their game.

The Figs. 10 - 12 show examples of characteristics profiles generated by an embodiment of the invention adapted for tennis. Fig. 10 shows how various shot types, such as forehand 1006, backhand 1008, first service 1010 and second service 1012, respectively, defined on the horizontal axis, are distributed percentage-wise with regard to successful shots in relation to unsuccessful shots for a current period. In the profile, a current result (bar marked 1) is compared with e.g. the player's own best score (bar marked 2) and that of an average player (bar marked 3) of for example the same sex, age group or ranking level.

In Fig. 11, the forehand shot of the player in question is characterised in the same manner, during the current match or period, concerning the percentage of winning shots (bar marked 1), missed shots (bar marked 2) and shots into the court (bar marked 3). In the diagram, these are also compared with those of an average player of the same sex, and possibly age group and e.g. ranking level, and in Fig. 12 the attack game of a tennis player is characterised in the same manner. The attack shot types illustrated are; after bouncing in the court, first volley, second volley and smash.

In an example of an embodiment not concerning sports, the invention could be applied to the stage of auditing journal writing within the health care sector. A person performing the audit, in this description called a quality auditor, will follow a nurse in his/her work regarding handling of patient's journals. The quality auditor carries a registration unit, preferably an electronic box, on which the auditor enters result data for given parameters, e.g. in the form of values entered by the numerical keyboard of the box, or in the form of Yes and No as answers to predetermined check points, which could be stated as questions on the inside of the casing of the box. Examples of questions might be:

- 10 - Are the points in time stated in the journal readable?
- Is the identity of the patient checked?
- Does the nurse sign the journal?

After finishing the audit, the registered data are transferred to a PC, where a summary and statistics computation, in dependence of the result data, are performed by a profile generation device, whereupon the statistics is presented in the form of figures or diagrams. A comparison device in the PC then functions to compare the calculated statistics with a normal profile given in advance, e.g. an average taken from several different hospitals, or an average or a tendency curve for the current hospital based on previous journal audits.

20 The result of the analysis, i.e. the comparison with the normal profile, is subsequently used by a program in the computer, for selecting, among a multitude of pre-stored action programs for journal audits, an action program adapted for overcoming shortcomings detected by the performed comparison.

In a preferred embodiment within the area of journal audits, all audit results are stored on an Internet portal, where authorisation for access to the results is granted by certain responsible persons. For example, a national unit may have access to all the audits, whereas a department will only have access to their own audit results. A hospital manager has access to all the audits made in his hospital. In an alternative embodiment, the audit results can be stored in the hospital's central computer, and be transferred to other hospitals, authorities, etc., from there.

35 In one embodiment of the invention, which might be applied to both sports, administrative routines, education, etc., the action program comprises a test that is adapted to the detected shortcomings from the analysis part, e.g. a test of the kind where questions are to be answered verbally or in writing, or with multiple choice alternatives. The test is preferably executed on the practiser's computer 106 and is shown in the display 112 or played through a loudspeaker. The test may also be executed in a server arranged in a communication system, e.g. the Internet, to which the computer 106 may be connected. The test is then preferably accessible from the computer 106 via an Internet portal. Preferably, the computer/server software

corrects the test, and the result is presented to the player on the display 112. The test result may also be presented as a player profile, which is weighted or presented together with a normal profile. The normal profile may represent a statistical entity within a given group, e.g. a school class, and may be an average, a minimum value or similar. In one embodiment of the invention, the step to be practised is represented by a theoretical test within a given subject. For each question or subject area, which are parameters, the practiser's reply is registered as result data in an input device 104, 105, 302. A calculation device 106, 304 is coupled to the input device and functioning to calculate, for each of said parameters, a characteristics measurement value for a predetermined characteristics measurement, in dependence of said result data. Such characteristics measurements could be the number of correct answers within a subject area, the percentage of completely correctly answered questions within the test, or similar. A profile generation device 106, 308, connected to said calculation device functions to generate a characteristics profile by compiling said calculated characteristics measurement values. A comparison device 312, connected to the profile generation device, is functioning to generate a comparison profile through comparing said characteristics profile with a pre-stored normal profile obtained from a reference database 311. The normal profile may be an average from a given group, e.g. a class, or be compiled data for the practiser obtained from previous tests, or similar. Preferably, a selection device 314 is connected to the profile generation device 308 and/or the comparison device 312 and/or a memory storage containing a profile data structure 310, and is devised to, in dependence of said characteristics profile or comparison profile, select a pre-stored action program for the practiser. The action program preferably consists of a series of exercises adapted to overcome the shortcomings detected by said comparison, and these exercises may be practical as well as theoretical.

It is to be understood that the described areas for the exemplifying embodiments, and for the different sports, are merely examples, and that a similar type of game parameters could be defined for other areas and other sports, such as darts, billiards and many others, and characteristics profiles be created, by application of the invention.

CLAIMS

1. A system for registration and analysis of data from a practised stage, and for
5 generation of action programs in dependence of the performed analysis,
characterised by:
- an input device (104, 105, 302), for entering result data for one or more predeter-
mined parameters from one or several performed stages;
 - a calculating device (106, 304), connected to the input device and devised to
10 calculate, for each of said parameters, a characteristics measurement value for a pre-
determined characteristics measurement, in dependence of said result data;
 - a profile generation device (106, 308), connected to said calculation device, and
devised to generate a characteristics profile by compiling said calculated char-
acteristics measurement values;
 - 15 - a reference database (311) containing a pre-stored normal characteristics profile;
 - a comparison device (312), connected to the profile generation device and the ref-
erence database, and devised to generate a comparison profile by comparing said
characteristics profile with said pre-stored normal characteristics profile.
- 20 2. The system according to claim 1, wherein a device (318) for presentation of
the comparison profile is devised to present the comparison profile graphically on a
presentation unit (112).
3. A system according to claims 1 or 2, wherein the comparison device is
25 devised to generate a comparison profile by applying a predetermined mathematical
operation to the characteristics profile and the normal profile.
4. The system according to claim 3, wherein the comparison device is devised to
30 generate a comparison profile in the form of a difference profile (804), by cal-
culating the difference between characteristics measurement values for each para-
meter (806, 808, 809, 810, 812, 814) of the characteristics profile and the normal
profile.
5. The system according to claim 2, wherein said device (318) for presentation
35 of the comparison profile is devised to visualise, for each parameter (1406, 1408,
1409, 1410, 1412, 1414), a current characteristics measurement value (1415) and a
normal characteristics measurement value (1416) in the same diagram.

6. The system according to claim 1, further comprising a selection device (314) connected to the profile generation device (308) and/or the comparison device (312) and/or a memory containing a profile data structure (310), and being devised to select, in dependence of said characteristics profile or comparison profile, a pre-
5 stored action program.
7. The system according to claim 1, wherein said characteristics profile is a profile for a practiser of said stage, whereas said normal characteristics profile is a profile calculated from a group of practisers with common properties.
- 10 8. The system according to claim 7, wherein said normal characteristics profile is a profile for an average practiser within said group.
9. A system according to claims 7 or 8, wherein said practiser is a sports practiser, said stage being a game round of said sport, said parameter is a game
15 parameter and said action program is a training model for improvement of the practiser's player properties within said sport.
10. The system according to claim 9, further comprising a device (302) arranged
20 for entering player data for the sports practiser, and wherein said normal profile is based upon corresponding player data, for example age group, sex, handicap or ranking.
11. The system according to claim 10, wherein said device (318) for presentation
25 of the comparison profile further is devised to visually present, on said presentation unit (112), the characteristics profile or the comparison profile in the form of a bar diagram (404, 504, 604, 704, 804, 1004, 1104, 1204) having one bar for each game parameter, where the bar height corresponds to the characteristics measurement value.
- 30 12. The system according to claim 10, wherein said device (318) for presentation of the comparison profile further is devised to visually present, on said presentation unit (112), the characteristics profile or the comparison profile in the form of a curve
35 chart (904, 1404), where the level of the curve for each game parameter corresponds to the characteristics measurement value.
13. The system according to claim 10, adapted for the analysis of the player properties of a golfer, whereby the game parameters are various shot types and the characteristics measurement is the average number of shots per round.

14. The system according to claim 10, adapted for the analysis of the player properties of a tennis player, whereby the game parameters are various shot types and the characteristics measurement is the percentage distribution of successful shots in relation to unsuccessful ones.
15. The system according to claim 10, further comprising a device (314) for maintaining a computer structure for storing of characteristics measurement values in a memory (110).
16. The system according to claim 10, further comprising a device (310) for maintaining a computer structure for storing of characteristics profiles in a memory (110).
17. A computer program product, for use together with a computer processing system (106), for registration and analysis of data from a practised stage, and for generation of action programs in dependence of the performed analysis, comprising - a computer storage medium (111),
characterised by:
- means (302), stored on the storage medium, devised to control the computer processing system to receive the input of result data for one or more predetermined parameters from one or several performed stages;
 - calculating means (114, 304), stored on the storage medium, devised to control the computer processing system to calculate, for each of said parameters, a characteristics measurement value for a predetermined characteristics measurement, in dependence of said result data;
 - profile generation means (114, 308), stored on the storage medium, devised to control the computer processing system to generate a characteristics profile by compiling said calculated characteristics measurement values;
 - comparison means (312), stored on the storage medium, devised to control the computer processing system to generate a comparison profile by comparing said characteristics profile with a normal profile, pre-stored in a reference database (311).
18. The computer program product according to claim 17, wherein means (318), stored on the storage medium, for presentation of the comparison profile, is devised to present the comparison profile graphically on a presentation unit (112) connected to the computer processing system.

19. The computer program product according to claims 17 or 18, wherein the comparison means is devised to control the computer processing system to generate a comparison profile by applying a predetermined mathematical operation to the characteristics profile and the normal profile.

5

20. The computer program product according to claim 19, wherein the comparison means is devised to generate a comparison profile in the form of a difference profile (804), by calculating the difference between characteristics measurement values for each parameter (806, 808, 809, 810, 812, 814) of the characteristics profile and the normal profile, respectively.

10

21. The computer program product according to claims 17 or 18, wherein said means (318) for presentation of the comparison profile is devised to visualise, for each parameter (1406, 1408, 1409, 1410, 1412, 1414), a current characteristics measurement value and a normal characteristics measurement value in the same diagram (1404).

15

22. The computer program product according to claim 17, further comprising selection means (314), stored on the storage medium, devised to control the computer processing system to select, in dependence of said characteristics profile or comparison profile, a pre-stored action program.

20

23. The computer program product according to claim 17, wherein said characteristics profile is a profile for a practiser of said stage, whereas said normal characteristics profile is a profile calculated from a group of practisers with common properties.

25

24. The computer program product according to claim 23, wherein said normal profile is a profile for an average practiser within said group.

30

25. The computer program product according to any one of the claims 17 - 24, wherein said practiser is a sports practiser, said stage is one game round of said sport, said parameter is a game parameter and said action program is a training model for improvement of the practiser's player properties within said sport.

35

26. The computer program product according to claim 25, further comprising means (302), stored on the storage medium, devised to control the computer processing system to receive input player data for the sports practiser; and wherein

said normal profile is based upon corresponding player data, for example age group, sex, handicap or ranking.

27. The computer program product according to claim 25, wherein said means
5 (318) for presentation of the comparison profile further is devised to visually
present, on said presentation unit (112), the characteristics profile or the comparison
profile in the form of a bar diagram (404, 504, 604, 704, 804, 1004, 1104, 1204)
having one bar for each game parameter, where the bar height corresponds to the
characteristics measurement value.

10 28. The computer program product according to claim 23, wherein said means
(318) for presentation of the comparison profile further is devised to visually
present, on said presentation unit (112), the characteristics profile or the comparison
profile in the form of a curve chart (904, 1404), where the level of the curve for each
15 game parameter corresponds to the characteristics measurement value.

29. The computer program product according to claim 25, further being adapted
for the analysis of the player properties of a golfer, whereby the game parameters are
various shot types and the characteristics measurement is the average number of shots
20 per round.

30. The computer program product according to claim 25, adapted for the analy-
sis of the player properties of a tennis player, whereby the game parameters are vari-
ous shot types and the characteristics measurement is the percentage distribution of
25 successful shots in relation to unsuccessful ones.

31. The computer program product according to claim 25, further comprising
means (314), stored on the storage medium, devised to control the computer
processing system to maintain a computer structure for storing of characteristics
30 measurement values in a memory (110).

32. The computer program product according to claim 25, further comprising
means (310), stored on the storage medium, devised to control the computer
processing system to maintain a computer structure for storing of characteristics pro-
35 files in a memory (110).

33. A method for registering and analysing data from a practised stage, and for
generating action programs in dependence of the performed analysis, characterised
by the steps of:

- registering result data (204) for one or more predetermined parameters from one or several performed stages;
 - calculating (206), for each of said parameters, a characteristics measurement value for a predetermined characteristics measurement;
 - 5 - generating (298) a characteristics profile by compiling said calculated characteristics measurement values;
 - generating a comparison profile (214) by comparing said characteristics profile with a pre-stored normal profile.
- 10 34. The method according to claim 33, further comprising the step of graphically presenting (216) the comparison profile on a presentation unit connected to the computer processing system.
- 15 35. The method according to claims 33 or 34, further comprising the step of generating a comparison profile by applying a predetermined mathematical operation to the characteristics profile and the normal profile.
- 20 36. The method according to claim 34, whereby a comparison profile in the form of a difference profile is generated by calculating the difference between characteristics measurement values for each parameter of the characteristics profile and the normal profile, respectively.
- 25 37. The method according to claim 34, further comprising the step of visualising, for each parameter, a current characteristics measurement value and a normal characteristics measurement value in the same diagram.
- 30 38. The method according to claim 33, further comprising the step of selecting (220), in dependence of said characteristics profile or comparison profile, a pre-stored action program.
- 35 39. The method according to claim 38, further comprising the step of visually presenting (222) instructions and figures associated with the current action program.
40. The method according to claim 33, whereby said characteristics profile is a profile for a practiser of said stage, whereas said normal characteristics profile is a profile calculated from a group of practisers with common properties.
41. The method according to claim 34, whereby said normal profile is a profile for an average practiser within said group.

42. The method according to any one of claims 33 - 41, whereby said practiser is a sports practiser, said stage is one game round of said sport, said parameter is a game parameter and said action program is a training model for improvement of the practiser's player properties within said sport.
43. The method according to claim 42, further comprising the step of registering player data (204) for the sports practiser; and whereby said normal profile is based upon corresponding player data, for example age group, sex, handicap or ranking.
44. The method according to claim 42, further comprising the step of visually presenting (210, 216) the characteristics profile or the comparison profile in the form of a bar diagram having one bar for each game parameter, where the bar height corresponds to the characteristics measurement value.
45. The method according to claim 42, further comprising the step of visually presenting (210, 216) the characteristics profile or the comparison profile in the form of a curve chart (904, 1404), where the level of the curve for each game parameter corresponds to the characteristics measurement value.
46. The method according to claim 42, adapted for the analysis of the player properties of a golfer, whereby the game parameters are various shot types and the characteristics measurement is the average number of shots per round.
47. The method according to claim 42, adapted for the analysis of the player properties of a tennis player, whereby the game parameters are various shot types and the characteristics measurement is the percentage distribution of successful shots in relation to unsuccessful ones.

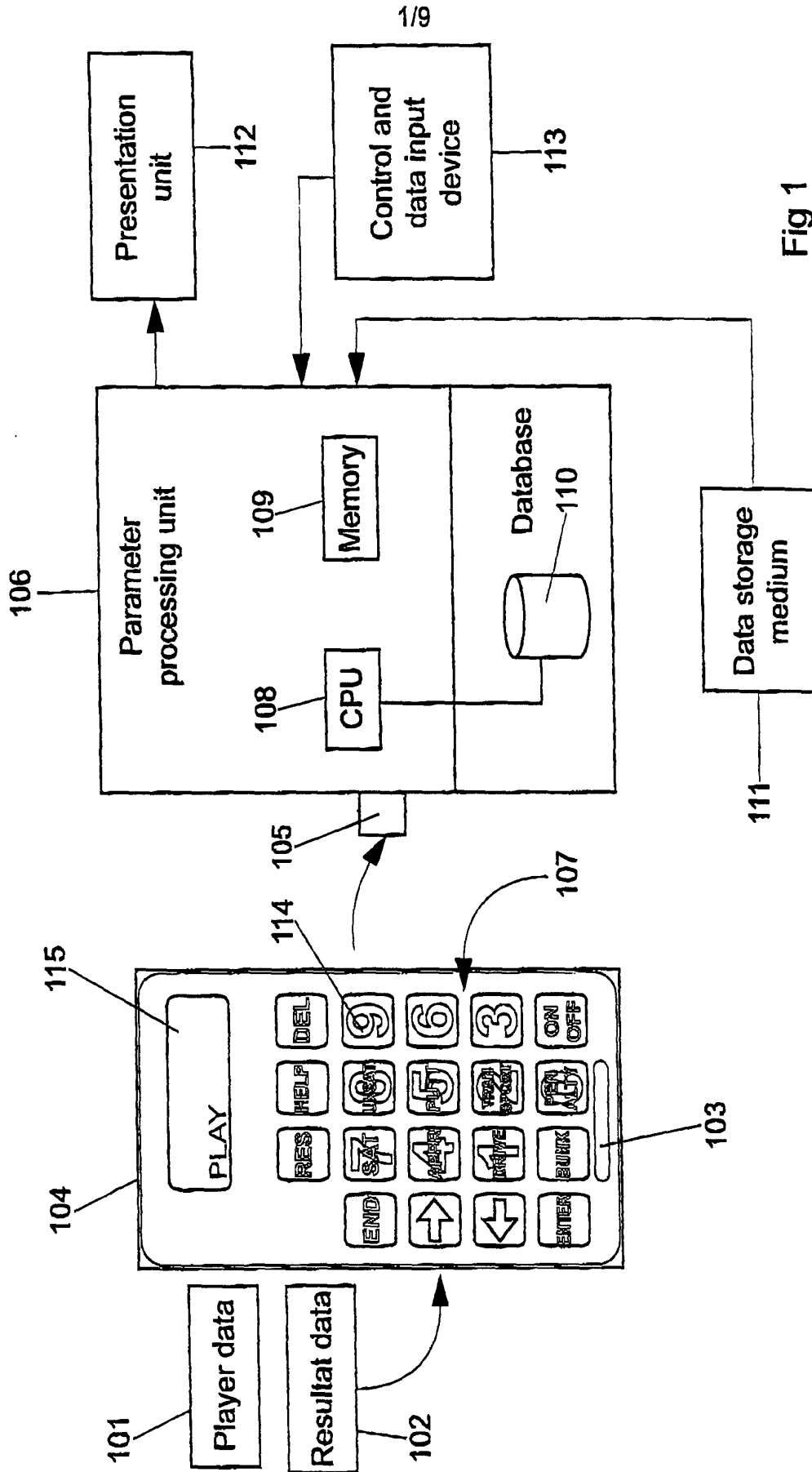

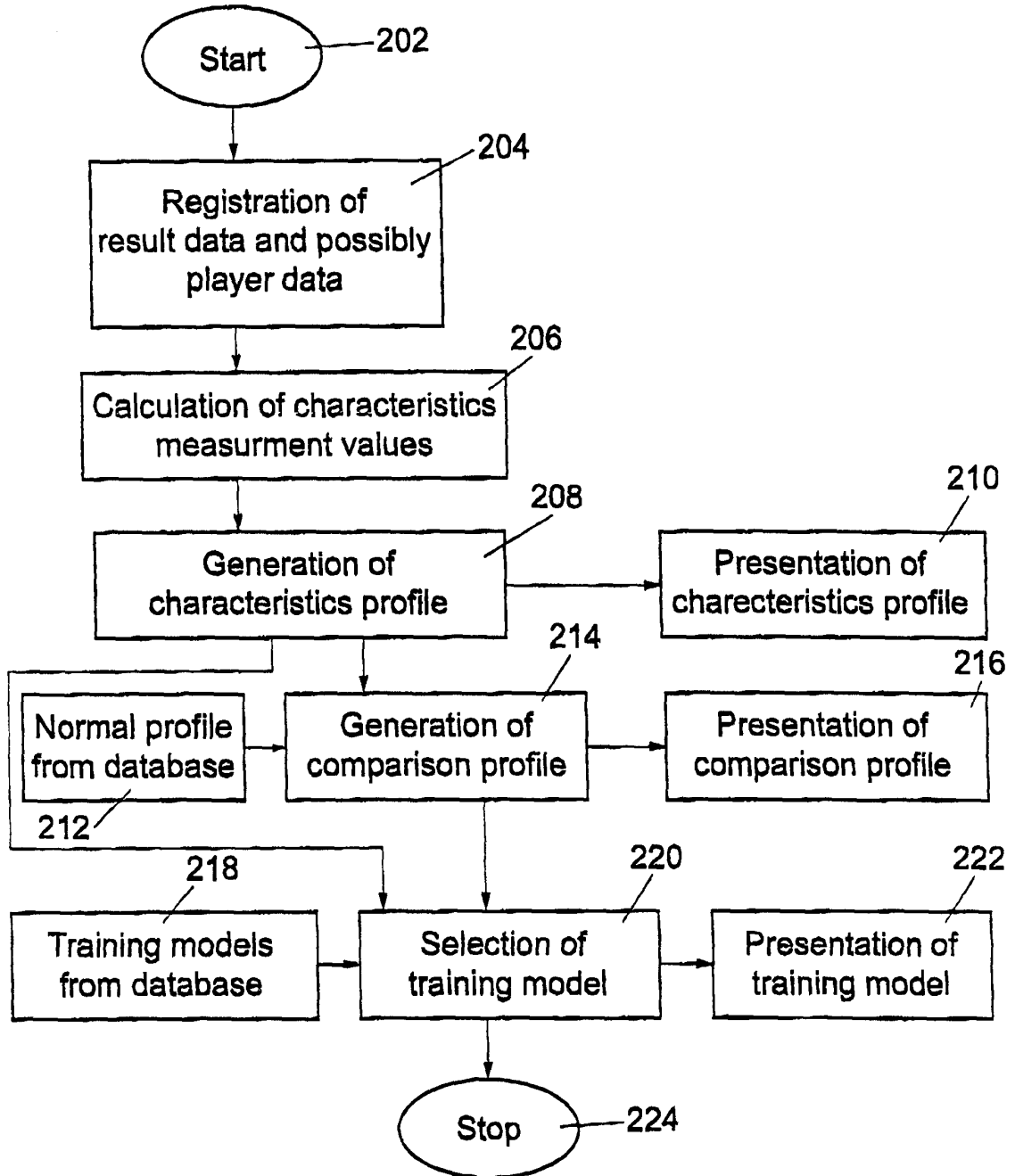

Fig 2

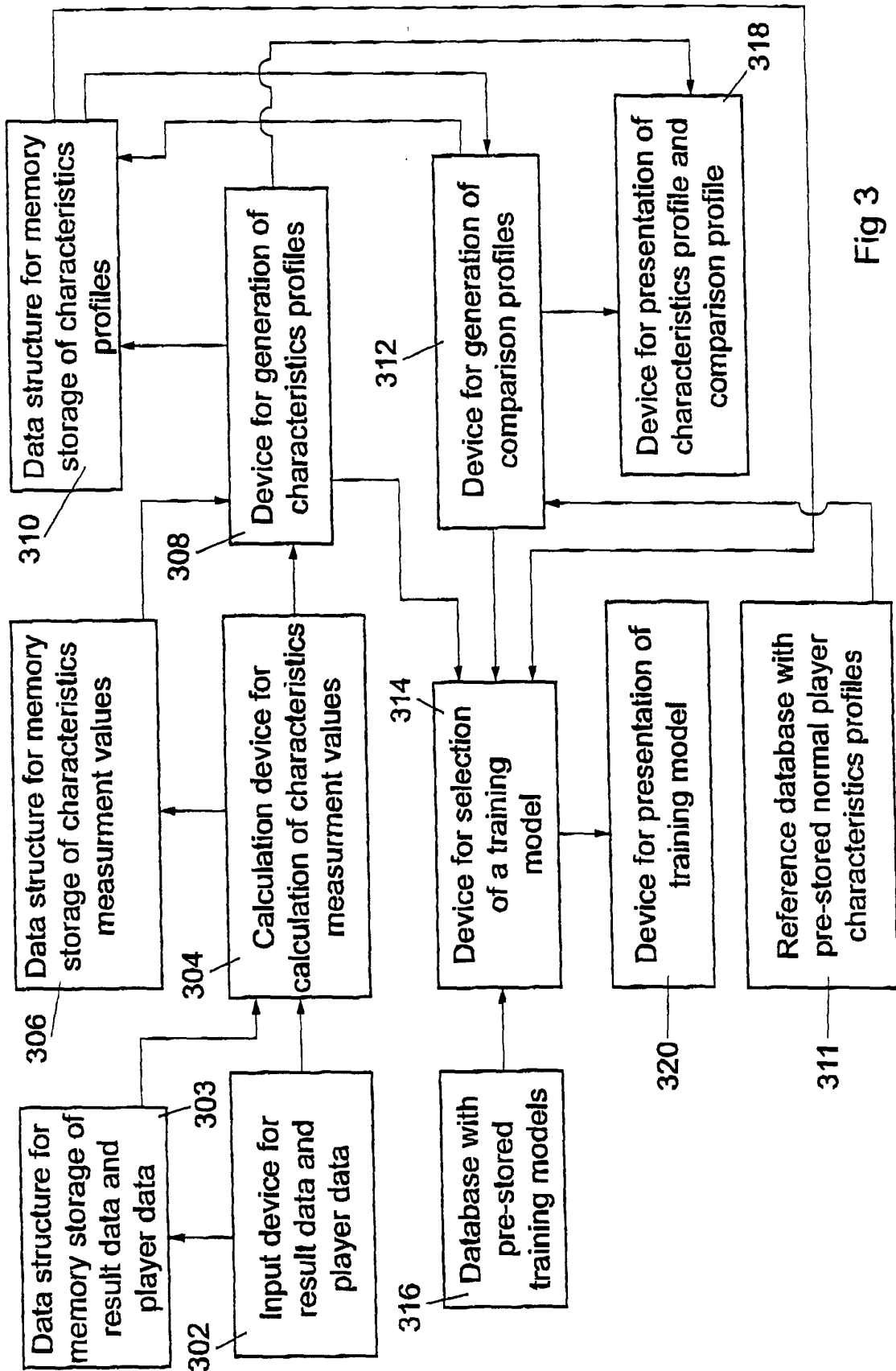

Fig 3

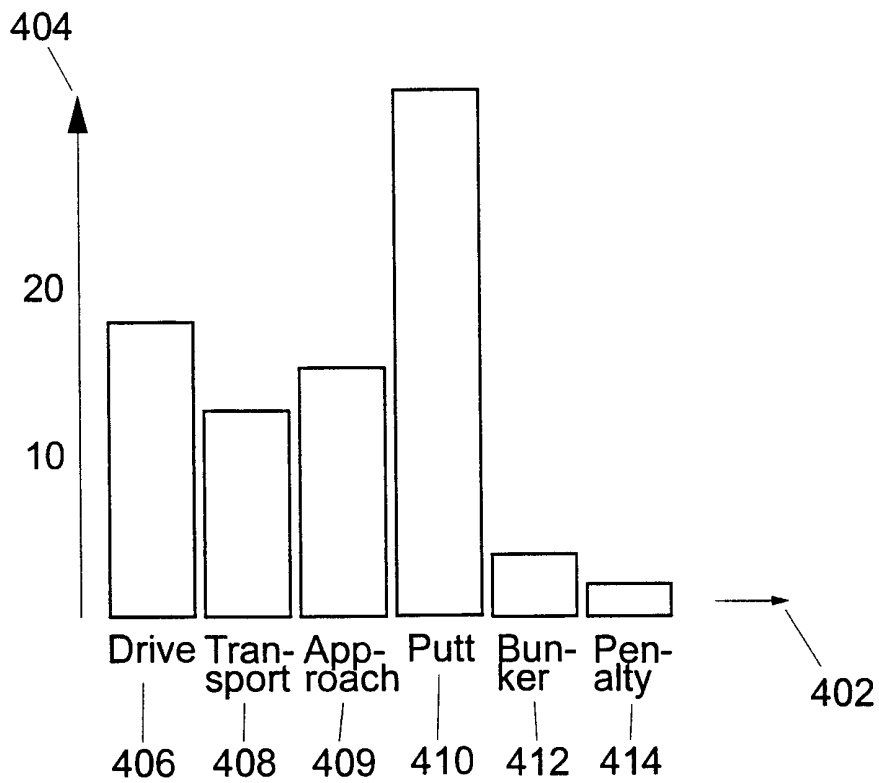

Fig 4

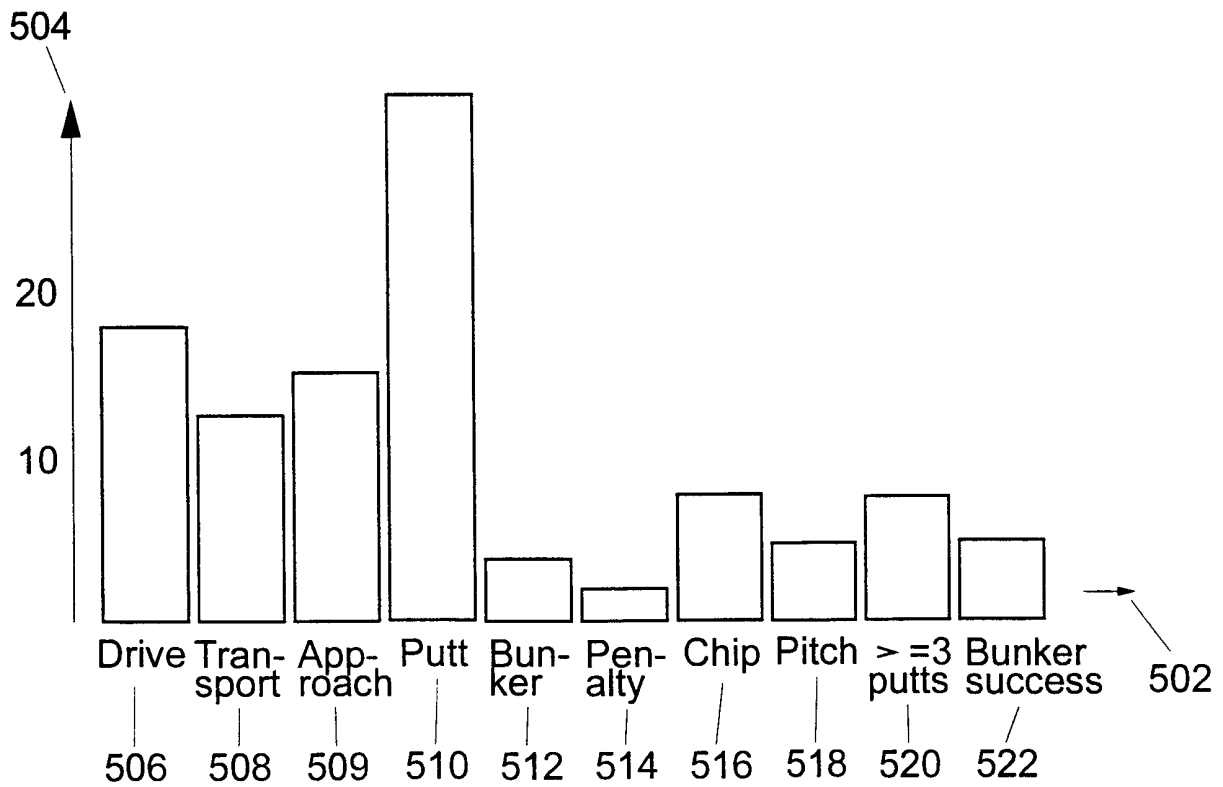
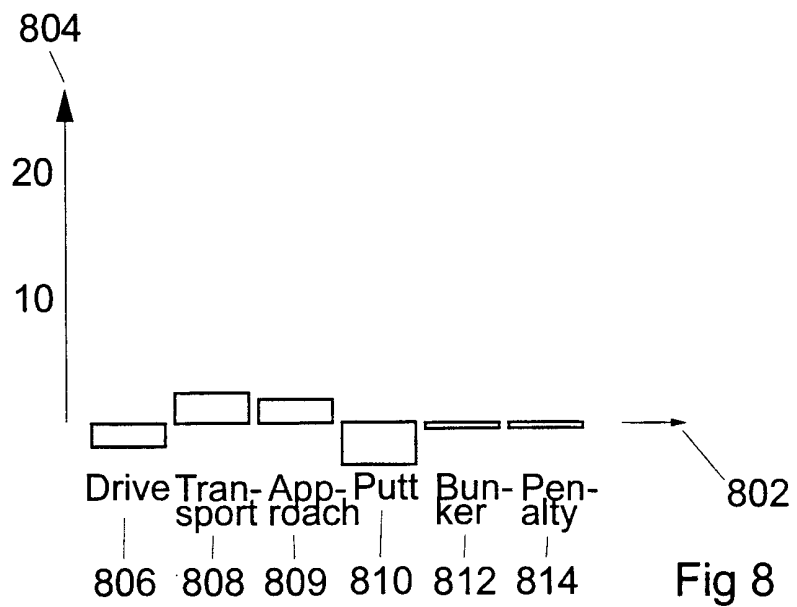
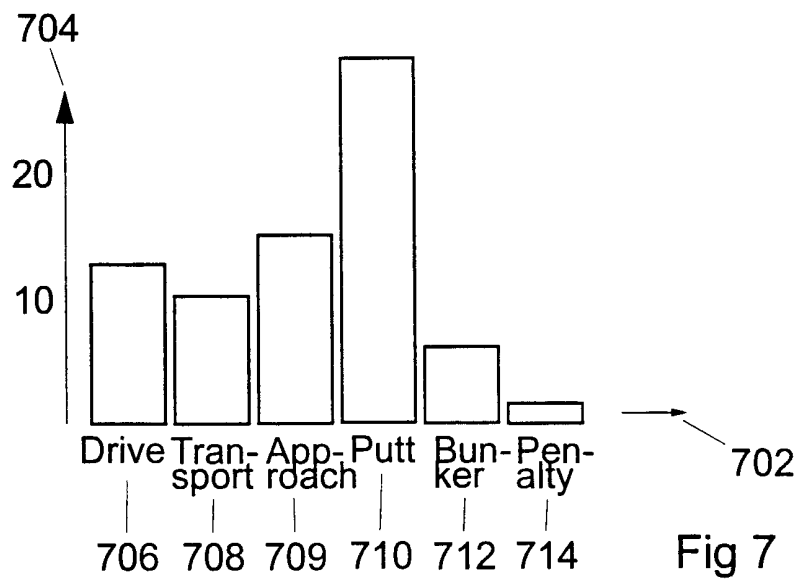
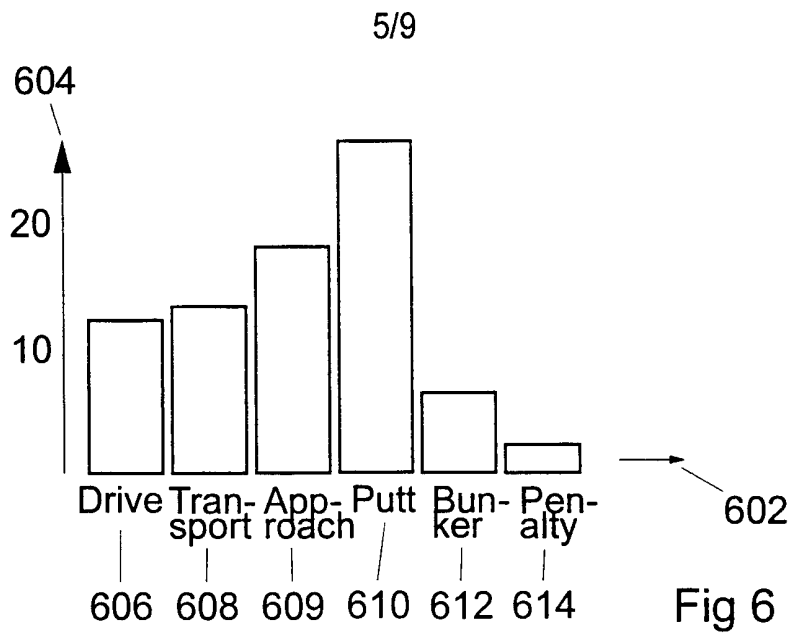
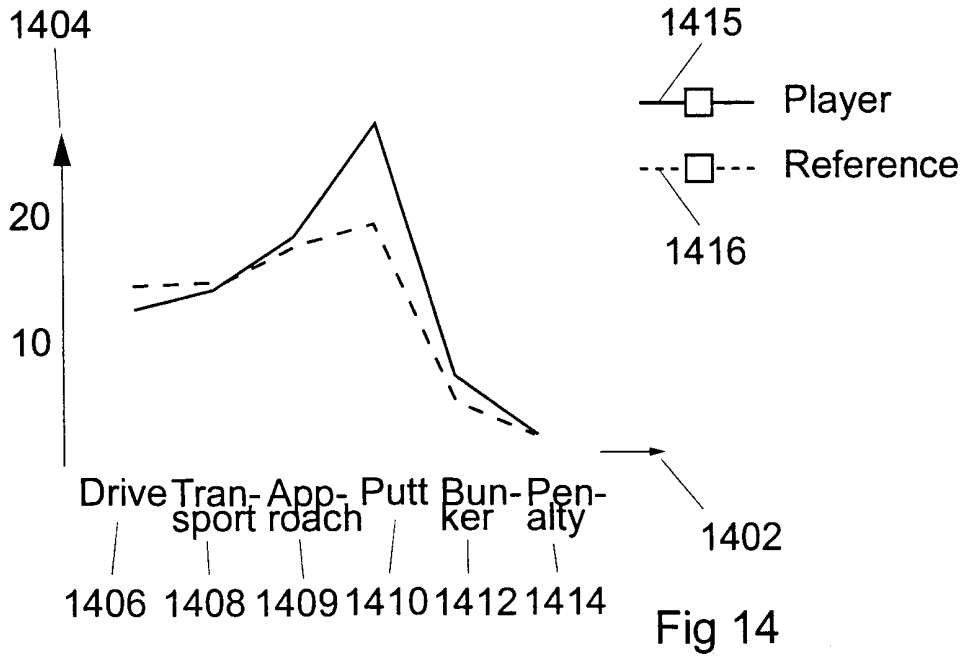
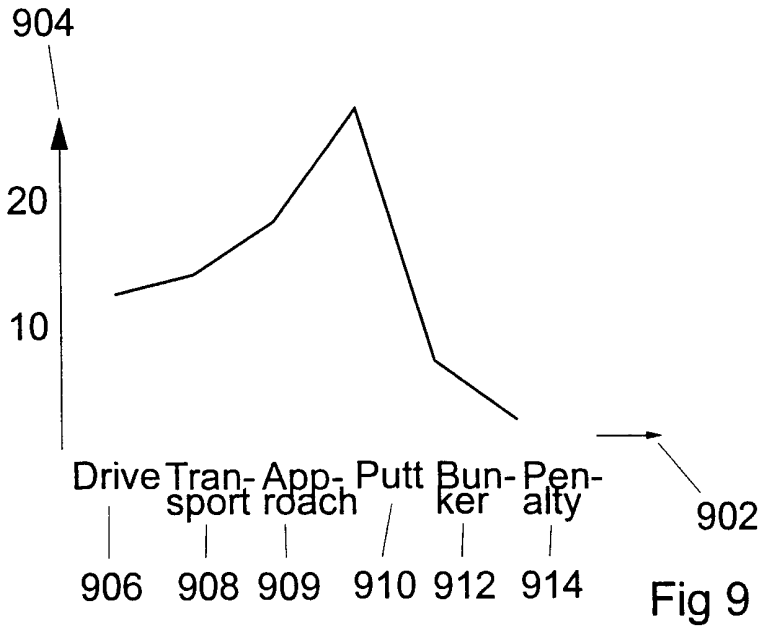

Fig 5





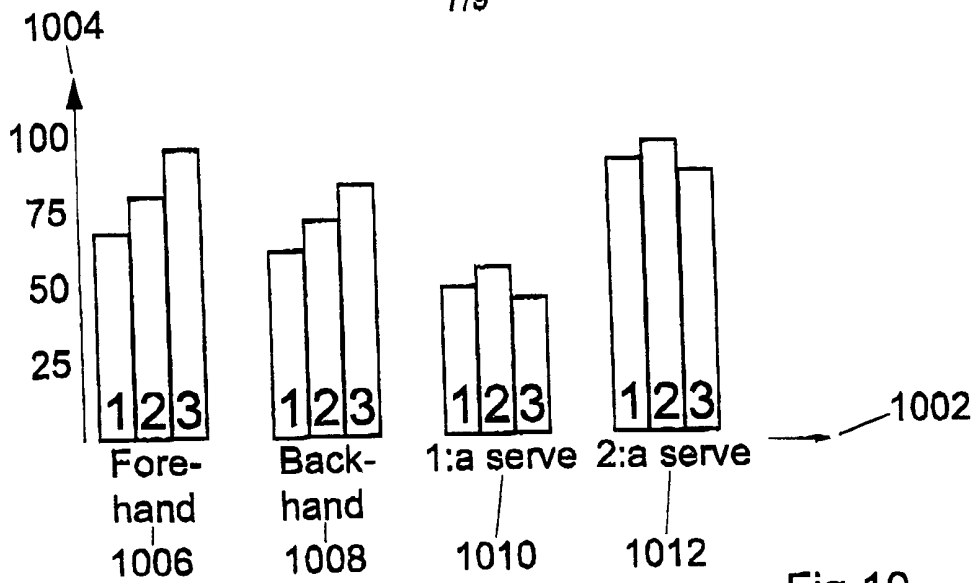

Fig 10

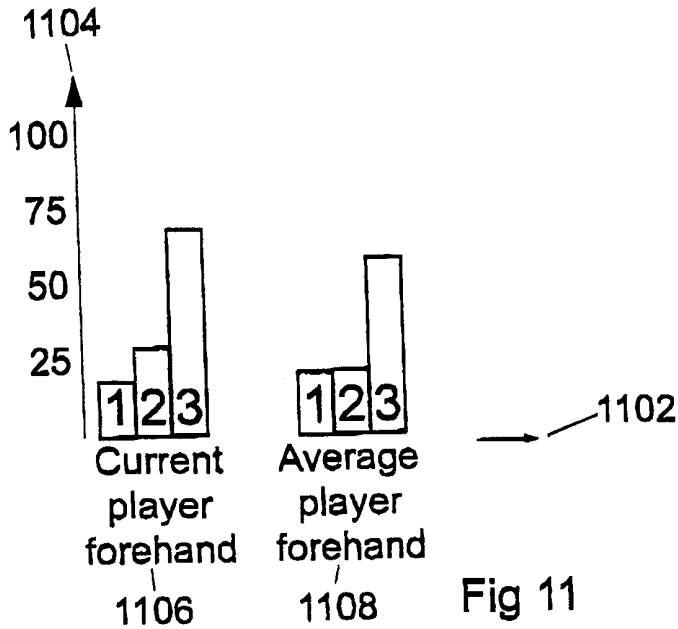

Fig 11



Fig 12

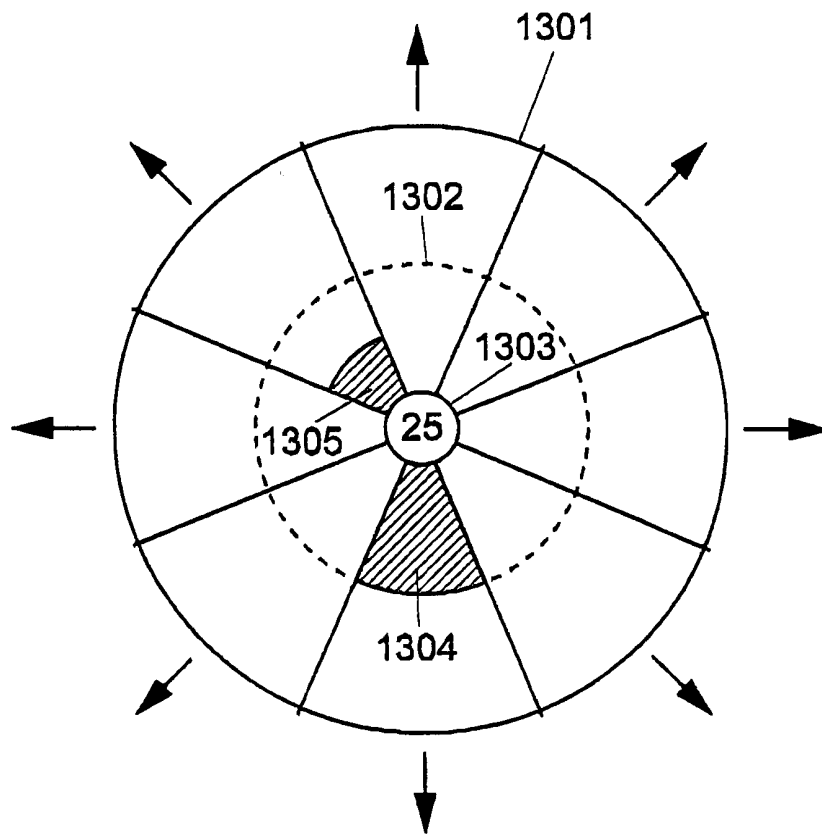

Fig 13

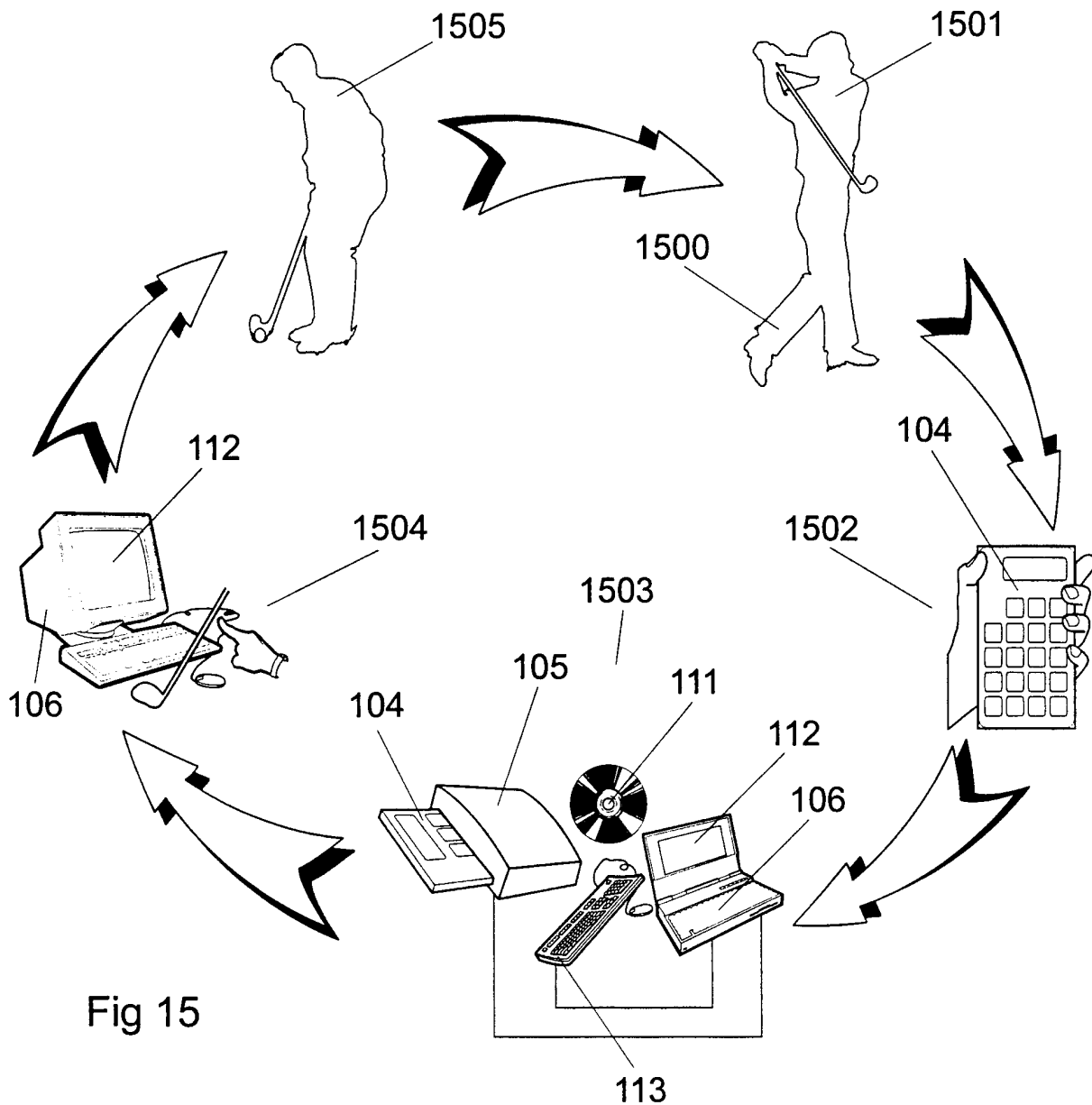

Fig 15

INTERNATIONAL SEARCH REPORT

International application No.

PCT/SE 00/01501

A. CLASSIFICATION OF SUBJECT MATTER

IPC7: A63B 71/06

According to International Patent Classification (IPC) or to both national classification and IPC

B. FIELDS SEARCHED

Minimum documentation searched (classification system followed by classification symbols)

IPC7: A63B

Documentation searched other than minimum documentation to the extent that such documents are included in the fields searched

SE,DK,FI,NO classes as above

Electronic data base consulted during the international search (name of data base and, where practicable, search terms used)

EPODOC, WPI

C. DOCUMENTS CONSIDERED TO BE RELEVANT

Category*	Citation of document, with indication, where appropriate, of the relevant passages	Relevant to claim No.
X	WO 9742588 A1 (WESTGARD QUALITY CORPORATION), 13 November 1997 (13.11.97) --	1-5,17-21, 33-37
X	US 5558333 A (S.M. KELSON ET AL), 24 Sept 1996 (24.09.96) --	1-5,7,8, 17-21,23,24, 28,33-37,40, 41
X	US 5810680 A (L.P. LOBB ET AL), 22 Sept 1998 (22.09.98) --	1-5,7,8, 17-21,23,24, 28,33-37,40, 41

 Further documents are listed in the continuation of Box C. See patent family annex.

* Special categories of cited documents:

"A" document defining the general state of the art which is not considered to be of particular relevance

"E" earlier document but published on or after the international filing date

"L" document which may throw doubts on priority claim(s) or which is cited to establish the publication date of another citation or other special reason (as specified)

"O" document referring to an oral disclosure, use, exhibition or other means

"P" document published prior to the international filing date but later than the priority date claimed

"T" later document published after the international filing date or priority date and not in conflict with the application but cited to understand the principle or theory underlying the invention

"X" document of particular relevance: the claimed invention cannot be considered novel or cannot be considered to involve an inventive step when the document is taken alone

"Y" document of particular relevance: the claimed invention cannot be considered to involve an inventive step when the document is combined with one or more other such documents, such combination being obvious to a person skilled in the art

"&" document member of the same patent family

Date of the actual completion of the international search

25 October 2000

Date of mailing of the international search report

27-10-2000

Name and mailing address of the ISA/

Swedish Patent Office
Box 5055, S-102 42 STOCKHOLM
Facsimile No. +46 8 666 02 86

Authorized officer

Christer Bäcknert / MRo
Telephone No. +46 8 782 25 00

INTERNATIONAL SEARCH REPORT

International application No.

PCT/SE 00/01501

C (Continuation). DOCUMENTS CONSIDERED TO BE RELEVANT

Category*	Citation of document, with indication, where appropriate, of the relevant passages	Relevant to claim No.
X	US 5882269 A (R.D. LEWIS), 16 March 1999 (16.03.99) --	1-5,7,8, 17-21,23,24, 28,33-37,40, 41
X	FRED S. COX: Golfing and your Palm organizer url:www.palmpower.com/issuesprint/issue1199812/golf. html. (retrieved on 2000-02-10) -- -----	1-5,7,8, 17-21,23,24, 28,33-37,40, 41

INTERNATIONAL SEARCH REPORT
 Information on patent family members

International application No.
PCT/SE 00/01501

Patent document cited in search report			Publication date	Patent family member(s)		Publication date
WO	9742588	A1	13/11/97	CA	2226116 A	13/11/97
				GB	2318197 A	15/04/98
				GB	9800205 D	00/00/00
				US	5937364 A	10/08/99

US	5558333	A	24/09/96	NONE		

US	5810680	A	22/09/98	NONE		

US	5882269	A	16/03/99	US	5645499 A	08/07/97
