



US0D1027378S

(12) **United States Design Patent**
Pearson

(10) **Patent No.:** **US D1,027,378 S**

(45) **Date of Patent:** **** May 21, 2024**

(54) **UNDERWEAR WITH POCKETS FOR
PADDING ELEMENTS**

(71) Applicant: **Gunder LLC**, Greer, SC (US)

(72) Inventor: **David Pearson**, Greer, SC (US)

(**) Term: **15 Years**

(21) Appl. No.: **29/851,289**

(22) Filed: **Aug. 26, 2022**

(51) **LOC (14) Cl.** **02-02**

(52) **U.S. Cl.**
USPC **D2/712**

(58) **Field of Classification Search**
USPC D2/701, 704, 712
CPC .. A41B 9/00; A41B 9/02; A41B 9/004; A41B
9/023; A41B 9/007
See application file for complete search history.

(56) **References Cited**

U.S. PATENT DOCUMENTS

| | | | | |
|-------------------|---------|------------|-------|---------------|
| D31,771 S * | 10/1899 | Scriven | | D2/712 |
| 2,235,849 A * | 3/1941 | Reis | | A41B 9/02 |
| | | | | 2/234 |
| 2,269,120 A * | 1/1942 | McCarthy | | A41B 9/02 |
| | | | | 2/234 |
| D191,908 S * | 12/1961 | Goldstein | | D2/712 |
| 3,285,248 A * | 11/1966 | Williams | | A41C 1/00 |
| | | | | 450/122 |
| 2013/0174328 A1 * | 7/2013 | Rolon | | A41B 9/023 |
| | | | | 2/403 |
| 2014/0047620 A1 * | 2/2014 | Ingalls | | A41B 9/02 |
| | | | | 2/403 |
| 2015/0320118 A1 * | 11/2015 | Frantz | | D04B 1/243 |
| | | | | 2/403 |
| 2020/0015526 A1 * | 1/2020 | Brown, Sr. | | A61F 13/49006 |
| 2021/0100681 A1 * | 4/2021 | Miles | | A41B 9/14 |

(Continued)

OTHER PUBLICATIONS

Pracmanu Men's Underwear with 2 Secret Zipper Pockets , posted Mar. 29, 2022 [online], (retrieved Mar. 18, 2024). Retrieved from the internet, <https://www.amazon.in/PRACMANU-Underwear-Pockets-Breathable-Underpants/dp/B08WR7WDM7> (Year: 2022).*

(Continued)

Primary Examiner — Kevin K Rudzinski

Assistant Examiner — J. Thorn, Sr.

(74) *Attorney, Agent, or Firm* — Rutan & Tucker, LLP;
Kyle M. St. James

(57) **CLAIM**

I claim the ornamental design for underwear with pockets for padding elements, substantially as shown and described.

DESCRIPTION

FIG. 1 is a front perspective view of the underwear with pockets for padding elements, showing the first embodiment of my new design;

FIG. 2 is a front view of the first embodiment;

FIG. 3 is a rear view of the first embodiment;

FIG. 4 is a right-side view of the first embodiment;

FIG. 5 is a left side-view of the first embodiment;

FIG. 6 is a top view of the first embodiment;

FIG. 7 is a bottom view of the first embodiment;

FIG. 8 is a front perspective view of the underwear with pockets for padding elements, showing the second embodiment;

FIG. 9 is a front view of the second embodiment;

FIG. 10 is a rear view of the second embodiment;

FIG. 11 is a right-side view of the second embodiment;

FIG. 12 is a left side-view of the second embodiment;

FIG. 13 is a top view of the second embodiment; and,

FIG. 14 is a bottom view of the second embodiment.

The broken lines shown in the drawings depict portions of the garment that form no part of the claimed design.

1 Claim, 12 Drawing Sheets

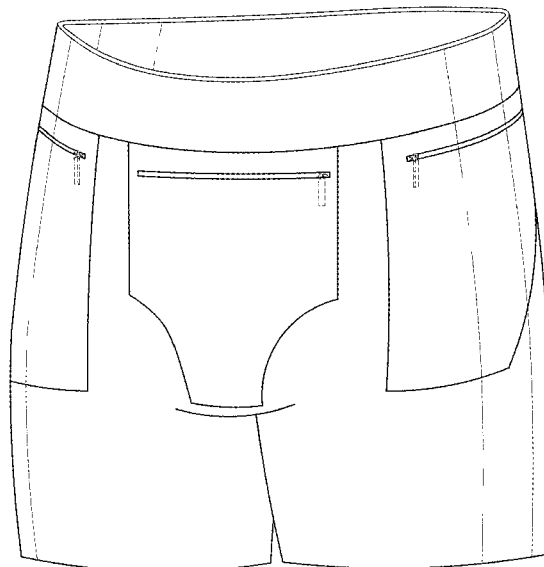

(56)

References Cited

U.S. PATENT DOCUMENTS

2022/0192278 A1* 6/2022 Brown, Sr. A41D 1/065
2022/0346461 A1* 11/2022 Wittrock G06Q 30/0621

OTHER PUBLICATIONS

LaseVe Men's Pouch Underwear, posted Aug. 7, 2023 [online],
(retrieved Mar. 18, 2024). Retrieved from the internet, <https://www.amazon.com/LaseVe-Underwear-Breathable-Travel-Panties/dp/B0CDXX6GPQ?th=1> (Year: 2023).*

Men's underwear with hidden safety pockets, reviewed Sep. 12,
2013 [online], (retrieved Mar. 18, 2024). Retrieved from the internet,
<https://www.clevertravelcompanion.com/products/mens-pocket-underwear> (Year: 2013).*

* cited by examiner

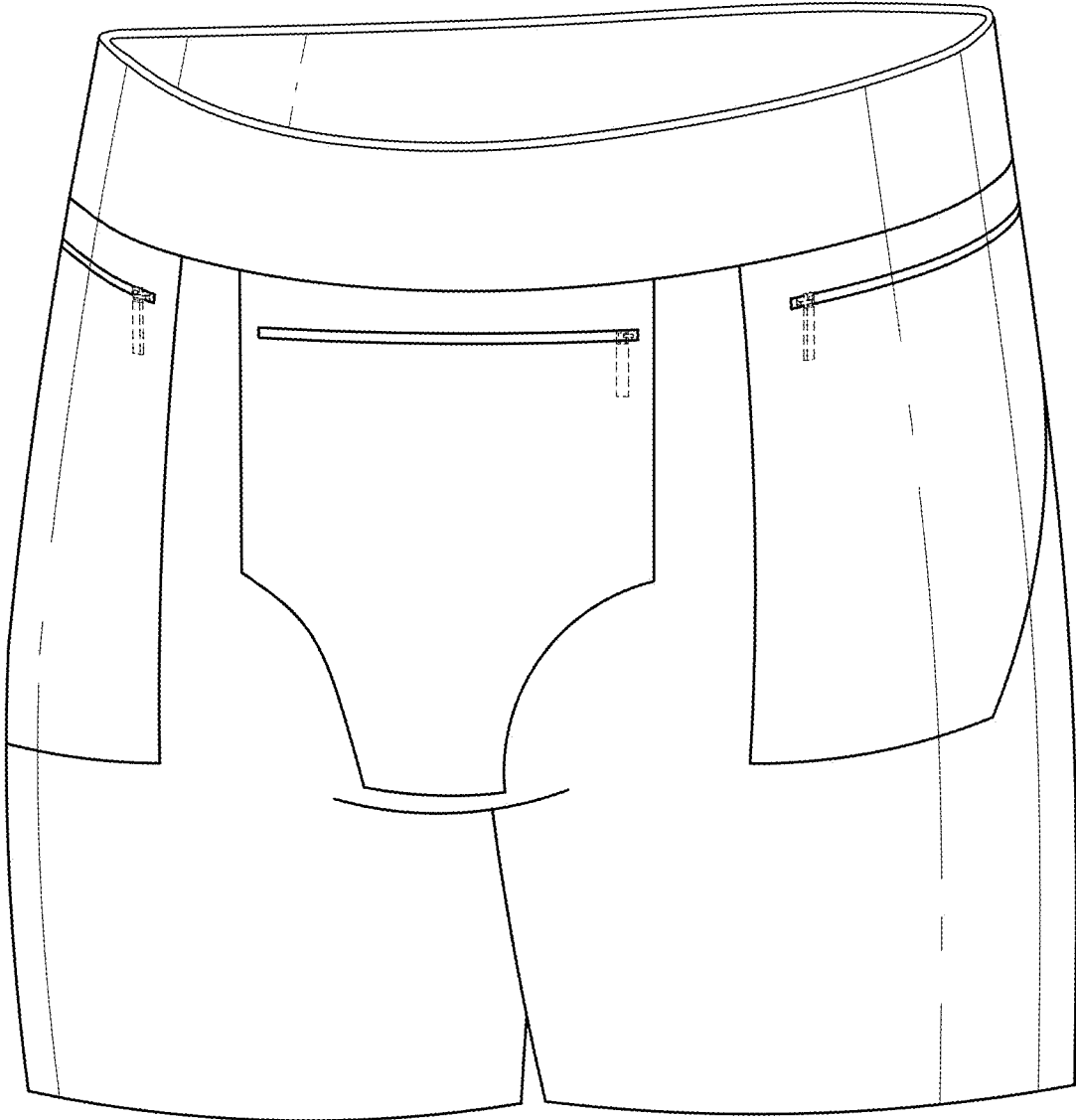

FIG. 1

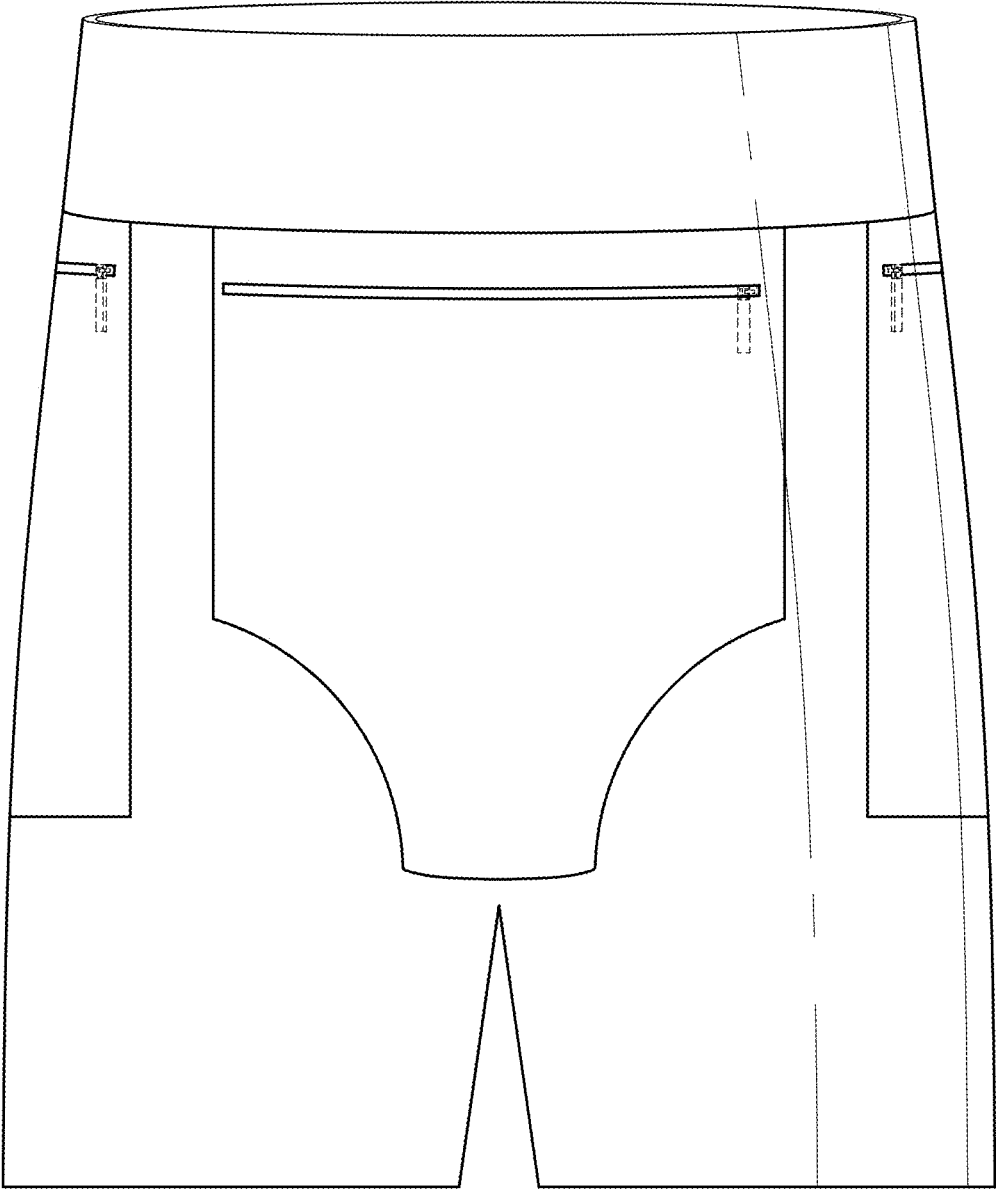

FIG. 2

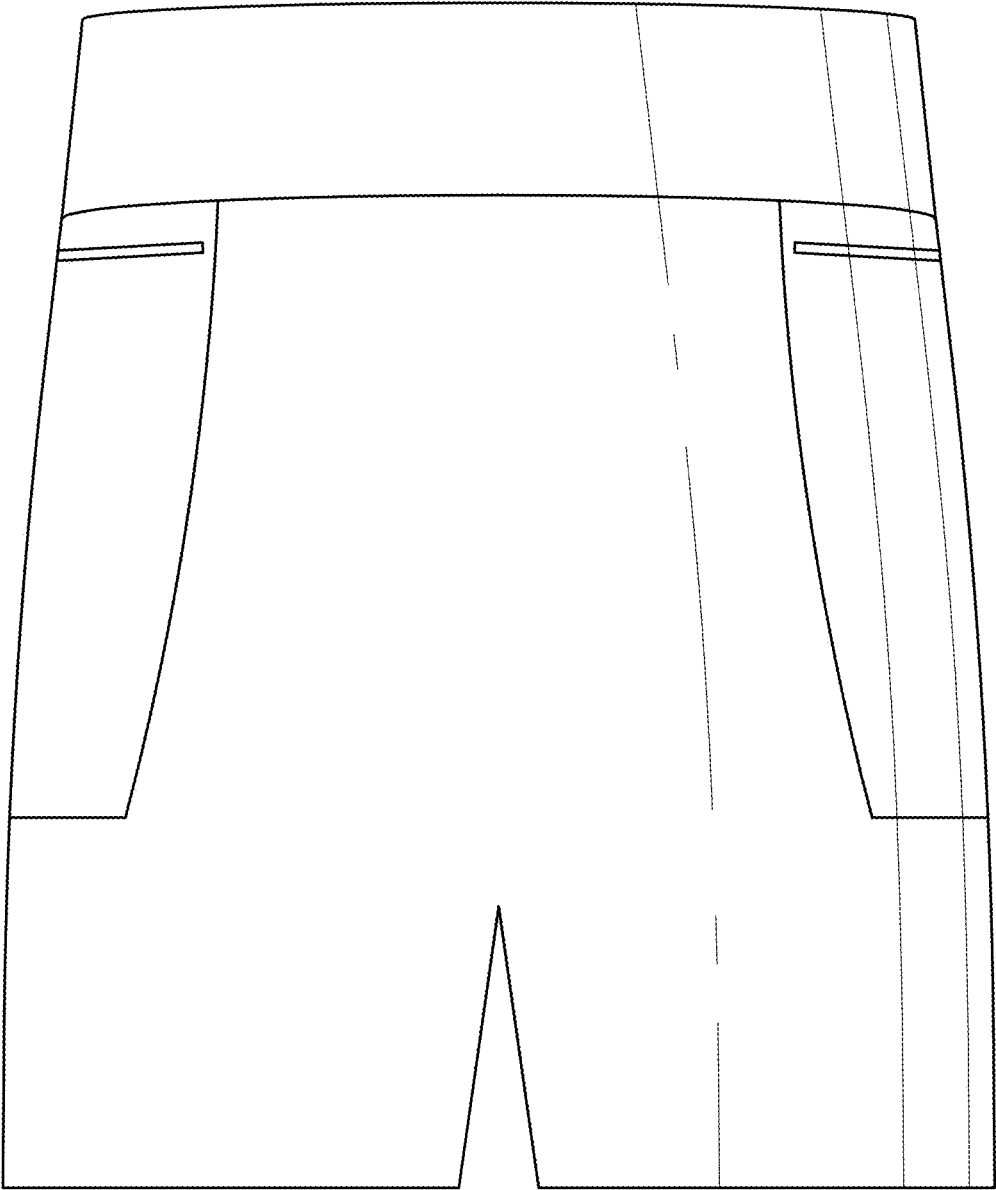

FIG. 3

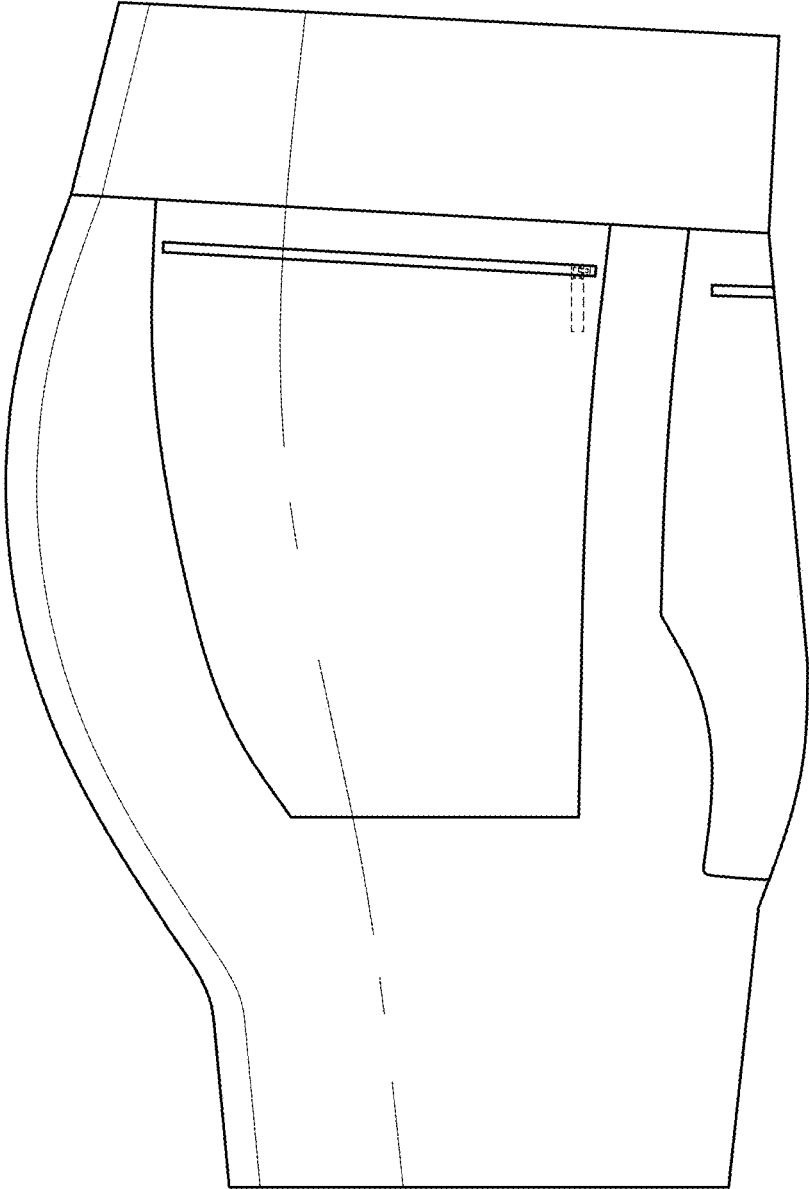

FIG. 4

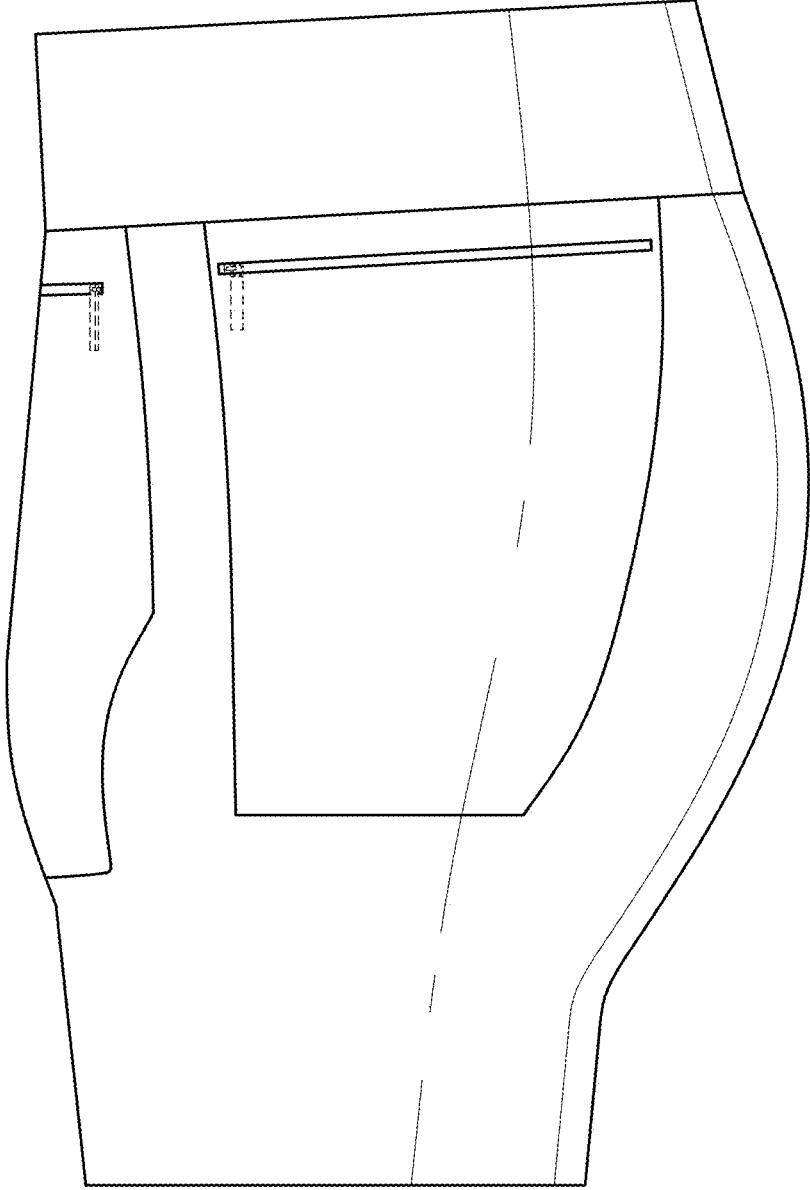

FIG. 5

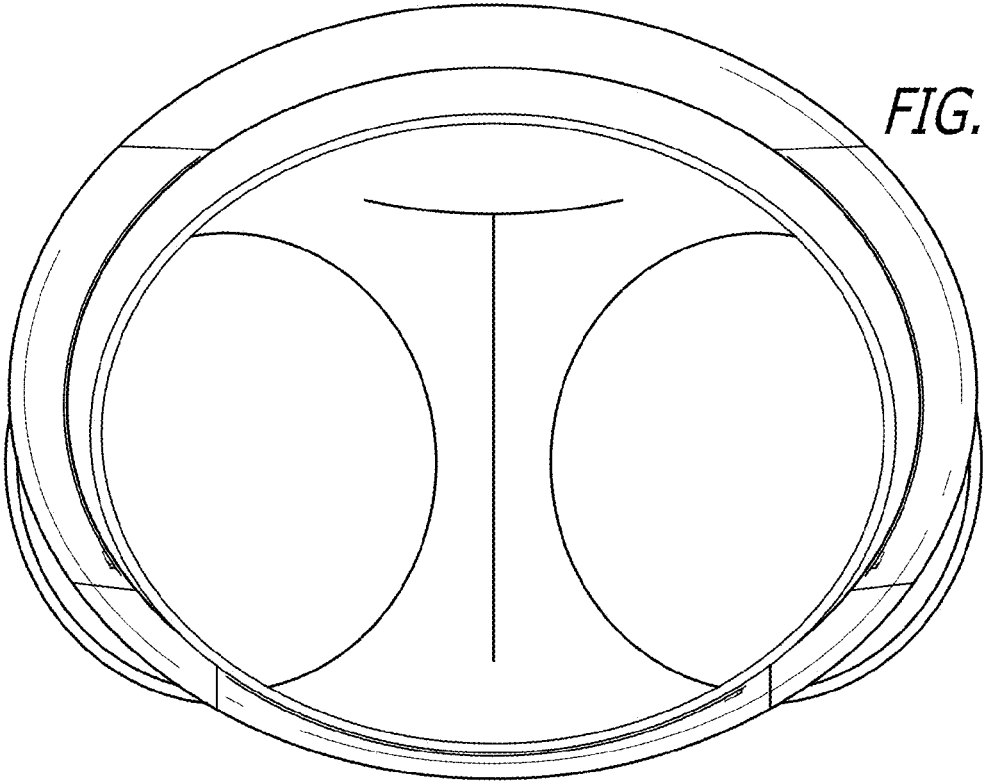

FIG. 6

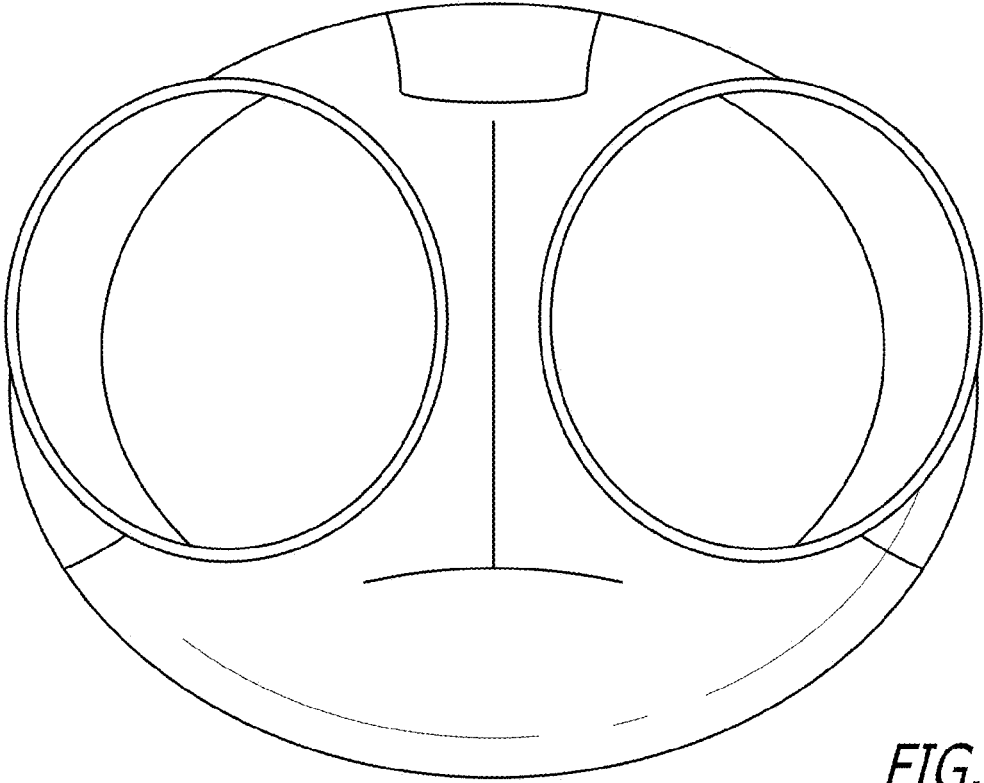

FIG. 7

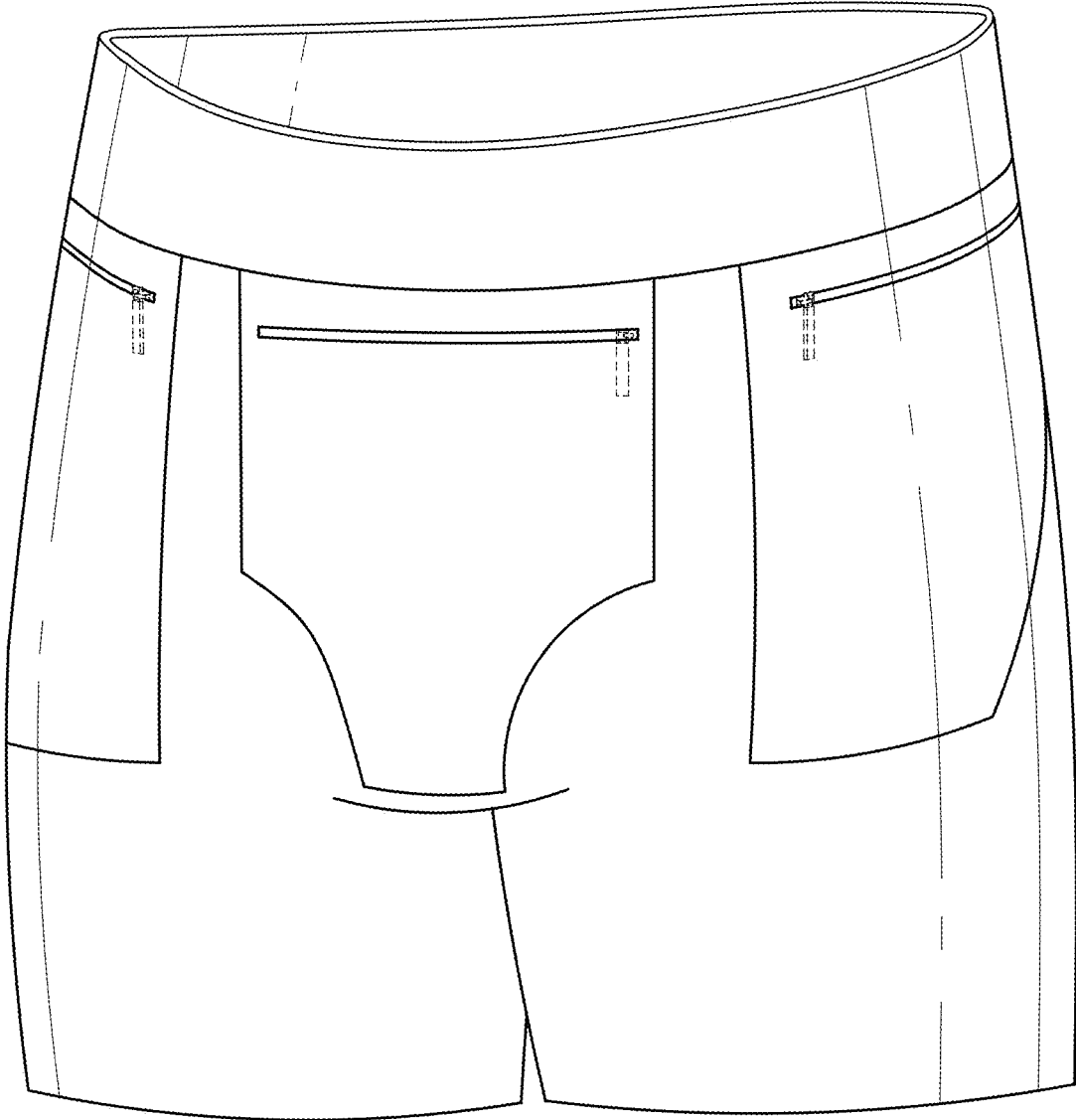

FIG. 8

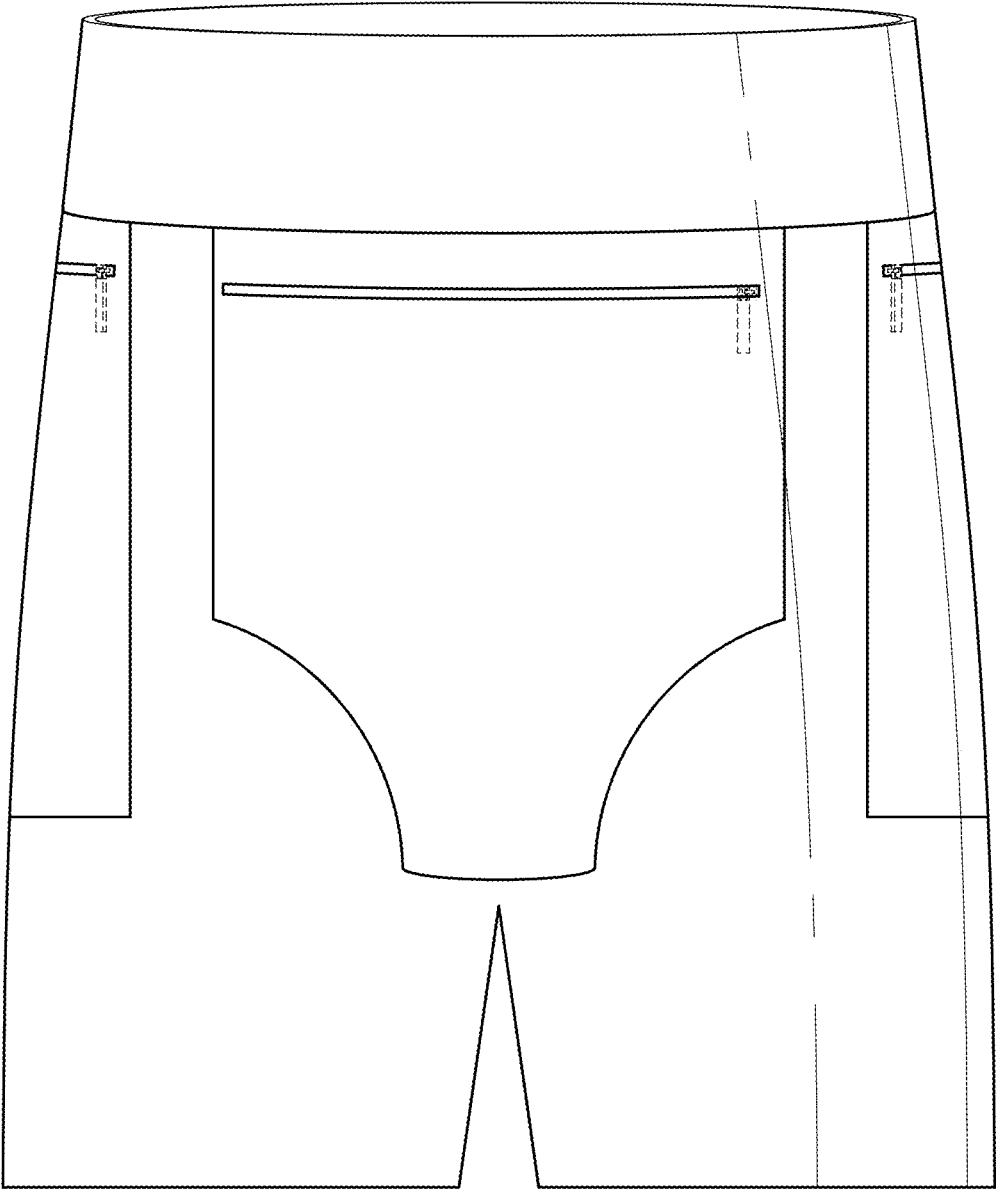

FIG. 9

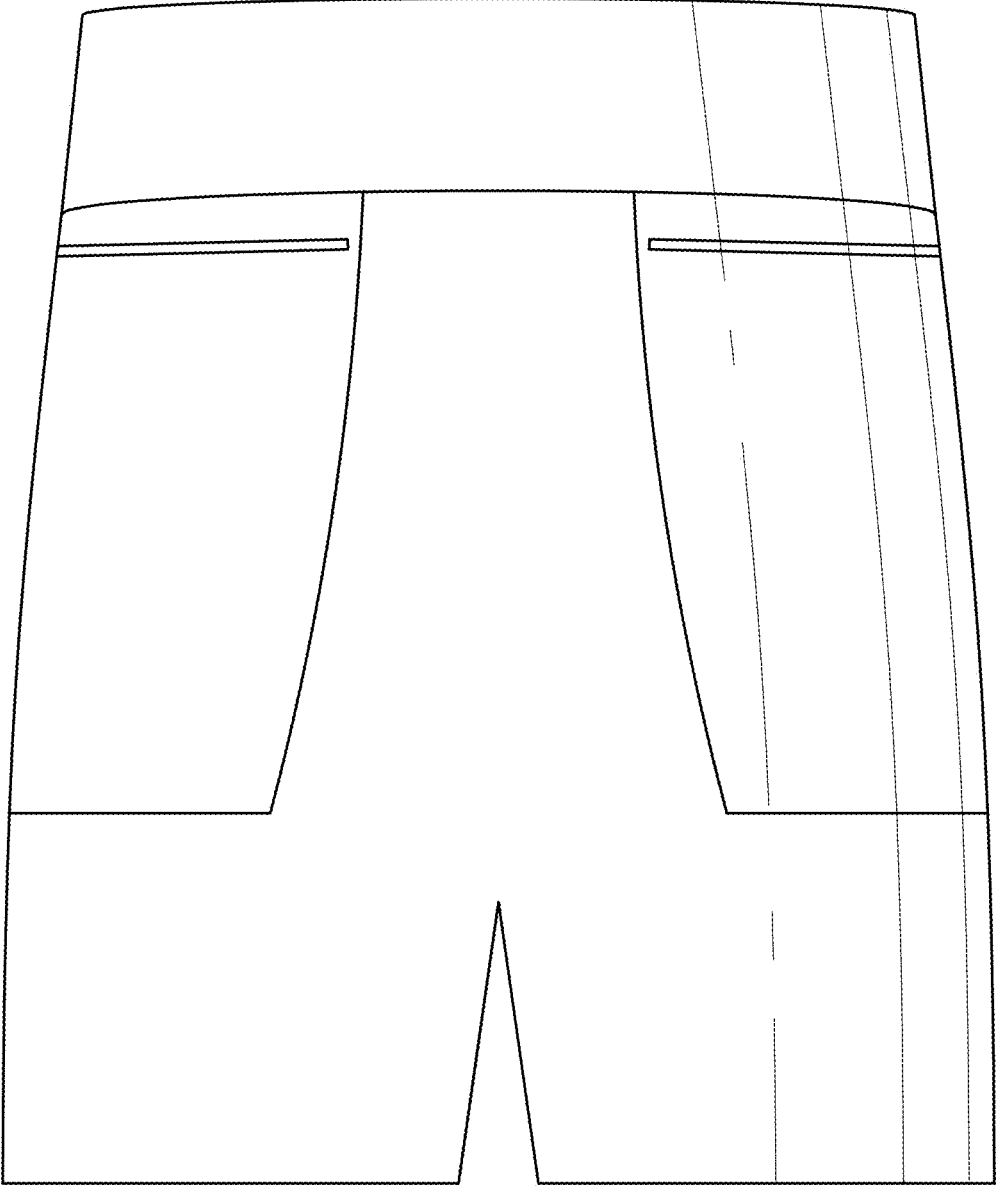

FIG. 10

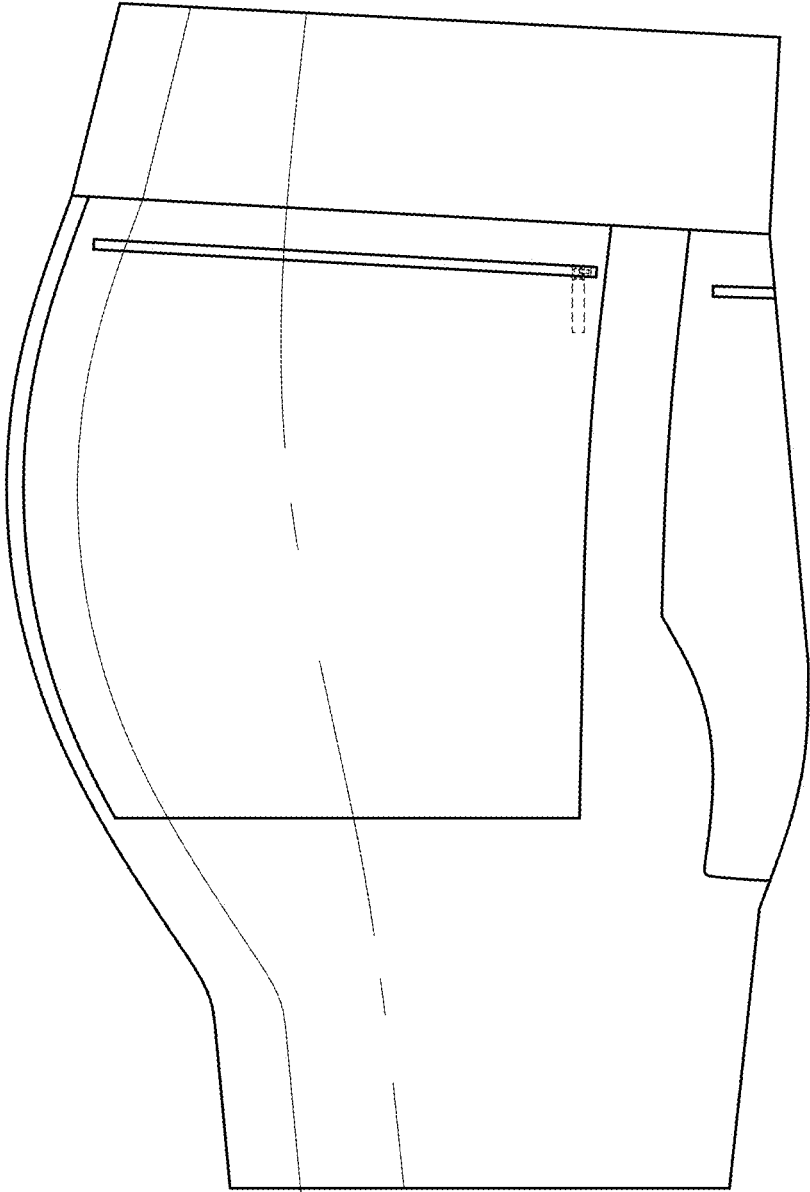

FIG. 11

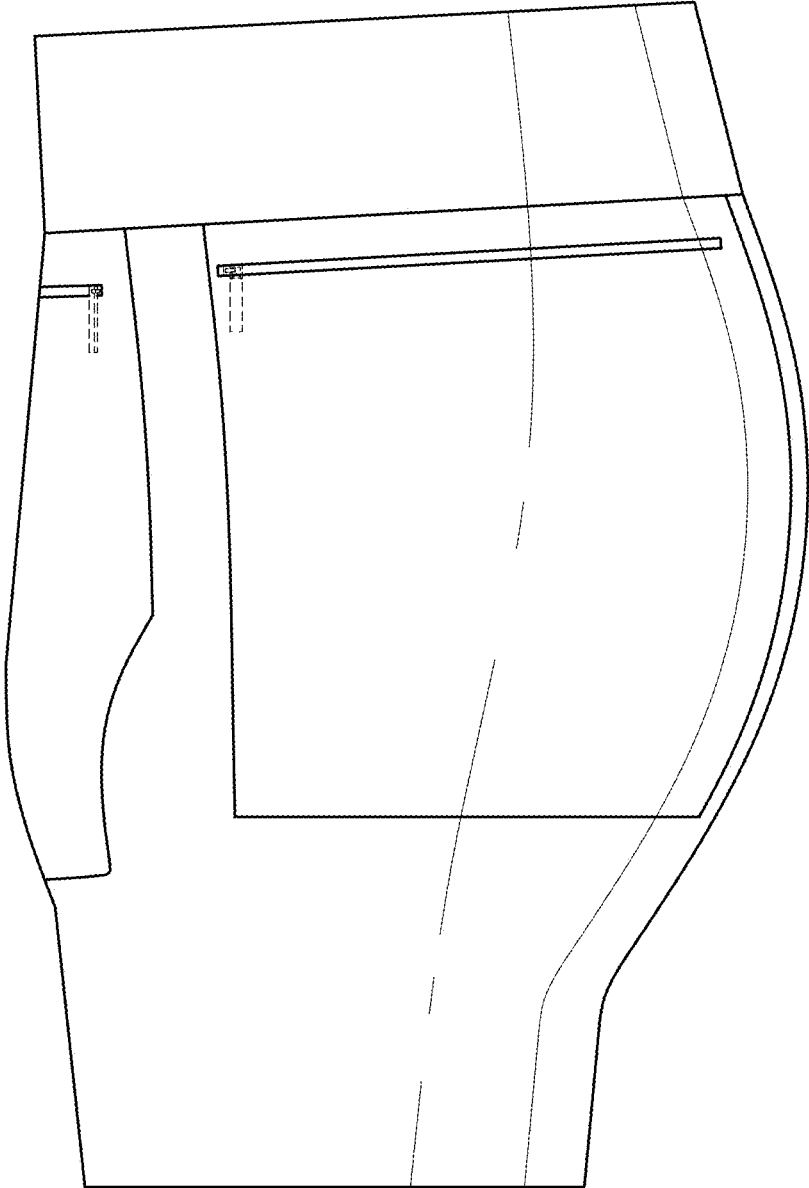

FIG. 12

FIG. 13

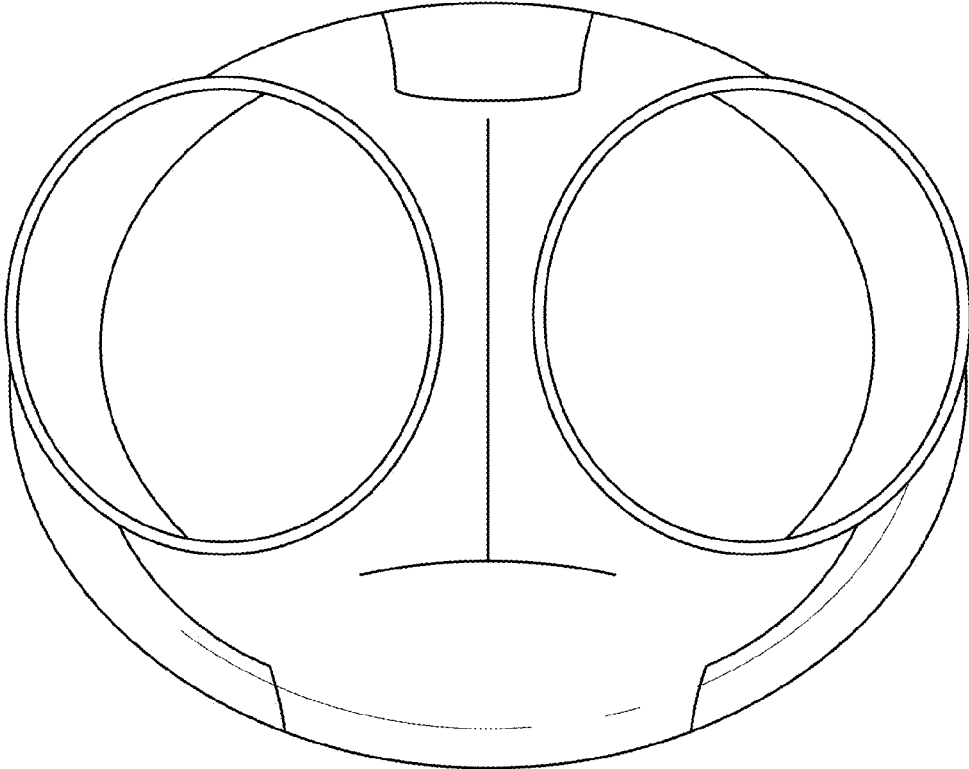
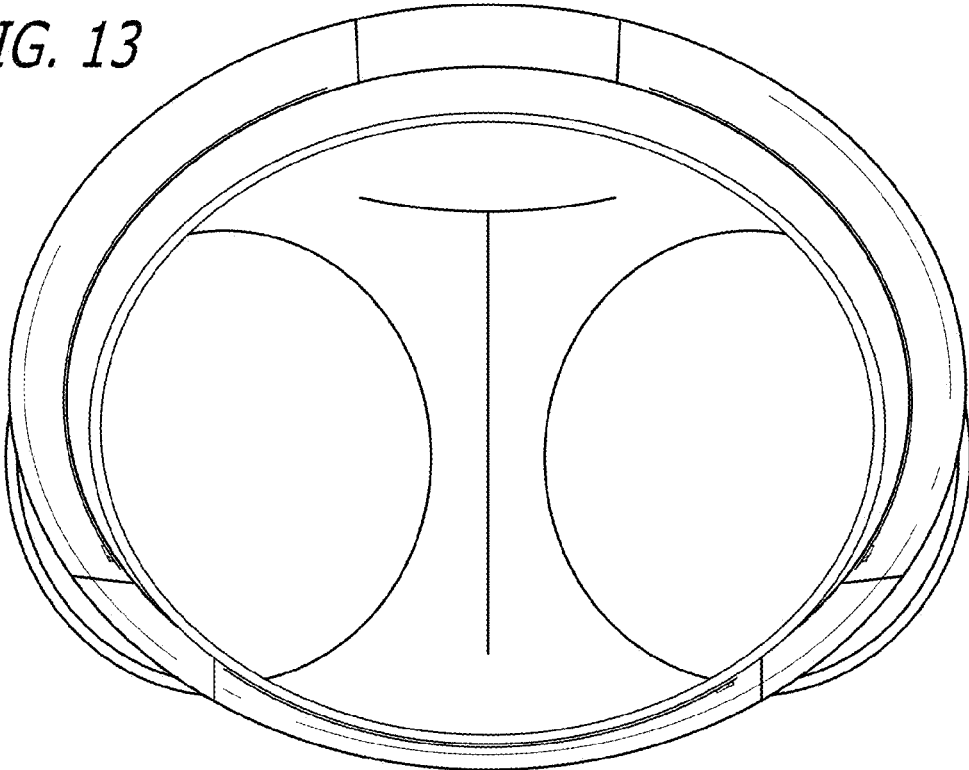

FIG. 14