



US00D910447S

(12) **United States Design Patent**  
**Feletto**

(10) **Patent No.:** **US D910,447 S**

(45) **Date of Patent:** **\*\* Feb. 16, 2021**

(54) **BOTTLE**

(71) Applicant: **VETROELITE SPA**, Ormelle (IT)

(72) Inventor: **Daniele Feletto**, Ormelle (IT)

(\*\*) Term: **15 Years**

(21) Appl. No.: **29/644,240**

(22) Filed: **Apr. 16, 2018**

(30) **Foreign Application Priority Data**

Dec. 7, 2017 (EM) ..... 004539427-0001

(51) **LOC (13) Cl.** ..... **09-01**

(52) **U.S. Cl.**  
USPC ..... **D9/500; D9/520; D9/545**

(58) **Field of Classification Search**  
USPC ..... D9/434, 500, 502-505, 516, 520, 530,  
D9/537, 539, 544-545, 549, 558, 715,  
D9/719

CPC ..... B65D 1/00; B65D 1/02; B65D 1/0223;  
B65D 1/023; B65D 23/00; B65D  
2501/00; B65D 2501/0009

See application file for complete search history.

(56) **References Cited**

**U.S. PATENT DOCUMENTS**

D13,323 S *	9/1882	Winn	.....	D9/500
D118,500 S *	1/1940	Lewis	.....	D9/500
D314,702 S *	2/1991	Gonzalez	.....	D9/667
D470,057 S *	2/2003	Bowen	.....	D9/551
D635,857 S *	4/2011	Lauret	.....	D9/500
D659,538 S *	5/2012	Lecetre	.....	D9/500
D668,955 S *	10/2012	Zuchetta	.....	D9/500
D679,187 S *	4/2013	Zuchetta	.....	D9/500

D679,188 S *	4/2013	Zuchetta	.....	D9/500
D790,967 S *	7/2017	Gonzalez	.....	D9/500
D799,968 S *	10/2017	Harris	.....	D9/500
D811,223 S *	2/2018	Lauret	.....	D9/500
D815,528 S *	4/2018	Lee	.....	D9/500
D818,365 S *	5/2018	Lee	.....	D9/516
D820,090 S *	6/2018	Delbon	.....	D9/500
D821,875 S *	7/2018	Miller	.....	D9/500
D882,406 S *	4/2020	Bulfoni	.....	D9/500
D883,090 S *	5/2020	Feletto	.....	D9/500
D892,618 S *	8/2020	Feletto	.....	D9/500
2018/0253996 A1 *	9/2018	Spiro	.....	B65C 3/14

**OTHER PUBLICATIONS**

“GCM1-3105”, Standard Liquor Finished, Owens-Illinois—  
Distilled Spirits, Wines, & Cordials, 1960—Stock Catalog, Duraglas  
by Owens-Illinois Glass Co., OH, © 1960, p. F.\*

\* cited by examiner

*Primary Examiner* — Dana Meyrow

(74) *Attorney, Agent, or Firm* — Egbert, McDaniel &  
Swartz, PLLC

(57) **CLAIM**

The ornamental design for a bottle, as shown and described.

**DESCRIPTION**

FIG. 1 is a perspective view of a bottle showing my new design.

FIG. 2 is a front view thereof, a rear view being a mirror image thereof;

FIG. 3 is a side view thereof;

FIG. 4 is an opposite side view thereof;

FIG. 5 is a top view thereof; and,

FIG. 6 is a bottom view thereof.

**1 Claim, 5 Drawing Sheets**

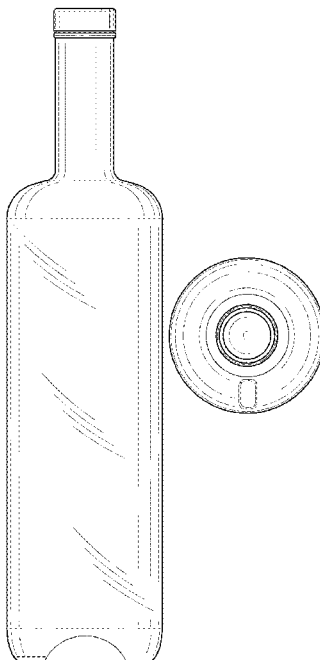

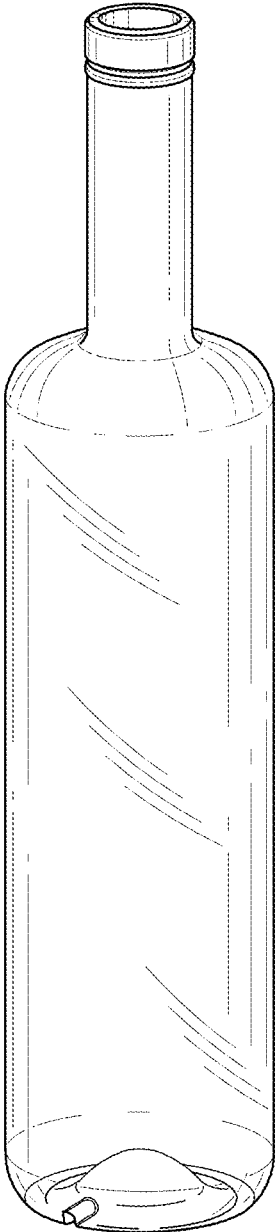

FIG. 1

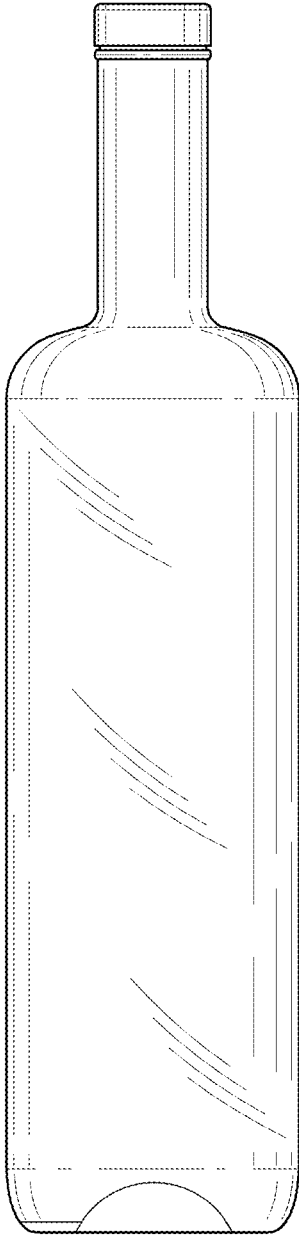

FIG. 2

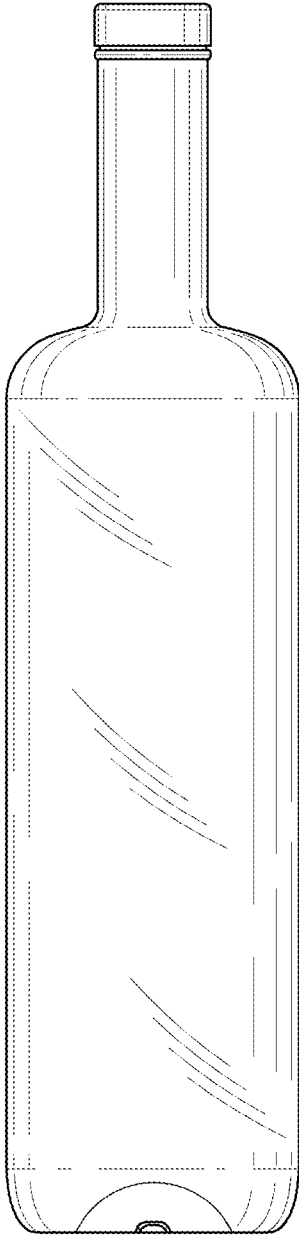

FIG. 3

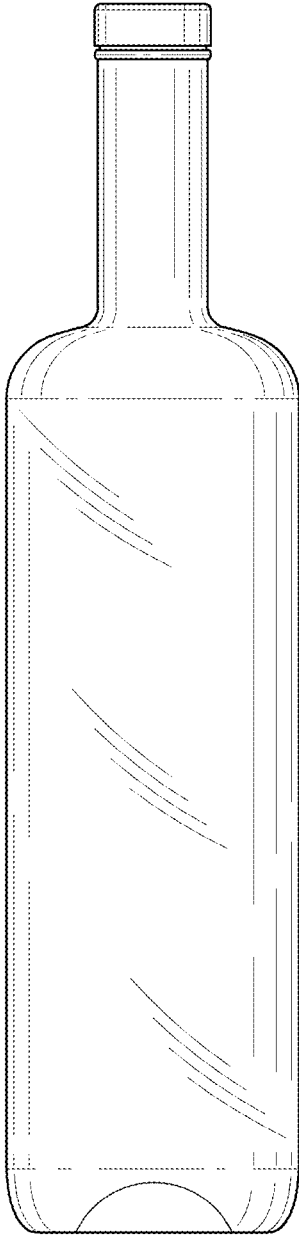

FIG. 4

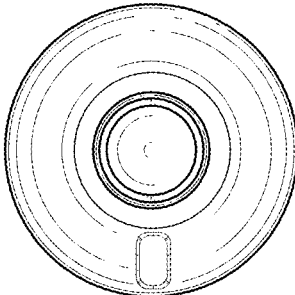

FIG. 5

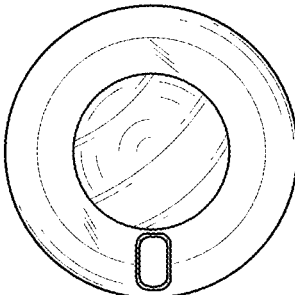

FIG. 6